

REQUEST FOR PROPOSAL

RFP # 984

Allen Creek Railroad Berm Opening Engineering and Assistance

City of Ann Arbor
Public Services Area – Project Management Services Unit



Due Date: October 17, 2016 by 2:00 p.m. (local time)

Issued By:

City of Ann Arbor
Procurement Unit
301 E. Huron Street
Ann Arbor, MI 48104

TABLE OF CONTENTS

SECTION 1- GENERAL INFORMATION..... 3

SECTION II - SCOPE OF SERVICES..... 9

SECTION III - MINIMUM INFORMATION REQUIRED 19

SECTION IV - ATTACHMENTS 23

APPENDIX A: SAMPLE PROFESSIONAL SERVICES AGREEMENT 128

SECTION 1- GENERAL INFORMATION

A. OBJECTIVE

The City of Ann Arbor is requesting proposals from professional civil engineering firms to provide engineering design and grant assistance for the Allen Creek Railroad Berm Opening Project (hereafter "Berm Opening Project").

The City has received a Federal Emergency Management Agency (FEMA) Hazard Mitigation Grant for the design of the Berm Opening Project. The scope of work sought in this Request for Proposal is intended to advance the work conducted under a previous engineering feasibility study ("Feasibility Study"). The Consultant shall manage all aspects of the project design up to the award of the construction contract for the project.

In addition to engineering design and grant assistance, services sought also include survey of the project area, determining a pedestrian access location, assisting the City in acquiring access easements or easement agreements, preparation of a cost estimate, coordination with railroad agencies, and defining and obtaining any necessary environmental clearances needed for a FEMA grant application for construction.

See Section II, Scope of Services, for a detailed task overview.

B. QUESTIONS ABOUT AND CLARIFICATIONS OF THE REQUEST FOR PROPOSAL

All questions regarding this Request for Proposal (RFP) shall be submitted via e-mail. Questions will be accepted and answered in accordance with the terms and conditions of this RFP.

All questions shall be submitted on or before October 7, 2016 at 10:00 a.m.,
and should be addressed as follows:

Scope of Work/Proposal Content questions shall be e-mailed to Anne Warrow,
Project Manager - AWarrow@a2gov.org

RFP Process and Compliance questions shall be e-mailed to Colin Spencer,
Buyer - cspencer@a2gov.org

Should any prospective consultant be in doubt as to the true meaning of any portion of this RFP, or should the consultant find any ambiguity, inconsistency, or omission therein, the consultant shall make a written request for an official interpretation or correction by the due date got questions above.

All interpretations, corrections, or additions to this RFP will be made only as an official addendum that will be posted to a2gov.org and MITN.info and it shall be the consultant's responsibility to ensure they have received all addenda before submitting a proposal. Any addendum issued by the City shall become part of the RFP, and must be incorporated in the proposal where applicable.

C. PRE-PROPOSAL MEETING

A pre-proposal meeting will be held:

WHEN: Tuesday, October 4 at 2:00 p.m – 3:30 p.m.
WHERE: City Hall Building, 2nd floor Council Chambers,
301 East Huron Street, Ann Arbor, Michigan 48107

The meeting is not mandatory, however it is highly recommended that consultants attend the meeting. The purpose of this meeting is to discuss the project with prospective proposers and to answer any questions concerning RFP 984.

Any questions and answers furnished in the pre-proposal meeting will not be official until verified in writing through an addendum.

D. PROPOSAL FORMAT

To be considered, each firm must submit a response to this RFP using the format provided in Section III. No other distribution of proposals is to be made by the consultant. An official authorized to bind the consultant to its provisions must sign the proposal in ink. Each proposal must remain valid for at least ninety days from the due date of this RFP.

Proposals should be prepared simply and economically providing a straightforward, concise description of the consultant's ability to meet the requirements of the RFP. No erasures are permitted. Mistakes may be crossed out and corrected and must be initialed in ink by the person signing the proposal.

E. SELECTION CRITERIA

Responses to this RFP will be evaluated using a point system as shown in Section III. A selection committee comprised of staff from the City will complete the evaluation.

The fee proposals will not be reviewed at the initial evaluation. After initial evaluation, the City will determine top consultants, and open only those fee proposals. The City will then determine which, if any, firms will be interviewed. During the interviews, the selected firms will be given the opportunity to discuss their proposal, qualifications, past experience, and their fee proposal in more detail. The City further reserves the right to interview the key personnel assigned by the selected consultant to this project. If the City chooses to interview any respondents,

the interviews are planned to be held the **week of October 31, 2016**. Prospective Consultant must be available on these dates.

All proposals submitted may be subject to clarifications and further negotiation. All agreements resulting from negotiations that differ from what is represented within the RFP or in the consultant's response shall be documented and included as part of the final contract.

F. SEALED PROPOSAL SUBMISSION

All proposals are due and must be delivered to the City Procurement Unit on, or before, October 17, 2016 at 2:00 p.m. (local time). Proposals submitted late or via oral, telephonic, telegraphic, electronic mail or facsimile **will not** be considered or accepted.

Each respondent must submit in a sealed envelope

- **one (1) original proposal**
- **three (3) additional proposal copies**
- **one (1) digital copy of the proposal preferably on a flash drive as one file in PDF format**

Each respondent must submit in a single separate sealed envelope marked Fee Proposal

- **two (2) copies of the fee proposal**

The fee proposal and all costs must be separate from the rest of the proposal.

Proposals submitted must be clearly marked: **“RFP No.984 – “Allen Creek Railroad Berm Opening Engineering Design, Environmental Review and Clearance, and Grant Preparation Assistance”** and list the consultant's name and address.

Proposals must be addressed and delivered to:

City of Ann Arbor
c/o Customer Service
301 East Huron Street
P.O. Box 8647
Ann Arbor, MI 48107

All proposals received on or before the due date will be publicly opened and recorded on the due date. No immediate decisions will be rendered.

Hand delivered proposals must be date/time stamped by the Customer Service Department at the address above in order to be considered. Delivery hours are 9:00 a.m. to 3:00 p.m. Monday through Friday, excluding Holidays.

The City will not be liable to any consultant for any unforeseen circumstances, delivery, or postal delays. Postmarking on the due date will not substitute for receipt of the proposal. Consultants are responsible for submission of their proposal. Additional time will not be granted to a single consultant. However, additional time may be granted to all consultants at the discretion of the City.

A proposal will be disqualified if:

- 1. The fee proposal is not contained within a separate sealed envelope.**
- 2. The fee proposal is submitted as part of the digital copy. Provide fee proposal in hard copy only.**
- 3. The forms provided as Attachment C - City of Ann Arbor Non-Discrimination Declaration of Compliance, Attachment D - City of Ann Arbor Living Wage Declaration of Compliance, Attachment E - Vendor Conflict of Interest Disclosure Form of the RFP Document must be included in submitted proposals.**

Proposals that fail to provide these completed forms listed above upon proposal opening will be deemed non-responsive and will not be considered for award.

G. DISCLOSURES

Under the Freedom of Information Act (Public Act 442), the City is obligated to permit review of its files, if requested by others. All information in a consultant's proposal is subject to disclosure under this provision. This act also provides for a complete disclosure of contracts and attachments thereto.

H. TYPE OF CONTRACT

A sample of the Professional Services Agreement is included as Appendix A. Those who wish to submit a proposal to the City are required to review the this sample agreement carefully. **The City will not entertain changes to its Professional Services Agreement.**

The City reserves the right to award the total proposal, to reject any or all proposals in whole or in part, and to waive any informality or technical defects if, in the City's sole judgment, the best interests of the City will be so served.

This RFP and the selected consultant's response thereto, shall constitute the basis of the scope of services in the contract by reference.

I. HUMAN RIGHTS REQUIREMENTS

All contractors proposing to do business with the City shall satisfy the contract compliance administrative policy adopted by the City Administrator in accordance with the Section 9:158 of the Ann Arbor City Code. Breach of the obligation not to discriminate as outlined in Attachment B shall be a material breach of the contract.

Contractors are required to post a copy of Ann Arbor's Non-Discrimination Ordinance attached at all work locations where its employees provide services under a contract with the City.

J. WAGE REQUIREMENTS

The Attachments provided herein outline the requirements for payment of prevailing wages or of a "living wage" to employees providing service to the City under this contract. The successful consultant must comply with all applicable requirements and provide documentary proof of compliance when requested.

K. CONFLICT OF INTEREST DISCLOSURE

The City of Ann Arbor Purchasing Policy requires that the consultant complete a Conflict of Interest Disclosure form. A contract may not be awarded to the selected consultant unless and until the Procurement Unit and the City Administrator have reviewed the Disclosure form and determined that no conflict exists under applicable federal, state, or local law or administrative regulation. Not every relationship or situation disclosed on the Disclosure Form may be a disqualifying conflict. Depending on applicable law and regulations, some contracts may awarded on the recommendation of the City Administrator after full disclosure, where such action is allowed by law, if demonstrated competitive pricing exists and/or it is determined the award is in the best interest of the City. A copy of the Conflict of Interest Disclosure Form is attached.

L. COST LIABILITY

The City of Ann Arbor assumes no responsibility or liability for costs incurred by the consultant prior to the execution of a Professional Services Agreement. The liability of the City is limited to the terms and conditions outlined in the Agreement. By submitting a proposal, consultant agrees to bear all costs incurred or related to the preparation, submission, and selection process for the proposal.

M. DEBARMENT

Submission of a proposal in response to this RFP is certification that the Respondent is not currently debarred, suspended, proposed for debarment, and declared ineligible or voluntarily excluded from participation in this transaction by any State or Federal departments or agency. Submission is also agreement that the City will be notified of any changes in this status.

N. PROPOSAL PROTEST

All proposal protests must be in writing and filed with the Purchasing Manager within five (5) business days of the award action. The consultant must clearly state the reasons for the protest. If a consultant contacts a City Service Area/Unit and indicates a desire to protest an award, the Service Area/Unit shall refer the consultant to the Purchasing Manager. The Purchasing Manager will provide the

consultant with the appropriate instructions for filing the protest. The protest shall be reviewed by the City Administrator or designee, whose decision shall be final.

O. SCHEDULE

The proposals submitted should define an appropriate schedule in accordance with the requirements of the Proposed Work Plan in Section III.

The following is the schedule for this RFP process.

Activity/Event	Anticipated Date
Written Question Deadline	October 7, 2016, 10:00 a.m.
Proposal Due Date	October 17, 2016, 2:00 p.m.
Tentative Interviews (if needed)	Week of October 31, 2016
Selection/Negotiations	November 2016
Expected City Council Authorizations	December 2016

The above schedule is for information purposes only and is subject to change at the City's discretion.

P. IRS FORM W-9

The selected consultant will be required to provide the City of Ann Arbor an IRS form W-9.

Q. RESERVATION OF RIGHTS

1. The City reserves the right in its sole and absolute discretion to accept or reject any or all proposals, or alternative proposals, in whole or in part, with or without cause.
2. The City reserves the right to waive, or not waive, informalities or irregularities in terms or conditions of any proposal if determined by the City to be in its best interest.
3. The City reserves the right to request additional information from any or all consultants.
4. The City reserves the right to reject any proposal that it determines to be unresponsive and deficient in any of the information requested within RFP.
5. The City reserves the right to determine whether the scope of the project will be entirely as described in the RFP, a portion of the scope, or a revised scope be implemented.
6. The City reserves the right to select one or more consultants to perform services.
7. The City reserves the right to retain all proposals submitted and to use any ideas in a proposal regardless of whether that proposal is selected. Submission of a proposal indicates acceptance by the firm of the conditions contained in this RFP, unless clearly and specifically noted in the proposal submitted.
8. The City reserves the right to disqualify proposals that fail to respond to any requirements outlined in the RFP, or failure to enclose copies of the required documents outlined within RFP.

SECTION II - SCOPE OF SERVICES

A. OBJECTIVE

The City of Ann Arbor is requesting proposals from a professional civil engineering firm(s) to provide engineering design and assistance with preparing the necessary grant applications and all supporting documentation for the Allen Creek Railroad Berm Opening Project (hereafter “Berm Opening Project”).

The City of Ann Arbor had received a Federal Emergency Management Agency (FEMA) Hazard Mitigation Grant for the design of the Berm Opening Project.

The scope of work sought in this Request for Proposals is intended to advance the work conducted under a previous engineering feasibility study titled, Allen Creek Berm: Feasibility of Flood Reduction and Pedestrian Options, dated December 16, 2013, (“Feasibility Study”), which can be found in Attachment A. The Consultant shall manage all aspects of the environmental review and approval process and project design up to the award of the construction contract for this project.

In addition to engineering design and grant assistance, services sought also include: performing a complete topographical survey of the project area evaluating; collaborating with the City in determining the final pedestrian access location; acquiring access easements or easement agreements; preparation of cost estimates for all needed work and submittals to the various oversight agencies; coordination of all proposed activities with the affected railroad agencies; and defining and obtaining any necessary environmental clearances needed for a FEMA grant application for construction.

B. DESCRIPTION

The railroad berm near the mouth of Allen Creek in the vicinity of Depot Street and Main Street, just west of the Ann Arbor Amtrak Station, is oriented perpendicular to the overland drainage flow pattern and causes the floodplain depth in this area of the City to be as deep as 10 feet during heavy storm events. Upstream of the influence of this berm, flood depths are more typically in the 3 to 5 foot range. .

In December 2013, the City and its consultant completed a Feasibility Study to determine if it was possible to create openings in the railroad berm to accommodate passage of floodwaters and to allow pedestrians to cross the railroad safely via an underground tunnel.

The study determined that such dual openings are feasible and a preferred concept was selected. The complete feasibility study is included in Attachment A.

The Feasibility Study indicated that it is possible to lower the floodplain elevation in the area by as much as 6.5 feet, as well as accommodate non-motorized access under the railroad.

MDOT (railroad owner) is supportive of the preferred alternative provided a shoo-fly rail alignment is constructed to accommodate continuous train passage during all construction activities. It is the City's desire that, post-construction, the bridge constructed for the shoo-fly alignment can remain to provide pedestrian access across the point where the enclosed Allen Creek discharges to the Huron River. In addition, after the removal of the shoo-fly, a key project element will be to construct a pedestrian safety path between this bridge and the pedestrian berm opening.

Two potential pedestrian routes to, and from, the proposed railroad berm opening area were identified, but a preferred route was not determined during the feasibility study. Access issues remain to be studied and resolved at the terminus of those routes.

The City now seeks a consultant to complete engineering design, construction plan and specification preparation, and the assemble of a complete set of bid documents based upon the preferred alternative identified in the feasibility study and the to-be-determined safety path location between the proposed berm opening and the Allen Creek pedestrian bridge.

C. TASKS

All improvements shall be designed in accordance with the applicable AASHTO, City of Ann Arbor, MDOT, MDEQ, ADA, AREMA, Amtrak, and any other relevant standards.

We are now seeking proposals from qualified professional engineering consulting firms to provide the necessary design services for the preparation of plans and specifications to competitively bid and construct these improvements.

In general, the following items will need to be addressed by the consulting firm, in accordance with Section III of this request and the project schedule below.

- 1) The Lead Consultant shall manage all aspects of the project design up to the award of the construction contract(s) for the project. This includes, but is not limited to; managing all aspects of the project, including the work of all sub-consultants and project coordination with all affected agencies. The project manager must ensure the timely and cost-effective delivery of the project design, as well as provide oversight and review of all project deliverables. The Project Manager will be responsible for the overall review and coordination of the contract documents in order to ensure preparation of plans that are detailed, thorough, and accurate and meet all the requirements of the City of Ann Arbor, MDOT, FEMA, Amtrak, MDEQ, and any other agency with oversight responsibilities. This task requires the services of a professional project manager(s) to ensure uninterrupted progress of the project.
- 2) **Review the Feasibility Study Preferred Alternative** – Review the Feasibility Study in detail to gain familiarity with the proposed improvements, proposed location(s), possible pedestrian access routes, and other relevant details. A kick-off meeting with City staff to review the study and confirm the project's objectives will be required.

- 3) **Review and update hydraulic modeling from the Feasibility Study** – Review the City’s calibrated InfoSWMM hydraulic model to provide accurate and defensible hydrographs and all other related information that will be utilized in the preparation of the Pre-disaster Mitigation Grant application and the required Benefit-Cost modeling.
- 4) **Prepare a complete, detailed, ground survey of the entire construction influence area** – The Consultant, as part of the proposal, shall include a detailed drawing delineating the areas, which will be ground surveyed. This survey may be augmented by aerial photography; however, aerial photography will not be the primary tool in developing the topographic survey for the project. At a minimum, survey should include the following elements:
- All survey work shall be performed in accordance with the City of Ann Arbor Public Services Area’s Standards and its Geodetic Control Manual. The Consultant shall complete and submit the City’s Survey Package Submittal Checklist upon completion of all survey work for the City’s review and approval;
 - Locate all trees or shrubs 6” in diameter or greater and provide genus, species, and health breakdown;
 - Locate all cultural features (if any) within the requested survey boundaries;
 - Locate all existing property irons and monuments within the survey limits;
 - Provide a survey with 1’ contour intervals. Survey area shall include:
 - a) Potential pedestrian path areas;
 - b) Area of proposed Depot Street Relief Storm Sewer;
 - c) Railroad right-of-way (including track elevations) within the project limits and at least 100’ past the anticipated tie-in points of the shoo-fly alignment;
 - d) Area across which the storm water discharge will travel to the river;
 - e) Riverbank areas (including existing trees and vegetation) and estimated river bottom elevation at the proposed discharge point of the Huron River; and,
 - f) Any other necessary areas to complete the design;
 - Locate all “breaklines” and any other features as necessary to develop accurate contours;
 - Provide detailed spot elevations at all existing sidewalk and sidewalk ramp areas impacted by the project;
 - Provide all survey work to national map accuracy standards
 - Locate existing public and private utilities in the survey area, determining both horizontal and vertical location;
 - Establish and define the existing right-of-way of the railroad, as well as all streets that are affected by the project; and
 - Create all needed easement descriptions and Exhibit Drawings needed for the chosen pedestrian access path and drainage easements from the railroad and DTE (Detroit Edison) (owner of the property from the railroad to the Huron River) as well as for the Depot Street Relief Storm Sewer. All permanent easement descriptions shall be tied into at least one section corner or other similar permanent survey point.

5) Gather and review information pertaining to existing public and private utilities –

- Determine the precise location, both horizontally and vertically, of all existing utilities.
- Obtain record drawings from the private utility companies where any might be impacted by proposed construction.
- Coordinate all aspects of the proposed work with the private utility companies.
- Where critical crossings of utilities are believed to exist (such as the known fiber optic duct bank on the north side of the railroad right-of-way), or the elevation(s) of existing utilities may significantly affect the proposed design(s), or relocation, of utilities, retaining walls, and the like, test holes shall be dug at all such locations to determine the precise location, both horizontally and vertically, of these points. The Consultant shall arrange for these test holes to be dug and shall arrange to have the necessary inspection and survey personnel on hand to observe, locate, and verify the results of each excavation. The Consultant shall work with MDOT, private utility owners, and MISS-DIG for test holes. The Consultant's proposed budget shall clearly detail the necessary resources to complete this element of this task.

6) Determine preferred pedestrian access location– The feasibility study identified potential pedestrian access routes between the North Main Street and Depot Street intersection area to the pedestrian opening. Taking into consideration grade change, existing site conditions, willingness of affected property owners to grant easements, and the existing and proposed Depot Street Relief Storm Sewer (see attached plan detail), select the most functional and agreeable access location in the vicinity of the identified routes.

Additionally, determine the location for the pedestrian safety path to be constructed between the shoo-fly bridge over Allen Creek and the new pedestrian berm opening under the railroad.

7) Environmental/Historic Preservation – This task shall include:

- Review the environmental documentation related to the Detroit Edison property to gain familiarity with the areas of contamination on that site as they are near the area of the proposed stormwater discharge path from the berm opening culvert to the Huron River. The City also has the results of the complete geotechnical investigation for the Broadway Bridges Reconstruction Project that was performed in 2003/2004 that contains information with regard to the Detroit Edison parcel and the railroad right-of-way adjacent to the project limits. This document is available for review.
- Perform all tasks necessary to complete the environmental/historic preservation requirements of a FEMA Hazard Mitigation and/or Pre-disaster Mitigation Grant for construction of this project.

- Determine what environmental/historic preservation approval will be required from the Federal Railroad Association (FRA) and MDOT in order to construct this project and perform all tasks necessary to obtain such approvals. This may require preparation of categorical exclusions, environmental assessments, environmental impact statements, Section 4(f) evaluations, or other determinations or documents.
 - The Consultant should coordinate and work with all appropriate local, state, and federal entities to ascertain any potential adverse impacts on the environment due to the proposed berm opening, determine any appropriate mitigation measures, and develop documents to support environmental clearance for the opening.
 - The Consultant should be prepared to conduct studies and research based on data or on-site analysis, as needed. The environmental review may require traffic studies, noise and vibration studies, testing for environmental contamination, reviewing environmental records for the presence of hazardous materials, archaeological investigations, wetland delineation, threatened or endangered species and other environmental analytics.
 - The Consultant must evaluate the proposed layout with respect to applicable environmental requirements including: the National Environmental Policy Act (42 U.S.C. 4332); the Council on Environmental Quality's regulations implementing NEPA (40 CFR part 1500 et seq.); and FRA's "Procedures for Considering Environmental Impacts" (45 FR 40854, June 16, 1980, as revised May 26, 1999, 64 FR 28545).
 - The Consultant must evaluate other related laws and regulations such as: Section 4(f) of NEPA, Section 6(f) of the Land and Water Conservation Fund; Section 106 of the National Historic Preservation Act; and applicable requirements of the Clean Water Act and Endangered Species Act.
 - If any of these clearances require public input the Consultant shall work with City Staff to determine the correct procedure.
- 8)** Design live loading for the bridges shall be as determined by the appropriate Railroad Agency. Review and critique proposed sub- and superstructure members from the Feasibility Study. Propose refinements for constructability, cost savings, or other reasons, as necessary.
- 9)** Several retaining walls will be required for this project. The Consultant shall propose a minimum of three different types of wall systems to be used on this project. Also, different retaining wall systems may be used and/or required in different locations or situations (temporary vs. permanent) of the project. The selection criteria shall be based on aesthetics, constructability, and/or cost as appropriate. Further, based on the chosen retaining wall system(s), different colors, textures, geometric patterns, etc. will be sketched and illustrated for comparison purposes in order to assist in making the final choice of a permanent retaining wall system for a given location.

- 10) Perform a complete and detailed geotechnical evaluation and analysis to determine the properties of the existing soils throughout the construction influence area for the purposes of evaluating support soils for the railway, retaining walls, bridges, and culverts.
- 11) **Engineering Design** – Utilizing the preferred alternative from the Feasibility Study and input from City Staff, create final engineering design and construction plans for all project elements. Project elements include, but are not limited to, the following; the pedestrian access paths; temporary shoo-fly rail alignment; proposed berm opening structures (stormwater culvert and pedestrian opening); storm water discharge culvert to the river; the Depot Street Relief Storm Sewer; any necessary retaining or flood walls; and, all related components necessary to construct this project. Tasks include, but are not limited to;
- Revise proposed culvert and Depot Street Relief Storm Sewer size as warranted based on the updated hydraulic modeling and calculation review;
 - The feasibility study indicated a shoo-fly rail alignment would be necessary to divert train traffic during construction operations. MDOT is the owner of the railroad in this area and coordination with them is necessary for all aspects of the opening design, construction methods, and process. Additionally, users of the railroad, such as Amtrak and or Norfolk Southern Railroad, must be a part of the design process. The Consultant will work with the railroads to determine all appropriate railway geometrics meeting current AREMA Standards for the railway design speed as required by MDOT/Amtrak to determine the appropriate length and deflections that accounts for the speed of trains expected at the time of construction. The engineering design plans must include the temporary shoo-fly and temporary bridge over Allen Creek. Bridge design shall also include modifications necessary to convert the shoo-fly bridge into a pedestrian bridge;
 - Determine the optimal design location for the dual berm opening that minimizes shoo-fly length and expense while allowing for safe pedestrian access;
 - Determine the optimal discharge path and method from the berm opening to the Huron River;
 - Determine the optimal path for the Depot Street Relief Storm Sewer;
 - Design of shoo-fly, switches, and bridges shall be in accordance with the current American Railway Engineering and Maintenance-of-Way Association (AREMA) Manual for Railway Engineering;
 - Be prepared to create at least three successive iterative draft designs for review and comment by City Staff, MDOT/Amtrak and other stakeholders.
 - Develop final engineering design and construction plans for all proposed improvements.

- All plan sheets shall be drawn and prepared in accordance with the City of Ann Arbor Public Services Area Drafting Standards. All scales shall be approved by the City of Ann Arbor Project Management Services Unit. The format of the drawings shall be completely compatible with the City's drawing preparation standards and layout(s). The City currently uses AutoCAD 2016 Civil 3D and it is expected that all drawings will be provided in a compatible format without the need to reconfigure drawings for plotting or other purposes.
- 12) **MDEQ and other Permits** – Prepare all permit applications necessary to construct this project. This includes but not limited to, an MDEQ Joint Permit application (Floodplain, Wetlands, Inland Lakes and Streams), MDOT Right-of-Way permits, Washtenaw County Water Resources Commissioner Drain Permit, Amtrak Railroad Permit, Grading Permit, and Soil Erosion and Sedimentation Control Permit.
 - 13) **Cost Estimate Preparation** – Prepare detailed cost estimate(s) for all improvements. Estimate should define which costs are eligible for FEMA grant funding and which are not. This estimate will form the basis for funds sought from FEMA for the Phase 2 construction component of the Hazard Mitigation Grant. The cost estimate will also be utilized in other City grant applications related to the proposed pedestrian facilities.
 - 14) Prepare visual aids and attend at least five public meetings to coordinate the design of the project with other City Departments, City Council, and other formal and informal committees.
 - 15) Prepare complete, detailed, and accurate construction plans and specifications meeting the requirements of the City of Ann Arbor Public Services Area, FEMA, MDOT, AREMA, and Amtrak in order to satisfactorily complete the project.
 - 16) Prepare all plans necessary to meet pertinent City of Ann Arbor requirements. For example, Natural Features Protection Plans, Soil Erosion, Grading, Landscaping and Planting plans, etc. These requirements can be found in Chapter 57 of the City of Ann Arbor Code of Ordinances. The requirements of the City of Ann Arbor Code of Ordinances shall take precedence over all other MDOT standard practices, unless otherwise directed by the City of Ann Arbor.
 - 17) Prepare rendered drawings in order to illustrate the chosen design concept and overall depiction of the project in its finished state. This shall include, at a minimum, a 24" x 36" overall site plan; elevation and section views of each structure and their relationship to the surrounding project elements; elevation and section views of the proposed sidewalks and retaining walls at key locations along the Huron River and Depot Street and/or S. Main Street depending upon the final route chosen for the safety path.

- 18) Identify, define, and prepare all legal descriptions and exhibit drawings for all easements and grading permits that will be required to construct the proposed improvements. This is to include technical assistance, surveying, metes and bounds legal descriptions, and the preparation of the corresponding recordable, exhibit drawings in an 8½" x 11" format, as required and directed by the City. The areas where the expected grading permits and easements are necessary will be determined as the design of the project progresses. Coordinate with City of Ann Arbor personnel such that the appropriate title work and appraisals can be obtained for the purposes of right-of-way and grading easement acquisition. **The City of Ann Arbor will obtain the title work and appraisals needed for the project.** Assist the city in communicating with the five (5) affected property owners as determined by the previous study (DTE Energy, Inc., MDOT, First Martin Corporation, Peter Allen, and Main Street Motors) about the technical aspects of the project. The Consultant shall actively participate in the acquisition of the necessary easements and grading permits by: contacting the affected property owners; attending negotiation meetings; providing technical assistance during the negotiations; and documenting the acquisition process. The documentation shall be in accordance with the Federal Uniform Relocation Assistance and Real Property Acquisition Policies Act of 1970, as amended; the provisions of 23 USC, 23 CFR and 49 CFR; and the provisions of P.A. 1980, No. 87, as amended. The City will be the primary agent for easement or easement agreement negotiations.
- 19) Coordinate **all** elements of the design with all affected parties, including, but not limited to FEMA, FRA, MDOT, MDEQ, Amtrak, Washtenaw County Parks, various City Departments, private utility companies, other formal and informal committees, and the public in general.
- 20) Schedule and chair design progress meetings to be held on a bi-monthly basis. This is to include a design kick-off meeting in which all affected parties to the design will be contacted and invited to attend. Prepare and distribute meeting minutes for all progress and coordination meetings.
- 21) Prepare complete contract documents including plans, specifications, bid forms, etc. to allow the project to be bid either as one project, or as multiple projects, depending on available funding, right-of-way acquisition, and constructability related issues. For the purposes of the preparation of this request, we ask that the Consultant prepare their work plan and schedule around the deliverable and milestone schedule as shown in Table #1.
- 22) **Prepare FEMA Hazard Mitigation Grant Application** – Prepare all required supporting exhibits, cost estimates, or other required materials needed for the City to submit a complete Phase 2 (construction) FEMA grant application.
- 23) **CLOMR and LOMR** – After the design is accepted by FEMA and all other appropriate agencies, the Consultant shall prepare the needed documentation in order to allow the City of Ann Arbor to obtain a Conditional Letter of Map

Revision from FEMA. After construction of the project, a LOMR will be sought. The Consultant shall provide the needed documentation and support to obtain both a CLOMR and LOMR.

Table #1 – Project Schedule

Notice to proceed	01/03/17
Project Kickoff Meeting	01/05/17
30% Design Plans for review by the City and Stakeholders	02/27/17
Easement Agreement Documents - Draft	03/13/17
60% Design Plans for review by the City and Stakeholder	04/03/17
Easement Agreement Documents - Final	04/17/17
Permit submittal application(s)	05/08/17
Environmental Clearance Documentation	05/12/17
90% Design Plans, Specifications and Cost Estimate for review by the City and Stakeholder	06/05/17
Completed Construction Bid Package	07/11/17
FEMA Grant application for Phase 2	08/01/17
Issue ITB for construction contractor	11/06/17
Council Approval of Construction Contract	01/22/18
Begin Construction	02/19/18
Complete Construct project	05/15/19
LOMR Process	06/10/19

- 24) Stakeholder Engagement** - Consultant shall perform stakeholder awareness and involvement strategies throughout the course of the design of the project, including, but not limited to; stakeholder meetings; informational diagrams; e-mail communication; and, other information sharing techniques. The Consultant must effectively communicate the purpose and the benefits of the project with the public and the stakeholders and assist with all necessary negotiations with the affected property owners and public and private agencies. While no formal community engagement plan is required for this project, the Consultant’s Project Manager will maintain open and directed communication with adjacent property owners throughout the design process. The Consultant will provide materials for updating the project website as needed. The project website will be hosted and managed by the City.
- 25) Other Tasks** – In the proposed work plan, Consultant may include any additional tasks, which it deems necessary to advance the project to the Phase 2 FEMA grant application stage. Such additional tasks must be clearly called out in the Proposal and costs of same clearly defined in the sealed Fee Proposal.
- 26) Project deliverables** - The Consultant shall provide the following project deliverables as required throughout the course of the design process as needed to meet all relevant project milestones and/or deliverable dates:

- **Engineering Plans** – Complete construction plans and specifications.
- Provide 30%, 60%, 90% plans for Michigan State Police – Emergency Management review, and FEMA review. These plans shall also be provided to the City of Ann Arbor and all affected agencies for their review and comment as well.
- Provide 100% complete plans, specifications, and cost estimates to the City of Ann Arbor for advertising and bidding the project. Due to multiple funding sources that, most probably, will be involved with this project, the Consultant shall be prepared to prepare the needed project deliverables to either City of Ann Arbor or MDOT Standards. A final decision will be made regarding the appropriate standards after the the project is underway and the project funding scenarios have been finalized.
- **Environmental Deliverables** – All documentation necessary to complete the environmental/historic preservation requirements of a FEMA Hazard Mitigation Grant for construction of this project will need to be submitted. All documentation necessary for any environmental/historic preservation approvals from the Federal Railroad Association (FRA) and MDOT in order to construct this project per Task 7 shall also be submitted to the City.
- **Permit deliverables** - All completed permit applications necessary to construct this project per Task 12 above.
- **Construction Cost Estimate** – A detailed cost estimate per Task 13 above.
- **Easement Agreement Documents** – Legal descriptions and exhibit drawings for all easements that will be required to construct the proposed improvements as set forth in Task 18 above.
- **Project progress and web site materials** – Progress meeting minutes and materials for project website updates shall be prepared on a bimonthly basis as set forth in Tasks 20 and 24 above.
- **Grant Application Materials** – Supporting exhibits, cost estimates, or other required materials needed for the City to submit a complete Phase 2 (construction) FEMA grant application as set forth in Task 22.
- **Electronic Copies of Materials** – The City of Ann Arbor shall be provided with one portable flash drive containing all Project Deliverables and other project related files upon completion of the project's design.
- **Project Billing** - The Consultant shall be aware that all project invoicing must be split between the flood mitigation and the non-motorized project components of the project based upon the actual hours spent. Provide invoices in a format that clearly and concisely details all expenditures on the project in this manner. The City of Ann Arbor reserves the right to request changes to the invoice formatting in order to accurately determine the split and for ease of reimbursement by FEMA.

SECTION III - MINIMUM INFORMATION REQUIRED

PROPOSAL FORMAT

Consultants should organize Proposals into the following Sections:

- A. Professional Qualifications
- B. Past Involvement with Similar Projects
- C. Proposed Work Plan
- D. Fee Proposal (include in a separate sealed envelope clearly marked "Fee Proposal")
- E. Authorized Negotiator
- F. Attachments

The following describes the elements that should be included in each of the proposal sections and the weighted point system that will be used for evaluation of the proposals.

A. Professional Qualifications – 15 points

1. State the full name and address of your organization and, if applicable, the branch office or other subsidiary element that will perform, or assist in performing, the work hereunder. Indicate whether it operates as an individual, partnership, or corporation. If as a corporation, include whether it is licensed to operate in the State of Michigan.
2. Include the name of executive and professional personnel by skill and qualification that will be employed in the work. Show where these personnel will be physically located during the time they are engaged in the work. Indicate which of these individuals you consider key to the successful completion of the project. Identify only individuals who will do the work on this project by name and title. Resumes and qualifications are required for all proposed project personnel, including all subcontractors. Qualifications and capabilities of any subcontractors must also be included.
3. State history of the firm, in terms of length of existence, types of services provided, etc. Identify the technical details that make the firm uniquely qualified for this work.

B. Past involvement with Similar Projects – 30 points

The written proposal must include a list of specific experience in the project area and indicate proven ability in implementing similar projects for the firm **and** the individuals to be involved in the project.

A complete list of client references must be provided for similar projects recently completed. It shall include the firm/agency name, address, telephone number, project title, and contact person.

C. Proposed Work Plan – 45 points

A detailed work plan shall list all tasks determined to be necessary to accomplish the work of this project. The work plan shall define resources needed for each task (title and individual person hours) and the firm's staff person completing the project task. In addition, the work plan shall include a timeline schedule depicting the sequence and duration of tasks showing how the work will be organized and executed.

1. The work plan shall be sufficiently detailed and clear to identify the progress milestones (i.e., when project elements, measures, and deliverables are to be completed) and the extent and timing of the City personnel involvement. Additional project elements suggested by the Proposer are to be included in the work plan and identified as Proposer suggested elements.
2. The work plan must identify information the Proposer will need from City staff in order to complete the project. Include estimated time and resource commitment from City staff.
3. The work plan shall include any other information that the Proposer believes to be pertinent but not specifically asked for elsewhere.
4. Also include in the work plan proposed steps, if any, to expedite completion of the project. This will be given due consideration during evaluation of proposals.

Consultants shall be evaluated on the clarity, thoroughness, and content of their responses to the above items.

D. Fee Proposal - 10 points

Fee quotations shall be submitted in a separate sealed envelope as part of the proposal. Fee quotations are to include the names, title, hourly rates, overhead factors, and any other details, including hours of effort for each team member by task, by which the overall and project element costs have been derived. The fee quotation is to relate in detail to each item of the proposed work plan.

Consultants shall be capable of justifying the details of the fee proposal relative to personnel costs, overhead, how the overhead rate is derived, material and time.

The fee proposed must include the total estimated cost for the project when it is 100% complete. This total may be adjusted after negotiations with the City and prior to signing a formal contract, if justified.

E. Authorized Negotiator

Include the name, phone number, and e-mail address of persons(s) in your organization authorized to negotiate the agreement with the City

F. Attachments

Legal Status of Consultant, Conflict of Interest Form, Living Wage Compliance Form, and the Non-Discrimination Form must be completed and returned with the proposal. These elements should be included as attachments to the proposal submission.

PROPOSAL EVALUATION

1. The selection committee will evaluate each proposal by the above-described criteria and point system (A through C) to select a short-list of firms for further consideration. The City reserves the right to reject any proposal that it determines to be unresponsive and deficient in any of the information requested for evaluation. A proposal with all the requested information does not guarantee the proposing firm to be a candidate for an interview. The committee may contact references to verify material submitted by the consultants.
2. The selection committee shall open the sealed fee schedules for the short-list of firms. The fee schedules will be evaluated by the above-described criteria and point system for Item D. The selection committee shall then select a firm or firms that will be invited to interview.
3. The committee then will schedule interviews with the selected firms if necessary. The selected firms will be given the opportunity to discuss in more detail their qualifications, past experience, proposed work plan and fee proposal.
4. The interview must include the project team members expected to complete a majority of work on the project, but no more than six members total. The interview shall consist of a presentation of up to thirty minutes (or the length provided by the committee) by the consultant, including the person who will be the project manager on this contract, followed by approximately thirty minutes of questions and answers. Audiovisual aids may be used during the oral interviews. The committee may record the oral interviews.
5. The firms interviewed will then be re-evaluated by the above criteria (A through C), and adjustments to scoring will be made as appropriate. After evaluation of the proposals, further negotiation with the selected firm may be pursued leading to the award of a contract by City Council, if suitable proposals are received.

The City reserves the right to waive the interview process and evaluate the consultants based on their proposals and fee schedules alone.

The City will determine whether the final scope of the project to be negotiated will be entirely as described in this RFP, a portion of the scope, or a revised scope.

Any proposal that does not conform fully to these instructions may be rejected.

PREPARATION OF PROPOSALS

Proposals should have no plastic bindings but will not be rejected as non-responsive for being bound. Staples or binder clips are acceptable. Proposals should be printed double sided on recycled paper. Proposals should not be more than 50 sheets (100 sides), not including required attachments and resumes.

Each person signing the proposal certifies that he or she is the person in the consultant's firm/organization responsible for the decision as to the fees being offered in the Proposal and has not and will not participate in any action contrary to the terms of this provision.

ADDENDA

If it becomes necessary to revise any part of the RFP, notice of the addendum will be posted to Michigan Inter-governmental Trade Network (MITN) www.mitn.info and/or the City of Ann Arbor web site www.A2gov.org for all parties to download.

Each consultant must acknowledge in its proposal all addenda it has received. The failure of a consultant to receive or acknowledge receipt of any addenda shall not relieve the consultant of the responsibility for complying with the terms thereof. The City will not be bound by oral responses to inquiries or written responses other than official written addenda.

SECTION IV - ATTACHMENTS

Attachment A – Allen Creek Berm: Feasibility of Flood Reduction and Pedestrian Options, dated December 16, 2013

Attachment B - Legal Status of Respondent

Attachment C – Non-Discrimination Ordinance Declaration of Compliance Form

Attachment D – Living Wage Declaration of Compliance Form

Attachment E – Vendor Conflict of Interest Disclosure Form

Attachment F – Non-Discrimination Ordinance Poster

Attachment G – Living Wage Ordinance Poster

ATTACHMENT A
ALLEN CREEK BERM: FEASIBILITY OF FLOOD REDUCTION AND PEDESTRIAN
OPTIONS, DATED DECEMBER 16, 2013

technical memorandum

Date: December 16, 2013

To: Jerry Hancock, City of Ann Arbor
From: Greg Kacvinsky, OHM Advisors

Re: Allen Creek Berm: Feasibility of Flood Reduction and Pedestrian Options

Purpose of Study

The City of Ann Arbor retained OHM Advisors to review options to lower the floodplain through the lower reaches of Allen Creek in the vicinity of the Depot Street and North 4th Avenue, just west of the Ann Arbor Amtrak station.

This study is being performed to determine the feasibility and preliminary costs of implementing hydraulic improvements and creating pedestrian access under the railroad to a future multi-use development along the Huron River, and to help secure FEMA Pre-Disaster Mitigation Funding.

Key Findings

1. The existing official (FEMA) floodplain elevation in the lower reaches of Allen Creek threatens numerous homes and businesses (see Figure 1).
2. The existing Allen Creek enclosure, a 90-year-old concrete arch culvert (14-foot span and 8.5-foot rise through the project area), has a full pipe capacity of approximately 1,200-1,300 cfs, which is only about 50% of the official 1% storm (100-year recurrence interval) peak flow rate of 2,395 cfs at the downstream end of Allen Creek. The full pipe capacity of the Allen Creek enclosure is roughly equivalent to the peak flow generated by a 50% storm (2-year recurrence interval), as predicted by the City's SWMM model.
3. The interior condition of the Allen Creek enclosure, based on a March 2013 inspection by the Washtenaw County Water Resources Commissioner (WCWRC), indicates that the interior condition of the Allen Creek enclosure is generally favorable, with the exception of minor structural defects at joints/bulkheads and a minor storm sewer lateral protrusion. Based on the report (included in Appendix A), there does not appear to be any significant hydraulic limitation due to pipe failures, obstructions, or miscellaneous debris.
4. The 1% storm (100-year) floodplain elevation of the Huron River is well below the Allen Creek enclosure flood elevations and has no impact on the recommendations in this study.

5. Increasing peak flow to the Huron River, by way of hydraulic improvements as recommended in this study, should have a negligible impact on the Huron River peak flow rates, as the relative watershed areas (5.5 square miles for Allen Creek versus 730 square miles for the Huron River) vary widely and there is a very low probability of coincidental peak flows between the two watersheds.
6. This project should help to reduce pollution potential, as the reduction in flood levels will minimize the probability of co-mingling stormwater with vehicles. This will help to minimize the chances of volatile organic compounds (VOCs), such as oils and fuel, reaching the Huron River.
7. Under all proposed improvement scenarios, the total peak flow to the Huron River would increase due to the loss of floodplain storage south of the railroad tracks. Based on the assumed existing 1% storm peak flow of 2,395 cfs, the proposed improvements would increase peak flows by approximately 9% (from 2,395 cfs to about 2,600 cfs). However, as the proposed improvements will eliminate the extended period of increased flows (as the flooded area slowly recedes under existing conditions), it could be argued that this project will help to *reduce* the peak flow in the Huron River by reducing the flow rates in the receding limb of the Allen Creek flow hydrograph.
8. The Benefit-Cost Analysis (BCA) tool reveals that all alternatives should have a Benefit-Cost Ratio (BCR) above 1.0. This should provide the City with the option of applying for FEMA Pre-Disaster Mitigation Funding, pending FEMA's review and approval of the BCA referenced in this document. At this time, it is not known whether the federal government will be funding this grant program in FY2014 or subsequent years due to significant budget changes at FEMA that have impacted the agency's disaster mitigation grant program.
9. Based on coordination with the MDOT Office of Rail, there is concern about how these improvements will impact pedestrian safety in the vicinity of the railroad right-of-way. MDOT appears to be amenable to a hydraulic improvement. The project alternative that meets MDOT's early feedback is highlighted in this report as the Preferred Alternative.
10. Other options of safely conveying the Allen Creek floodwaters, such as increasing the size of the Allen Creek enclosure or creating another underground (parallel) conveyance system are not feasible, given existing land use in the area and the higher costs associated with such an improvement.

Key Recommendations

1. Install one of the alternatives listed in Table 1 (Project Alternative Summary). Each proposed project alternative will lower the 1% storm floodplain by approximately 6.5 feet (from 779.5 to 773.0) and significantly reduce the potential for property damage due to flooding. These alternatives are based on feedback received after coordination with area property owners, three meetings with the Technical Advisory Committee, a public meeting, and coordination with the MDOT Office of Rail on constructability issues related to ongoing rail users' needs. The selected improvement will result in the following approximate flow split between the Allen Creek enclosure and the flood relief culvert:

- | | |
|---------------------------|---------------------------------------|
| a. Allen Creek enclosure: | 1,600 cfs (62% of 1% storm peak flow) |
| b. Flood relief culvert: | 1,000 cfs (38% of 1% storm peak flow) |

Although the costs between the alternatives vary significantly, there are key differences in total public benefit, including whether the improvement can accommodate pedestrians. The

City and key stakeholders will need to determine which option provides the greatest long-term benefit to the community. ***Based on feedback received from project stakeholders, the Preferred Alternative is a variation on Alternative 3.***

2. Apply for a FEMA Pre-Disaster Mitigation Grant. All project alternatives in this study have BCRs above 1.0. Additional effort will be required to refine the input/output in the BCA tool in order to complete the grant application.
3. The City's ongoing stormwater modeling effort should focus on significant improvements to the Allen Creek InfoSWMM model, including:
 - a. Add flood storage volumes to upstream areas to adequately represent flow attenuation due to street flooding along the Allen Creek enclosure.
 - b. Add overland flow routes to create a "dual drainage" model in which floodwaters are adequately modeled towards the outlet of Allen Creek.
 - c. Verify appropriate roughness coefficients and junction losses along the Allen Creek enclosure. High flow velocities will make the model sensitive to these variables.
4. Given the age of the Allen Creek enclosure and its criticality as a primary flood conveyance asset, the City should coordinate with the WCWRC to provide regular interior inspections of the Allen Creek and make appropriate repairs so as to extend the life of this asset. This inspection should be extended further upstream through downtown Ann Arbor. The inspection frequency should be 3-5 years. Typical maintenance may include joint/bulkhead mortar repair and sealing, lateral and manhole connection repairs, and removal of obstructions. This increased level of inspection and maintenance should extend the life of the asset and delay costly removal and replacement projects.
5. Additional funding sources (beyond the FEMA Pre-Disaster Mitigation Funding) that may provide financial support for the capital improvement recommendations in this document include:
 - a. MDEQ SAW (**S**tormwater / **A**sset Management / **W**astewater) Grants: the SAW grants will be available with the initial grant application release around August 2013 (first round of applications due October 1, 2013). This grant could be applied to planning and design for stormwater projects, including additional inspection costs for upstream components of the Allen Creek enclosure, as well as design costs for flood control projects should the FEMA grant funding be unavailable to cover this effort.
 - b. MDEQ Brownfields Redevelopment Grants: Funds are targeted toward projects that promote economic development and brownfield property reuse. Cleanup *grants* may be used at properties with known contamination and specific redevelopment proposals and where measurable economic benefits will exceed the grant amount while cleanup *loans* may be provided at properties with suspected contamination where there is economic development potential based on a planned reuse.
 - c. MDNR Recreational Trails Program (RTP): Provides funding for the maintenance and development of recreational trails and related facilities. Only state and state/local government partnership projects are eligible and a division within the MDNR must always be the applicant. Local projects can be considered for funding if they contribute to MDNR program goals and are located on MDNR land or linked to a trail on MDNR land.
 - d. MDOT TAP: The National Transportation Alternatives Program (TAP) provides funding for construction, planning, and design of trail facilities for non-motorized transportation. MDOT TAP is a competitive program with funding for pedestrian

and bicyclist facilities that provide non-motorized amenities that increase usability of non-motorized facilities, accomplish multiple goals (tied with other initiatives/infrastructure work, water quality improvements, etc.), or provide views of highly unique and scenic areas.

6. Apply for a FEMA Letter of Map Revision (LOMR) for the project area after the following milestones have been achieved:
 - a. The InfoSWMM model for Allen Creek has been updated and fully-calibrated, and;
 - b. The hydraulic improvement alternative selected by the City has been designed and constructed.

We do not recommend submitting a LOMR prior to the improvements, as the adjusted floodplain elevation could adversely impact the City's ability to achieve a favorable Benefit-Cost Ratio for FEMA grant funding consideration.

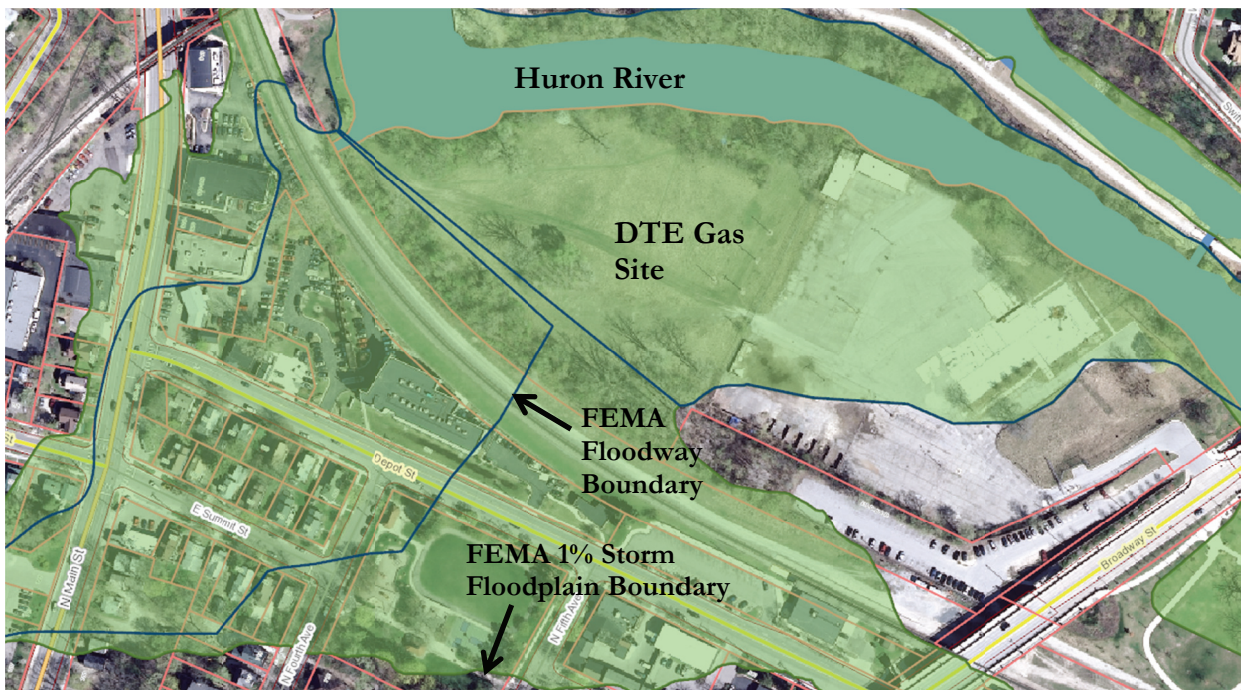

Figure 1
Project Area and Floodplain/Floodway Boundaries

**Table 1
Project Alternative Summary**

Alternative	Description	Cost	Pros	Cons
1	Hydraulic relief without pedestrian access. 54-inch sewers with drop structure at north edge of 201 Depot parking lot. Discharges to twin 4' x 8' box culverts north of railroad.	\$2.2 million	Provides flood relief at the most remote location with the most direct and shortest route to Huron River. No disruption to rail traffic (pipes would be inserted by jacking and boring). Same for Alternative 1a below.	No pedestrian access. The upstream drop structure and downstream flow transition structure will be large and will require safety grating to prevent public access. High flow velocities in the enclosed sewer will require energy dissipation prior to discharge to the Huron River.
1a	Same as Alternative 1 but with an open channel downstream of railroad (in lieu of twin box culverts).	\$1.9 million	Most cost-efficient alternative, with similar pros to Alternative 1. Open channel reduces cost and provides a water quality benefit prior to discharge to the Huron River.	No pedestrian access. The upstream drop structure will be large and will require safety grating to prevent public access.
2	Hydraulic relief without pedestrian access. 48-inch sewers with at-grade inlet south of railroad, discharging to twin 4' x 8' box culverts north of railroad.	\$2.6 million	Provides flood relief without a large upstream concrete drop structure. No disruption to rail traffic (pipes would be inserted by jacking and boring). Same for Alternative 2a below.	No pedestrian access. The downstream flow transition structure will be large and will require safety grating to prevent public access. High flow velocities in the enclosed sewer will require energy dissipation prior to discharge to the Huron River.
2b	Same as Alternative 2 but with an open channel downstream of railroad (in lieu of twin box culverts).	\$2.1 million	Second-most cost-efficient alternative. Open channel reduces cost and provides a water quality benefit prior to discharge to the Huron River.	No pedestrian access. Same drawbacks as Alternative 2 above.
3	Flood control and pedestrian access: Culvert Alternative. One lower culvert for flood conveyance, and one higher culvert for pedestrian access. Flood wall prevents flood waters from entering pedestrian culvert.	\$3.9 million	Provides pedestrian access and flood control. A more cost-efficient alternative than the trestle bridge (Alternate 4 below).	More expensive than Alternatives 1/1a and 2/2a. Requires construction of a shoo-fly to route rail traffic during construction.
4	Flood control and pedestrian access: Trestle Bridge Alternative. Large opening provides room for flood conveyance and pedestrians. A flood wall separates flow component from pedestrian access.	\$5.0 million	Provides pedestrian access and flood control. 2-span structure provides a more natural and open connection between the north and south sides of the railroad.	Most expensive alternative. Large structure required for bridge span limits headroom for pedestrians and flood wall offsets the "open" feel provided by a 2-span bridge. Requires construction of a shoo-fly to route rail traffic during construction.

Technical Approach – EPA SWMM Modeling

The findings and recommendations in this report are based on a modified EPA SWMM model that is based on the City’s uncalibrated InfoSWMM model. At the time this project occurred, the calibrated model for Allen Creek was not yet available.

In selecting the appropriate hydraulic modeling tool, OHM Advisors first reviewed the HEC-RAS model used for the 2012 update of the FEMA Flood Insurance Study. After our review of the HEC-RAS model, we determined that HEC-RAS was not an appropriate tool for this project due to the following reasons:

- HEC-RAS is a surface flow model and does not account well for flow through pressurized channels (i.e. Allen Creek enclosure)
- The HEC-RAS model used for the Flood Insurance Study significantly underestimates the flow capacity of the Allen Creek enclosure.
- The cross sections representing the overland flow do not match up well to GIS contour or LIDAR data.

In order to determine the appropriate hydrologic response (i.e. peak flow), the OHM Advisors team, in consultation with the TAC, decided that the official FEMA published peak flow rates should be used in calculating the impacts of proposed hydraulic improvements. As such, the following peak flow rates were used for this project:

Table 2
Peak Flow Rates* for Allen Creek Berm Study

Annual Flow Exceedance Probability	Peak Flow Rate (cfs)
10%	1,686
2%	2,142
1%	2,395
0.2%	3,428

* Source: FEMA Flood Insurance Study, Washtenaw County, MI (April 2012)

The City-supplied EPA SWMM model of the Allen Creek watershed, based on the uncalibrated InfoSWMM model, included the majority of the basic hydraulic components necessary to conduct this study. However, the hydrologic response from the EPA SWMM model varies significantly from the official FEMA flow rates listed in Table 2, which is largely due to the fact that the hydrologic calibration has not yet taken place.

As the TAC agreed that the FEMA peak flows were appropriate for this analysis, the flow hydrograph from the EPA SWMM model of Allen Creek was manually adjusted to provide the same overall hydrograph shape, but with a peak flow matching that of the FEMA study. Figure 2 illustrates the difference between the EPA SWMM runoff response and the adjusted hydrograph to match the FEMA peak flow rate for the 1% storm.

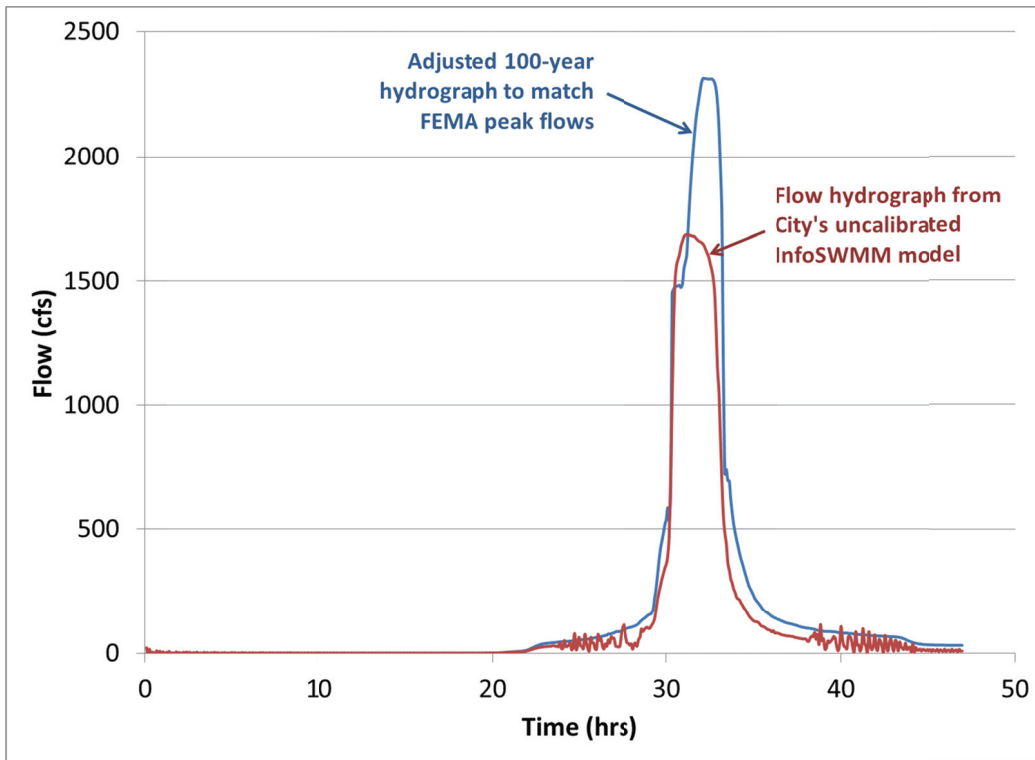

Figure 2
Hydrograph Modification to Match FEMA Flow Rates
1% Storm (100-year recurrence interval)

The City-provided EPA SWMM model was truncated to include only the hydraulic components within the project area. This was done to reduce model computation time and to eliminate model components that have no impact on this study. To ensure that the truncated model is reflective of the larger (complete) Allen Creek model, the flow hydrograph and hydraulic profile of the Allen Creek enclosure were compared between the City-provided EPA SWMM model and the OHM-truncated EPA SWMM model. This test confirmed that the two models resulted in equivalent output data and therefore the truncated model was considered valid for use in the alternatives analysis. The truncated model schematic is illustrated in Figure 3.

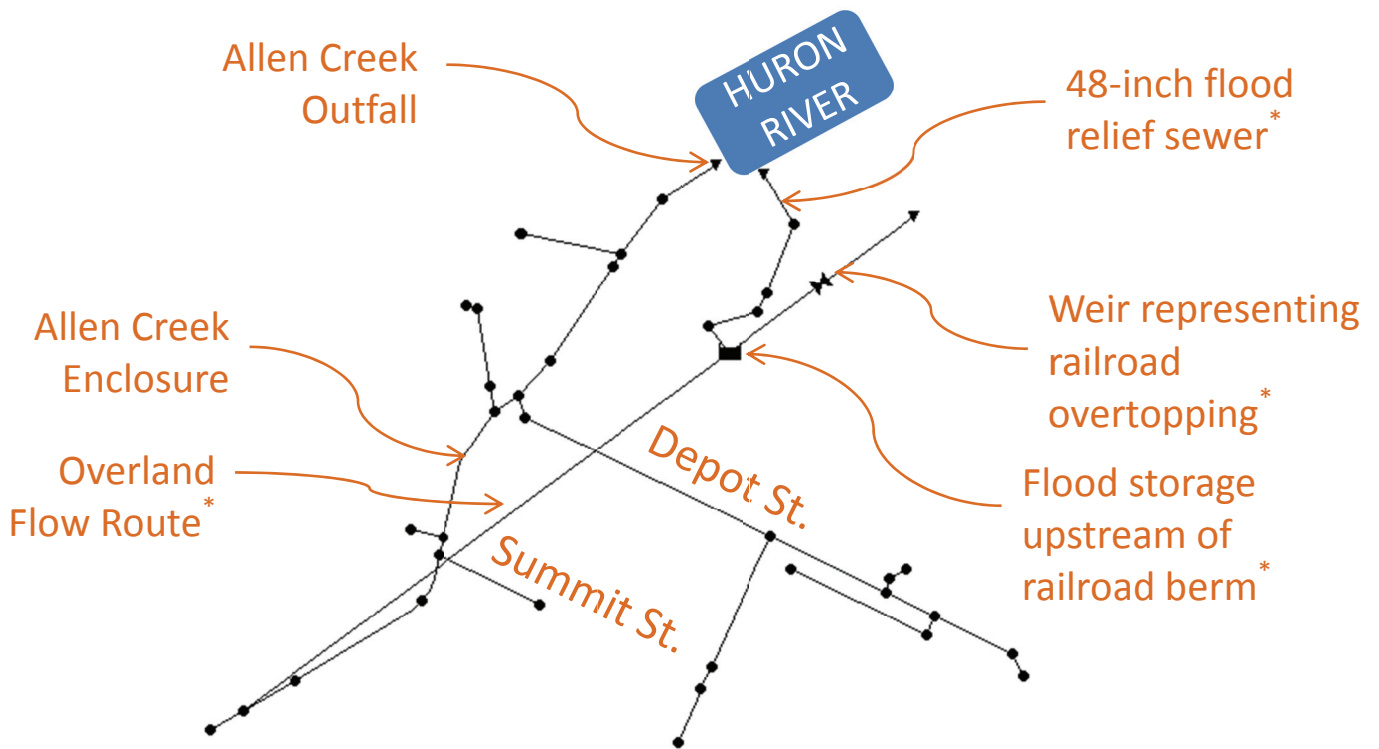

Figure 3
Truncated EPA SWMM Model

** These model components were added by OHM Advisors in order to adequately represent the flow dynamics present in the project area.*

The key findings from the modeling effort revealed the following about the project area:

- The existing Allen Creek enclosure has a full pipe capacity of approximately 1,200-1,300 cfs, which is only about 50% of the official 1% storm peak flow rate of 2,395 cfs at the downstream end of Allen Creek. Higher flows are only possible when the Allen Creek enclosure is under additional hydraulic pressure resulting from flooding in the project area.
- The existing Allen Creek enclosure, within the project area, can convey the flows resulting from a 50% storm (2-year recurrence interval) under gravity (non-pressure) conditions. Flow events exceeding the 50% storm will cause surcharging and reverse flow along Depot Street, thereby exacerbating surface flooding conditions in the vicinity of 201 Depot.
- The primary flow component entering the flood-prone area upstream of the railroad tracks is overland flow (flood routing) across the Summit / Main intersection. This flow component (approximately 50% of the official 1% storm peak flow rate) cannot be conveyed in the Allen Creek enclosure and therefore seeks the best surface flood route, which terminates at 201 Depot.

Railroad Coordination

Our subconsultant, Bergmann Associates, engaged the Michigan Department of Transportation (MDOT), as they took ownership of the railroad through the project area in early December 2012. As the railroad will play a key role through the design and construction phases of this project (as well as long-term maintenance and inspection), it was necessary to involve them early to determine their constraints for the following:

- Pedestrian access and safety along and within the railroad right-of-way
- Impact of floodplain reduction on the railroad, including any quantifiable economic impacts
- Potential for temporary disruption of rail traffic to accommodate culvert construction and/or future maintenance and inspection activities
- Temporary track realignment (shoo-fly) to accommodate continuous rail service during construction (if temporary disruption is not feasible)

Both the consultant team and City staff had separate conversations with MDOT Office of Rail representatives. There are several key concerns that will impact the feasibility of the improvement alternatives referenced in this report. The primary issues are:

- Maintaining separation between area pedestrians and rail traffic, both of which are expected to increase due to high speed rail upgrades and planned land development at the DTE Gas site.
- Pedestrian safety within the MDOT right-of-way (through an underpass as proposed in this document) may be compromised during significant wet weather events and at night if adequate lighting is not provided and adequately maintained. Although MDOT officials are concerned about the liabilities associated with pedestrian safety within their right-of-way, they are amenable to a pedestrian alternative, provided that maintenance agreements can be worked out between MDOT and the City.
- They hydraulic-only alternatives must include provisions to prevent/discourage anyone from entering the culverts. For Options 1/1a and 2/2a, this would likely include bar grates at ends of pipes, metal grating at concrete drop structures, and vegetative screening to keep the areas hidden from view.

A summary of railroad issues related to this project, including summaries of direct conversations with MDOT Office of Rail representatives, are summarized in Appendix B.

DTE Gas Property

OHM Advisors and City staff met with representatives from DTE Gas (formerly Michcon) in early January 2013 to discuss the proposed hydraulic improvement alternatives and how it may impact their property north of the railroad tracks (between the tracks and the Huron River). The following key issues and concerns were raised at this meeting:

- DTE Gas would prefer an enclosed drainage system through their property, as it provides more flexibility for site planning. DTE Gas representatives were concerned how an open channel configuration would look and whether it would create a public safety / nuisance issue on their property.
- The City may have leverage with the development characteristics on the west side of the DTE Gas site, so there may be some flexibility on the ultimate design of the hydraulic outlet.

- It may be ideal to follow the alignment of the existing 48-inch storm sewer at the west edge of the property, as the soil conditions in this area are better known and it would minimize disruption to the site.
- There are pockets of contaminated soil throughout the site. Any improvement related to the railroad berm project (i.e. open channel or enclosed system) would likely require the removal and disposal of hazardous materials.
- It will be important to prevent a groundwater-surface water interface (GSI) with the proposed hydraulic outlet. If an open channel is constructed, a cap (clay or concrete) will likely be necessary to contain contaminated groundwater and prevent it from flowing to the Huron River. If an enclosed pipe/culvert is constructed, anti-seep collars will be necessary to prevent the migration of groundwater through the trench backfill to the Huron River. Either alternative will need to consider the additional cost related to these anti-GSI measures.
- The proposed hydraulic outlet will impact the recently-installed tree mitigation bank. Any disturbed trees will need to be replanted.

Additional Project Area Stakeholders

OHM Advisors and City staff met with Mike Martin to discuss the potential project alternatives. This meeting was scheduled with Mr. Martin as his properties coincide with the most severe flooding areas and the proposed solutions are all located at 201 Depot, which is owned and operated by Mr. Martin. The summary of this meeting is included in Appendix C.

OHM Advisors and City staff met with Peter Allen to discuss pedestrian access options from his properties west and northwest of 201 Depot. Mr. Allen expressed support for providing an access easement through his property, provided that it did not interfere with parking or traffic flow. Two access points were discussed: one from N. Main Street and one from Depot Street. The Depot Street connection would require coordination with both Mike Martin and Peter Allen, as it would cross through multiple properties. Both of the pedestrian options discussed with Mr. Allen would likely require parking lot reconfiguration to provide adequate access and safety for pedestrians. Figure 10 illustrates one of the alternate pedestrian connection options through Mr. Allen's property.

Groundwater Impacts

City staff and WCWRC representatives indicated that high groundwater has been a concern in the project area. The actual depth of groundwater has been documented through soil borings for recent utility construction projects as well as long-term groundwater monitoring on the DTE Gas site. The most recent and relevant report is the June 2012 Groundwater Contour Map developed for DTE Gas by TRC Environmental Corporation. This report reveals that the predominant groundwater elevation in the area of the proposed improvements is at or about elevation 762.0 – 762.5, which is approximately level with the Huron River normal water surface elevation downstream of Argo Dam. This elevation is consistent with soil boring logs reviewed by OHM Advisors.

The proposed improvements detailed in this document have a flow line elevation (under the railroad) of about 763.5, which is above the observed groundwater elevation.

Benefit-Cost Analysis

The FEMA Benefit-Cost Analysis (BCA) tool, version 4.5.5.0, was used to calculate the economic benefit of floodplain reduction for the varying hydraulic alternatives studied as part of this project. This BCA tool is a Windows-based software tool that is used to collect data on structures within the

existing floodplain in order to quantify expected annual losses based on the probability of flooding levels for a wide range of events (1-year through 500-year recurrence intervals).

Key data used for the BCA tool included:

- Residential properties:
 - First floor elevation (surveyed as part of this project)
 - Assessed value (based on County records)
 - Area of first floor (based on County records)
- Commercial properties:
 - Replacement value of commercial facilities exposed to floodplain
 - Business income estimates were not used as we did not have access to this information
 - Estimates of vehicle losses due to parking lot flooding (most applicable to 201 Depot and adjacent properties)
- Critical facilities (public facilities critical for serving the needs of the public)
 - Railroad and Amtrak station (cost of rail service disruption due to flooding of tracks)
- Reduction in floodplain elevations
 - Relative to existing FEMA-published floodplain elevations
 - Flood reductions due to each proposed alternative

Given the depths of the 10%, 2%, and 1% storm floodplains in the project area (nearly 10 feet in some locations), the annual expected losses calculated by the BCA tool are relatively high. Given the potential for major losses due to automobile flooding in the low-lying parking lots, the overall economic benefit of floodplain reduction is significant.

Based on our use of the BCA tool, we calculated the following preliminary project benefits:

- Annual avoided damages after mitigation: \$400,416
- Present value of avoided damages: \$5.5 million (based on a 50-year life cycle)

The BCA tool has a flaw that overestimates losses for frequent storm events when the existing 10%, 2%, and 1% storm flood profiles are roughly equal, as it incorrectly extrapolates the high water surface elevations to frequent events, such as the 50% storm (2-year recurrence interval). To reconcile this, we manually eliminated any mitigation impact (i.e. benefit) for events less than the 10% storm (10-year recurrence interval). Although this has the impact of reducing the calculated economic benefit, it provides a more realistic approach that will likely stand up better to FEMA review, should the City pursue a Pre-Disaster Mitigation Grant.

Given that we did not have access to all available information, such as business income and rail income, we limited our analysis to residential property damage, automobile damage in low-lying parking lots, and business displacement costs as defined by the default equations in the BCA Tool. We expect that a more thorough analysis (as part of a FEMA Pre-Disaster Mitigation Grant application) would yield a more accurate economic benefit and would therefore have a slight impact on the BCRs for each project alternative.

As all project alternatives were developed to provide the same approximate hydraulic benefit, the mitigation benefits are the same for all alternatives. However, as the cost of each alternative varies, the Benefit-Cost Ratios (BCRs) are different for each project. The total project cost used to calculate the BCR is based on the initial capital investment (as summarized in Table 1) plus the discounted maintenance costs over the 50-year life cycle. For Alternatives 1 and 2, the annual maintenance was

assumed to be \$15,000. For Alternatives 3 and 4, the annual maintenance was assumed to be \$30,000.

Based on the economic benefit calculated by the BCA Tool, the following BCRs apply to the project alternatives:

- Alternative 1: BCR = 2.41
- Alternative 1a: BCR = 2.85
- Alternative 2: BCR = 2.07
- Alternative 2a: BCR = 2.54
- Alternative 3: BCR = 1.33
- Alternative 4: BCR = 1.06

All of the studied alternatives result in a BCR above 1.0. However, since Alternative 4 is closer to 1.0, it is possible that additional design and analysis may yield a different and potentially less favorable outcome for Alternative 4.

The project costs used to calculate the BCRs specifically excluded the Depot Street relief sewer component, which would likely *not* be considered an integral part of a grant-eligible flood control project.

A summary of the BCA tool output (economic benefit by parcel) is included in Appendix D.

Public Meetings

A public meeting was held on March 13, 2013 to discuss the project goals and seek feedback on. The key purposes of the public meetings were:

- Receive feedback on key local concerns with respect to flooding
- Discuss this project in the context of other downtown and Allen Creek planning objectives
- Review flood reduction alternatives and discuss impact on flooding severity
- Discuss the need for pedestrian access under the railroad and initial MDOT response on improvement scenarios
- Review the relative costs of alternatives

At the first public meeting, the OHM Advisors project team and City staff summarized the Allen Creek Berm project in the context of other City planning objectives in the general area and highlighted the key objectives of this project.

Key issues brought up by public attendees included:

- Pedestrian access under the railroad and future use of the DTE Gas site
- Potential for future creek daylighting
- Using tunneling to build pedestrian crossing (as opposed to open cut and track removal and a temporary shoofly)
- Need to establish a pedestrian link to North Main (through private property)

Comments received at the first public meeting were considered in the development of this document. Specific responses to public comment at the first public meeting include the following:

Tunneling techniques to construct pedestrian crossing: given the size of tunnel needed to accommodate pedestrians, conventional pipe tunneling techniques could not be employed at this location. Given the relatively short vertical clearance between the top of pedestrian tunnel and track elevation, there is no tunneling option that would be more cost-effective than the alternatives presented in this document.

Need to establish a pedestrian link to North Main: the figures illustrating the proposed improvements include an alternative pedestrian link to North Main. The cost and feasibility of this pedestrian access scenario should not vary much from the proposed access from the east side of the 201 Depot site (from the Depot/5th intersection). The North Main pedestrian connection alternative will require a pedestrian access easement.

An at-grade pedestrian crossing is not feasible: although there are other at-grade crossings of this rail line in Ann Arbor, it is very unlikely that MDOT would approve an additional at-grade crossing. Even if a new crossing were permitted, state law would require that an existing at-grade crossing be removed to balance the addition of a new at-grade crossing. This would disrupt access at another key location in Ann Arbor.

The second public meeting for this project was held on December 4, 2013. This meeting was intended to convey the recommended alternative and inform the public about the next steps towards eventual implementation. The responses received during the meeting were primarily related to questions about the preferred alternative and how it would impact future flood potential. In general, those in attendance supported the alternative presented at the meeting.

The summaries from the two public meetings are included in Appendix E.

Technical Advisory Committee (TAC) Meetings

Three TAC meetings were held during the project. Those in attendance included OHM Advisors, Bergmann Associates (railroad subconsultant), WCWRC representative, and selected City staff. The meeting dates and primary topics of discussion are summarized as follows:

TAC Meeting #1: December 19, 2012, 2:00 p.m.

- Appropriate modeling methodology for hydraulic analysis
- Status of FEMA Pre-Disaster Mitigation Grant funding and information needs for Benefit-Cost Analysis
- Appropriate timing for FEMA Letter of Map Revision application
- Update on the status of the railroad ownership transfer from Norfolk Southern (NS) to MDOT
- Likely issues to be encountered with MDOT and key rail users (NS and Amtrak)
- Status of first floor elevation survey
- Environmental concerns on the DTE Gas property and need to coordinate closely with DTE Gas representatives
- Public meeting content and key project goals

TAC Meeting #2: February 19, 2013, 2:00 p.m.

- Presentation of early hydraulic relief alternatives with impacts to floodplain footprint
- Discussion of differences between basic flood control and flood control with pedestrian access

- Presentation of potential rail modifications to accommodate construction
- Discussion of DTE Gas concerns and site constraints
- Discussion of materials to prepare for first public meeting

TAC Meeting #3: May 3, 2013, 9:30 a.m.

- Discussion of the draft Technical Memorandum
- Review of TAC member comments on the draft Technical Memorandum and discussion of final steps to complete project
- Discussion of assumptions used for the cost estimates and agreed to revisit some of the costs for Alternatives 3 and 4 to better match recent City experience with bridge construction costs

TAC meeting summaries and attendee lists are included in Appendix F.

Project Alternatives

The two primary objectives of this project are as follows:

- Reduce the floodplain elevation upstream (south) of the railroad as much as practical and reduce the potential for private property damage due to flooding.
- Provide the means to connect pedestrians to the DTE Gas property, a portion of which may be returned to public use and may serve as a key downtown destination.

In order to address the first objective (flood reduction), it was necessary to determine the overland flow patterns and select a location (or locations) where flood waters could most efficiently be conveyed under the railroad and to the Huron River. Based on our review of area topography and the EPA SWMM model results, we determined that the flood waters were concentrated in the 201 Depot property. A hydraulic relief along the railroad at 201 Depot would provide the best option of maximizing the flow potential of a flood relief structure (culvert or bridge). This location would also minimize the distance from the railroad to the Huron River, thereby minimizing the potential for encountering contaminated soils on the DTE Gas site.

After additional study and consultation with the TAC, it was determined that the west half of this study area would be the most ideal for hydraulic improvements, largely due to the following criteria:

- The flood waters naturally collect west of the 201 Depot office building.
- This area is lower than all adjacent areas.
- The flood route to the Huron River is shortened, thereby minimizing disruption to the DTE Gas property.

All alternatives reduce the 1% storm floodplain to (or about) 773.0 (a reduction of 6.5 feet relative to existing conditions). The alternatives considered as part of this study are described below. Planning-level cost estimates are detailed in Appendix G.

Cost estimates for all described alternatives are listed in Table 1. Additional detail for the estimates is included in Appendix G.

Alternative 1: 54-inch RCP Culverts with Drop Structure (No Pedestrian Access)

This alternative includes five (5) 54-inch diameter RCP culverts (~85 feet long) bored and jacked under the railroad, straddling the existing 48-inch diameter relief sewer at the northwest corner of the 201 Depot property (see Figure 4). This location is consistent with the area confirmed by Mike Martin (local property owner) as the area receiving the most direct hit from floodwaters.

The invert elevations of the proposed culverts should be approximately equal to the existing 48-inch culvert. This allows the installation of a “drop inlet” structure which allows additional hydraulic pressure (headwater) on the culverts and minimizes the culvert size. Although fewer (and larger) culverts may seem ideal in this situation, the 54-inch culverts were chosen to satisfy the following constraints:

- As these culverts will likely be bored and jacked, it is necessary to maximize the cover above the pipe and avoid unnecessary loading from the railroad bed.
- Trenchless installation of 54-inch culverts provides more options for installation. Installation costs go up sharply for pipe sizes larger than 54-inch diameter.
- Minimizing the culvert size reduces the chances of encountering a physical conflict with the fiber optic conduit on the north side of the railroad tracks (the depth of the fiber optic conduit has not been verified).
- Larger pipes encourage pedestrians to use them for crossing the railroad. 54-inch and smaller pipes discourage pedestrian access (although the ends of the 54-inch pipes will likely require some additional protective grating to further discourage access).

The upstream end of the culvert will be surrounded by a concrete chamber that provides the vertical transition from 770.0 to 764.0. The bottom of the chamber should be sloped so as to avoid any standing water and making cleanout/maintenance easier. The top of the concrete chamber will act as a weir. A grating/cover should be installed over the top of the chamber to discourage anyone from entering the chamber, which will be six feet deep. The grating could consist of aluminum or fiberglass/FRP inserts that would cover the entire footprint of the chamber (see example photos) while providing an adequate vertical



opening at the weir to accommodate maximum inflow. Balancing pedestrian safety and hydraulic efficiency will be a critical consideration during the design process.

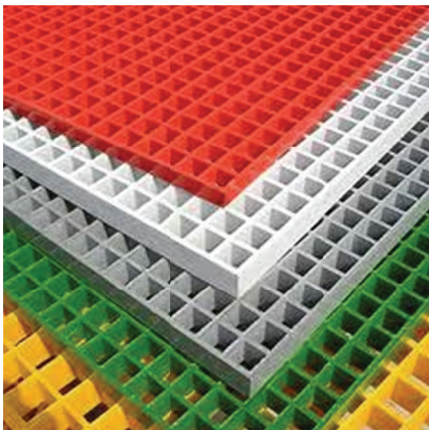

The expanded culvert structure (five 54-inch pipes and the existing 48-inch pipe) will outlet to a transition chamber north of the railroad right-of-way where the flows will be constricted to twin 4' x 8' box culverts. The box culverts will convey the flow through the DTE Gas property to the Huron River. High velocities in the enclosed system can be dissipated by installing a baffle structure at the downstream end of the twin box culverts or lowering the outlet elevation below the

normal water level of the Huron River. The latter will discourage people from attempting to enter the culvert from the downstream end.

201 Depot – Parking Lot Flood Relief

For this and all subsequent alternatives, additional measures are proposed in order to isolate the Depot Street 36-inch storm sewer from the Allen Creek enclosure. This helps to eliminate reverse flow that has been observed near the Depot/4th intersection and enhances the operational efficiency of the local storm sewers that impact the 201 Depot parking lot. Although this improvement is not necessary for 1% storm flood control, it provides a significant benefit to the area for a relatively small marginal cost.

The figures and cost estimates for Alternatives 1-4 include a 48-inch storm sewer from Depot Street north through the 201 Depot property. This sewer, referred to as the *Depot Street Relief Sewer*, will outlet to various locations (depending on the specific alternative). This relief sewer will allow the City to abandon (plug) the connection between the 36-inch Depot Street storm sewer and Allen Creek.

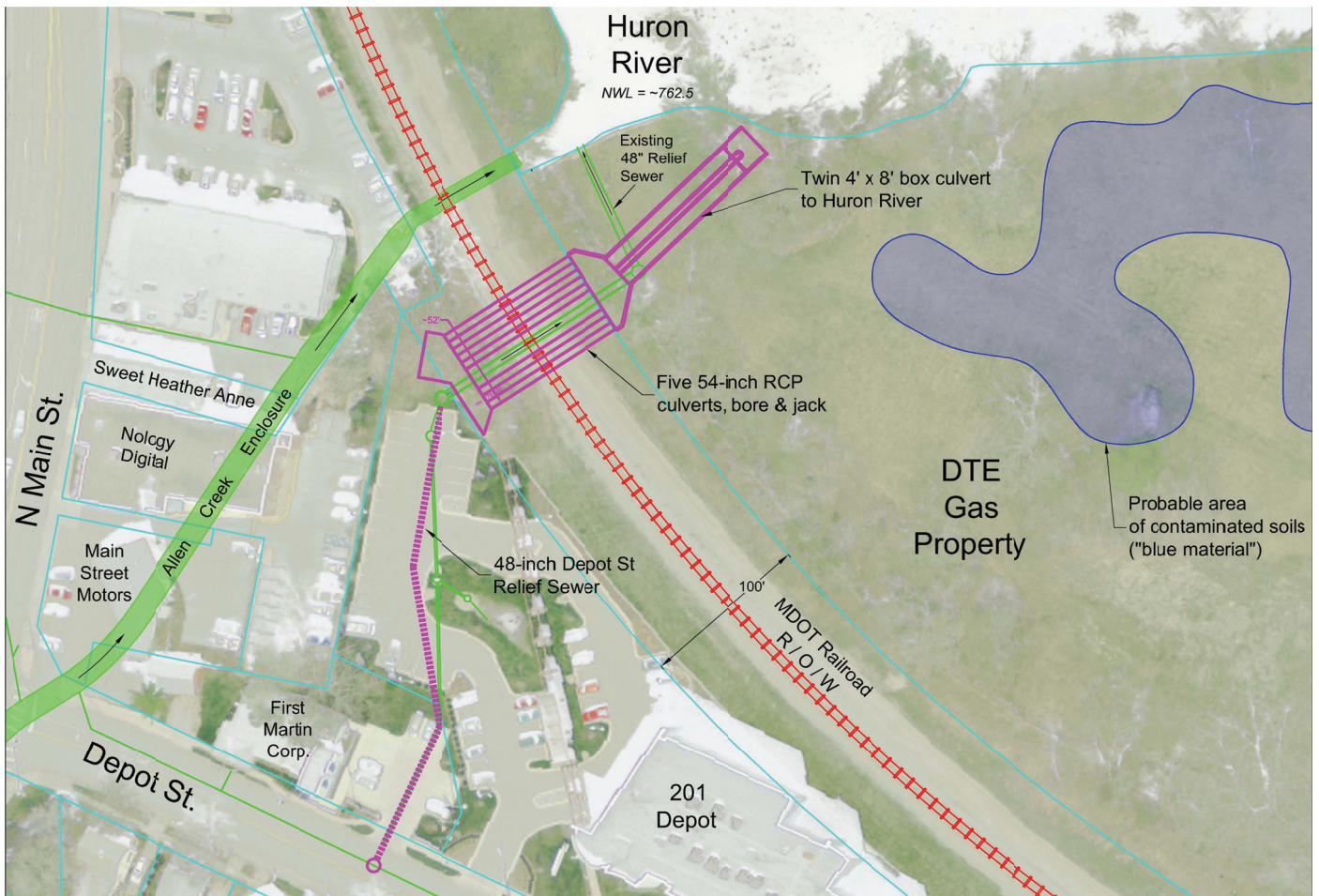

Figure 4
Alternative 1

Alternative 1a: 54-inch RCP Culverts (No Pedestrian Access) – OPEN CHANNEL

Alternate 1a is identical to Alternate 1, except for a change from enclosed to open channel drainage from the railroad to the Huron River (see Figure 5).

The outlet for Alternative 1 can consist of an open channel or enclosed system. The key differences between the two outlet options are listed in Table 3. Although an open channel option is not consistent with the goals of DTE Gas (the owner of the property on which the hydraulic outlet will be located), there is a potential to reduce project costs and enhance stormwater quality with an open channel. With the proposed Depot Street Relief Sewer, stormwater runoff would enter this proposed open channel during frequent (“dirty”) storm events. Natural vegetation in the channel would allow the flow to spread to a wide cross section and be filtered prior to discharge to the Huron River. The water quality impact would be most pronounced for smaller storm events, primarily less than 1 inch of rainfall.

**Table 3
Huron River Outlet – Open vs. Closed Channel**

Outlet Option	Description	Advantages	Disadvantages
Open Channel	30-foot bottom, 8:1 sideslopes with naturalized surface (wetland/meadow). Requires compacted clay layer to isolate contaminated soils beneath.	More cost-efficient than a closed channel. Natural vegetation and gentle slopes prevent high flow velocities and allow for a pedestrian crossing (via a raised boardwalk, similar to a wetland boardwalk). This option also provides a water quality benefit by providing filtration prior to discharge to the Huron River.	Requires a larger area for grading and increases chances of encountering contaminated soils. May interfere with DTE Gas site development plans.
Closed (Piped) Channel	Twin 4' x 8' box culvert	Allows for more flexibility for site planning purposes, and is consistent with the preferences of DTE Gas.	Significantly more expensive than the open channel option. Requires additional concrete chamber on downstream end of culverts. Flow velocities are much higher than open channel option.

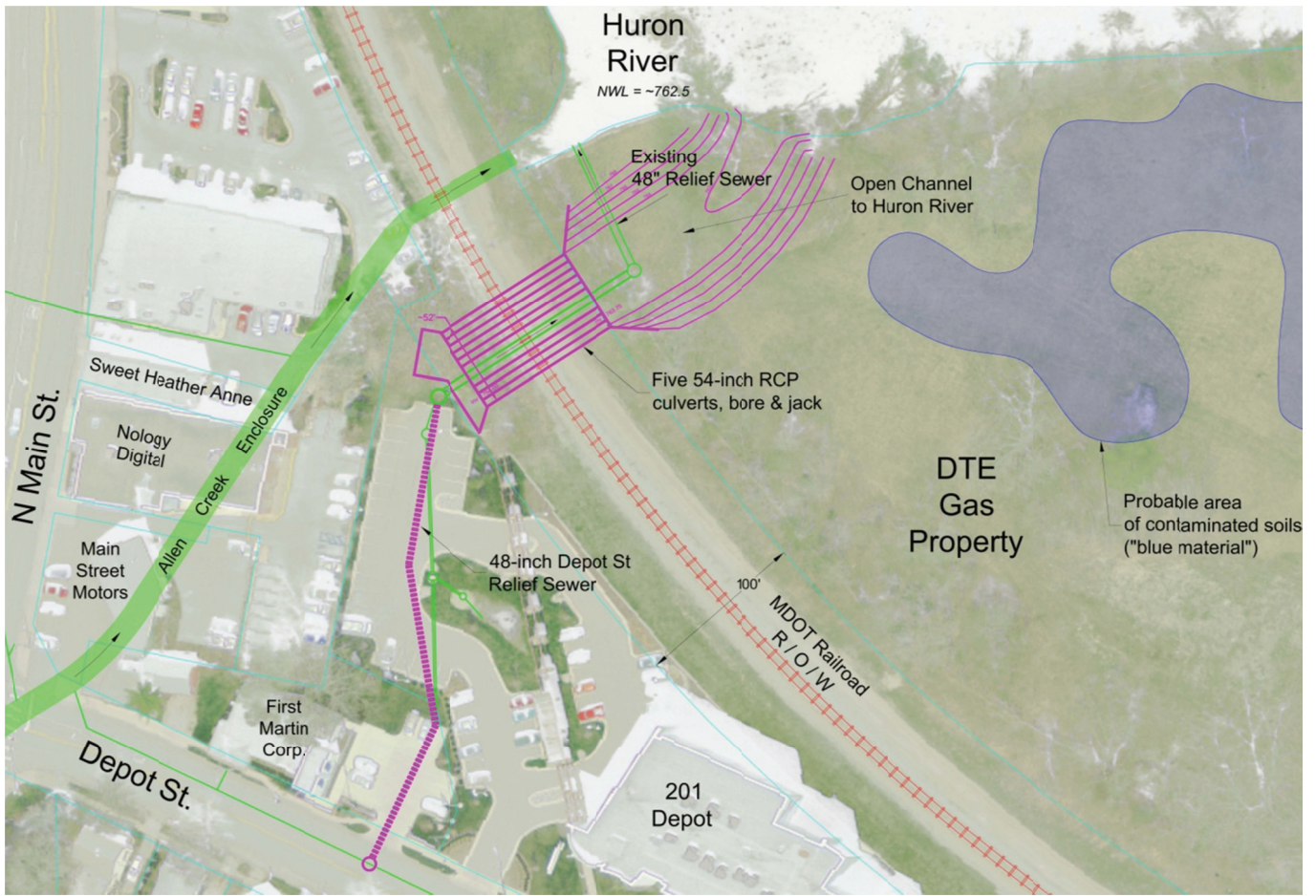

Figure 5
Alternative 1a

Alternative 2: At-Grade 48-inch RCP Culverts (No Pedestrian Access)

This alternative includes seven (7) 48-inch diameter RCP culverts (~90 feet long) bored and jacked under the railroad at the 201 Depot property (see Figure 6). This location is south of the locations proposed under Alternatives 1/1a.

The invert elevations of the proposed culverts under this alternative would be at existing grade on the south side of the railroad. This allows the stormwater to enter the culverts without the aid of a concrete drop structure as proposed in Alternatives 1/1a. The drawback to this alternative is that there is less headwater to push flows through the culverts and more pipes are necessary to accomplish the same hydraulic benefit. The MDOT Office of Rail may require bar grating on the end sections to prevent anyone from entering the pipes.

The downstream end of the seven 48-inch culverts would be set approximately 6 feet below the upstream end. This increases the likelihood that the culverts can be constructed well below the existing fiber optic conduit that is known to exist along the north side of the railroad right-of-way (the depth of the fiber optic conduit has not yet been verified).

As with Alternatives 1/1a, the culverts can be bored and jacked.

The culvert structure (seven 48-inch pipes) will be fairly wide and will require a transition chamber north of the railroad right-of-way where the flows will be constricted to twin 4' x 8' box culverts. The box culverts will convey the flow through the DTE Gas property to the Huron River. High velocities in the enclosed system can be dissipated by installing a baffle structure at the downstream end of the twin box culverts or lowering the outlet elevation below the normal water level of the Huron River. The latter will discourage people from attempting to enter the culvert from the downstream end.

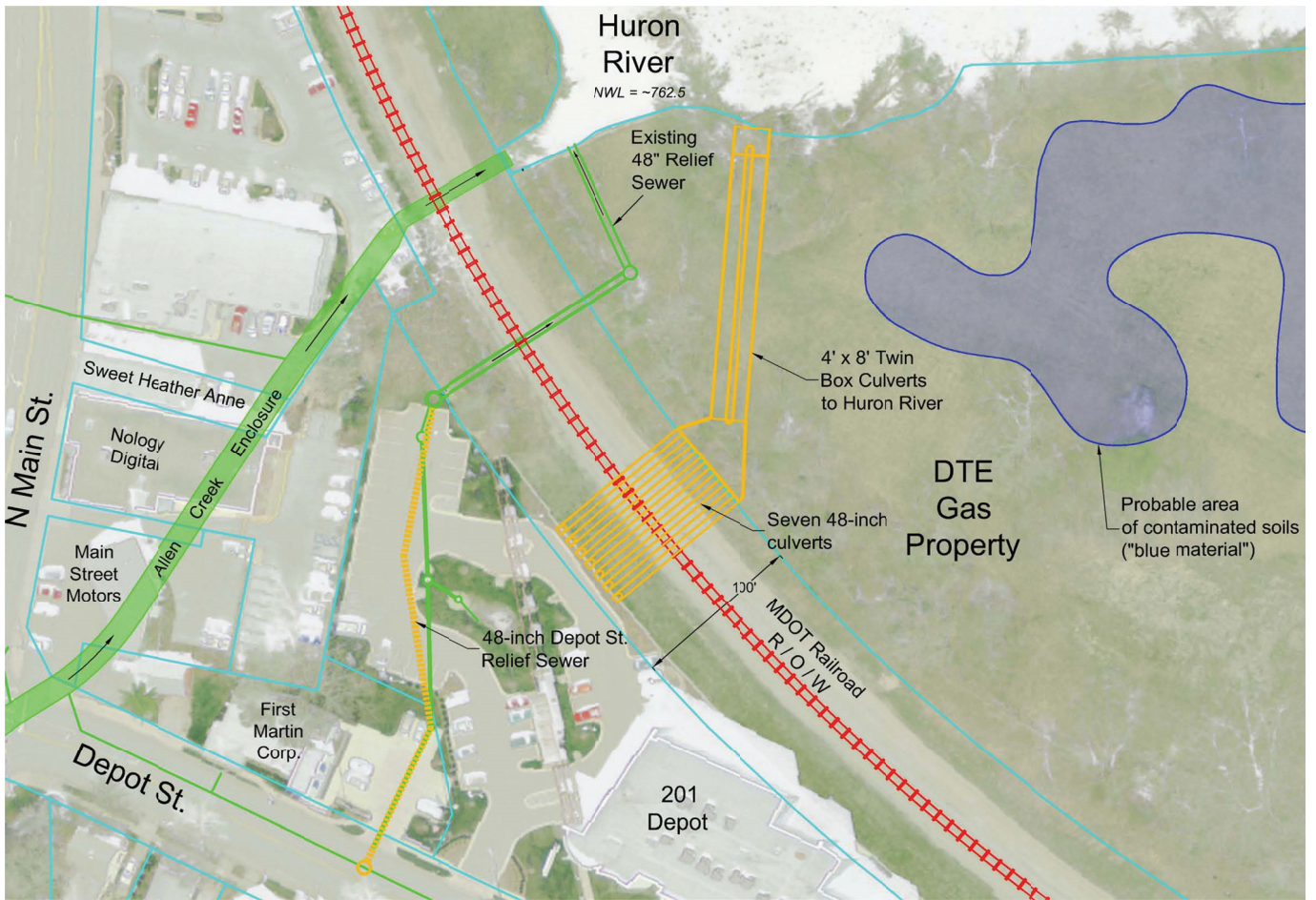

Figure 6
Alternative 2

Alternative 2a: At-Grade 48-inch RCP Culverts (No Pedestrian Access) – OPEN CHANNEL

Alternate 2a is identical to Alternate 2, except for a change from enclosed to open channel drainage from the railroad to the Huron River (see Figure 7). The key differences between the two outlet options are listed in Table 3.

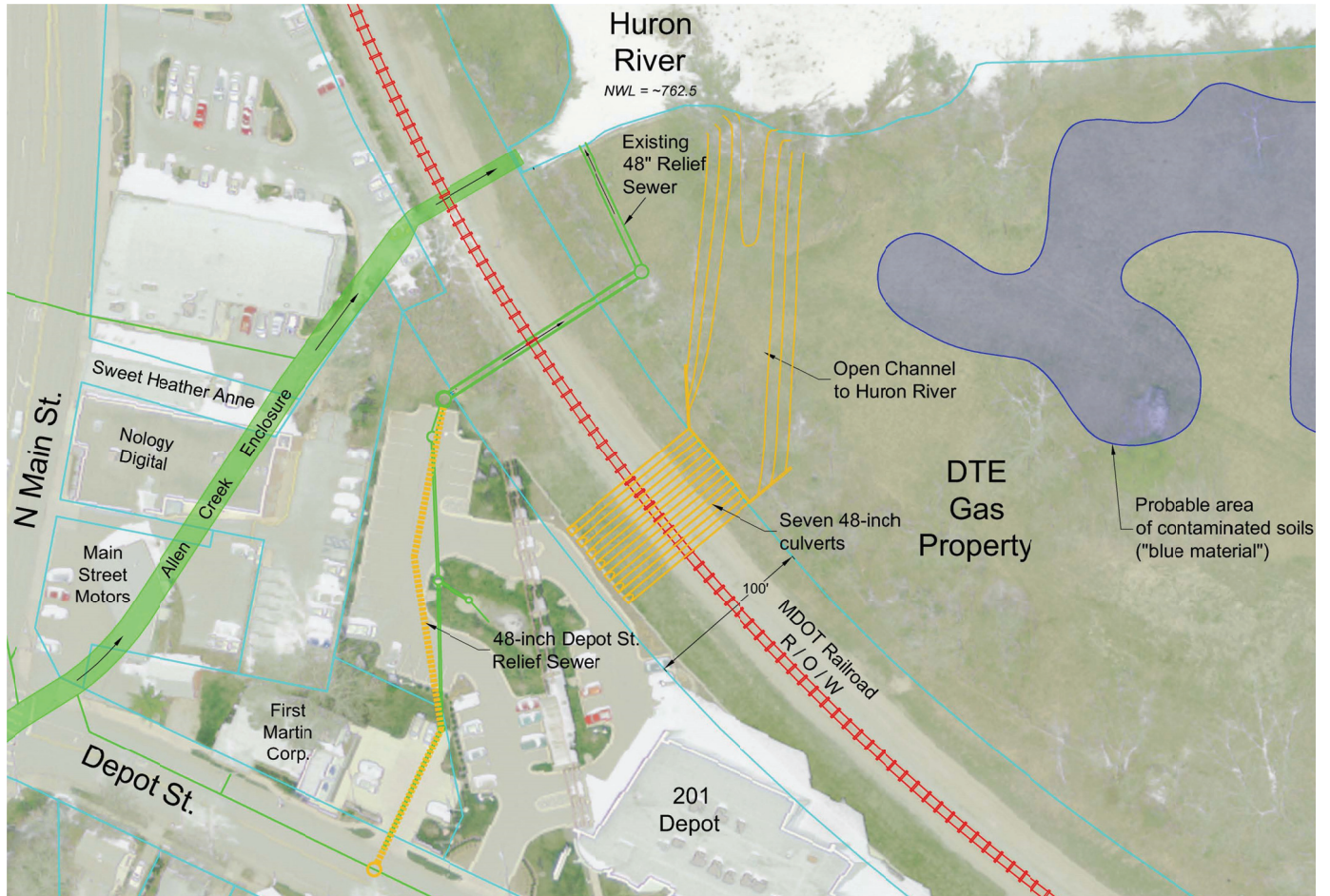

Figure 7
Alternative 2a

Alternative 3: Flood Control Culvert with Pedestrian Access

This alternative accommodates a pedestrian crossing under the railroad while preserving the hydraulic benefits of Alternatives 1 and 2 (see Figure 8).

Although trenchless construction options (i.e. boring and jacking) may be feasible for Alternatives 1 and 2, there are no known cost-efficient trenchless methods to install a pipe/culvert large enough to accommodate pedestrians. Open cut methods will also require the temporary relocation of the rail, as the rail users would not likely permit any service disruption along this rail line.

Under this alternative, two separate culverts (each 60 feet long) would be constructed. A lower culvert (20' span x 6' rise) would be used to convey floodwaters to the north side of the railroad tracks, and a higher culvert (14' span x 8' rise) would be used to accommodate pedestrians. Both culverts would be 3-sided concrete pre-cast sections set on pile-supported footings (see Figure 8a). The upstream end of the culverts would be similar to that of Alternative 1, as it would be necessary to construct a concrete drop structure to allow floodwaters to flow into the lower culvert from the adjacent parking lot.

A short (~4-foot) floodwall would need to be constructed to isolate the pedestrian culvert from the 1% storm flood depths in the parking lot at 201 Depot. This will allow the pedestrian culvert to be isolated from the floodwaters that will favor the lower culvert. The downstream side of the pedestrian culvert will require additional walls to isolate the pedestrian underpass from the Huron River 1% storm floodplain.

The upstream end of the lower (flood conveyance) culvert will be surrounded by a concrete chamber that provides the vertical transition from elevation 770.0 to 763.5. The top of the concrete chamber will act as a weir (similar to Alternate 1). A grating/cover should be installed over the top of the chamber to discourage anyone from entering the chamber, which will be over six feet deep. The bottom of the chamber should be sloped so as to avoid any standing water and making cleanout/maintenance easier.

Under this alternative, the proposed pedestrian pathway would commence at the 5th/Depot intersection, head north to the MDOT railroad right-of-way, and then along the south edge of the railroad right-of-way towards the proposed culvert. The sidewalk should be ramped at 5% and would require retaining walls from the 201 Depot office building to the culvert. North of the railroad, the pathway will ramp back to existing grade and be integrated with the future improved site on the DTE Gas property.

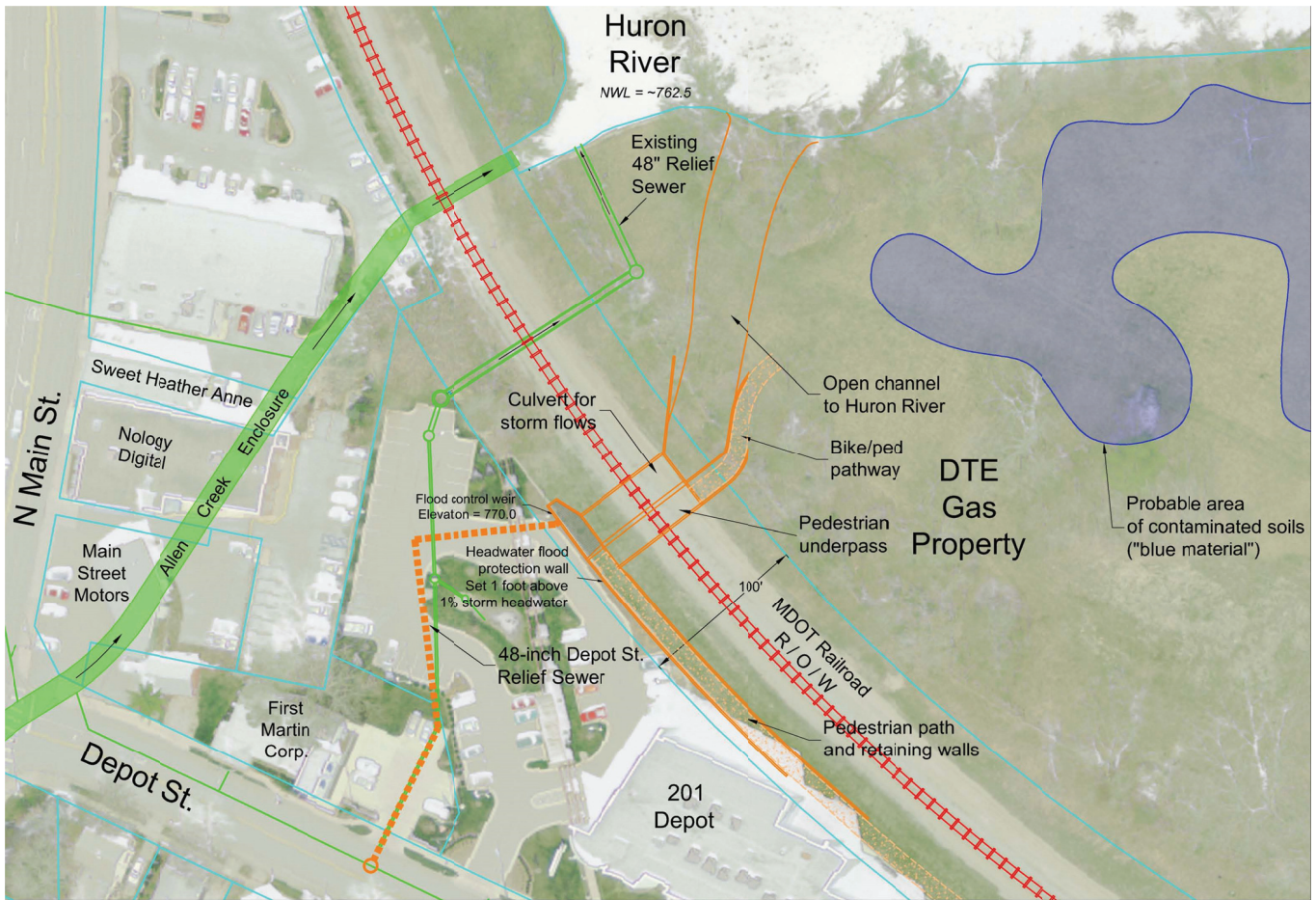

Figure 8
Alternative 3 – Pedestrian Culvert

The proposed hydraulic outlet for this alternative is an open channel, similar to Alternatives 1a and 2a.

The construction of this alternative will require a shoofly (temporary railroad) to accommodate continuous rail traffic during construction. Given the geometric requirements of the track relocation, the shoofly will require the installation of approximately 1,800 feet of temporary track, including a temporary bridge over the existing Allen Creek outlet to accommodate the temporary track.

A fiber optic line exists on the north side of the railroad right-of-way. Construction of Alternative 3 will likely require the relocation of the fiber optic, which is typically a significant cost item.

All anticipated design and construction costs are included in the planning-level cost estimate.

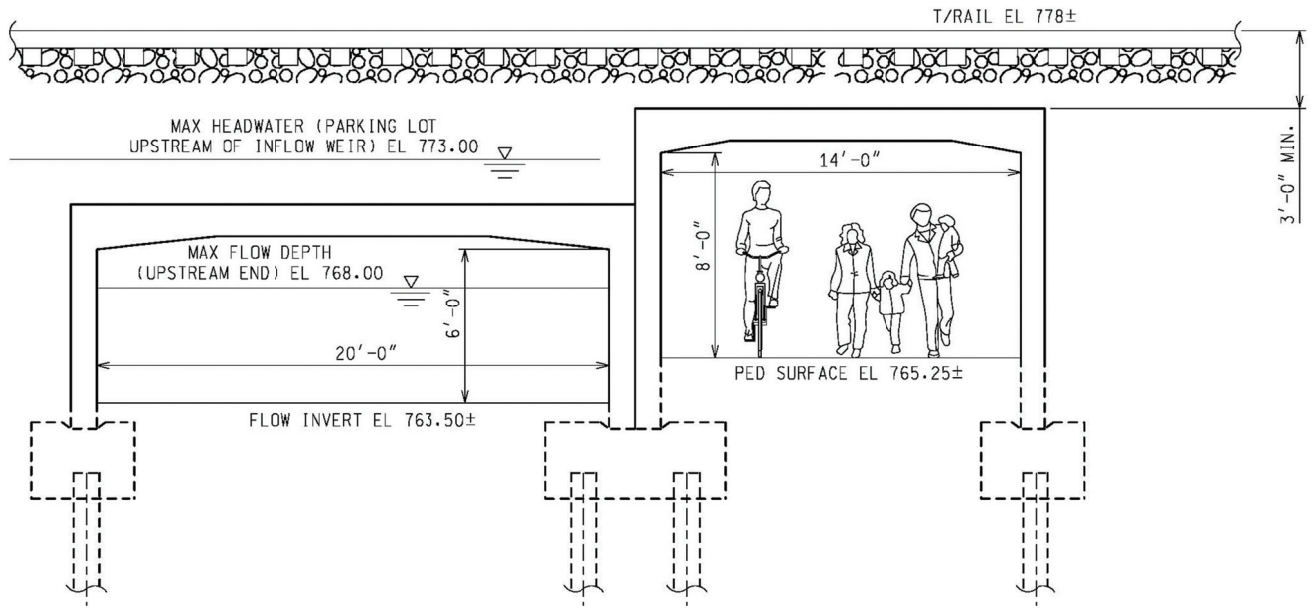

Figure 8a
Alternative 3 – Pedestrian Culvert (Cross Section)

Alternative 4: Trestle Bridge Option – Flood Control with Pedestrian Access

This alternative is similar to Alternative 3, although it replaces pre-cast culverts with a 60-foot long trestle bridge. This alternative accommodates a pedestrian crossing under the railroad while preserving the hydraulic benefits of Alternatives 1, 2, and 3 (see Figure 9).

Under this alternative, a two-span bridge would be constructed. *A single-span bridge was considered, although the increased span length necessary to accommodate pedestrians and flood conveyance would increase the depth of structural steel necessary for the bridge beams and would therefore reduce the vertical clearance for pedestrians below the recommended 8-foot minimum.* The main span would be separated by a flood wall to isolate the pedestrian-access side of the bridge from the flood conveyance side (see Figure 9a). The upstream end of the bridge would be similar to that of Alternative 3, as it would be necessary to construct a concrete drop structure to allow floodwaters to flow into the bridge opening from the adjacent parking lot and to provide a flood wall to protect the pedestrian component from floodwaters.

As with Alternative 3, a short (~4-foot) floodwall would need to be constructed to isolate the pedestrian side of the bridge from the 1% storm flood depths in the parking lot at 201 Depot. This will allow the pedestrians to be isolated from the floodwaters that will favor the north side of the bridge. The downstream side of the bridge will require additional walls to isolate the pedestrian underpass from the Huron River 1% storm floodplain.

The upstream end of the bridge will include a concrete chamber that provides the vertical transition from elevation 770.0 to 763.5. The top of the concrete chamber will act as a weir (similar to Alternates 1 and 3). A grating/cover should be installed over the top of the chamber to discourage anyone from entering the chamber, which will be over six feet deep. The bottom of the chamber should be sloped so as to avoid any standing water and making cleanout/maintenance easier.

Under this alternative, the proposed pedestrian pathway would commence at the 5th/Depot intersection, head north to the MDOT railroad right-of-way, and then along the south edge of the railroad right-of-way towards the proposed culvert. The sidewalk should be ramped at 5% and would require retaining walls from the 201 Depot office building to the bridge. North of the railroad, the pathway will ramp back to existing grade and be integrated with the future improved site on the DTE Gas property. *The following section includes a description of an alternate pedestrian access point from North Main.*

The proposed hydraulic outlet for this alternative is an open channel, similar to Alternatives 1a, 2a, and 3.

The construction of this alternative will require a shoofly (temporary railroad) to accommodate continuous rail traffic during construction. Given the geometric requirements of the track relocation, the shoofly will require the installation of approximately 1,800 feet of temporary track, including a temporary bridge over the existing Allen Creek outlet to accommodate the temporary track.

A fiber optic line exists on the north side of the railroad right-of-way. Construction of Alternative 4 will likely require the relocation of the fiber optic, which is typically a significant cost item.

All anticipated design and construction costs are included in the planning-level cost estimate.

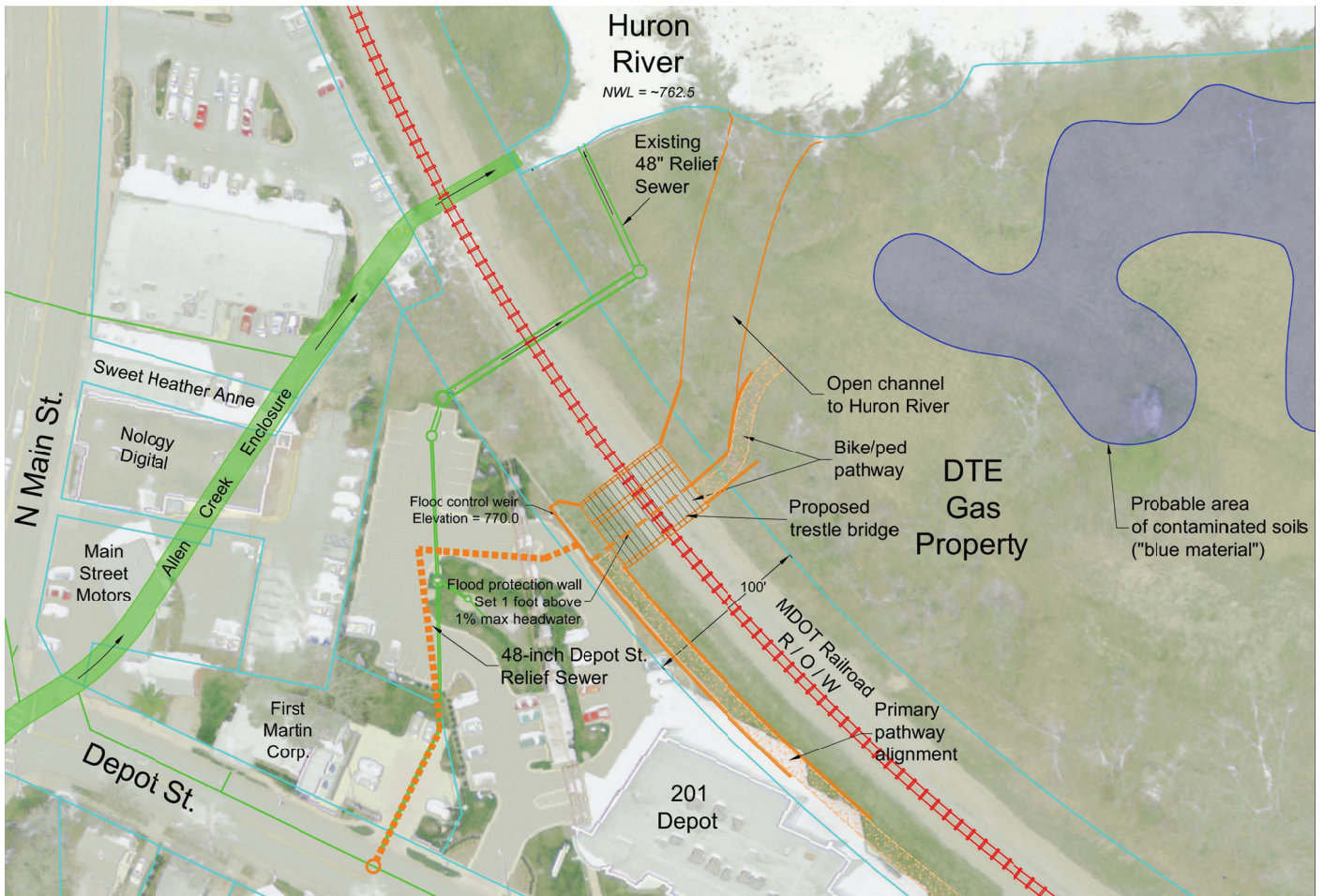

Figure 9
Alternative 4 – Trestle Bridge

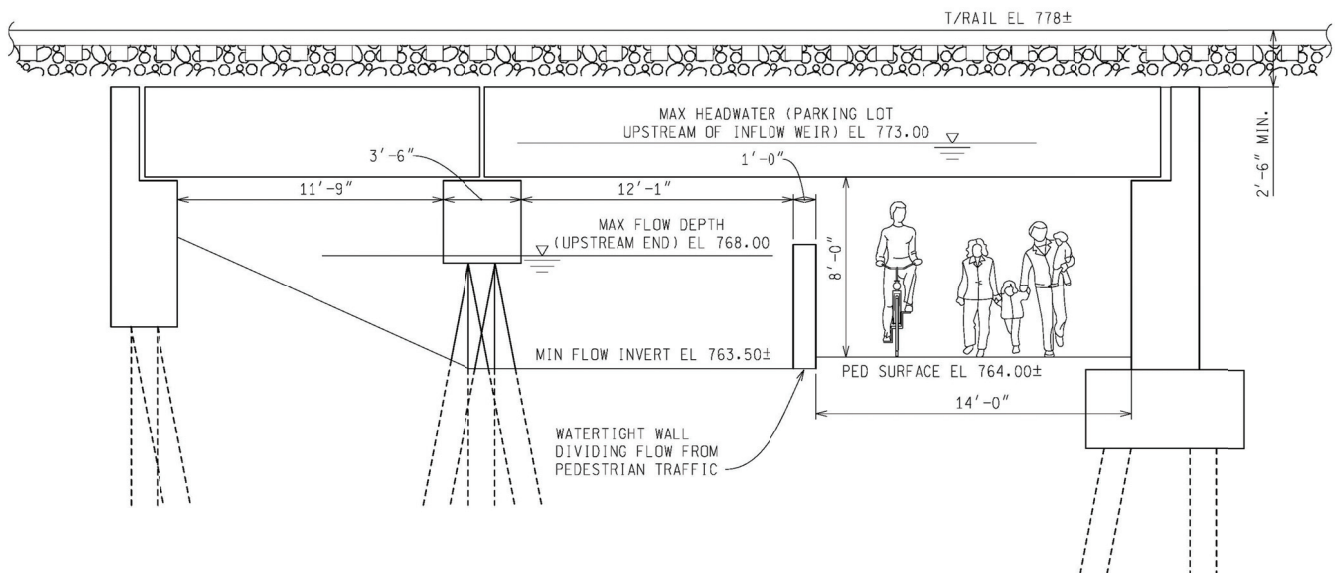

Figure 9a
Alternative 4 – Trestle Bridge (Cross Section)

Pedestrian Access Alternative: North Main Street

At the first public meeting, several attendees mentioned the possibility of reviewing an alternate connection point for the proposed pedestrian/bicycle pathway. As an option to constructing the pathway along the north side of the 201 Depot office building (as depicted in Figures 8 and 9), the pathway could instead connect to North Main Street across the north edge of the 201 Depot parking lot and between existing buildings along North Main. This alternative will require a pedestrian access easement from Peter Allen, the owner of the properties where the access point is most practical. Figure 10 illustrates the potential alternate pedestrian connection options.

These options were discussed with Peter Allen, and Mr. Allen was generally supportive of a pedestrian connection through his property, provided that parking and vehicular access is not negatively impacted.

With the North Main connection, the pathway would need to drop approximately 13 vertical feet over a relatively short distance. This will require a combination of 8 percent slopes (with handrails to satisfy ADA requirements) and safety landings in order to drop low enough to get under the railroad at the proposed location. Additional expense would be required for this alternative to accomplish the following:

- Installation of retaining walls up to a height of 10 feet where the pathway reaches the railroad right-of-way from the 201 Depot property.
- Removal of old (abandoned) railroad piers and overhead steel supports to accommodate the pathway and associated retaining walls.
- Acquire easements on private property impacted by the proposed pedestrian pathway alignments. No commitments have yet been made with respect to potential pedestrian easements.

The Depot Street connection option would require less vertical drop, although significant upgrades would be required within Mr. Allen's parking areas in order to reconfigure parking so as to better accommodate pedestrians. Furthermore, additional protection would be required to prevent floodwaters from the 201 Depot parking lot from entering the pathway. It may also be necessary for the City to reimburse Mr. Allen for any lost parking spaces that may result from a reconfiguration. Mr. Allen suggested that the economic value of a single parking space is approximately \$25,000 (reflecting perpetual revenues from parking, based on current market rates).

Planning-level estimates in this document assume the pathway will be as depicted in Alternatives 3 and 4.

If either of the pathway alignments depicted in Figure 10 is selected, the bridge/culvert layouts would be modified to switch the pedestrian and flood flow components to the appropriate sides.

Although pedestrian access from both directions (east and west) would be desirable, it would not be physically possible to allow access from both sides while isolating floodwaters from the pedestrian passageways leading towards the upstream end of the bridge/culvert.

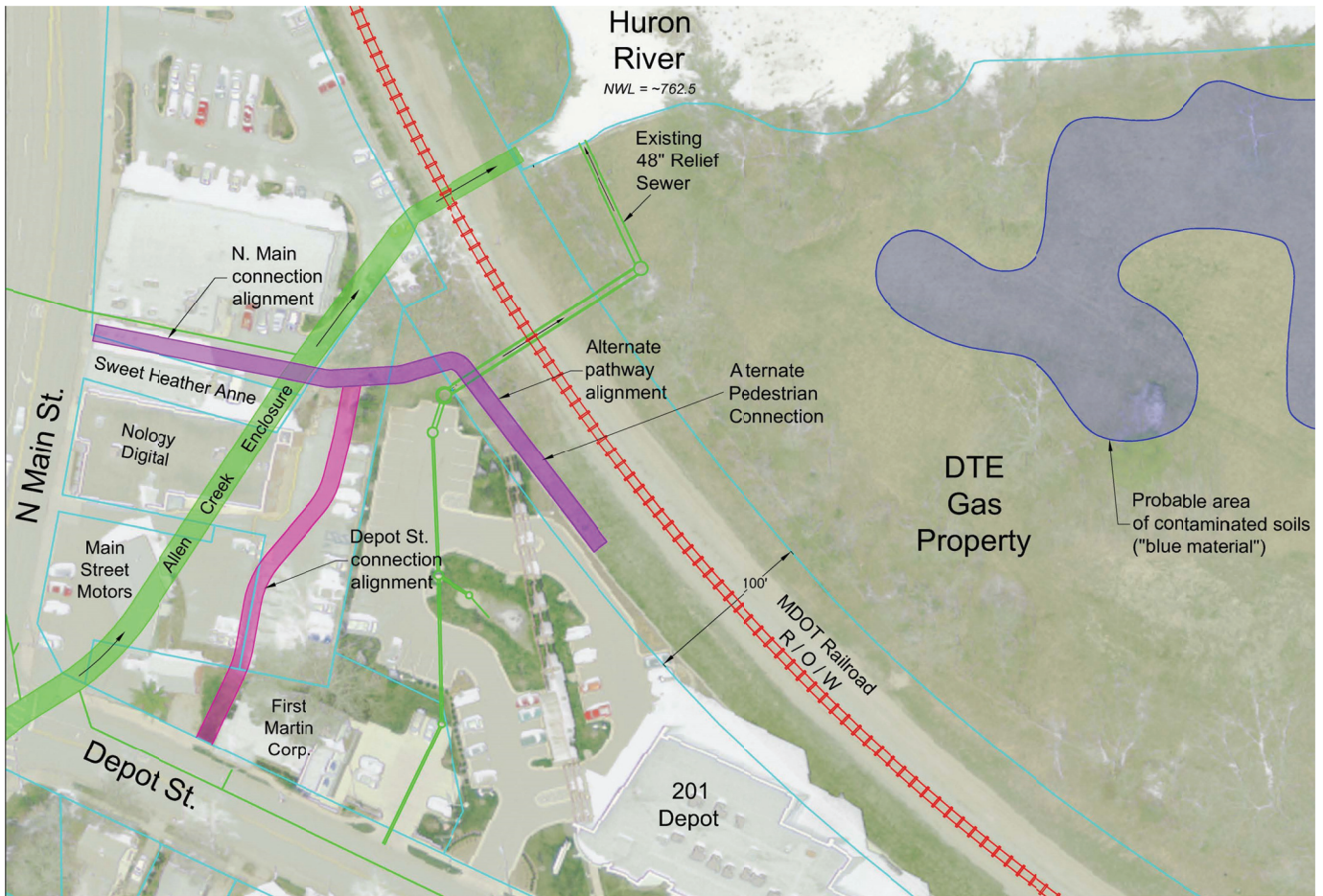

Figure 10
North Main Pedestrian Access Alternative

InfoSWMM Model Calibration – Impact on Sizing/Cost of Alternatives

The improvement alternatives and related cost estimates described in this document reflect the peak flow rates published in the latest FEMA Flood Insurance Study. Upon the completion of the InfoSWMM model calibration (expected around the end of 2013 or early 2014), it is likely that the calculated peak flows for Allen Creek will change significantly. Furthermore, updated rainfall statistics (NOAA Atlas 14) are now available and can be used to analyze runoff potential under more current and relevant rainfall depths (the 100-year 24-hour rainfall depth has gone up significantly since the previous modeling and floodplain mapping efforts).

The design of the selected alternative will rely heavily on the calibrated InfoSWMM model. The final sizing of flood control and pedestrian access components should be based on updated flow rates, as there is a significant potential to reduce project costs if the updated peak flow rates go down (as is expected).

Impact of Project Alternatives on the Flood Profile

As previously stated, all alternatives summarized in this document will reduce the 1% storm flood profile to approximately elevation 773 upstream of the railroad berm. Although the 6-foot reduction in the floodplain depth does not eliminate the flood footprint in the project area, it has a significant positive impact on the depth of flooding across the 201 Depot parking lot and the homes between Depot Street and Summit Street. Figures 11 and 12 illustrate the extents of the floodplain for existing and proposed conditions. Figure 13 includes a graphical depiction of the relative flood depths between the official (FEMA) and proposed conditions.



Figure 11
Existing Floodplain (Official FEMA Floodplain Elevation)



Figure 12
Floodplain After Proposed Improvements

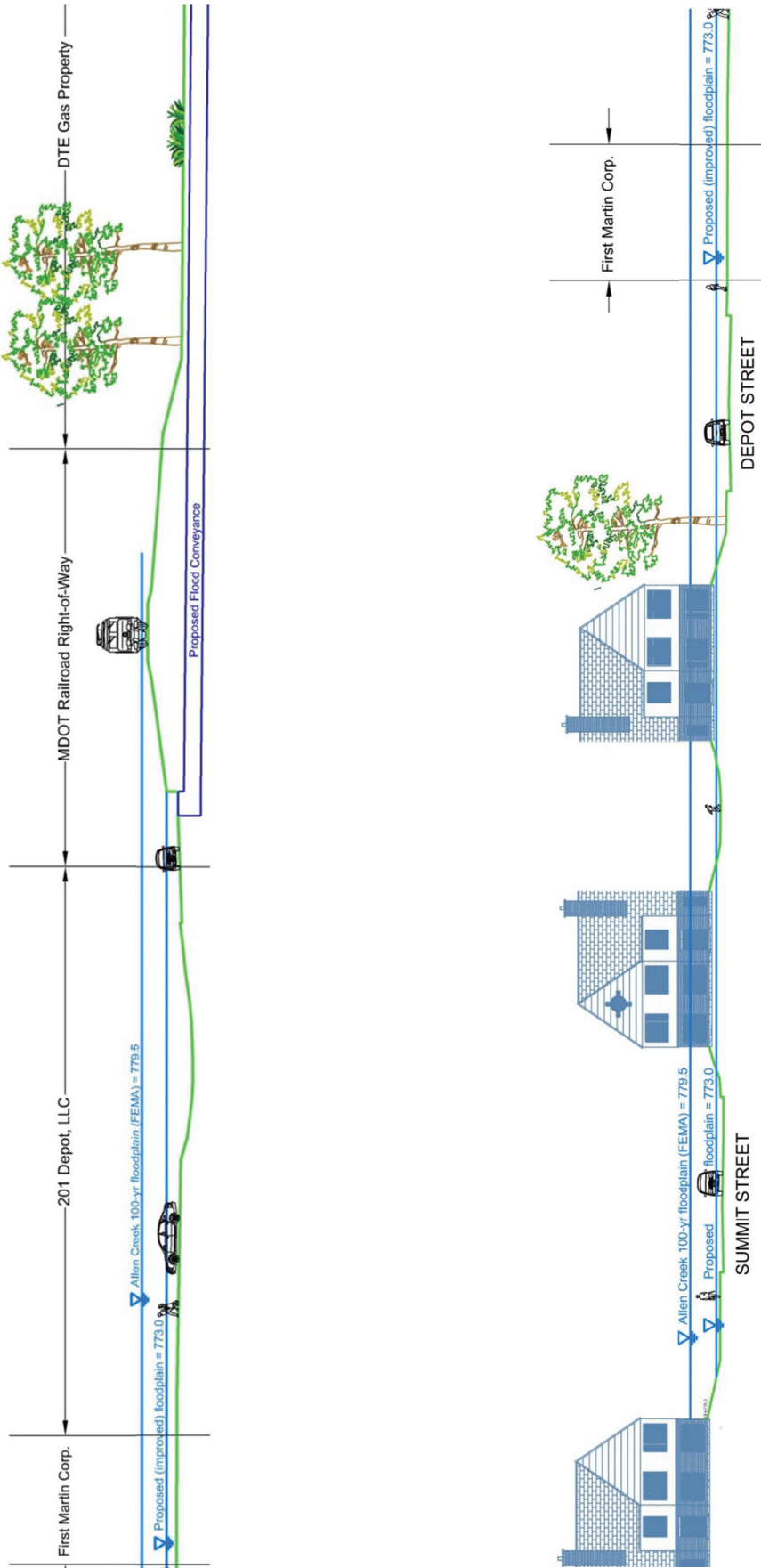

Figure 13
Flood Depths – Existing Official Floodplain vs. Proposed Conditions

Preferred Alternative

The Preferred Alternative is based on Alternative 3, with minor changes to reflect specific concerns conveyed to City staff by the MDOT Office of Rail. This alternative was selected for the following reasons:

- Alternative 3 addresses the need to provide pedestrian access under the railroad to the DTE Gas property (only Alternatives 3 and 4 addressed this need).
- Alternative 3 is less expensive than Alternative 4.
- Alternative 3 (with modifications discussed below) has received positive feedback from the MDOT Office of Rail.

Figure 14 illustrates the *Preferred Alternative*. The physical location of the culverts is the same as shown in Alternative 3, although the sidewalk configuration has been changed to address MDOT concerns about minimizing the length of sidewalk within the railroad right-of-way. This results in the need for property/easement acquisition to establish a pedestrian link to Main Street or near the Main/Depot intersection.

The proposed culvert/viaduct location cannot be moved further north, as doing so would shorten the sidewalk and make it difficult to accommodate ADA-required slopes without installing switchbacks. Furthermore, it would complicate the shoo-fly construction and potentially create a conflict between the shoo-fly alignment and the structural supports for the Ann Arbor Railroad bridge near the dam.

As the pedestrian/bicycle pathway needs to be protected against inundation during extreme flow events, a flood protection wall should be constructed along the pathway and should be set to one foot above the 1% storm headwater. Due to the topography in the project area, it would be more ideal to construct the pathway to N. Main (N. Main connection alignment as shown in Figure 14). Under this scenario, it would be less expensive to protect the pathway against flooding, as the west portion of the pathway would be elevated above the floodplain elevation. The Depot Street connection alignment is problematic, as the existing grades in this area are lower and would require flood protection walls along the entire alignment. This would probably create a conflict with desired parking and vehicle access needs.

Pedestrian access across the First Martin property is not shown, as it is yet unclear how the alignment of the pedestrian path will be finalized. This will depend on design-phase negotiations with the impacted property owners. The proposed cross section for the *Preferred Alternative* is depicted in Figure 15, which is essentially a mirror image of the Alternative 3 cross section.

Figure 16 illustrates the potential shoo-fly alignments necessary to accommodate the Preferred Alternative. The varied alignments are based on differing design speeds and will be subject to final MDOT approval. As stated in the description of Alternatives 3 and 4, the shoo-fly would likely require the construction of a temporary bridge near the Allen Creek outlet. This bridge could be constructed so as to accommodate a future pedestrian crossing over the Allen Creek outlet, immediately outside the railroad right-of-way. The cost estimate includes the consideration for the temporary bridge, but does not include any future retrofits necessary to accommodate pedestrians over the Allen Creek outlet.

The *Preferred Alternative* cost estimate is included in Appendix G. The estimate is similar to that of Alternative 3, with additional cost items related to potential property acquisition costs (buyout of parking spaces to accommodate pedestrian/bicycle pathway), additional costs to remove the piers for the old (abandoned) railroad and additional right-of-way fencing to meet MDOT feedback.

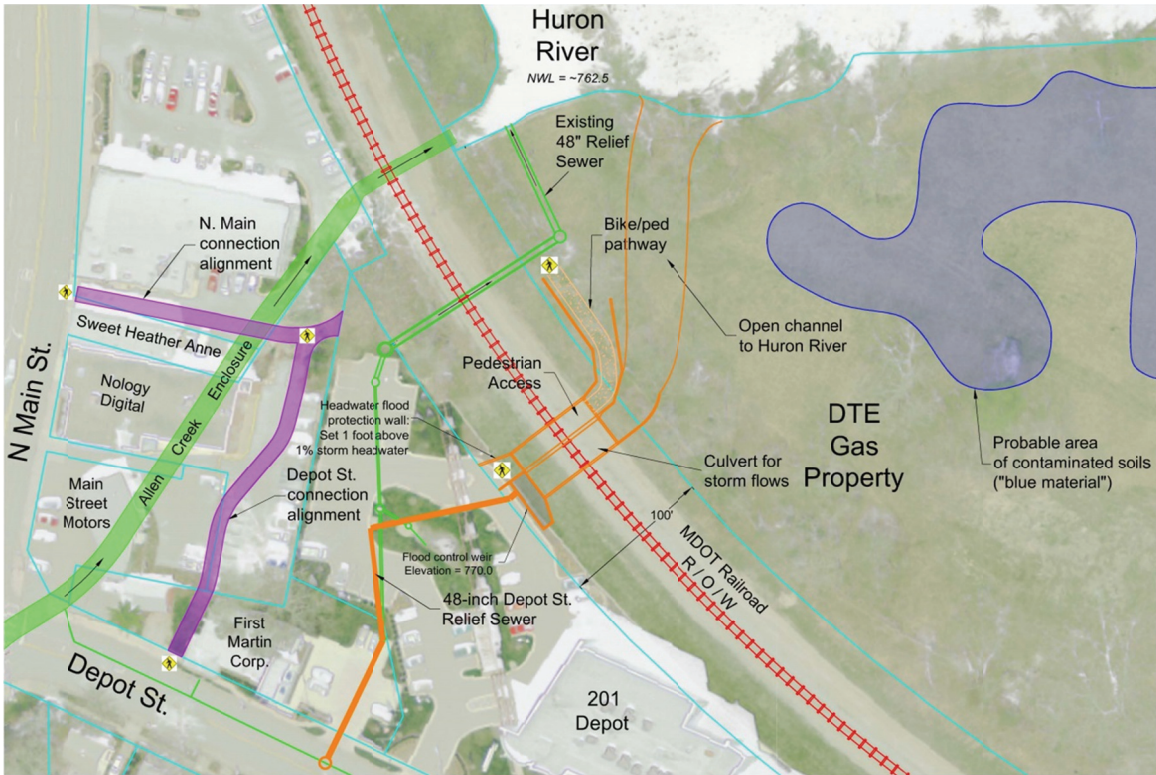

Figure 14
Preferred Alternative

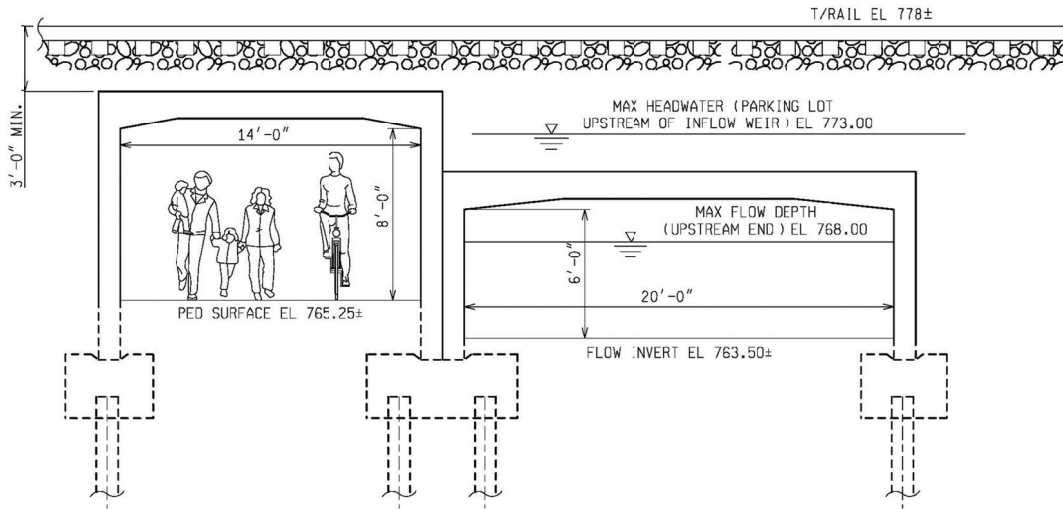

Figure 15
Preferred Alternative – Culvert Cross Section

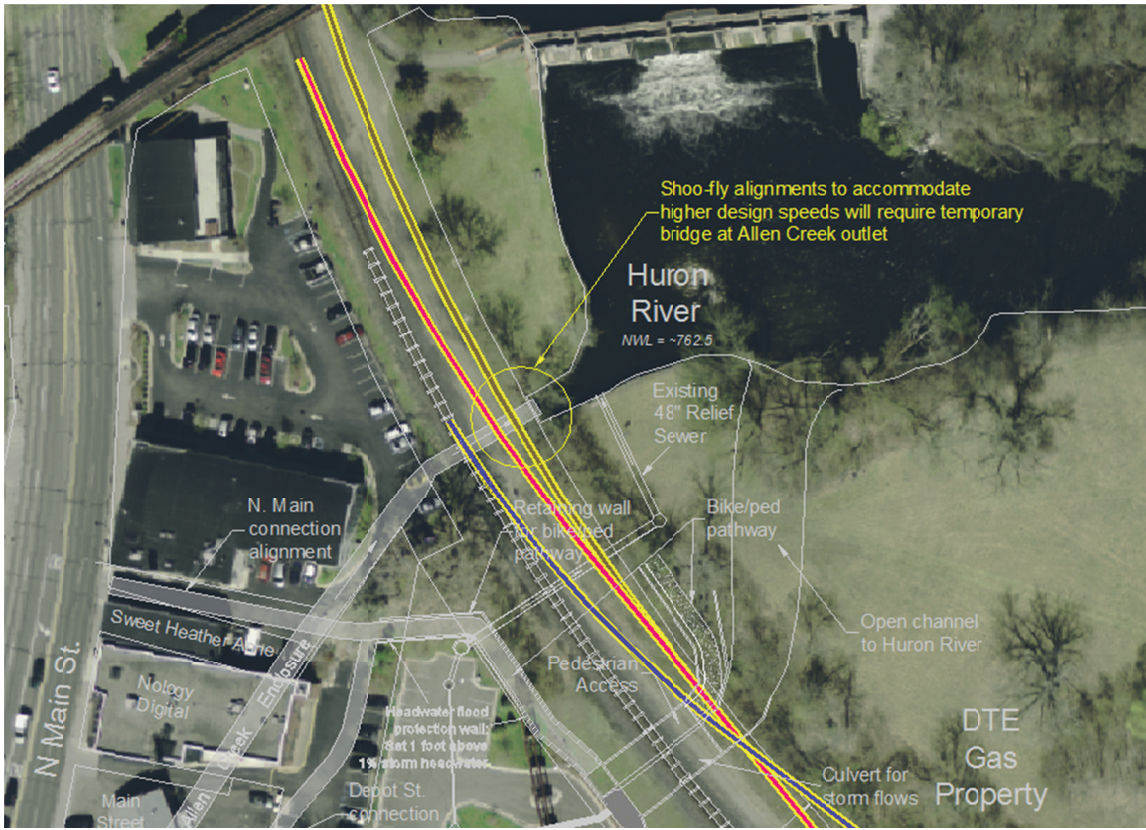

Figure 16
Potential Shoo-Fly Alignments

Appendix A

WCWRC Allen Creek Interior Inspection Report

WASHTENAW COUNTY WATER RESOURCES COMMISSIONER'S OFFICE
COMMISSIONER EVAN N. PRATT

Allen Creek Drain

Pipe Inspection

March 14, 2013



Inspector: William A. Castle

Allen Creek Drain Pipe Inspection

Scope: Conduct an interior inspection of the lower portion of the Allen Creek Drain from the outlet to Summit Street approximately (700 feet).

Purpose: To identify any interior deficiencies or structural flaws that impact the operation of the drain.

Introduction: An inspection was conducted on March 14, 2013; weather conditions at the time of inspection were sunny, with temps in the low 40's. Flow rate and water depth were 3.0 cfs and 2.19 feet. For referencing location and orientation of pipe connections and any defects the inspection was sectioned into 100 foot intervals with the first station starting at #100 and a clock position is facing upstream.

Summary: Overall the pipe is in good condition with a few minor maintenance issues.

- Concrete
 - Arch pipe -minor spalling in some locations; surface integrity is still intact
 - Box culvert - minor cracking evident with light spalling; surface integrity is still intact with the exception of two locations where light to medium spalling has occurred
- Pipe joints
 - Mortar is in good condition with the exception of two joints. The mortar is cracking with minor infiltration
- Pipe connections (taps)
 - Are in good condition with the exception of three showing signs of infiltration, one pipe is protruding into pipe approximately 18"
- Manhole Structures
 - Good condition
- Sedimentation
 - No sediment was observed in the system at the time of inspection

Report:

- **Station 100+45:** Repair with 3/8" sheet steel reinforcement (photos 1-4)
 - Sheet steel is pulling away from concrete wall creating 1"-3" gap on both upstream and downstream ends
 - Section of the sheet steel missing exposing repair, medium spalling see (photo 4)

Allen Creek Drain Pipe Inspection

- Station 100+65 (clock position 2): Crack in wall, seam Leak (photo 5)
 - Concrete deteriorating, medium spalling with infiltration.
- Station 100+90: Pipe Transition (photo 6,7)
 - Pipe shape changes from a 8'h x 10'w box culvert to 8.5'h x 14'w arch
 - Minor cracks in grout (photo 6)
- Station 200+00 (clock position 4): 12" Tap (photo 8)
 - Clay, good condition
 - Light flow
- Station 200+82: 6" and 12" Tap (photo 9,10)
 - 6" clay tap (clock position 3), good condition, (photo 9)
 - No flow
 - 12" clay tap (clock position 9), good condition, (photo 10)
 - No flow
- Station 200+95 (clock position 9): 12" Tap (photos 11,12)
 - HDPE, good condition
 - Poor seal around pipe, pipe is extending approximately 18" into drain
 - No flow
- Station 200+95 (clock position 3): Manhole #1 (photos 13,14)
 - Brick, good condition
- Station 200+98 (clock position 4): 18" Tap (photos 15,16)
 - Clay, poor condition
 - Bad seal around pipe connection
 - Joint leak in first section of pipe (photo 16)

Allen Creek Drain Pipe Inspection

- Cracks in clay pipe sections of tap
- No flow
- Station 300+5: Pipe joint (photo 17)
 - Crack in grout
 - Minor infiltration
 - Light spalling
- Station 300+74 (clock position 1): 6" Tap (photo 18)
 - Cast iron, good condition
 - No flow
- Station 300+80 (clock position 2): 6" Tap (photo 19)
 - PVC, good condition
 - No flow

No deficiencies, structural flaws or taps were observed between stations 300+80 to 500+11.

- Station 500+11 (clock position 9): Bulk head (photos 20,21)
 - Good condition with minor infiltration
 - Mortar skim coat is cracking and breaking away from brick around pipe
- Station 500+20 (clock position 8): 36" Tap (photo 22)
 - Concrete, good condition
 - Minor infiltration around joint
 - Light flow
- Station 500+22 (clock position 4): 12" Tap (photo 23)
 - Clay, good condition
 - Light flow

Allen Creek Drain Pipe Inspection

- Station 600+20: Pipe joint (photos 24,25)
 - Minor infiltration
- Station 600+30: 4" Tap 2 each (photos 26,27)
 - Clay, good condition (clock position 4),(photo 26)
 - No flow
 - Clay, good condition (clock position 9),(photo 27)
 - No flow
- Station 700+58 (clock position 2): 6" Tap (photo 28)
 - Bulk headed, good condition
- Station 700+65 (clock position 7): 12" Tap (photo 29)
 - Clay, good condition
 - Light flow
- Station 800+20: 3" Tap, 12" Tap, Manhole # 2 (photos 30,31,32)
 - 3" tap (clock position 4) (photo 30)
 - Clay, good condition, light flow
 - 12" Tap (clock position 2) (photo 31)
 - Concrete, poor condition, curb inlet, no flow
 - Manhole (clock position 9), (photo 32)
 - Brick, good condition

Allen Creek Drain Pipe Inspection



Photo 1 Station 100+45: steel reinforcement



Photo 2 Station 100+45: steel reinforcement



Photo 3 Station 100+45: steel reinforcement

Allen Creek Drain Pipe Inspection



Photo 4 Station 100+45: old repair light to medium

spalling



Photo 5 Station 100+65: crack in wall, seam leaking

light to medium spalling



Photo 6 Station 100+90: pipe transition, good

condition, minor cracking in grout

Allen Creek Drain Pipe Inspection



Photo 7 Station 100+90: pipe transition, good

condition



Photo 8 Station 200+00: 12" clay pipe, good condition



Photo 9 Station 200+82: 6" clay pipe, good condition

Allen Creek Drain Pipe Inspection



Photo 10 Station 200+82: 12" clay pipe, good

condition



Photo 11 Station 200+95: 12" HDPE pipe, good

condition protruding into drain approximately 18", poor joint seal



Photo 12 Station 200+95: 12" HDPE pipe, good

condition

Allen Creek Drain Pipe Inspection



Photo 13 Station 200+95: manhole #1, good condition



Photo 14 Station 200+95: manhole #1



Photo 15 Station 200+98: 18" clay pipe, poor joint

seal

Allen Creek Drain Pipe Inspection



offset joint

Photo 16 Station 200+98: 18" clay pipe, cracks and



Photo 17 Station 300+5: seam leak, crack in grout



condition

Photo 18 Station 300+74: 6" cast iron pipe, good

Allen Creek Drain Pipe Inspection



Photo 19 Station 300+80: 6" PVC pipe, good condition



coat cracking, minor infiltration

Photo 20 Station 500+11: bulk head, mortar skim



Photo 21 Station 500+11: bulk head

Allen Creek Drain Pipe Inspection



Photo 22 Station 500+20: 36" concrete pipe, good

condition

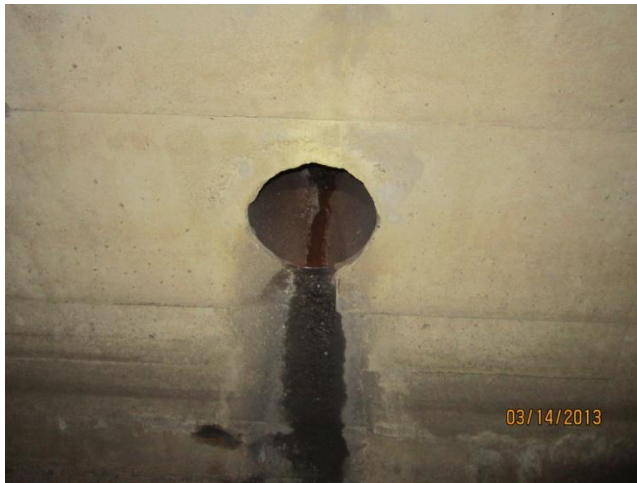

Photo 23 Station 500+22: 12" clay pipe, good

condition



Photo 24 Station 600+20: joint leak

Allen Creek Drain Pipe Inspection



Photo 25 Station 600+20: joint leak, crack in grout



Photo 26 Station 600+30: 4" clay pipe, good

condition

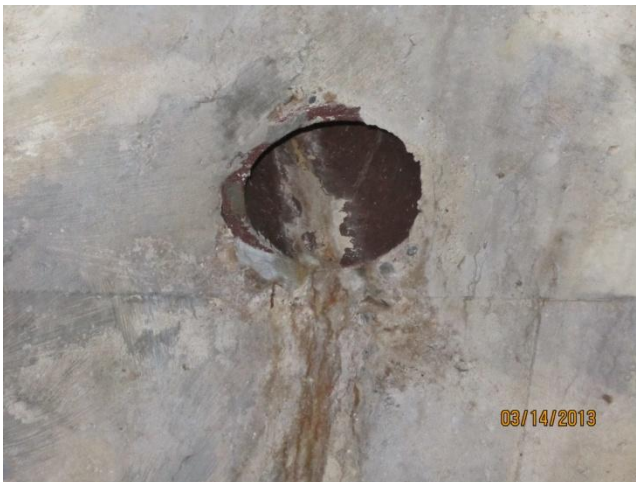

Photo 27 Station 600+30: 4" clay pipe, good condition

Allen Creek Drain Pipe Inspection



Photo 28 Station 700+58: 6" bulk head, good

condition



Photo 29 Station 700+65: 12" clay pipe, good

condition

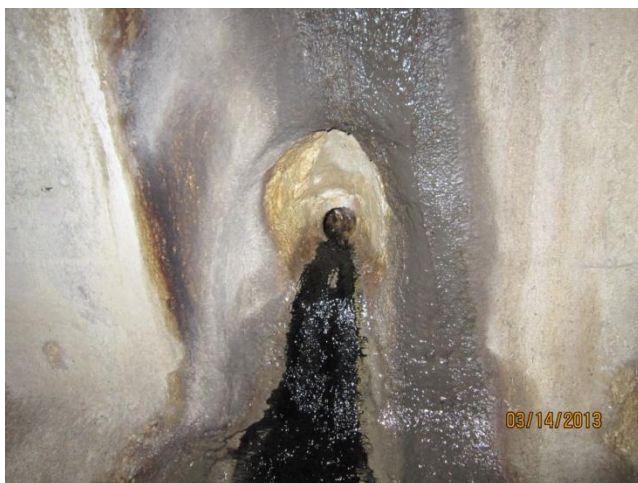

Photo 30 Station 800+20: 3" clay pipe, good

condition, black staining on pipe wall

Allen Creek Drain Pipe Inspection



Photo 31 Station 800+20: curb inlet, poor condition



Photo 32 Station 800+20: manhole #2, good condition

Appendix B

Railroad Issues and Key Correspondence

August 19, 2013, Ann Arbor Rail Embankment Flood Mitigation Field Meeting

Initial draft summary notes for review by meeting participants only.

Attendees: Eli and Jerry, CAA

Shaun and Juan, MDOT

Field meeting walkabout included review of rail corridor and proximity to Argo Dam, Argo Cascades, DTE property and potential future use, proposed Allen Creek Greenway alignment, Border-to-Border trail, trespassing, relationship of RR alignment to Barracuda Building, and other means of access to proposed drainage area.

Following walkabout the group met in the CEC Conference room and reviewed several technical report information items including presentation boards illustrating drop in flood levels, various storm water opening designs and two storm water and pedestrian crossing options. The following points reflect key issues addressed during the sessions. They are not presented in priority order and are to be reviewed by all participants to assure they fully and accurately reflect the current status of this concept prior to public release. Initial notes prepared for review by Eli.

- MDOT accepts the provision of storm water openings, the pedestrian access requires more scrutiny as it introduces additional safety and maintenance considerations to the railroad.
- Design should minimize use or reliance on MDOT right of way.
- Transverse alignment is acceptable but not horizontal access along the corridor. (This is due to the need to accommodate a two track system, with appropriate maintenance access and a minimum of 30' separation from any path element to the active railroad.
- MDOT favors Option three, two culvert, over trestle bridge design among the pedestrian options for the following reasons:
 - Quicker installation
 - Reduced costs
 - Less maintenance
 - Easier to inspect
 - Less likely to attract graffiti
- City shall install protective fencing on both sides of rail along length of project
- MDOT will review and provide feedback on concept design elements.
- MDOT will coordinate with AMTRAK to conduct initial review of concepts.
- City will be responsible for all design and construction costs including maintenance of the structure.
- Shoo fly location requires additional consideration including optional location and design features. If the temporary Allen Creek crossing is to remain in place as a pedestrian bridge, it will be out of the MDOT right-of-way.
- Any future path across the Allen Creek opening will need proper separation from RR.

- There is an emerging agreement-in-principal the city can continue to develop the pedestrian option concept recognizing all elements in this memo are considered.
- City staff will see that the potential shoo fly alignments are added to the Tech memo being prepared by OHM, and provide the shoo fly graphic to MDOT.
- Preferred pedestrian access should be the western side with access from N. Main St.
- City and MDOT need to renew lease agreement for existing path

DRAFT

Key Preliminary Design Issues: Railroad

Prepared by: Bergmann Associates

History of the Line

The Michigan Line was purchased by the Michigan Department of Transportation (MDOT) in 2012 with ownership being transferred to them in early 2013. The former owner, Norfolk Southern, still utilizes the track with approximately four freight trains per day. MDOT purchased the line in order to upgrade and maintain the track to carry high speed passenger rail service from Detroit to Chicago. The rail passenger service is provided by Amtrak, who operates and maintains the track for MDOT. Amtrak currently runs six passenger trains per day. As improvements to the line are made, reliability of service will improve and MDOT projects increased ridership as a result. Studies are currently being completed to determine where areas of “double tracking” may be required. There are also plans for relocating Amtrak’s Ann Arbor train station which is located near this study area. MDOT’s Office of Rail is the permitting agent for the line and is the primary reviewer for all new crossings over or under the line.

MDOT/Amtrak Concerns

As part of this feasibility study, MDOT and Amtrak were consulted to provide input on the various concepts developed. MDOT’s primary concerns are public safety and protection of railroad traffic. For options which provide pedestrian access beneath the tracks, MDOT has expressed concern for the safety of users (high water events, poorly maintained lighting, being obscured from view, etc.). In addition, the new crossing will need to be maintained over its life in order to ensure train service is uninterrupted into the future.

In order to construct a new crossing within the railroad right-of-way, a permit must be obtained from the rail owner (MDOT). New crossings are reviewed for location, need, construction procedures, and future maintenance of the crossing and the tracks above it. If this project is advanced into the design phase, a Preliminary Engineering (PE) agreement will be required which would be executed between the City of Ann Arbor and Amtrak. This agreement allows for review of documents during the design phase, coordination meetings, and construction requirements to be incorporated into the specifications.

Once the project moves from the design phase into construction, a construction agreement will be required between the City of Ann Arbor and MDOT which dictates the method of construction, terms of maintenance for the crossing, and other items of coordination between the two agencies. As part of this agreement, costs for railroad flagging and any other force account work to be performed by the railroad owner (i.e. rail communication line relocation, temporary track work, etc.) will also be provided.

This project must consider MDOT and Amtrak’s concerns for a new crossing which includes the type of facility to be constructed. Due to maintenance and performance issues, MDOT prefers to use a ballast section over any new crossing (i.e. no direct fixation of the tracks to the structure). Furthermore, construction of a new crossing must be completed with no interruption to rail service. Any utilities within the railroad right-of-way will need to be maintained at project

cost. Finally, if a pedestrian path is desired within the railroad right-of-way (along the tracks), specific criteria will need to be coordinated with MDOT and Amtrak such as; offset to the tracks, pedestrian barriers to separate them from rail traffic, and access to the right-of-way. Due to the concerns noted above, strong justification of a new crossing is required in order for MDOT to permit a new crossing within their right-of-way.

Geometrics

The length of the new crossing/tunnel will need to be finalized during the design phase. For this project, it has been assumed that the structure will need to accommodate the existing track, a future track, and a maintenance-of-way area. The depth of the structure supporting the track must consider future maintenance of the line (tie replacement, resurfacing, drainage, etc.), functionality of the rail roadbed, and existing utilities. For this project, it is assumed that a minimum of three-feet will be required from the top of rail to the top of structure crossing below. This would allow for the depth of the ties, ballast section, and subballast material.

The track is situated on a horizontal curve and the speed of train service through this area can be tied to its radius. Because of this, consideration must be given to potential future changes by the railroad for track geometry (i.e. flattening of the curve to allow for faster trains). The existing Amtrak train station would typically limit speeds of passenger trains as they arrive and leave the station; however, there are plans for relocating the train station. Further south and east of the train station is the Broadway bridge which is the nearest area where pedestrians are permitted to cross over the railroad tracks.

The Ann Arbor Railroad has railroad tracks which cross over the Michigan Line just northwest of this project study area. The crossing is located near the Argo Dam which in turn is located northwest of the Allen Creek outlet (an enclosed drainage structure).

Constructability

Options which convey both the desired flood flows and pedestrians under the existing railroad berm include either a bridge, a large culvert, or pair of culverts. For the culvert option, a three-sided arch or flat top three-sided box section can be considered for the new crossing. In order to separate pedestrians from high water events, two culverts would be required to allow for the width of the pathway, as well as width for the floodway. The design of the culvert can be challenging for rail live loading with minimal cover and the use of flat top culverts may require a lower floor elevation due to the structural thickness of the top slab that is required. If a pedestrian pathway is not incorporated, a series of pipes can be installed under the railroad berm to convey the flood towards the Huron River with measures in place to keep unauthorized people from entering the culverts.

The bridge option will require a ballasted deck section and either a three span or one span structure can be considered. A one span option will require a longer individual span which would result in a deeper superstructure and thus a lower pathway. Railroad bridges require much larger elements than vehicular bridges in order to support the heavy train loads thus the depth of superstructures can be large.

In order to construct either option described above, a temporary shoo fly (or track runaround) can be constructed in order to allow rail traffic to continue uninterrupted while the structure is built. A temporary shoo fly must be designed for desired train speeds (to be coordinated during the design phase), existing constraints (Ann Arbor Railroad bridge, Allen Creek Outlet, and Amtrak Train Station), and may require temporarily operating the railroad outside of the railroad right-of-way. Depending on the offset provided during construction between the shoo fly and the proposed crossing, temporary sheet piling and tiebacks may be required to hold back the earth supporting the train live loading along the shoo fly. The challenges and costs associated with shoo fly methods of construction are unique to each location and must be carefully coordinated with the railroad owner and operating agency (MDOT and Amtrak).

An alternative to shoo fly construction is a “roll in” or “slide in” method where the proposed bridge is built offline and then a short duration; or series of short duration train closures, are scheduled in which the new bridge is slid into its final position followed by completion of the track work above. In this method, no temporary track is required as trains continue to use the existing track until the scheduled outage, where the new crossing is built and then trains are able to use the new facility immediately after opening. This method of construction is common in the railroad industry where shoo fly construction is not feasible and there is a strong need for a new crossing. For this project, MDOT and Amtrak may not permit the short term closures that would be needed; however, funding opportunities for innovative construction techniques may be available which are similar to FHWA’s Every Day Counts initiative.

Another method of construction to consider is a bore and jack system in which the structure is installed beneath the tracks without open cutting the area below the railroad. This system can be considered for the options without pedestrians which utilize a series of constant diameter pipes. For the bridge and culvert options, boring and jacking under the live railroad tracks may not be feasible given the size and proximity between the structure and the tracks.

Phone Memorandum

For: Allen Creek Railroad Berm Opening Feasibility Study

Date of Meeting: February 1, 2013 (AM)

Location: Telephone Discussion

Attendees: Jeremy Hedden (Bergmann Associates)
Shaun Bates (MDOT-Office of Rail)

Bergmann Associates contacted MDOT's Office of Rail to discuss any input they may have on the subject project and the possibility of utilizing the culvert as a pedestrian underpass. The following is a summary of the phone conversation which was communicated to OHM and Shaun Bates in a follow up email dated February 1, 2013.

Item #1 superseded by City of Ann Arbor meeting with MDOT Office of Rail on August 19, 2013.

- 2) To deter access, MDOT would prefer that the following be considered for the proposed hydraulic opening:
 - a. Utilize an enclosed drainage system so that the facility is not accessible.
 - b. Provide sloped end sections with grates to block entry into the pipes used through the railroad berm.
 - c. Size the culverts so as to deter pedestrian use. Consider elliptical pipes.
- 3) Construction of the culverts would need to be done using jack-and-bore methods to allow train service to continue uninterrupted during installation.
- 4) In order to approve a new hydraulic opening in the railroad berm, MDOT will require the following:
 - a. Evidence that alternative methods of alleviating the flood conditions have been investigated and dismissed.
 - b. Analysis which shows that the installation of a new hydraulic opening will not result in adverse flooding impacts on the Huron River side of the railroad berm.
 - c. Analysis which shows that the flood waters from the developed side of the railroad berm will be able to be conveyed to the river (i.e. that the river side of the railroad berm will not already be flooded).
- 5) The depth of the proposed hydraulic opening would likely need to be at least 3 feet below the top of rail to ensure that the rail subballast is not impacted by construction. The depth of the culvert will also need to be approved by Amtrak.

Item #6 superseded by City of Ann Arbor meeting with MDOT Office of Rail on August 19, 2013.

- 7) MDOT would be open to reviewing options for a pedestrian path along the railroad within their ROW, however, they would need to see any options being considered.



Phone Memorandum

Shaun indicated that once the Amtrak station is relocated to its proposed location, there may not be a need for a pedestrian path along the rail ROW in this area.

- 8) Shaun indicated that he would try to attend the TAC meetings for this project but later confirmed he would not be able to attend the meeting scheduled for February 19, 2013.
- 9) We concluded the call and I thanked him for his time in reviewing this matter.



Phone Memorandum

For: Allen Creek Railroad Berm Opening Feasibility Study

Date of Meeting: March 6, 2013 (AM)

Location: Telephone Discussion

Attendees: Jeremy Hedden (Bergmann Associates)
Shaun Bates (MDOT-Office of Rail)

Bergmann Associates contacted MDOT's Office of Rail to discuss further input they may have on the subject project and the possibility of utilizing the culvert as a pedestrian underpass which is separated from the flood waters anticipated. This conversation was in follow up to the discussion originally held on February 1, 2013. The following is a summary of the phone conversation which was communicated to OHM and Shaun Bates in a follow up email dated March 11, 2013.

- 1) I informed Shaun that the City of Ann Arbor is interested in providing pedestrian access under the tracks still and have come up with additional options to consider. These include a separate culvert for pedestrians which is kept 'in the dry' as well as a three span trestle option with an impervious divider wall to keep the walkway dry.

Item #2 superseded by City of Ann Arbor meeting with MDOT Office of Rail on August 19, 2013.

- 3) Shaun noted that they would review any plans for an overhead pedestrian crossing, however, this would likely be separate from this project.
- 4) Shaun reiterated from our previous discussions that MDOT will require justification of the hydraulic opening at the site recommended (see previous memo 2/1/13). Shaun added that the location of the new hydraulic opening (if required) should be located at an existing crossing, if possible. If a crossing is introduced away from any existing there will need to be justification for why the proposed location is needed.



Appendix C

Meeting Summary – Mike Martin

Meeting Summary

Allen Creek Berm Study – Meeting with Mike Martin

March 1, 2013, 9:00 a.m.

City Hall – 4th Floor Conference Room

Attendees: Mike Martin, Jerry Hancock, Troy Baughman, Eli Cooper, Greg Kacvinsky

Key Discussion Topics

This document summarizes the key issues discussed at this property owner coordination meeting with Mike Martin.

1. Greg Kacvinsky described the work OHM has done to identify flooding extents and flood patterns. Mike Martin said he was well aware of the flood patterns, given his history of observing flooding in and around his properties.
2. Greg described the alternatives discussed at the TAC Meeting #2, including the hydraulic (no pedestrian) option, as well as the pedestrian options. For the pedestrian options, it is recommended that one of two alternatives be selected:
 - a. 2-cell culvert: one lower culvert for flood conveyance and one higher culvert for pedestrians. The higher culvert would be protected by flood walls at the upstream and downstream sides to prevent headwater or tailwater from entering the pedestrian viaduct.
 - b. Trestle bridge: a 3-span trestle would provide a more “open” feel and would accommodate both flood conveyance and pedestrian access. A flood wall would still be required to separate the pedestrian component and prevent headwater/tailwater from entering the pathway area. The depth of structure for the trestle may be a problem (it would limit headroom for the pedestrians), so this alternative is still being vetted.
3. Mike Martin said that the best location for a flood control structure is at the north end of the 201 Depot parking lot (where the Option 1 spillway/culverts is located). Mike questioned whether the location of the pedestrian options was appropriate, as he said the north side of the parking lot is lower. Greg Kacvinsky and Jerry Hancock pointed out that the contours indicate that both locations are at an elevation of 770 and both locations would work equally well for a flood control structure.
4. Mike Martin made it clear that he is more worried about the frequent (i.e. 1-year, 2-year, 5-year) storm events that cause flooding on his parking lot and threaten to damage automobiles. Greg Kacvinsky said that OHM’s key objective was to lower the 100-year floodplain as much as practical, but that any recommended improvement could consider the potential to further reduce flooding potential on 201 Depot for more frequent storms.
5. Mike Martin suggested that the pedestrian crossing be located immediately north of the Depot / 5th intersection. Greg Kacvinsky said that this may pose problems with the required railroad shoo-fly which would need to be extended east, potentially conflicting with the Broadway Avenue bridge. Additionally, this area is higher in elevation and would require significant ramping to meet ADA requirements.
6. Greg Kacvinsky said that the proposed flood control alternatives could include some modifications to the parking lot at 201 Depot to accommodate better drainage into the primary storm outlet. This will help to reduce the chances of standing water within the parking lot for more frequent storm events.

7. Mike Martin discussed the potential for a check valve on the 36-inch Depot Street storm sewer. Mike said it would prevent reverse flow from Allen Creek towards 201 Depot. Greg Kacvinsky said it may help for smaller storm events, but it would not prevent major flooding for larger storms. Greg recommended that the Depot Street storm sewer be redirected north into the 201 Depot site and to the flood control structure proposed as part of this study. This will help to isolate 201 Depot from the immediate hydraulic impacts of Allen Creek and will provide a better outlet for the Depot Street storm sewer.

ACTION ITEMS:

1. OHM will coordinate with Jeremy Hedden (Bergmann Associates) to contact the MDOT Rail Office to discuss the newer pedestrian options, including our goal to isolate floodwaters from the pedestrian crossing. Ideally, this coordination will occur before the first public meeting.
2. As part of the improvement alternatives discussed in the Allen Creek Berm technical memorandum, OHM will provide guidance and cost estimates to enhance the parking lot drainage at 201 Depot to further reduce flood potential during more frequent storm events.
3. OHM will provide a detail and cost for a trestle bridge option.
4. OHM/Bergmann will look at the feasibility of a pedestrian viaduct near the Depot/5th intersection. The Broadway Avenue bridge supports may pose a conflict with a shoo-fly to accommodate this construction.

Appendix D

Benefit Cost Analysis (BCA) Tool – Summary Table
Example Based on Alternative 1a

**FEMA BCA Tool
Summary of Benefits and Costs by Parcel**

Address	Present Value of Mitigation Benefits *	Mitigation Costs **	Parcel BCR
105 E. Summit Street	\$138,538	\$67,970	2.04
106 Depot Street	\$57,716	\$67,970	0.85
109 E. Summit Street	\$187,436	\$67,970	2.76
110 E. Summit Street	\$68,566	\$67,970	1.01
112 E. Summit Street	\$125,366	\$67,970	1.84
113 E. Summit Street	\$122,817	\$67,970	1.81
114 Depot Street	\$305,081	\$67,970	4.49
116 E. Summit Street	\$40,230	\$67,970	0.59
117 E. Summit Street	\$282,678	\$67,970	4.16
120 Depot Street	\$141,001	\$67,970	2.07
120 E. Summit Street	\$261,629	\$67,970	3.85
121 E. Summit Street	\$251,715	\$67,970	3.70
124 E. Summit Street	\$202,788	\$67,970	2.98
126 Depot Street	\$90,477	\$67,970	1.33
126 E. Summit Street	\$210,137	\$67,970	3.09
127 E. Summit Street	\$151,438	\$67,970	2.23
735 N Main Street	\$53,097	\$67,970	0.78
809 N. Fourth Avenue	\$138,324	\$67,970	2.04
115 Depot Street ***	\$126,450	\$67,970	1.86
201 Depot Street ***	\$768,835	\$67,970	11.31
304 Depot Street (Lumber yard)	\$169,322	\$67,970	2.35
304 Depot Street (Store)	\$141,867	\$67,970	2.09
304 Depot Street (Tavern)	\$89,984	\$67,970	1.32
721 N. Main Street	\$98,001	\$67,970	1.44
730 N Main Street	\$129,597	\$67,970	1.91
906 N. Main Street	\$59,874	\$67,970	0.88
907 N. Main Street	\$125,894	\$67,970	1.85
912 N. Main Street ***	\$916,041	\$67,970	13.48
918 N. Main Street	\$48,227	\$67,970	0.71
924 N. Main Street	\$13,529	\$67,970	0.20
800 N. Main Street	\$9,086	\$67,970	0.13
Totals	\$5,525,741	\$2,107,070	2.62

* Present value calculated over 50-year period at 7% discount rate (per FEMA Benefit-Cost guidance)

** Total project cost of \$1.9 million + \$0.207 million maintenance discounted over 50-year period spread evenly over all parcels

*** Includes benefit of reduced automobile damages (reduced frequency of parking lot flooding)

Properties within or adjacent to FEMA Floodplain
 Allen Creek Berm Feasibility Study

<u>Address</u>	<u>First Floor Elevation (as Surveyed)</u>	<u>Street</u>
105	773.27	East Summit Street
109	773.61	East Summit Street
110	777.40	East Summit Street
112	775.29	East Summit Street
113	774.83	East Summit Street
116	775.28	East Summit Street
117	774.38	East Summit Street
120	775.68	East Summit Street
121	774.49	East Summit Street
124	775.72	East Summit Street
126	775.75	East Summit Street
127	774.63	East Summit Street
111	Not Surveyed	West Summit Street
113	Not Surveyed	West Summit Street
625	Not Surveyed	North Main Street
717	Not Surveyed	North Main Street
721	778.35	North Main Street
724	Not Surveyed	North Main Street
730	775.09	North Main Street
735	778.25	North Main Street
803	781.98	North Main Street
805	777.39	North Main Street
807	782.00	North Main Street
811	784.01	North Main Street
906	776.13	North Main Street
907	778.85	North Main Street
912	771.41	North Main Street
918	778.66	North Main Street
920	778.59	North Main Street
924	779.56	North Main Street
940	782.45	North Main Street
106	774.18	Depot Street
110	775.04	Depot Street
114	773.51	Depot Street
115	771.24	Depot Street
120	774.01	Depot Street
126	775.03	Depot Street
201	770.95	Depot Street
229	774.68	Depot Street

Properties within or adjacent to FEMA Floodplain
Allen Creek Berm Feasibility Study

First Floor Elevation

<u>Address</u>	<u>(as Surveyed)</u>	<u>Street</u>
304	776.39	Depot Street
310	779.03	Depot Street
325	777.51	Depot Street
425	777.02	Depot Street
<hr/>		
717	Not surveyed	North Fourth Street
719	Not surveyed	North Fourth Street
809	773.83	North Fourth Street
Wheeler Park		

Appendix E
Public Meeting Summaries

Allen Creek Berm Opening Feasibility Study
3/13/13 Public Meeting Notes

Q&A

- **Q:** If a second track was put in, would construction be able to take place simultaneously?
A: The railroad has a concern with construction too close to a live track.

- **Q:** Has daylighting the creek been considered?
A: Daylighting is a future goal, but is not a part of this project and it would represent a very large capital investment. This project focuses on lowering the floodplain in the area.

- **Citizen Comment:** Consider bringing path up by Fuller and Maiden Lane. Look at the project in a larger view, not just this area.

- **Q:** Why is MDOT not keen on pedestrian access? There needs to be a way to cross the railroad tracks safely.
A: MDOT has liability and pedestrian safety concerns. Also, MDOT has concerns about who will assume the long-term maintenance of lighting and other safety features.

- **Q:** The location shown in Alternative 1 seems to be the best location for this project. Why are the other alternatives located elsewhere?
A: The location in Alternative 1 would require a longer extension of the sidewalk in order to accommodate pedestrian access. In order to build the shoofly (temporary track relocation) needed to construct a pedestrian crossing in the location of Alternative 1, the shoofly alignment would conflict with the bridge pier for the Ann Arbor railroad, which is just north of the project area. A temporary bridge would need to be built for the temporary railroad track, which would increase costs.

- **Q:** *Questions about the sidewalk behind the pineapple building*
- **Q:** Why not do a large enough jack and bore instead of a shoofly?
A: The tunnels would be very large, and would require specialized and expensive construction techniques. Additionally, the diameter required to perform the tunneling would likely interfere with the ballast and tracks.
 - **Citizen Comment:** They did this at Leslie Park Golf Course
Response: Yes, however this was smaller than we would need to fit our current alternatives and there was an abundance of vertical clearance between the top of tunnel and the railroad tracks.

- Q:** Who would own the facility once built?

A: Ownership is case-by-case. Typically, the railroad permits the building of the facility. The City would likely negotiate ownership and liability with the railroad.
- Citizen Comment:** I see this project as a mutual benefit. Reducing the water flowing over the tracks is some responsibility of the railroad.

Response: Yes, we agree that this would be a benefit to the railroad. We will include this in our final report, however we cannot guarantee what their response will be.
- Q:** There needs to be a way to safely cross the railroad. What does the railroad offer for solutions?

A: MDOT has recently taken ownership of the rail and may not fully understand the need for such a project, as pedestrian access is typically a local need. MDOT did mention that they would look at a pedestrian overpass option.
- Q:** How confident are you that there are not contaminated soils outside of the blue area on the map?

A: We are not confident on this. We do not know the exact extents of the contamination. Soil testing would need to be done. Any future project would need to accommodate the handling and disposal of contaminated soils, including design provisions to prevent an interaction between contaminated groundwater and the Huron River.
- Q:** Couldn't you split the size of the culvert into two culverts that can be jack and bored without the specialized equipment?

A: With the ASHTO standards, even a single directional culvert would be too large to jack and bore with standard equipment and would not meet minimum vertical clearance requirements to the track bed.
- Q:** I would suggest a hybrid approach – have the water component in one place, and the pedestrian in another. Why do they have to be next to each other?

A: They do not have to be next each other; however that is what we are studying with this project. Also, the railroad would likely like to minimize areas with crossings. Separating the projects could be an option, but the advantages may be tough to sell.
- Q:** Couldn't a 7' clearance be used for this project, and use jack and bore technique?

A: We are looking for a shared-use non-motorized path. ASHTO minimum clearance is 8'. We need an 8' minimum to be eligible for state and federal dollars.

- **Q:** What is the life expectancy for the Allen Creek enclosure?
A: We do not know for sure. The enclosure is in fairly good condition based on WCWRC inspection. The report will recommend a more frequent maintenance/inspection schedule to extend the life of this asset.
- **Q:** Is the open channel option in Alternative 1 and Alternative 2 a water quality issue?
A: An open channel could provide a water quality benefit by filtering/removing some pollutants prior to entering the Huron River.
- **Citizen Comment:** Vision of 721 N Main, path across Summit, Main, Depot. There needs to be a pedestrian underpass along the rail at some point. The City should do whatever it takes to get an underpass. Such an underpass should have a unique character and should be inviting to local pedestrians.
- **Q:** Why not just have one culvert for people and floodwater and people just will not be able to go through during heavy rains?
A: The railroad did not like this idea. The railroad does not want to comeingle floodwaters and pedestrians.
- **Citizen Comment:** The railroad will cooperate. They would much rather have the people in a culvert or bridge than walking over their tracks.
- **Q:** Why not a tunnel with a grated floor so that water will fill up in the culvert a few feet below where people would be traveling?
A: There is the same concern with mixing water and pedestrians, and the culvert would fill with water during larger storm events anyway, creating a public safety concern.
- **Q:** Is there a timeline/goal for this project?
A: There is not a schedule for the construction of something. This is the study portion of the project. A timeline could also depend on FEMA funding availability.
- **Q:** *Question about the pilings – how/why were these chosen?*
A: Since this is a study of feasibility, soil borings were not taken in the exact location of the proposed bridge. Piles are usually used for the types of foundations recommended for this project.

 - The City has shared existing soil borings near the proposed structures. These borings show high groundwater and the presence of soils that would likely require structural pilings.

- **Q:** Are there examples of pedestrian rail underpasses in Michigan?
A: Not a lot. Greg Kacvinsky (OHM Advisors) has experience working on a project in Urbana, Illinois that combined water and pedestrians through a box culvert. The culvert was designed to occasionally convey water, and appropriate safety measures were designed to accommodate this. The rail was not frequently used and was owned by Norfolk Southern.
- **Q:** In an alternative with separate culverts for people and water, what would keep people out of the culvert for water?
A: MDOT shared this concern also. There would be signage installed to warn people of the potential for floodwaters. Additional measures, such as steel grating, can be installed to prevent pedestrians from entering the wrong structure.
- **Citizen Comment:** It is better to have a more open space with water than with one with grates and such to keep people out. It is important to have avenues for escape.
- **Citizen Comment:** It is important to have a path where people will travel. People will come from the Main Street side.
Response: The area we are looking at would be a preferred route and we believe people would want to use this route to reach areas such as the Argo Cascades.

Sign-In Sheet

Name (Please Print):	Group/Organization:	E-mail address:
1. Greg Kacvinsky	OHM Advisors	greg.kacvinsky@ohm-advisors.com
2. Jeremy Hedden	BERGMANN ASSOC	jhedden@bergmannpc.com
3. Lesley Rivera	City AZ -STV	lrivera@azgov.org
4. Dennis Wojcik	WCWRC	wojcikd@ewashtenaw.org
5. Ron Cavallaro	OHM advisors	Ronald.cavallaro@ohm-advisors.com
6. Bryan Dage	OHM Advisors	Bryan.Dage@OHM-Advisors.com
7. THOMAS E. BRUCHER	HCPond B / ACWG	HCPondB@aol.com
8. ALICE RALPH	ALLEN CR GREEWAY CONSERVATION	ajralph@comcast.net
9. DARREN MCKINNON	NMHEVTR	dgmckinnon@gmail.com
10. Michelle Stabb	Huron River Place, LLC	mstabb@med.umich.edu
11. JOE E. O'NEAL	ACGC	joneal@onealconstruction.com



Sign-In Sheet

Name (Please Print):	Group/Organization:	E-mail address:
12. N. KAPLAN	_____	snowshoe@comcast.net
13. Rita Mitchell		ritamitchell@gmail.com
14. Lerry Deck	WBWC	LDeck3@aol.com
15. Carolyn Grawi	Ann Arbor CIC / WBWC	cgrawi@aacil.org
16. Gwen Nystuen		gnystuen@umich.edu
17. John D Nystuen		nystuen@umich.edu
18. Cathy Antonakos		cathya@umich.edu
19. Nate LaMoreaux		nate.lamo@gmail.com
20. Julie Grand	N. Main Task Force / DAC	jbgrand@umich.edu
21. Cyndi Ives	N. Main Taskforce	Cyndiives@gmail.com
22. David Crouse	Ann Arbor Rowing Club	crousedavid@hotmail.com



Allen Creek Berm Opening Feasibility Study
12/04/13 Final Public Meeting Feedback

Feedback Form:

RESULTS OF THE ALLEN CREEK RAILROAD BERM FEASIBILITY STUDY

Is there any additional feedback that you would like to share related to the results of the Allen Creek Railroad Berm Feasibility Study?

- Very thorough & well presented. Go for it!
- Preferred alternative #3 (\$4.3 M) is GREAT + everyone is benefited!
- The economic gains from this approach both in flood control and the value of pedestrian access to the border to border trails (east and west) will be enormous. The North Main Task Force was fully behind this direction. Both flooding and transportation funds will be available. – Ray Detter
- Need flood reduction, ped + bike access, cost saving due to (increased) property values, reduced car flooding, Climate change is now, we need to plan. Greenway use demand access to river. DTE pollution is very high, need clean up. This is what the City is here for to help those who can't do alone. – vpc@acwg.org
- I think if flood mitigation efforts are to be attempted in this area they should be handled by those private interests benefitting from the project. Why not fund this effort by setting up a special tax assessment district of people who live and work in the floodplain.

City Response: The benefit from a reduced or lowered floodplain would go far beyond the private property in the project area. Depot Street currently floods on a regular basis causing very unsafe conditions as people try to drive through the flood waters. Depot Street is a primary route to and from the University of Michigan Hospital (the largest employer in the City). The Ann Arbor Police routinely have to monitor this area during heavy rain events. Flooding on Main Street, Summit Street and Forth Avenue would also be reduced if the berm opening project were built.

SIGN-IN SHEET

Results of the Allen Creek Railroad
Berm Feasibility Study

Date: December 4th, 2013 Time: 6:30-7:30 PM
Location: Larcom City Hall- Basement Conference Room

Name (please print clearly):	e-mail address (please print clearly): By legibly providing your e-mail address you will be added to a distribution list on this topic; you will be emailed the meeting summary and other updates. You may request removal from the list at any time.
1. Nancy Schewe	nschewe@comcast.net
2. Stephen Schewe	sschewe@comcast.net
3. Nancy Schifferling	nshifferling@comcast.net
4. RAY DETTER	RDETTERR@UMICH.EDU
5. OVIDE BOMERLEAU	OVIDE@UMICH.EDU OVIDE@UMICH.EDU
6. Andy Tomer	
7. Vince Carano	VPC@ALWA.ORG
8. JOE O'NEAL	joneal@onealconstruction.com
9. PETER ALLEN	PETER@PtaLLen.COM
10. Jim Fleming	jim@Flemingartists.com
11. Jonathan Baskley	jbaskley@umich.edu
12. ALICE RALPH	ajralph@comcast.net
13. Rita Mitchell	ritamitchell@gmail.com



SIGN-IN SHEET

Results of the Allen Creek Railroad
Berm Feasibility Study

Date: December 4th, 2013 Time: 6:30-7:30 PM
Location: Larcom City Hall- Basement Conference Room

Name (please print clearly):	e-mail address (please print clearly): By legibly providing your e-mail address you will be added to a distribution list on this topic; you will be emailed the meeting summary and other updates. You may request removal from the list at any time.
14. Rogan Kehl	rokehlman@yahoo.com
15. Ingrid Avet	ingahuff@aol.com
16. Eric Lipson	ericlipson@yahoo.com
17. Darren McKinnon	dgmckinnon@gmail.com
18.	
19.	
20.	
21.	
22.	
23.	
24.	
25.	
26.	



Appendix F

TAC Meeting Summaries

MEETING SUMMARY



Meeting Date: December 19, 2012
Project: Allen Creek Railroad Berm Opening Feasibility Study
From: Gregory P. Kacvinsky, Orchard, Hiltz & McCliment, Inc.
Distribution: See attached attendance list

Key Discussion Topics

- The existing SWMM hydrologic/hydraulic model is currently undergoing revisions by CDM to include the impacts of overland (flood) routing. This will have a significant impact on peak flow rates. This work will not be completed before the Allen Creek Railroad Berm study is wrapped up. Therefore, the appropriate flow rates to use for the evaluation of flood reduction techniques are those flow rates listed in the 2012 FEMA Flood Insurance Study for Washtenaw County.
- Amy Kuras said that there was a feasibility study that reviewed bridge and culvert options in the vicinity of this project. This report should be submitted for the team to review.
- Dennis Wojcik will look into the potential for an interior inspection of the Allen Creek. This would require a horizontal confined space entry. Greg Kacvinsky said that OHM staff have the trained personnel to conduct the inspection, although this work is not in the current project scope.
- Greg Kacvinsky said that some information will be needed from the City to complete the Benefit-Cost Analysis (BCA). Information will include replacement value for City structures in Wheeler Park, as well as Net Income from area businesses. Given the sensitivity of the Net Income information for private businesses, this information should be retrieved by City staff and conveyed to OHM. *[OHM note: as an alternative to providing exact income figures, businesses could provide the City with an approximate figure or a range of income during the last 3-5 years]*
- Greg Kacvinsky discussed FEMA Pre-Disaster Mitigation Grant (PDM Grant) funding. Our early discussions with FEMA staff in Chicago (FEMA Region 5) have revealed that the City of Ann Arbor should be able to use the existing official floodplain elevations for Allen Creek to determine existing conditions, even if there is some doubt as to the accuracy of the floodplain elevations. Additionally, FEMA staff indicated that there are no funds in the current fiscal year to cover PDM Grant projects. Future funding will hinge on whether pending cuts to government programs will impact the PDM Grant program.

- Although a Letter of Map Revision (LOMR) will likely be a recommendation of this study, the City should go through the BCA and PDM Grant application process first, as the current “official” floodplain elevations will give the City a better chance of achieving a Benefit-Cost ratio above 1.0.
- Jeremy Hedden (Bergmann) provided an update on the status of the railroad. Although the transfer of the railroad right-of-way from Norfolk Southern (NS) to MDOT has already occurred, it will likely be at least a month (or more) until the dust settles and we are able to determine which parties will have interest/leverage over rail operations and how that will impact our recommendations. MDOT will formally assume operational control of the railroad in mid-February 2013.
- Although MDOT will likely have the leverage with respect to the construction methods and timing, the other users (NS and Amtrak) will have specific needs that may limit (or prevent) any temporary closure of the tracks to accommodate the construction of a bridge/culvert.
- Any future negotiations with MDOT should consider the fact that the City has close political relationships with MDOT rail representatives.
- When negotiating options with MDOT and their rail users, the project team will need to use the flood control aspects of this project as a key benefit to the railroad. Reducing the floodplain elevation will effectively take the tracks out of the floodplain and will reduce the probability of disruption to service.
- All survey will be conducted outside of the railroad right-of-way. The survey scope includes only measurements of the first floor elevations for the purpose of the BCA. The City will handle public notifications prior to the survey. The survey will likely be conducted during the week of January 7 or January 14 and will take 1-2 days. OHM will inform City staff prior to commencing the survey effort.
- There are likely contaminated areas on the west side of the Michcon/DTE site. OHM and the City need to meet with Michcon/DTE to discuss their environmental report and determine whether there is a possibility of building an outlet channel (north of the tracks) without impacting any contaminated areas.
- The first public meeting (late January / early February) will be used to inform the public about the goals of this project and discuss early options. It will be made clear that the first and primary goal is to control flooding. The secondary goal is to provide pedestrian access to the north side of the railroad tracks. A key question to answer as part of this process is “How important will it be to provide a pedestrian link across/under the railroad?”

- At the first public meeting, Jerry Hancock will provide a context to other ongoing City projects, including the North Main Street Vision, Allen Creek Greenway, and the proposed Greenway Park at 721 N. Main.

ACTION ITEMS

- Matt Naud will set up a meeting with Michcon and OHM. *[This meeting has already been scheduled for January 9, 2013]*
- Lesley Rivera will review potential dates for the first public meeting during the final week of January and first week of February and establish a final date/time for the public meeting.
- Dennis Wojcik will determine whether the Allen Creek drain maintenance budget can accommodate an internal inspection of the lower 1,000 feet (+/-) of the Allen Creek enclosure, from its outlet to Huron River upstream through the project area. Additionally, the project team needs to verify who will conduct the internal inspection.
- Jerry Hancock and Mike Nearing will meet to discuss any specific survey needs prior to the field survey effort (this should be done by January 7, 2013).
- Jeremy Hedden will check with MDOT on their site plan for a rail yard on the Michcon/DTE site. The site plan may contain good information to supplement the field survey.
- OHM will provide the City with a formal information request for property/business data within the project area to be used for the BCA.
- OHM will coordinate with the City prior to the first public meeting to discuss appropriate presentation materials.

SIGN-IN SHEET

Kickoff/Technical Advisory Committee Meeting

Date: December 19, 2012

Time: 2:00-4:00 PM

Location: Larcom City Hall- 301 E Huron Street- 6th Floor Conference Room

Name (Please Print)	Group/Organization
1. Lesley Rivera	City AZ - SPU
2. JEREMY HEDDEN	BERGMANN ASSOCIATES
3. Jerry Hancock	JHancock@adgov.org
4. Murat	murat.ulasir@ohm-advisors.com
5. Ron Cavallaro	roncavallaro@ohm-advisors.com
6. Molly Robinson	City of Ann Arbor Water Treatment Services
7. Matt Kowalski	A& Planning
8. Bryan Dage	OHM bryan.dage@ohm-advisors.com
9. Greg Kacinsky	ohm
10. Dennis Wojcik	WCWRC



Allen Creek Railroad Berm Opening Feasibility Study

Name (Please Print)	Group/Organization
11. Amy KURAS	Parks & Recreation City of Ann Arbor
12. Eli Cooper	Systems Planning City of Ann Arbor
13. Matt Naud	City #2
14.	
15.	
16.	
17.	
18.	
19.	
20.	
21.	
22.	



Meeting Summary

Allen Creek Berm Study – TAC Meeting #2

February 19, 2013, 2:30 p.m.
City Hall Basement Conference Room
Attendees: See attached sign-in list

Key Discussion Topics

- Greg Kacvinsky summarized the efforts made by the project team between the first and second TAC meetings. Greg asked the group whether any property owners or other stakeholders have brought up any issues about the project. Mike Martin has been the most vocal property owner to date, and has been coordinating with the City on some short-term solutions for the area, such as installing a check valve on the 36-inch Depot Street storm sewer.
- The North Main – Huron River Corridor Vision Task Force will likely have interest in this project and should be involved in future public coordination.
- Greg asked Dennis Wojcik about inspecting the Allen Creek enclosure. Dennis said that OHM can submit a fee proposal to perform an inspection, provided that it falls below the \$5,000 threshold for direct procurement. Greg said that OHM would get a fee proposal over to Dennis. City staff requested that the inspection be performed from the outlet upstream to the Summit / N. Main intersection (about 700 lineal feet).
- Murat Ulasir summarized the modeling effort and explained how the project team created a truncated model for the Allen Creek Berm alternative analysis. Mike Nearing asked why the project team didn't attempt to calibrate the model to better represent current system conditions. Greg Kacvinsky said that model calibration was not part of the scope of this study, although the Allen Creek model will be calibrated under CDM's ongoing contract for the storm sewer system modeling.
- Greg summarized a list of recommendations for the CDM team to use in their Allen Creek InfoSWMM model calibration. These recommendations include adding overland flow paths to account for a dual drainage system. This will better represent actual flows and flood potential along the Allen Creek corridor.
- Greg discussed the proposed hydraulic solutions and showed the group two separate schematics. Both options will help reduce the 100-year floodplain from 779.5 to about 773. The first option will consist of multiple 54-inch diameter pipes and will not accommodate pedestrians. The second option will consist of a pre-cast culvert section large enough to accommodate pedestrians and bicyclists. Greg also explained that the preferred outlet would consist of a wide open channel between the railroad and the Huron River. Although DTE Gas would prefer an enclosed pipe/culvert, Greg said that an enclosure would be cost-prohibitive. An open channel option can be naturalized with native grasses and can accommodate pedestrians using a boardwalk across the channel.
- The preliminary cost estimate for the first option (54-inch culverts) is approximately \$1.7-\$1.8 million.

- Greg discussed an alternative to a proposed check valve on the Depot Street storm sewer. A better option would consist of diverting the 36-inch Depot Street storm sewer north through the 201 Depot parking lot to the proposed culvert structure. This would solve two problems: First, it would prevent any backflow (reverse flow) from the Allen Creek enclosure towards 201 Depot. Second, the new outlet would provide more hydraulic capacity and would reduce roadway and parking lot flooding during moderate (i.e. 1-inch to 2-inch) rainfall events.
- Greg summarized the early results of the Benefit Cost Analysis (BCA) Tool. Based on the information fed into the BCA tool, the mitigation benefits from the proposed hydraulic improvements would approach \$3.5-\$4.0 million. The Benefit-Cost Ratio (BCR) for the first option (54-inch culverts) would be approximately 2.0, which should justify an application for a FEMA Pre-Disaster Mitigation Grant.
- Jeremy Hedden summarized the conversation with MDOT Rail Office staff (Shaun Bates) about a new culvert under the railroad. A meeting summary was handed out to the TAC attendees. In summary, MDOT indicated that they would resist permitting any pedestrian crossing under the railroad due to risk issues relating to culvert inundation during wet weather events. Eli Cooper stated that his conversation with MDOT staff about this issue went nowhere and it appears that MDOT is sticking with Shaun Bates' initial feedback. MDOT would permit boring and jacking culverts under the railroad, provided that design constraints are met, including specific measures to discourage and prevent pedestrian access to the pipes.
- Jeremy and Greg both stated that the cost of the pedestrian option would likely be at least double that of the culvert option, largely due to the cost of diverting the rail traffic onto a temporary track during construction. Several TAC attendees discussed whether there is an economic justification to spend the additional money.
- The project team discussed how the design of the culvert or pedestrian options could play out, including a "stepped" cross section in the pedestrian opening which would allow for a raised pathway and reduce the frequency of inundation under the railroad. Eli Cooper mentioned safety/lighting issues through the pedestrian tunnel.
- For the first (March 13, 2013) public meeting, OHM Advisors will prepare schematics for the two options discussed at this meeting, including an illustration of before/after flooding levels (in both plan and cross section views). OHM will prepare a 30-minute formal presentation to cover the key project issues. OHM will submit a draft of the materials to the City for review prior to the public meeting.

SIGN-IN SHEET

Technical Advisory Committee Meeting #2

Date: February 19th, 2013

Time: 2:30-3:30 PM

Location: Larcom City Hall- 301 E Huron Street- Basement Conference Room

Name (Please Print)	Group/Organization
1. Lesley Rivera	City A ² -SPU
2. Murat	OHM
3. Jerry Hancock	City A ² -SPU
4. Troy Baughman	City -SPU
5. Michael Nearing	City of A ² - PMSU
6. Matt Ward	City A ²
7. Eli Cooper	City of Ann Arbor
8. Ron Cavallaro	OHM
9. JEREMY HEDDEN	BERGMANN ASSOCIATES
10. GREG KACZYNSKY	OHM



Name (Please Print)	Group/Organization
11. Amy kuras	
12. Dennis Wojcik	
13.	
14.	
15.	
16.	
17.	
18.	
19.	
20.	
21.	
22.	



Meeting Summary

Allen Creek Berm Study – TAC Meeting #3

May 3, 2013, 9:00 a.m.
City Hall Basement Conference Room
Attendees: See attached sign-in list

Key Discussion Topics

- Greg Kacvinsky summarized the efforts made by the project team between the second and third TAC meetings.
- The group discussed how MDOT's response to a pedestrian viaduct should be documented in this report. The report currently paints a negative picture of MDOT's flexibility. With an upcoming meeting between City and MDOT staff, it was agreed that the final report would be held back until after the City has a chance to confirm MDOT's position.
- The draft Technical Memorandum was discussed in detail. Attendees provided verbal comments on the document, with the highlights listed below:
 - Include a reference to other funding sources, including Brownfields Grants, MDOT / USDOT funding for pedestrian access, Public/Private Partnerships, and more detail on the SAW Grants.
 - Make a clear statement about the need to design the improvements to prevent pedestrian intrusion while maintaining flow capacity (most important for the non-pedestrian alternatives).
 - Increase the proposed wall height to be 1.0 feet above the calculated 100-year high water elevation at the 201 Depot parking lot.
 - Under Key Findings, Item 2, state the recurrence interval storm associated with the full-pipe flow capacity of the Allen Creek enclosure.
 - Change the design storm convention from 100-year, 50-year, etc. to 1%, 2%, etc., respectively.
 - Make a statement regarding groundwater levels and the potential for groundwater contamination for all potential areas for underground utility installation. The City and the WCWRC will provide OHM Advisors with additional information on recent groundwater monitoring activities.
 - Under Key Recommendations, Item 5, re-word the LOMR discussion to eliminate the reference to "regardless of whether the recommended hydraulic improvements are implemented", and assume that the project will be implemented.
 - Peter Allen should be contacted. Jerry Hancock will attempt to arrange a meeting or, at a minimum, to get Mr. Allen's feedback on the draft report.
 - Include a reference to the culvert/bridge length in the description of each alternative.
 - Jeremy Hedden (Bergmann) will contact Mike Nearing about the unit prices used in the cost estimates prior to finalizing the report (and will forward the quotes on the 3-sided culverts).
 - Increase the unit price for the 48-inch Depot Street relief sewer to account for the likelihood of contaminated soils and groundwater.
 - Add a reference to the report explaining the assumption of the use of steel girders (as opposed to pre-stressed box beams).

- **ACTION ITEMS:**

- Jerry Hancock to contact Peter Allen to discuss project alternatives. OHM Advisors can attend if desired.
- City / WCWRC to provide information on groundwater monitoring in the project area [**City staff provided groundwater monitoring report to OHM Advisors on May 4**].
- Jeremy Hedden (Bergmann) to contact Mike Nearing to discuss unit prices and cost estimating strategy.
- OHM Advisors to prepare a revision to the Technical Memorandum (based on the comments at this meeting) for the City to use to present to MDOT.
- City staff to schedule meeting with MDOT to discuss pedestrian access alternatives.
- City staff to provide feedback from MDOT meeting so OHM Advisors can provide final draft of the Technical Memorandum.
- City staff to schedule final public meeting after submittal of the final draft of the Technical Memorandum.

SIGN-IN SHEET

Technical Advisory Committee Meeting #3

Date: May 3, 2013

Time: 9:00 -11:00 AM

Location: Ann Arbor City Hall- 301 E Huron Street- Basement Conference Room A-B

Name (Please Print)	Group/Organization
1. Michael G. Newing	City of A ² - PMSU
2. Trey Baughman	City - SPU
3. CRAIG HUGG	City PSA
4. Eli Cooper	City - SPU
5. JEREMY HEDDEN	BERGMANN ASSOCIATES
6. GREG KACVINSKI	OHM ADVISORS
7. Lesley Rivera	City A ² - SPU
8. Dennis Wojcik	WCWRC
9. Jerry Hancock	City of A ² - SPU
10. Matt Ward	City A ²



Appendix G

Planning-Level Cost Estimates

**Alternative 1
54-inch RCP Culverts (No Pedestrian Access)
Planning-Level Cost Opinions**

Owner: City of Ann Arbor, Michigan
 Project: Allen Creek Berm Opening Study
 Work: Alternative Analysis

Date: 5/22/2013
 Project No. 0028-12-0011
 Prepared By: GPK
 Reviewer: JAH (Bergmann)

Item No.	Item Description	Est. Quantity	Unit	Unit Price	Total Cost
1	Mobilization	1	LS	\$110,000	\$110,000
2	Soil Erosion & Sediment Control	1	LS	\$8,000	\$8,000
3	Remove abandoned railroad abutment and associated steel supports	1	LS	\$30,000	\$30,000
4	Inlet Structure - Reinforced Concrete	150	CYD	\$500	\$75,000
5	Outlet Transition Structure - Reinforced Concrete	150	CYD	\$500	\$75,000
6	Huron River Outlet Structure	1	LS	\$50,000	\$50,000
7	Safety Rails and Grating (all structures)	1	LS	\$50,000	\$50,000
8	54" Class V RCP - Jack and Bore	450	LF	\$1,500	\$675,000
9	Excavation	1,000	CYD	\$7.00	\$7,000
10	Haul-off and dispose of contaminated soil	1,000	CYD	\$20.00	\$20,000
11	4' x 8' Reinforced Concrete Box Culvert	200	LF	\$1,200	\$240,000
12	Restoration and Tree Mitigation (DTE Gas Site)	1	LS	\$10,000	\$10,000
13	Restoration (201 Depot Site)	1	LS	\$10,000	\$10,000
14	8' chain link security fence	730	LF	\$25	\$18,250
15	Railroad flagging	30	DAYS	\$1,250	\$37,500
16	201 Depot - Concrete Curb Removal	160	LF	\$7	\$1,120
17	201 Depot - Concrete Curb Replacement	160	LF	\$20	\$3,200
18	201 Depot - Asphalt Removal and Replacement	650	SYD	\$35	\$22,750
19	48" RCP Depot Street Relief Sewer	275	LF	\$200	\$55,000
20	6' Diam. Storm Manhole	3	EA	\$6,000	\$18,000
21	7' Diam. Storm Manhole (Depot Street)	1	EA	\$10,000	\$10,000
				SUBTOTAL	\$1,526,000
	Contingencies	25%			\$380,000
				SUBTOTAL (w/CONTINGENCIES)	\$1,910,000
	PROJECT COSTS				
	Design and Construction Engineering	15%			\$287,000
	Railroad Preliminary Engineering (Amtrak review/coordination fees)				\$15,000
	TOTAL PLANNING-LEVEL COST OPINION				\$2,210,000
	Total Cost <u>without</u> 48" Depot St. Relief Sewer (for BCR Calculation)				\$2,090,000

Alternative 1a
54-inch RCP Culverts, Open Channel Option (No Pedestrian Access)
Planning-Level Cost Opinions

Owner: City of Ann Arbor, Michigan
Project: Allen Creek Berm Opening Study
Work: Alternative Analysis

Date: 5/22/2013
Project No. 0028-12-0011
Prepared By: GPK
Reviewer: JAH (Bergmann)

Item No.	Item Description	Est. Quantity	Unit	Unit Price	Total Cost
1	Mobilization	1	LS	\$100,000	\$100,000
2	Soil Erosion & Sediment Control	1	LS	\$8,000	\$8,000
3	Remove abandoned railroad abutment and associated steel supports	1	LS	\$30,000	\$30,000
4	Inlet Structure - Reinforced Concrete	150	CYD	\$500	\$75,000
5	Outlet Structure w/Baffles	100	CYD	\$500	\$50,000
6	Safety Rails and Grating (all structures)	1	LS	\$40,000	\$40,000
7	54" Class V RCP - Jack and Bore	450	LF	\$1,500	\$675,000
8	Excavation for outlet channel	2,500	CYD	\$7.00	\$17,500
9	18-inch compacted clay liner	1,500	SYD	\$10.00	\$15,000
10	Topsoil, finish grading and restoration - outlet channel	1,500	SYD	\$15.00	\$22,500
11	Haul-off and dispose of contaminated soil	2,500	CYD	\$20.00	\$50,000
12	Restoration and Tree Mitigation (DTE Gas Site)	1	LS	\$14,000	\$14,000
13	Restoration (201 Depot Site)	1	LS	\$10,000	\$10,000
14	8' chain link security fence	730	LF	\$25	\$18,250
15	Railroad flagging	30	DAYS	\$1,250	\$37,500
16	201 Depot - Concrete Curb Removal	160	LF	\$7	\$1,120
17	201 Depot - Concrete Curb Replacement	160	LF	\$20	\$3,200
18	201 Depot - Asphalt Removal and Replacement	650	SYD	\$35	\$22,750
19	48" RCP Depot Street Relief Sewer	275	LF	\$200	\$55,000
20	6' Diam. Storm Manhole	3	EA	\$6,000	\$18,000
21	7' Diam. Storm Manhole (Depot Street)	1	EA	\$10,000	\$10,000
				SUBTOTAL	\$1,273,000
	Contingencies	25%			\$320,000
				SUBTOTAL (w/CONTINGENCIES)	\$1,600,000
	PROJECT COSTS				
	Design and Construction Engineering	15%			\$240,000
	Railroad Preliminary Engineering (Amtrak review/coordination fees)				\$15,000
TOTAL PLANNING-LEVEL COST OPINION					\$1,860,000
Total Cost <u>without</u> 48" Depot St. Relief Sewer (for BCR Calculation)					\$1,730,000

Alternative 2
At-Grade 48-inch RCP Culverts (No Pedestrian Access)
Planning-Level Cost Opinions

Owner: City of Ann Arbor, Michigan
Project: Allen Creek Berm Opening Study
Work: Alternative Analysis

Date: 5/22/2013
Project No. 0028-12-0011
Prepared By: GPK
Reviewer: JAH (Bergmann)

Item No.	Item Description	Est. Quantity	Unit	Unit Price	Total Cost
1	Mobilization	1	LS	\$120,000	\$120,000
2	Soil Erosion & Sediment Control	1	LS	\$10,000	\$10,000
3	Remove existing retaining wall along north side of 201 Depot parking lot	270	LF	\$75	\$20,250
4	Outlet Transition Structure - Reinforced Concrete	200	CYD	\$500	\$100,000
5	Huron River Outlet Structure	1	LS	\$50,000	\$50,000
6	Safety Rails and Grating (all structures)	1	LS	\$35,000	\$35,000
7	48" Class V RCP - Jack and Bore	630	LF	\$1,300	\$819,000
8	Excavation	2,000	CYD	\$7.00	\$14,000
9	Haul-off and dispose of contaminated soil	2,000	CYD	\$20.00	\$40,000
10	4' x 8' Reinforced Concrete Box Culvert	320	LF	\$1,200	\$384,000
11	Restoration and Tree Mitigation (DTE Gas Site)	1	LS	\$12,000	\$12,000
12	Restoration (201 Depot Site)	1	LS	\$10,000	\$10,000
13	8' chain link security fence	730	LF	\$25	\$18,250
14	Railroad flagging	35	DAYS	\$1,250	\$43,750
15	201 Depot - Concrete Curb Removal	140	LF	\$7	\$980
16	201 Depot - Concrete Curb Replacement	140	LF	\$20	\$2,800
17	201 Depot - Asphalt Removal and Replacement	600	SYD	\$35	\$21,000
18	48" RCP Depot Street Relief Sewer	275	LF	\$200	\$55,000
19	6' Diam. Storm Manhole	3	EA	\$6,000	\$18,000
20	7' Diam. Storm Manhole (Depot Street)	1	EA	\$10,000	\$10,000
				SUBTOTAL	\$1,785,000
	Contingencies	25%			\$450,000
				SUBTOTAL (w/CONTINGENCIES)	\$2,240,000
	PROJECT COSTS				
	Design and Construction Engineering	15%			\$336,000
	Railroad Preliminary Engineering (Amtrak review/coordination fees)				\$15,000
	TOTAL PLANNING-LEVEL COST OPINION				\$2,590,000
	Total Cost <u>without</u> 48" Depot St. Relief Sewer (for BCR Calculation)				\$2,460,000

Alternative 2a
At-Grade 48-inch RCP Culverts, Open Channel Option (No Pedestrian Access)
Planning-Level Cost Opinions

Owner: City of Ann Arbor, Michigan
Project: Allen Creek Berm Opening Study
Work: Alternative Analysis

Date: 5/22/2013
Project No. 0028-12-0011
Prepared By: GPK
Reviewer: JAH (Bergmann)

Item No.	Item Description	Est. Quantity	Unit	Unit Price	Total Cost
1	Mobilization	1	LS	\$100,000	\$100,000
2	Soil Erosion & Sediment Control	1	LS	\$10,000	\$10,000
3	Remove existing retaining wall along north side of 201 Depot parking lot	270	LF	\$75	\$20,250
4	Outlet Structure w/Baffles	125	CYD	\$500	\$62,500
5	Safety Rails and Grating (all structures)	1	LS	\$25,000	\$25,000
6	48" Class V RCP - Jack and Bore	630	LF	\$1,300	\$819,000
7	Excavation for outlet channel	5,000	CYD	\$7.00	\$35,000
8	18-inch compacted clay liner	3,000	SYD	\$10.00	\$30,000
9	Topsoil, finish grading and restoration - outlet channel	3,000	SYD	\$15.00	\$45,000
10	Haul-off and dispose of contaminated soil	5,000	CYD	\$20.00	\$100,000
11	Restoration and Tree Mitigation (DTE Gas Site)	1	LS	\$15,000	\$15,000
12	Restoration (201 Depot Site)	1	LS	\$10,000	\$10,000
13	8' chain link security fence	730	LF	\$25	\$18,250
14	Railroad flagging	35	DAYS	\$1,250	\$43,750
15	201 Depot - Concrete Curb Removal	140	LF	\$7	\$980
16	201 Depot - Concrete Curb Replacement	140	LF	\$20	\$2,800
17	201 Depot - Asphalt Removal and Replacement	600	SYD	\$35	\$21,000
18	48" RCP Depot Street Relief Sewer	275	LF	\$200	\$55,000
19	6' Diam. Storm Manhole	3	EA	\$6,000	\$18,000
20	7' Diam. Storm Manhole (Depot Street)	1	EA	\$10,000	\$10,000
				SUBTOTAL	\$1,442,000
	Contingencies	25%			\$360,000
				SUBTOTAL (w/CONTINGENCIES)	\$1,810,000
	PROJECT COSTS				
	Design and Construction Engineering	15%			\$272,000
	Railroad Preliminary Engineering (Amtrak review/coordination fees)				\$15,000
TOTAL PLANNING-LEVEL COST OPINION					\$2,100,000
Total Cost <u>without</u> 48" Depot St. Relief Sewer (for BCR Calculation)					\$1,970,000

**Alternative 3
Flood Control Culvert w/Pedestrian Access
Planning-Level Cost Opinions**

Owner: City of Ann Arbor, Michigan
 Project: Allen Creek Berm Opening Study
 Work: Alternative Analysis

Date: 5/22/2013
 Project No. 0028-12-0011
 Prepared By: GPK
 Reviewer: JAH (Bergmann)

Item No.	Item Description	Est. Quantity	Unit	Unit Price	Total Cost
1	Mobilization	1	LS	\$125,000	\$125,000
2	Soil Erosion & Sediment Control	1	LS	\$15,000	\$15,000
3	Remove existing retaining wall along north side of 201 Depot parking lot	270	LF	\$50	\$13,500
4	Bike/Ped Sidewalk and Ramp (south side of railroad to 5th/Depot int.)	6,200	SF	\$6	\$37,200
5	Retaining walls and flood wall to accommodate bike/ped path	200	CYD	\$500	\$100,000
6	Inlet Structure for flood conveyance culvert - Reinforced Concrete	100	CYD	\$500	\$50,000
7	8' decorative security fence (b/w sidewalk and railroad)	580	LF	\$75	\$43,500
8	Safety Rails and Grating (all structures)	1	LS	\$50,000	\$50,000
9	Structural Backfill for Culverts	1,600	CYD	\$14	\$22,400
10	Excavation for Culvert Foundation	3,000	CYD	\$9	\$27,000
11	Pre-cast 3-sided culvert, 20' x 8'	60	LF	\$1,400	\$84,000
12	Pre-cast 3-sided culvert, 14' x 11'	60	LF	\$1,100	\$66,000
13	Steel Sheet Piling, Temporary	1,320	SF	\$60	\$79,200
14	Pile, CIP Concrete, Furnished and Driven, 16-inch	3,600	LF	\$60	\$216,000
15	Substructure, Concrete	90	CYD	\$450	\$40,500
16	Temporary Shoofly, including embankment	1,770	LF	\$250	\$442,500
17	Temporary Shoofly Bridge over Allen Creek Outlet	1	LS	\$150,000	\$150,000
18	Railroad Track Work	280	LF	\$220	\$61,600
19	Fiber Optic Relocation (assume two moves)	1	LS	\$400,000	\$400,000
20	Security Lighting for Pedestrian Underpass	1	LS	\$25,000	\$25,000
21	Trench Drain and Outlet for Pedestrian Underpass	1	LS	\$15,000	\$15,000
22	Excavation for outlet channel	5,000	CYD	\$7.00	\$35,000
23	18-inch compacted clay liner	3,000	SYD	\$10.00	\$30,000
24	Topsoil, finish grading and restoration - outlet channel	3,000	SYD	\$15.00	\$45,000
25	Haul-off and dispose of contaminated soil	5,000	CYD	\$20.00	\$100,000
26	Restoration and Tree Mitigation (DTE Gas Site)	1	LS	\$15,000	\$15,000
27	Restoration (201 Depot Site)	1	LS	\$10,000	\$10,000
28	8' chain link security fence (north side of railroad)	730	LF	\$25	\$18,250
29	Railroad flagging	144	DAYS	\$1,250	\$180,000
30	201 Depot - Concrete Curb Removal	160	LF	\$7	\$1,120
31	201 Depot - Concrete Curb Replacement	160	LF	\$20	\$3,200
32	201 Depot - Asphalt Removal and Replacement	650	SYD	\$35	\$22,750
33	48" RCP Depot Street Relief Sewer	285	LF	\$200	\$57,000
34	6' Diam. Storm Manhole	1	EA	\$6,000	\$6,000
35	7' Diam. Storm Manhole (Depot Street and parking lot)	2	EA	\$10,000	\$20,000
				SUBTOTAL	\$2,607,000
	Contingencies	25%			\$650,000
				SUBTOTAL (w/CONTINGENCIES)	\$3,260,000
	PROJECT COSTS				
	Design and Construction Engineering	15%			\$489,000
	Railroad Preliminary Engineering (Amtrak review/coordination fees)				\$50,000
	Rail Communication Line Relocation				\$60,000
	TOTAL PLANNING-LEVEL COST OPINION				\$3,860,000
	Total Cost <i>without</i> 48" Depot St. Relief Sewer (for BCR Calculation)				\$3,740,000

Alternative 4
Trestle Bridge Option - Flood Control w/Pedestrian Access
Planning-Level Cost Opinions

Owner: City of Ann Arbor, Michigan
Project: Allen Creek Berm Opening Study
Work: Alternative Analysis

Date: 5/22/2013
Project No. 0028-12-0011
Prepared By: GPK
Reviewer: JAH (Bergmann)

Item No.	Item Description	Est. Quantity	Unit	Unit Price	Total Cost
1	Mobilization	1	LS	\$175,000	\$175,000
2	Soil Erosion & Sediment Control	1	LS	\$15,000	\$15,000
3	Remove existing retaining wall along north side of 201 Depot parking lot	300	LF	\$50	\$15,000
4	Bike/Ped Sidewalk and Ramp (south side of railroad to 5th/Depot int.)	6,200	SF	\$6	\$37,200
5	Retaining walls and flood wall to accommodate bike/ped path	200	CYD	\$500	\$100,000
6	Retaining wall/weir upstream of trestle bridge	120	CYD	\$500	\$60,000
7	Flood protection wall (path isolation) downstream of bridge	50	CYD	\$500	\$25,000
8	8' decorative security fence (b/w sidewalk and railroad)	580	LF	\$75	\$43,500
9	Structural Backfill for Bridge	700	CYD	\$14	\$9,800
10	Excavation for Bridge Foundation	3,000	CYD	\$9	\$27,000
11	Steel Sheet Piling, Temporary	1,320	SF	\$60	\$79,200
12	Pile, CIP Concrete, Furnished and Driven, 16-inch	2,700	LF	\$60	\$162,000
13	Substructure, Concrete	230	CYD	\$450	\$103,500
14	Superstructure, Concrete	152	CYD	\$500	\$76,000
15	Structural Steel, Mixed, Erect	355,000	LB	\$2.25	\$798,750
16	Temporary Shoofly, including embankment	1,800	LF	\$250	\$450,000
17	Temporary Shoofly Bridge over Allen Creek Outlet	1	LS	\$150,000	\$150,000
18	Railroad Track Work	295	LF	\$220	\$64,900
19	Fiber Optic Relocation (assume two moves)	1	LS	\$400,000	\$400,000
20	Security Lighting for Pedestrian Underpass	1	LS	\$25,000	\$25,000
21	Excavation for outlet channel	5,000	CYD	\$7.00	\$35,000
22	18-inch compacted clay liner	3,000	SYD	\$10.00	\$30,000
23	Topsoil, finish grading and restoration - outlet channel	3,000	SYD	\$15.00	\$45,000
24	Haul-off and dispose of contaminated soil	5,000	CYD	\$20.00	\$100,000
25	Restoration and Tree Mitigation (DTE Gas Site)	1	LS	\$15,000	\$15,000
26	Restoration (201 Depot Site)	1	LS	\$10,000	\$10,000
27	8' chain link security fence (north side of railroad)	730	LF	\$25	\$18,250
28	Railroad flagging	144	DAYS	\$1,250	\$180,000
29	201 Depot - Concrete Curb Removal	160	LF	\$7	\$1,120
30	201 Depot - Concrete Curb Replacement	160	LF	\$20	\$3,200
31	201 Depot - Asphalt Removal and Replacement	650	SYD	\$35	\$22,750
32	48" RCP Depot Street Relief Sewer	285	LF	\$200	\$57,000
33	6' Diam. Storm Manhole	1	EA	\$6,000	\$6,000
34	7' Diam. Storm Manhole (Depot Street and parking lot)	2	EA	\$10,000	\$20,000
				SUBTOTAL	\$3,361,000
	Contingencies	25%			\$840,000
				SUBTOTAL (w/CONTINGENCIES)	\$4,210,000
	PROJECT COSTS				
	Design and Construction Engineering	15%			\$632,000
	Railroad Preliminary Engineering (Amtrak review/coordination fees)				\$50,000
	Rail Communication Line Relocation				\$60,000
	TOTAL PLANNING-LEVEL COST OPINION				\$4,950,000
	Total Cost <i>without</i> 48" Depot St. Relief Sewer (for BCR Calculation)				\$4,820,000

Preferred Alternative
Flood Control Culvert w/Pedestrian Access
Planning-Level Cost Opinions

Owner: City of Ann Arbor, Michigan
Project: Allen Creek Berm Opening Study
Work: Alternative Analysis

Date: 10/18/2013
Project No. 0028-12-0011
Prepared By: GPK
Reviewer: JAH (Bergmann)

Item No.	Item Description	Est. Quantity	Unit	Unit Price	Costs Attributable to Flood Control	Costs NOT Attributable to Flood Control
1	Mobilization	1	LS	\$125,000	\$93,750	\$31,250
2	Soil Erosion & Sediment Control	1	LS	\$15,000	\$11,250	\$3,750
3	Remove existing retaining wall along north side of 201 Depot parking lot	270	LF	\$50	\$13,500	\$0
4	Remove abandoned railroad abutment and associated steel supports	1	LS	\$40,000	\$0	\$40,000
5	Bike/Ped Sidewalk and Ramp (south side of railroad to N. Main)	3,300	SF	\$6	\$0	\$19,800
6	Retaining walls and flood wall to accommodate bike/ped path	220	CYD	\$500	\$0	\$110,000
7	Inlet Structure for flood conveyance culvert - Reinforced Concrete	100	CYD	\$500	\$50,000	\$0
8	8' decorative security fence (b/w sidewalk and railroad)	580	LF	\$75	\$0	\$43,500
9	Safety Rails and Grating (all structures)	1	LS	\$50,000	\$25,000	\$25,000
10	Structural Backfill for Culverts	1,600	CYD	\$14	\$14,941	\$7,459
11	Excavation for Culvert Foundation	3,000	CYD	\$9	\$18,009	\$8,991
12	Pre-cast 3-sided culvert, 20' x 8'	60	LF	\$1,400	\$84,000	\$0
13	Pre-cast 3-sided culvert, 14' x 11'	60	LF	\$1,100	\$0	\$66,000
14	Steel Sheet Piling, Temporary	1,320	SF	\$60	\$52,826	\$26,374
15	Pile, CIP Concrete, Furnished and Driven, 16-inch	3,600	LF	\$60	\$144,072	\$71,928
16	Substructure, Concrete	90	CYD	\$450	\$27,014	\$13,487
17	Temporary Shoofly, including embankment	1,770	LF	\$250	\$442,500	\$0
18	Temporary Shoofly Bridge over Allen Creek Outlet	1	LS	\$150,000	\$150,000	\$0
19	Railroad Track Work	280	LF	\$220	\$61,600	\$0
20	Fiber Optic Relocation (assume two moves)	1	LS	\$400,000	\$400,000	\$0
21	Security Lighting for Pedestrian Underpass	1	LS	\$25,000	\$0	\$25,000
22	Trench Drain and Outlet for Pedestrian Underpass	1	LS	\$15,000	\$0	\$15,000
23	Excavation for outlet channel	5,000	CYD	\$7.00	\$35,000	\$0
24	18-inch compacted clay liner	3,000	SYD	\$10.00	\$30,000	\$0
25	Topsoil, finish grading and restoration - outlet channel	3,000	SYD	\$15.00	\$45,000	\$0
26	Haul-off and dispose of contaminated soil	5,000	CYD	\$20.00	\$100,000	\$0
27	Restoration and Tree Mitigation (DTE Gas Site)	1	LS	\$15,000	\$15,000	\$0
28	Restoration (201 Depot Site)	1	LS	\$10,000	\$5,000	\$5,000
29	8' chain link security fence (north side of railroad)	1,600	LF	\$25	\$20,000	\$20,000
30	Railroad flagging	144	DAYS	\$1,250	\$180,000	\$0
31	201 Depot - Concrete Curb Removal	160	LF	\$7	\$1,120	\$0
32	201 Depot - Concrete Curb Replacement	160	LF	\$20	\$3,200	\$0
33	201 Depot - Asphalt Removal and Replacement	650	SYD	\$35	\$11,375	\$11,375
34	48" RCP Depot Street Relief Sewer	285	LF	\$200	\$0	\$57,000
35	6' Diam. Storm Manhole	1	EA	\$6,000	\$0	\$6,000
36	7' Diam. Storm Manhole (Depot Street and parking lot)	2	EA	\$10,000	\$0	\$20,000
37	Property/Easement Acquisition (assume \$25,000 / parking spot lost)	10	EA	\$25,000	\$0	\$250,000
				SUBTOTAL	\$2,035,000	\$877,000
	Contingencies	25%			\$510,000	\$220,000
				SUBTOTAL (w/CONTINGENCIES)	\$2,550,000	\$1,100,000
	PROJECT COSTS					
	Design and Construction Engineering	15%			\$383,000	\$165,000
	Railroad Preliminary Engineering (Amtrak review/coordination fees)				\$50,000	\$0
	Rail Communication Line Relocation				\$60,000	\$0
	TOTAL PLANNING-LEVEL COST OPINION (FLOOD CONTROL COMPONENTS ONLY)				\$3,040,000	
	TOTAL PLANNING-LEVEL COST OPINION (COSTS NOT ATTRIBUTABLE TO FLOOD CONTROL)					\$1,265,000
	TOTAL PLANNING-LEVEL COST OPINION (TOTAL PROJECT)					\$4,305,000

**ATTACHMENT B
LEGAL STATUS OF RESPONDENT**

(The Respondent shall fill out the provision and strike out the remaining ones.)

The Respondent is:

- A corporation organized and doing business under the laws of the state of _____, for whom _____ bearing the office title of _____, whose signature is affixed to this proposal, is authorized to execute contracts on behalf of respondent.*

*If not incorporated in Michigan, please attach the corporation's Certificate of Authority

- A limited liability company doing business under the laws of the State of _____, whom _____ bearing the title of _____ whose signature is affixed to this proposal, is authorized to execute contract on behalf of the LLC.
- A partnership organized under the laws of the State of _____ and filed with the County of _____, whose members are (attach list including street and mailing address for each.)
- An individual, whose signature with address, is affixed to this RFP.

Respondent has examined the basic requirements of this RFP and its scope of services, including all Addendum (if applicable) and hereby agrees to offer the services as specified in the RFP.

Signature

Date: _____,

(Print) Name _____ Title _____

Firm: _____

Address: _____

Contact Phone _____

Fax _____

Email _____

**ATTACHMENT D
CITY OF ANN ARBOR
LIVING WAGE ORDINANCE DECLARATION OF COMPLIANCE**

The Ann Arbor Living Wage Ordinance (Section 1:811-1:821 of Chapter 23 of Title I of the Code) requires that an employer who is (a) a contractor providing services to or for the City for a value greater than \$10,000 for any twelve-month contract term, or (b) a recipient of federal, state, or local grant funding administered by the City for a value greater than \$10,000, or (c) a recipient of financial assistance awarded by the City for a value greater than \$10,000, shall pay its employees a prescribed minimum level of compensation (i.e., Living Wage) for the time those employees perform work on the contract or in connection with the grant or financial assistance. The Living Wage must be paid to these employees for the length of the contract/program.

Companies employing fewer than 5 persons and non-profits employing fewer than 10 persons are exempt from compliance with the Living Wage Ordinance. If this exemption applies to your company/non-profit agency please check here [] No. of employees ____

The Contractor or Grantee agrees:

- (a) To pay each of its employees whose wage level is not required to comply with federal, state or local prevailing wage law, for work covered or funded by a contract with or grant from the City, no less than the Living Wage. The current Living Wage is defined as \$12.93/hour for those employers that provide employee health care (as defined in the Ordinance at Section 1:815 Sec. 1 (a)), or no less than \$14.43/hour for those employers that do not provide health care. The Contractor or Grantor understands that the Living Wage is adjusted and established annually on April 30 in accordance with the Ordinance and covered employers shall be required to pay the adjusted amount thereafter to be in compliance (Section 1:815(3)).

Check the applicable box below which applies to your workforce

- [] Employees who are assigned to any covered City contract/grant will be paid at or above the applicable living wage without health benefits
- [] Employees who are assigned to any covered City contract/grant will be paid at or above the applicable living wage with health benefits
- (b) To post a notice approved by the City regarding the applicability of the Living Wage Ordinance in every work place or other location in which employees or other persons contracting for employment are working.
- (c) To provide to the City payroll records or other documentation within ten (10) business days from the receipt of a request by the City.
- (d) To permit access to work sites to City representatives for the purposes of monitoring compliance, and investigating complaints or non-compliance.
- (e) To take no action that would reduce the compensation, wages, fringe benefits, or leave available to any employee covered by the Living Wage Ordinance or any person contracted for employment and covered by the Living Wage Ordinance in order to pay the living wage required by the Living Wage Ordinance.

The undersigned states that he/she has the requisite authority to act on behalf of his/her employer in these matters and has offered to provide the services or agrees to accept financial assistance in accordance with the terms of the Living Wage Ordinance. The undersigned certifies that he/she has read and is familiar with the terms of the Living Wage Ordinance, obligates the Employer/Grantee to those terms and acknowledges that if his/her employer is found to be in violation of Ordinance it may be subject to civil penalties and termination of the awarded contract or grant of financial assistance.

Company Name

Signature of Authorized Representative

Date

Print Name and Title

Address, City, State, Zip

Phone/Email address

Questions about this form? Contact Procurement Office City of Ann Arbor Phone: 734/794-6500
Revised 2/17/16 Rev 0

LW-2



ATTACHMENT E

VENDOR CONFLICT OF INTEREST DISCLOSURE FORM
--

All vendors interested in conducting business with the City of Ann Arbor must complete and return the Vendor Conflict of Interest Disclosure Form in order to be eligible to be awarded a contract. Please note that all vendors are subject to comply with the City of Ann Arbor's conflict of interest policies as stated within the certification section below.

If a vendor has a relationship with a City of Ann Arbor official or employee, an immediate family member of a City of Ann Arbor official or employee, the vendor shall disclose the information required below.

1. No City official or employee or City employee's immediate family member has an ownership interest in vendor's company or is deriving personal financial gain from this contract.
2. No retired or separated City official or employee who has been retired or separated from the City for less than one (1) year has an ownership interest in vendor's Company.
3. No City employee is contemporaneously employed or prospectively to be employed with the vendor.
4. Vendor hereby declares it has not and will not provide gifts or hospitality of any dollar value or any other gratuities to any City employee or elected official to obtain or maintain a contract.
5. Please note any exceptions below:

Conflict of Interest Disclosure*	
Name of City of Ann Arbor employees, elected officials or immediate family members with whom there may be a potential conflict of interest.	<input type="checkbox"/> Relationship to employee <hr style="border: 0; border-top: 1px solid black;"/> <input type="checkbox"/> Interest in vendor's company <input type="checkbox"/> Other (please describe in box below)

*Disclosing a potential conflict of interest does not disqualify vendors. In the event vendors do not disclose potential conflicts of interest and they are detected by the City, vendor will be exempt from doing business with the City.

I certify that this Conflict of Interest Disclosure has been examined by me and that its contents are true and correct to my knowledge and belief and I have the authority to so certify on behalf of the Vendor by my signature below:		
Vendor Name	Vendor Phone Number	
Signature of Vendor Authorized Representative	Date	Printed Name of Vendor Authorized Representative

ATTACHMENT F
CITY OF ANN ARBOR NON-DISCRIMINATION ORDINANCE

Relevant provisions of Chapter 112, Nondiscrimination, of the Ann Arbor City Code are included below. You can review the entire ordinance at www.a2gov.org/departments/city-clerk

Intent: It is the intent of the city that no individual be denied equal protection of the laws; nor shall any individual be denied the enjoyment of his or her civil or political rights or be discriminated against because of actual or perceived age, arrest record, color, disability, educational association, familial status, family responsibilities, gender expression, gender identity, genetic information, height, HIV status, marital status, national origin, political beliefs, race, religion, sex, sexual orientation, source of income, veteran status, victim of domestic violence or stalking, or weight.

Discriminatory Employment Practices: No person shall discriminate in the hire, employment, compensation, work classifications, conditions or terms, promotion or demotion, or termination of employment of any individual. No person shall discriminate in limiting membership, conditions of membership or termination of membership in any labor union or apprenticeship program.

Discriminatory Effects: No person shall adopt, enforce or employ any policy or requirement which has the effect of creating unequal opportunities according to actual or perceived age, arrest record, color, disability, educational association, familial status, family responsibilities, gender expression, gender identity, genetic information, height, HIV status, marital status, national origin, political beliefs, race, religion, sex, sexual orientation, source of income, veteran status, victim of domestic violence or stalking, or weight for an individual to obtain housing, employment or public accommodation, except for a bona fide business necessity. Such a necessity does not arise due to a mere inconvenience or because of suspected objection to such a person by neighbors, customers or other persons.

Nondiscrimination by City Contractors: All contractors proposing to do business with the City of Ann Arbor shall satisfy the contract compliance administrative policy adopted by the City Administrator in accordance with the guidelines of this section. All city contractors shall ensure that applicants are employed and that employees are treated during employment in a manner which provides equal employment opportunity and tends to eliminate inequality based upon any classification protected by this chapter. All contractors shall agree not to discriminate against an employee or applicant for employment with respect to hire, tenure, terms, conditions, or privileges of employment, or a matter directly or indirectly related to employment, because of any applicable protected classification. All contractors shall be required to post a copy of Ann Arbor's Non-Discrimination Ordinance at all work locations where its employees provide services under a contract with the city.

Complaint Procedure: If any individual has a grievance alleging a violation of this chapter, he/she has 180 calendar days from the date of the individual's knowledge of the allegedly discriminatory action or 180 calendar days from the date when the individual should have known of the alleged discriminatory action to file a complaint with the city's Human Rights Commission. If an individual fails to file a complaint alleging a violation of this chapter within the specified time frame, the complaint will not be considered by the Human Rights Commission. The complaint should be made in writing to the Human Rights Commission. The complaint may be filed in person with the City Clerk, by e-mail (hrc@a2gov.org), by phone (734-794-6141) or by mail (Ann Arbor Human Rights Commission, PO Box 8647, Ann Arbor, MI 48107). The complaint must contain information about the alleged discrimination, such as name, address, phone number of the complainant and location, date and description of the alleged violation of this chapter.

Private Actions For Damages or Injunctive Relief: To the extent allowed by law, an individual who is the victim of discriminatory action in violation of this chapter may bring a civil action for appropriate injunctive relief or damages or both against the person(s) who acted in violation of this chapter.

ATTACHMENT G

CITY OF ANN ARBOR LIVING WAGE ORDINANCE

RATE EFFECTIVE APRIL 30, 2016 - ENDING APRIL 29, 2017

\$12.93 per hour

If the employer provides health care benefits*

\$14.43 per hour

If the employer does **NOT** provide health care benefits*

Employers providing services to or for the City of Ann Arbor or recipients of grants or financial assistance from the City of Ann Arbor for a value of more than \$10,000 in a twelve-month period of time must pay those employees performing work on a City of Ann Arbor contract or grant, the above living wage.

ENFORCEMENT

The City of Ann Arbor may recover back wages either administratively or through court action for the employees that have been underpaid in violation of the law. Persons denied payment of the living wage have the right to bring a civil action for damages in addition to any action taken by the City.

Violation of this Ordinance is punishable by fines of not more than \$500/violation plus costs, with each day being considered a separate violation. Additionally, the City of Ann Arbor has the right to modify, terminate, cancel or suspend a contract in the event of a violation of the Ordinance.

* Health Care benefits include those paid for by the employer or making an employer contribution toward the purchase of health care. The employee contribution must not exceed \$.50 an hour for an average work week; and the employer cost or contribution must equal no less than \$1/hr for the average work week.

The Law Requires Employers to Display This Poster Where Employees Can Readily See It.

**For Additional Information or to File a Complaint Contact
Colin Spencer at 734/794-6500 or cspencer@a2gov.org**

APPENDIX A: SAMPLE PROFESSIONAL SERVICES AGREEMENT

If a contract is awarded, the selected Firm(s) will be required to adhere to a set of general contract provisions which will become a part of any formal agreement. These provisions are general principles which apply to all contractors/service providers to the City of Ann Arbor. The required provisions are:

SAMPLE PROFESSIONAL SERVICES AGREEMENT BETWEEN

AND THE CITY OF ANN ARBOR
FOR _____

The City of Ann Arbor, a Michigan municipal corporation, having its offices at 301 E. Huron St. Ann Arbor, Michigan 48103 ("City"), and _____

("Contractor") a(n) _____
(State where organized) (Partnership, Sole Proprietorship, or Corporation)

with its address at _____
agree as follows on this _____ day of _____, 20____.

The Contractor agrees to provide services to the City under the following terms and conditions:

I. DEFINITIONS

Administering Service Area/Unit means _____.

Contract Administrator means _____, acting personally or through any assistants authorized by the Administrator/Manager of the Administering Service Area/Unit.

Deliverables means all Plans, Specifications, Reports, Recommendations, and other materials developed for and delivered to City by Contractor under this Agreement

Project means _____
Project name

II. DURATION

This Agreement shall become effective on _____, 20____, and shall remain in effect until satisfactory completion of the Services specified below unless terminated as provided for in Article XI.

III. SERVICES

A. The Contractor agrees to provide _____
type of service

("Services") in connection with the Project as described in Exhibit A. The City retains the right to make changes to the quantities of service within the general scope of the Agreement at any

time by a written order. If the changes add to or deduct from the extent of the services, the contract sum shall be adjusted accordingly. All such changes shall be executed under the conditions of the original Agreement.

- B. Quality of Services under this Agreement shall be of the level of quality performed by persons regularly rendering this type of service. Determination of acceptable quality shall be made solely by the Contract Administrator.
- C. The Contractor shall perform its Services for the Project in compliance with all statutory, regulatory and contractual requirements now or hereafter in effect as may be applicable to the rights and obligations set forth in the Agreement.
- D. The Contractor may rely upon the accuracy of reports and surveys provided to it by the City (if any) except when defects should have been apparent to a reasonably competent professional or when it has actual notice of any defects in the reports and surveys.

IV. INDEPENDENT CONTRACTOR

The Parties agree that at all times and for all purposes under the terms of this Agreement each Party's relationship to any other Party shall be that of an independent contractor. Each Party will be solely responsible for the acts of its own employees, agents, and servants. No liability, right, or benefit arising out of any employer/employee relationship, either express or implied, shall arise or accrue to any Party as a result of this Agreement.

V. COMPENSATION OF CONTRACTOR

- A. The Contractor shall be paid in the manner set forth in Exhibit B. Payment shall be made monthly, unless another payment term is specified in Exhibit B, following receipt of invoices submitted by the Contractor, and approved by the Contract Administrator.
- B. The Contractor will be compensated for Services performed in addition to the Services described in Section III, only when the scope of and compensation for those additional Services have received prior written approval of the Contract Administrator.
- C. The Contractor shall keep complete records of work performed (e.g. tasks performed/hours allocated) so that the City may verify invoices submitted by the Contractor. Such records shall be made available to the City upon request and submitted in summary form with each invoice.

VI. INSURANCE/INDEMNIFICATION

- A. The Contractor shall procure and maintain during the life of this contract such insurance policies, including those set forth in Exhibit C, as will protect itself and the City from all claims for bodily injuries, death or property damage which may

arise under this contract; whether the act(s) or omission(s) giving rise to the claim were made by the Contractor, any subcontractor or anyone employed by them directly or indirectly. In the case of all contracts involving on-site work, the Contractor shall provide to the City, before the commencement of any work under this contract, documentation satisfactory to the City demonstrating it has obtained the policies and endorsements required by Exhibit C.

- B. Any insurance provider of Contractor shall be admitted and authorized to do business in the State of Michigan and shall carry and maintain a minimum rating assigned by A.M. Best & Company's Key Rating Guide of "A-" Overall and a minimum Financial Size Category of "V". Insurance policies and certificates issued by non-admitted insurance companies are not acceptable unless approved in writing by the City.
- C. To the fullest extent permitted by law, Contractor shall indemnify, defend and hold the City, its officers, employees and agents harmless from all suits, claims, judgments and expenses, including attorney's fees, resulting or alleged to result, from any acts or omissions by Contractor or its employees and agents occurring in the performance of or breach in this Agreement, except to the extent that any suit, claim, judgment or expense are finally judicially determined to have resulted from the City's negligence or willful misconduct or its failure to comply with any of its material obligations set forth in this Agreement.

VII. COMPLIANCE REQUIREMENTS

- A. Nondiscrimination. The Contractor agrees to comply, and to require its subcontractor(s) to comply, with the nondiscrimination provisions of MCL 37.2209. The Contractor further agrees to comply with the provisions of Section 9:158 of Chapter 112 of the Ann Arbor City Code and to assure that applicants are employed and that employees are treated during employment in a manner which provides equal employment opportunity.
- B. Living Wage. If the Contractor is a "covered employer" as defined in Chapter 23 of the Ann Arbor City Code, the Contractor agrees to comply with the living wage provisions of Chapter 23 of the Ann Arbor City Code. The Contractor agrees to pay those employees providing Services to the City under this Agreement a "living wage," as defined in Section 1:815 of the Ann Arbor City Code, as adjusted in accordance with Section 1:815(3); to post a notice approved by the City of the applicability of Chapter 23 in every location in which regular or contract employees providing services under this Agreement are working; to maintain records of compliance; if requested by the City, to provide documentation to verify compliance; to take no action that would reduce the compensation, wages, fringe benefits, or leave available to any employee or person contracted for employment in order to pay the living wage required by Section 1:815; and otherwise to comply with the requirements of Chapter 23.

VIII. WARRANTIES BY THE CONTRACTOR

- A. The Contractor warrants that the quality of its Services under this Agreement shall conform to the level of quality performed by persons regularly rendering this type of service.
- B. The Contractor warrants that it has all the skills, experience, and professional licenses necessary to perform the Services specified in this Agreement.
- C. The Contractor warrants that it has available, or will engage, at its own expense, sufficient trained employees to provide the Services specified in this Agreement.
- D. The Contractor warrants that it is not, and shall not become overdue or in default to the City for any contract, debt, or any other obligation to the City including real and personal property taxes.
- E. The Contractor warrants that its proposal for services was made in good faith, it arrived at the costs of its proposal independently, without consultation, communication or agreement, for the purpose of restricting completion as to any matter relating to such fees with any competitor for these Services; and no attempt has been made or shall be made by the Contractor to induce any other perform or firm to submit or not to submit a proposal for the purpose of restricting competition.

IX. OBLIGATIONS OF THE CITY

- A. The City agrees to give the Contractor access to the Project area and other City-owned properties as required to perform the necessary Services under this Agreement.
- B. The City shall notify the Contractor of any defects in the Services of which the Contract Administrator has actual notice.

X. ASSIGNMENT

- A. The Contractor shall not subcontract or assign any portion of any right or obligation under this Agreement without prior written consent from the City. Notwithstanding any consent by the City to any assignment, Contractor shall at all times remain bound to all warranties, certifications, indemnifications, promises and performances, however described, as are required of it under the Agreement unless specifically released from the requirement, in writing, by the City.
- B. The Contractor shall retain the right to pledge payment(s) due and payable under this Agreement to third parties.

XI. TERMINATION OF AGREEMENT

- A. If either party is in breach of this Agreement for a period of fifteen (15) days following receipt of notice from the non-breaching party with respect to a breach, the non-breaching party may pursue any remedies available to it against the

breaching party under applicable law, including but not limited to, the right to terminate this Agreement without further notice. The waiver of any breach by any party to this Agreement shall not waive any subsequent breach by any party.

- B. The City may terminate this Agreement, on at least thirty (30) days advance notice, for any reason, including convenience, without incurring any penalty, expense or liability to Contractor, except the obligation to pay for Services actually performed under the Agreement before the termination date.
- C. Contractor acknowledges that, if this Agreement extends for several fiscal years, continuation of this Agreement is subject to appropriation of funds for this Project. If funds to enable the City to effect continued payment under this Agreement are not appropriated or otherwise made available, the City shall have the right to terminate this Agreement without penalty at the end of the last period for which funds have been appropriated or otherwise made available by giving written notice of termination to Contractor. The Contract Administrator shall give Contractor written notice of such non-appropriation within thirty (30) days after it receives notice of such non-appropriation.
- D. The provisions of Articles VI and VIII shall survive the expiration or earlier termination of this Agreement for any reason. The expiration or termination of this Agreement, for any reason, shall not release either party from any obligation or liability to the other party, including any payment obligation that has already accrued and Contractor's obligation to deliver all Deliverables due as of the date of termination of the Agreement.

XII. REMEDIES

- A. This Agreement does not, and is not intended to, impair, divest, delegate or contravene any constitutional, statutory and/or other legal right, privilege, power, obligation, duty or immunity of the Parties.
- B. All rights and remedies provided in this Agreement are cumulative and not exclusive, and the exercise by either party of any right or remedy does not preclude the exercise of any other rights or remedies that may now or subsequently be available at law, in equity, by statute, in any agreement between the parties or otherwise.
- C. Absent a written waiver, no act, failure, or delay by a Party to pursue or enforce any rights or remedies under this Agreement shall constitute a waiver of those rights with regard to any existing or subsequent breach of this Agreement. No waiver of any term, condition, or provision of this Agreement, whether by conduct or otherwise, in one or more instances, shall be deemed or construed as a continuing waiver of any term, condition, or provision of this Agreement. No waiver by either Party shall subsequently effect its right to require strict performance of this Agreement.

XIII. NOTICE

All notices and submissions required under this Agreement shall be delivered to the respective party in the manner described herein to the address stated in this Agreement or such other address as either party may designate by prior written notice to the other. Notices given under this Agreement shall be in writing and shall be personally delivered, sent by next day express delivery service, certified mail, or first class U.S. mail postage prepaid, and addressed to the person listed below. Notice will be deemed given on the date when one of the following first occur: (1) the date of actual receipt; (2) the next business day when notice is sent next day express delivery service or personal delivery; or (3) three days after mailing first class or certified U.S. mail.

If Notice is sent to the CONTRACTOR, it shall be addressed and sent to:

If Notice is sent to the CITY, it shall be addressed and sent to:

City of Ann Arbor

(insert name of Administering Service Area Administrator)

301 E. Huron St.
Ann Arbor, Michigan 48103

XIV. CHOICE OF LAW AND FORUM

This Agreement will be governed and controlled in all respects by the laws of the State of Michigan, including interpretation, enforceability, validity and construction, excepting the principles of conflicts of law. The parties submit to the jurisdiction and venue of the Circuit Court for Washtenaw County, State of Michigan, or, if original jurisdiction can be established, the United States District Court for the Eastern District of Michigan, Southern Division, with respect to any action arising, directly or indirectly, out of this Agreement or the performance or breach of this Agreement. The parties stipulate that the venues referenced in this Agreement are convenient and waive any claim of non-convenience.

XV. OWNERSHIP OF DOCUMENTS

Upon completion or termination of this Agreement, all documents (i.e., Deliverables) prepared by or obtained by the Contractor as provided under the terms of this Agreement shall be delivered to and become the property of the City. Original basic survey notes, sketches, charts, drawings, partially completed drawings, computations, quantities and other data shall remain in

the possession of the Contractor as instruments of service unless specifically incorporated in a deliverable, but shall be made available, upon request, to the City without restriction or limitation on their use. The City acknowledges that the documents are prepared only for the Project. Prior to completion of the contracted Services the City shall have a recognized proprietary interest in the work product of the Contractor.

Unless otherwise stated in this Agreement, any intellectual property owned by Contractor prior to the effective date of this Agreement (i.e., Preexisting Information) shall remain the exclusive property of Contractor even if such Preexisting Information is embedded or otherwise incorporated in materials or products first produced as a result of this Agreement or used to develop Deliverables. The City's right under this provision shall not apply to any Preexisting Information or any component thereof regardless of form or media.

XV. CONFLICTS OF INTEREST OR REPRESENTATION

Contractor certifies it has no financial interest in the Services to be provided under this Agreement other than the compensation specified herein. Contractor further certifies that it presently has no personal or financial interest, and shall not acquire any such interest, direct or indirect, which would conflict in any manner with its performance of the Services under this Agreement.

Contractor agrees to advise the City if Contractor has been or is retained to handle any matter in which its representation is adverse to the City. The City's prospective consent to the Contractor's representation of a client in matters adverse to the City, as identified above, will not apply in any instance where, as the result of Contractor's representation, the Contractor has obtained sensitive, proprietary or otherwise confidential information of a non-public nature that, if known to another client of the Contractor, could be used in any such other matter by the other client to the material disadvantage of the City. Each matter will be reviewed on a case by case basis.

XVII. SEVERABILITY OF PROVISIONS

Whenever possible, each provision of this Agreement will be interpreted in a manner as to be effective and valid under applicable law. However, if any provision of this Agreement or the application of any provision to any party or circumstance will be prohibited by or invalid under applicable law, that provision will be ineffective to the extent of the prohibition or invalidity without invalidating the remainder of the provisions of this Agreement or the application of the provision to other parties and circumstances.

XVIII. EXTENT OF AGREEMENT

This Agreement, together with any affixed exhibits, schedules or other documentation, constitutes the entire understanding between the City and the Contractor with respect to the subject matter of the Agreement and it supersedes, unless otherwise incorporated by reference herein, all prior representations, negotiations, agreements or understandings whether written or

oral. Neither party has relied on any prior representations, of any kind or nature, in entering into this Agreement. No terms or conditions of either party's invoice, purchase order or other administrative document shall modify the terms and conditions of this Agreement, regardless of the other party's failure to object to such form. This Agreement shall be binding on and shall inure to the benefit of the parties to this Agreement and their permitted successors and permitted assigns and nothing in this Agreement, express or implied, is intended to or shall confer on any other person or entity any legal or equitable right, benefit, or remedy of any nature whatsoever under or by reason of this Agreement. This Agreement may only be altered, amended or modified by written amendment signed by the Contractor and the City. This Agreement may be executed in counterparts, each of which shall be deemed an original, but all of which together shall be deemed to be one and the same agreement.

FOR CONTRACTOR

By _____
Type Name
Its

FOR THE CITY OF ANN ARBOR

By _____
Christopher Taylor, Mayor
By _____
Jacqueline Beaudry, City Clerk

Approved as to substance

City Administrator

Type Name
Service Area Administrator

Approved as to form and content

Stephen K. Postema, City Attorney

**EXHIBIT A
SCOPE OF SERVICES**

(Insert/Attach Scope of Work & Deliverables Schedule)

**EXHIBIT B
COMPENSATION**

General

Contractor shall be paid for those Services performed pursuant to this Agreement inclusive of all reimbursable expenses (if applicable), in accordance with the terms and conditions herein. The Compensation Schedule below/attached states nature and amount of compensation the Contractor may charge the City:

(insert/Attach Negotiated Fee Arrangement)

**EXHIBIT C
INSURANCE REQUIREMENTS**

Effective the date of this Agreement, and continuing without interruption during the term of this Agreement, Contractor shall provide certificates of insurance to the City on behalf of itself, and when requested any subcontractor(s). The certificates of insurance shall meet the following minimum requirements.

A. The Contractor shall have insurance that meets the following minimum requirements:

1. Professional Liability Insurance or Errors and Omissions Insurance protecting the Contractor and its employees in an amount not less than \$1,000,000.

2. Worker's Compensation Insurance in accordance with all applicable state and federal statutes. Further, Employers Liability Coverage shall be obtained in the following minimum amounts:

Bodily Injury by Accident - \$500,000 each accident
Bodily Injury by Disease - \$500,000 each employee
Bodily Injury by Disease - \$500,000 each policy limit

3. Commercial General Liability Insurance equivalent to, as a minimum, Insurance Services Office form CG 00 01 07 98 or current equivalent. The City of Ann Arbor shall be an additional insured. There shall be no added exclusions or limiting endorsements which diminish the City's protections as an additional insured under the policy. Further, the following minimum limits of liability are required:

\$1,000,000 Each occurrence as respect Bodily Injury Liability or Property Damage Liability, or both combined
\$2,000,000 Per Job General Aggregate
\$1,000,000 Personal and Advertising Injury

4. Motor Vehicle Liability Insurance, including Michigan No-Fault Coverages, equivalent to, as a minimum, Insurance Services Office form CA 00 01 07 97 or current equivalent. Coverage shall include all owned vehicles, all non-owned vehicles and all hired vehicles. Further, the limits of liability shall be \$1,000,000 for each occurrence as respects Bodily Injury Liability or Property Damage Liability, or both combined.

5. Umbrella/Excess Liability Insurance shall be provided to apply in excess of the Commercial General Liability, Employers Liability and the Motor Vehicle coverage enumerated above, for each occurrence and for aggregate in the amount of \$1,000,000.

- B. Insurance required under A.3 above shall be considered primary as respects any other valid or collectible insurance that the City may possess, including any self-insured retentions the City may have; and any other insurance the City does possess shall be considered excess insurance only and shall not be required to contribute with this insurance. Further, the Contractor agrees to waive any right of recovery by its insurer against the City.

- C. Insurance companies and policy forms are subject to approval of the City Attorney, which approval shall not be unreasonably withheld. Documentation must provide and demonstrate an unconditional 30 day written notice of cancellation in favor of the City of Ann Arbor. Further, the documentation must explicitly state the following: (a) the policy number; name of insurance company; name and address of the agent or authorized representative; name and address of insured; project name; policy expiration date; and specific coverage amounts; (b) any deductibles or self-insured retentions which shall be approved by the City, in its sole discretion; (c) that the policy conforms to the requirements specified. Contractor shall furnish the City with satisfactory certificates of insurance and endorsements prior to commencement of any work. Upon request, the Contractor shall provide within 30 days a copy of the policy(ies) to the City. If any of the above coverages expire by their terms during the term of this contract, the Contractor shall deliver proof of renewal and/or new policies to the Administering Service Area/Unit at least ten days prior to the expiration date.