

ADDENDUM No. 1

RFP No. 18-26

WWTP Area Odor Study

Due: July 24, 2018 by 2:00 p.m. (local time)

The following changes, additions, and/or deletions shall be made to the Request for Proposal for WWTP Area Odor Study, RFP No. 18-26, on which proposals will be received on/or before the date and time listed above.

The information contained herein shall take precedence over the original documents and all previous addenda (if any), and is appended thereto. **This Addendum includes fifty (50) pages.**

The Proposer is to acknowledge receipt of this Addendum No. 1, including all attachments in its Proposal by so indicating in the proposal that the addendum has been received. Proposals submitted without acknowledgement of receipt of this addendum may be considered non-conforming.

The following forms provided within the RFP Document must be included in submitted proposal:

- **Attachment B - Non-Discrimination Declaration of Compliance**
- **Attachment C - Living Wage Declaration of Compliance**
- **Attachment D - Vendor Conflict of Interest Disclosure Form**

Proposals that fail to provide these completed forms listed above upon proposal opening will be rejected as non-responsive and will not be considered for award.

I. QUESTIONS AND ANSWERS

The following Questions have been received by the City. Responses are being provided in accordance with the terms of the RFP. Respondents are directed to take note in its review of the documents of the following questions and City responses as they affect work or details in other areas not specifically referenced here.

1. The City indicated during the Pre-Proposal meeting that four separate seasons of sampling are required. Please confirm.

RESPONSE: The City is requiring that odor monitoring/sampling be conducted over a one-year period to address representative conditions for each of the four seasons.

2. Please indicate the tasks the City will perform and those that the City included in the Consultant's Work Plan related to stakeholder involvement.

RESPONSE: Ann Arbor will provide Consultant access to WWTP facilities and schedule meetings with stakeholders to present and discuss project findings. The Consultant shall be responsible to perform the tasks as outlined in the RFP.

3. Can the city provide a process flow diagram for the entire wastewater treatment system which shows all steps in the process before bids are due?
RESPONSE: We do not have a comprehensive plant process flow diagram. A generalized figure of the plant processes is attached in addition to a plant aerial drawing.

4. Can the city provide the 2006 Plant-wide Odor Study for the Ann Arbor Wastewater Treatment Plant before bids are due?
RESPONSE: The intent of RFP# 18-26 is not to replicate the 2006 Plant-wide Odor Study which focused solely on the WWTP property, but to assess the potential sources of offsite nuisance odors. A \$50M renovation of the Solids Handling Building (Residuals) was completed in 2010 after the 2006 report. The Residuals project included installation of an ammonia scrubber and GAC system as observed during the WWTP walk through. The Residuals project also included installation of a passive GAC contactor to treat off gas from City interceptors at the intersection of the WWTP access road and Old Dixboro Rd. A copy of the 2006 Plant-Wide Odor Study Report table of contents is attached for your reference.

5. What type of “gas detection equipment” is currently used by WWTP staff when investigating off-site odor complaints?
RESPONSE: the primary device staff use is an Industrial Scientific, Ventis MX-4 gas meter. Staff occasionally investigate odor complaints using an OdaLog Type L2 Logger 0-200 ppm H2S.

6. How will “Existing Related Documents and Information” that is currently maintained by the WWTP be made available for review by the successful bidder? That is, will data and information listed on pages 13 and 14 of the RFP be posted on line for electronic viewing, or will these files need to be reviewed in hard-copy format at the WWTP, and then copied by successful bidder.
RESPONSE: Most of the referenced documents will be available electronically although some may only be available as paper documents. Paper documents may be taken offsite and copied by the successful bidder.

7. Will all WWTP operational and performance data be provided to the successful bidder in electronic (excel or database) format?
RESPONSE: Available, requested operational and performance data will be provided to the successful bidder in electronic format.

8. Does the WWTP maintain performance records of system modifications implemented from 2010 to 2017 related to odor reductions? That is, are there any general overall odor testing results or individual influent/effluent concentrations for installed off-gas treatment units?
RESPONSE: No regular testing of the ammonia scrubber and vapor phase GAC contactors has been performed since their installation in 2010. Carbon is changed periodically based on headloss and breakthrough. Carbon was changed out in August 2015. A process flow diagram for the Solids Handling Buildings odor control system is attached.

9. What is the total rate of air draw for odor control system within Solids Handling Building and for other covered unit operations?

RESPONSE: 4,400 CFM. Plant locations where air is collected for treatment using the ammonia scrubber / GAC system include: (1) two blend tanks, (2) gravity thickener tank, (3) four sludge holding tanks, (5) centrifuges, (6) screw conveyors, (7) sludge cake hoppers, and (8) truck loading area. Odor control system information from the system manufacturers O&M is attached.

10. Can the City provide copies of the past nuisance odor complaints from the surrounding communities prior to response to the RFP?

RESPONSE: Annual summaries of odor complaints from 2015 – 2018 are attached along with an example completed form for a June 25, 2018 complaint.

11. Are the locations and readings of the (recent) gas detection equipment (installations) available prior to response to the RFP?

RESPONSE: Locations where WWTP staff have investigated odor complaints have not been mapped. However, locations along Arborview Blvd where odor complaints have been registered are plotted on the attached map.

12. Is traffic control needed to investigate any of the specific areas identified that may be causing the odors? If yes, will it be provided by the City or should it be included in the proposal?

RESPONSE: The successful bidder will be solely responsible to provide traffic control measures required by law to provide safe access for field activities, if needed.

13. Can the study, plans and specs be made available from the Scio Township oxygen injection system program proposed to be implemented (constructed) in August 2018?

RESPONSE: A brief description of the history of odor issues with the Liberty Force Main was prepared by OHM, Scio Townships Engineer, and is attached. Also attached is a brief description of the oxygen injection system prepared by OHM.

14. Can the City provide a list of processes that are currently odor controlled to date and their working status?

RESPONSE: See response to question #9 above. Both the ammonia scrubber and GAC contactors are fully operation and in service at all times.

15. Page 7. First sentence. Should the word “only” be deleted? Are the forms to be included in the technical proposal only or both the technical and fee proposals?

RESPONSE: The RFP language is correct. Attachments B, C, and D must be included with the Technical Proposal. If these Attachments are not provided with the Technical Proposal, the proposal will be considered non-responsive.

16. Page 11. In section 2. Objective in the third sentence starting with “The objective of this study....” What is the “.....future potential study/.....” for? Isn’t the purpose of this study to define the plant’s odor sources and recommend mitigation measures, that would presumably be carried into design?

RESPONSE: If follow-up work is needed prior to design of odor control mitigation equipment a future potential study phase may be needed. The purpose of the RFP# 18-26 study is to identify / quantify potential of offsite nuisance odor sources for the subject areas. The WWTP may not be the singular source of odors which is why the study is to also look at potential sources of odors outside the plant fence.

17. Will City of Ann Arbor staff be responsible for identifying all stakeholders, including concerned citizens?

RESPONSE: Yes. The WWTP has been meeting semi-annually for years with the Towsley Farms Subdivision stakeholders group. The group also includes representatives from Ann Arbor Township, St. Joe Hospital and Washtenaw Community College. The WWTP will continue to be the point of contact with this group during the Odor Study period.

Offerors are responsible for any conclusions that they may draw from the information contained in the Addendum.

Question # 3

Supporting Information

Plant Treatment Processes

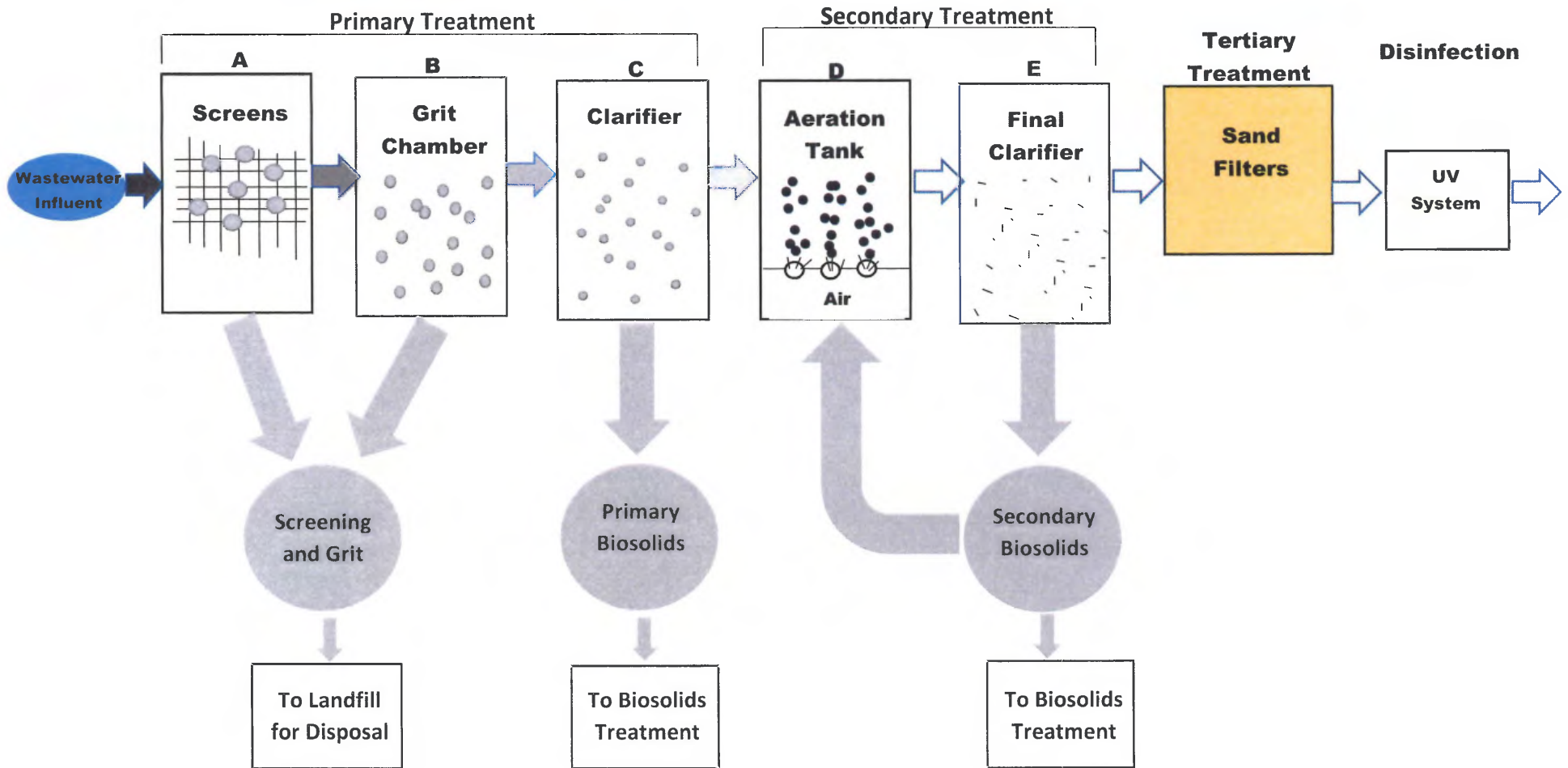

Question # 4

Supporting Information

**City of Ann Arbor, Michigan
Wastewater Treatment Plant**

Residuals Handling Improvements Project

**Draft
Plant-wide Odor Study for
the Ann Arbor Wastewater
Treatment Plant**

June 2006



GREELEY AND HANSEN

Table of Contents

1.0	INTRODUCTION	1-1
2.0	IDENTIFICATION OF POTENTIAL SOURCES OF ODOROUS COMPOUNDS AND CONCENTRATIONS.....	2-1
2.1	General.....	2-1
2.2	Odor Complaints.....	2-1
2.3	Existing Odor Control Units.....	2-1
2.4	Identification of Odor Sources.....	2-2
2.5	Field Sampling Techniques.....	2-3
2.5.1	Odor Testing.....	2-3
2.5.2	Time of Day for Sampling.....	2-4
2.5.3	Weather During Sampling.....	2-5
2.5.4	Field (Drager) and Laboratory Analyses.....	2-5
2.5.5	Summary of Location, Number and Sample Types.....	2-5
2.6	Discussion of Findings.....	2-5
2.6.1	Manhole at Plant Entrance on Dixboro Road.....	2-6
2.6.1.1	Field Sensory Observations.....	2-6
2.6.1.2	Laboratory Analysis.....	2-6
2.6.1.3	Odor Potential.....	2-6
2.6.2	Overflow Structure at Plant Entrance Bridge.....	2-7
2.6.2.1	Field Sensory Observations.....	2-7
2.6.2.2	Laboratory Analysis.....	2-7
2.6.2.3	Odor Potential.....	2-7
2.6.3	Influent Screw Pumps - Headspace.....	2-7
2.6.3.1	Field Sensory Observations.....	2-7
2.6.3.2	Laboratory Analysis.....	2-8
2.6.3.3	Odor Potential.....	2-8
2.6.4	Screen and Grit Building.....	2-8
2.6.4.1	Field Sensory Observations.....	2-8
2.6.4.2	Laboratory Analysis.....	2-8
2.6.4.3	Odor Potential.....	2-8
2.6.5	Flow Splitting Structure.....	2-9
2.6.5.1	Field Sensory Observations.....	2-9
2.6.5.2	Laboratory Analysis.....	2-9
2.6.5.3	Odor Potential.....	2-9
2.6.6	Retention Basin.....	2-9
2.6.6.1	Field Sensory Observations.....	2-9
2.6.6.2	Laboratory Analysis.....	2-9
2.6.6.3	Odor Potential.....	2-9
2.6.7	Equalization Basin.....	2-10
2.6.7.1	Field Sensory Observations.....	2-10
2.6.7.2	Laboratory Analysis.....	2-10
2.6.7.3	Odor Potential.....	2-10



Table of Contents

2.6.8	East Plant Primary Tanks - Effluent Trough.....	2-10
	2.6.8.1 Field Sensory Observations	2-10
	2.6.8.2 Laboratory Analysis.....	2-11
	2.6.8.3 Odor Potential.....	2-11
2.6.9	East Plant Flow Splitting Structure.....	2-11
	2.6.9.1 Field Sensory Observations	2-11
	2.6.9.2 Laboratory Analysis.....	2-11
	2.6.9.3 Odor Potential.....	2-11
2.6.10	East Plant Primary Scum Well.....	2-11
	2.6.10.1Field Sensory Observations	2-11
	2.6.10.2Laboratory Analysis.....	2-12
	2.6.10.3Odor Potential.....	2-12
2.6.11	Gravity Thickening Tank.....	2-12
	2.6.11.1Field Sensory Observations	2-12
	2.6.11.2Laboratory Analysis.....	2-12
	2.6.11.3Odor Potential.....	2-12
2.6.12	Liquid Sludge Holding Tank #1 (Without Lime)	
	2.6.12.1Field Sensory Observations	2-13
	2.6.12.2Laboratory Analysis.....	2-13
	2.6.12.3Odor Potential.....	2-13
2.6.13	Liquid Sludge Holding Tank #3 (With Lime)	2-13
	2.6.13.1Field Sensory Observations	2-13
	2.6.13.2Laboratory Analysis.....	2-13
	2.6.13.3Odor Potential.....	2-14
2.6.14	Cake Hopper	2-14
	2.6.14.1Field Sensory Observations	2-14
	2.6.14.2Laboratory Analysis.....	2-14
	2.6.14.3Odor Potential.....	2-14
2.6.15	Truck Loading Area - Liquid Sludge.....	2-14
	2.6.15.1Field Sensory Observations	2-14
	2.6.15.2Laboratory Analysis.....	2-15
	2.6.15.3Odor Potential.....	2-15
2.6.16	Truck Loading Area - Cake Sludge	2-15
	2.6.16.1Field Sensory Observations	2-15
	2.6.16.2Laboratory Analysis.....	2-15
	2.6.16.3Odor Potential.....	2-15
2.7	Plant Wide Odor Potential Prioritization	2-16
2.8	Recommended Odor Control Actions.....	2-18
	2.8.1 Manhole at Plant Entrance on Dixboro Road	2-19
	2.8.2 Overflow Structure at Plant Entrance Bridge	2-20
	2.8.3 Influent Screw Pumps - Headspace	2-20
	2.8.4 Screen and Grit Building	2-20
	2.8.5 Flow Splitting Structure.....	2-20
	2.8.6 West Plant Primary Tank - Effluent Trough.....	2-21
	2.8.7 Retention Basin.....	2-21



Table of Contents

2.8.8	Equalization Basin	2-21
2.8.9	East Plant Primary Tank - Effluent Trough	2-22
2.8.10	East Plant Flow Splitting Structure	2-22
2.8.11	East Plant Primary Scum Well	2-22
2.8.12	Gravity Thickening Tanks	2-22
2.8.13	Scum Concentration Room	2-23
2.8.14	Liquid Sludge Holding Tanks	2-23
2.8.15	Centrifuge Vent Exhaust Air	2-23
2.8.16	Truck Loading Area - Cake Sludge Hoppers	2-23
2.8.17	GBT Room	2-24
3.0	DEVELOPMENT OF ODOR CONTROL ALTERNATIVES	3-1
3.1	Odor Control Treatment System Alternatives	3-1
3.1.1	Single-Stage Packed Bed Chemical Scrubbers	3-1
3.1.2	Multi-Stage Packed Bed Chemical Scrubbers	3-2
3.1.3	Mist Type Chemical Scrubbers	3-2
3.1.4	Granular Activated Carbon (GAC)	3-2
3.1.5	Biofilters	3-2
3.1.6	Bio-Towers	3-3
3.1.7	Ozone Contact Chambers	3-4
3.1.8	Impregnated Media Beds (Activated Alumina Impregnated With Potassium Permanganate)	3-4
3.1.9	Vent to Atmosphere Untreated	3-4
3.1.10	Odor Control Alternatives Advantages and Disadvantages	3-6
3.1.10.1	Single-Stage or Multi-Stage Chemical Scrubbers	3-6
3.1.10.2	Mist Type Chemical Scrubbers	3-7
3.1.10.3	Granular Activated Carbon	3-7
3.1.10.4	Bio-Towers	3-7
3.1.10.5	Bio-Filters - Open Bed	3-8
3.1.10.6	Bio-Filters - In Vessel Type	3-9
3.1.10.7	Ozone Contact Chamber	3-9
3.1.10.8	Impregnated Media Beds	3-9
4.0	EVALUATION OF ODOR CONTROL ALTERNATIVES	4-1
4.1	Odor Control Alternatives Recommended for Detailed Evaluation	4-1
4.2	Odor Control Alternatives Evaluation	4-3
4.2.1	Odor Control System No. 1A	4-3
4.2.2	Odor Control System No. 1B	4-3
4.2.3	Odor Control System No. 2	4-4
4.2.3.1	Alternative No. 1	4-4
4.2.3.2	Alternative No. 2	4-5
4.2.3.3	Alternative No. 3	4-5

Table of Contents

	4.2.4 Odor Control System No. 3	4-6
	4.2.4.1 Alternative No. 1	4-6
	4.2.4.2 Alternative No. 2	4-6
	4.2.5 Odor Control System No. 4	4-7
	4.2.5.1 Alternative No. 1	4-7
	4.2.5.2 Alternative No. 2	4-8
	4.2.5.3 Alternative No. 3	4-8
5.0	RECOMMENDED ODOR CONTROL FACILITIES	5-1
5.1	Odor Control Alternatives Recommendations.....	5-1
5.1.1	Odor Control System No. 1A	5-1
5.1.2	Odor Control System No. 1B.....	5-1
5.1.3	Odor Control System No. 2	5-2
5.1.4	Odor Control System No. 3	5-2
5.1.5	Odor Control System No. 4	5-3
6.0	PUBLIC ENGAGEMENT	6-1
6.1	Stakeholder Involvement	6-1
6.1.1	Public Engagement Meetings	6-1

Appendices

Appendix A	Odor Complaints
Appendix B	Laboratory Results
Appendix C	Field Sampling Techniques
Appendix D	Odor Control System Schematics
Appendix E	Public Engagement Meetings



Question # 8

Supporting Information

3.2 Odor Control

Normal Function and Description

The odor control system consists of three granular activated carbon adsorption units (OCUs) and a water ammonia scrubber system for control of ammonia. The odor control system is located in the SHB, El 776'-0". The OCW receives air from sludge holding tanks, centrifuges, screw conveyors, pugmills and dewatered cake storage hoppers for treatment of ammonia, which will subsequently be sent to the OCUs. The OCUs also receive air from the blend tanks, the gravity thickener tank and the Gravity Thickener Building for odor control. Refer to Figure 3-3 in Appendix G for Odor Control Flow Diagram. Refer to Figure 3-4 in Appendix G for the Odor System Control Diagram. Equipment data for the Odor System is shown in Table 3-1 through Table 3-4.

Actuated Carbon Adsorption Units

The ACAU includes the following:

- OCU-1 and OCU-2
- Ductwork and Dampers
- Exhaust Fans (OCF-1 and OCF-2)
- Fan Outlet/Absorber Inlet Transition
- Carbon Absorber Vessel
- Activated Carbon Media
- Discharge stack with rain shield
- Control Panel

During normal operation two activated carbon OCUs operate with one in stand-by. The activated carbon absorber vessel is fabricated from premium grade vinyl ester resin FRP to withstand a maximum of 7 inches water column of positive internal pressure. The following accessories are provided with the vessels:

- 20-inch flanged gas inlet connection
- 20-inch flanged gas outlet connection
- 2-inch PVC NPT single point water drain connection
- Two 1-inch PVC NPT single point pressure tap connection
- 24-inch diameter access sample probes
- Three 1-inch carbon sample probes
- Hold down lifting lugs, of galvanized construction
- Manually operated butterfly damper to regulate airflow through the absorber vessel
- Carbon sample probes, three 1-inch diameter sample probes per vessel which extend a minimum of 12-inches into the carbon bed
- Differential pressure gauge to continuously monitor the pressure drop across the carbon bed



Each absorber vessel is furnished with radial flow activated carbon having an average depth of 30 inches. Carbon bed is supported on the sides by inner and outer FRP round lattice tubes with polypropylene screens. The screen and support system is removable through access man ways.

Water Ammonia Scrubber

The OCW includes the following:

- OCW-1
- Exhaust Fans (OCF-3 & OCF-4)
- Mist Eliminator
- Ductwork and Dampers
- Water Feed System
- Integral absorber with three scrubbing stages

The ammonia scrubber system (OCW) provides treatment to ammonia laden air from contaminated areas in a single pass and is a single odor control system designed for continuous operation. The scrubber system is capable of withstanding a temperature of 150 °F. The scrubber system is a three-stage, once through packed absorber of unitary construction, able to remove 95 percent of the inlet ammonia vapor in a single pass.

The system consists of three vertical gas adsorption sections consisting of a countercurrent section, a co-current section and another countercurrent section. The packed sections include spray headers to distribute the liquid evenly over the packing sections. The gases pass through a high efficiency mist eliminator prior to discharging into the stack. The scrubber is equipped with a self contained sump, fitted with a low level switch and a high level switch.

The mist eliminator is a high efficiency chevron-type at the discharge end of the system. Each mist eliminator to remove 99 percent of all mist particles 40 microns and larger and 90 percent of mist particles 10 microns and larger. A liquid distributor with nozzle is provided to manually spray dilute hydrochloric acid for mist eliminator and packing washing. The scrubber system is also provided with an exhaust stack. The following accessories are provided with the ammonia scrubber system:

- Makeup water controls
- Scrubber recirculation sump blowdown
- Differential pressure gauges

Methods of Control

The odor control system is started and stopped locally and the PICS system is for monitoring only. PICS displays the operating and alarm status for odor control fans and odor control washer sump level alarms.



The differential pressure across each OCUs and the air plenum pressure is also included in the display. Alarms are activated based on air plenum pressure settings as follows:

- Low alarm below -3 inches water column
- High alarm above +3 inches water column

At the OCW-1 Control Panel there is a RUNNING indicating light and an ON-OFF-AUTO selector switch. The selector switch controls the OCW as follows:

- ON position, OCW runs continuously.
- OFF position, OCW does not respond to local or remote controls.
- AUTO position, OCW is operated through interlock signals from the MCC to turn on the washer whenever OCF-3 or OCF-4 runs.

The OCW also has a high level, low level switch and an alarm for the sump that is active only when the OCW is called to operate to indicate either a plugged drain or loss of water supply. The solenoid valve (ON-OFF) is used for once through water. Refer to Figure 3-4 in Appendix G for the Odor System Control Diagram.

Modes of Operation

Refer to the Odor Control Equipment Operation and Maintenance manual for equipment specific modes of operation including start-up and shutdown procedures, maintenance requirements and troubleshooting guide.



Equipment Data

Table 3-1: Odor Control Units

OCU-1, -2 & -3

No. of Units	3
Manufacturer	Bay Products, Hawk Radial Flow type
Exhaust air flow rate each-sfcm	6,150
Vessel diameter, feet	9.0
Height, feet	8, overall
Carbon bed depth, inches	30
Carbon volume per vessel	354.4 ft ³ (11,142 lbs)
H ₂ S inlet concentration, ppm v/v	
Average	3
Peak	10
Exhaust air temperature, °F	100, maximum
Exhaust air humidity, %	100, maximum
H ₂ S concentration in treated exhaust air-ppm v/v	
@ Average H ₂ S concentration in inlet air	0.1
@ Peak H ₂ S concentration in inlet air	0.1
Max allowable static pressure lost thru carbon bed	7.0 inches wc @ normal operation
Capacity	20 Tons
Minimum H ₂ S breakthrough capacity, g H ₂ S removed/cc carbon	0.28

Table 3-2: Odor Control Fans

OCF-1 & -2

No. of Units	2
Manufacturer	New York Blower Company
Model	FE 302 HP
Configuration	Bottom horizontal discharge, OCF-1: Clockwise rotation OCF-2: Counter Clockwise rotation
Speed	1800 RPM
Motor	25Hp, Explosion proof
Electrical usage/ power requirements	460 V/ 3phase/60 Hz
Capacity	9600 cfm @11.0" w.c. and 1780 rpm

Operation and Maintenance Manual

Table 3-3: Odor Control Washer

OCW-1	
No. of Units	1
Manufacturer	Bay Products
Exhaust air flow rate each-sfcm	4,400
Inlet NH ₃ concentration, ppm	250
Outlet NH concentration, ppm	12.5
Unit length, feet	7.5(L) x3'(W) x12.6'(H)
Stage-1	3'x3'x10.7'
Stage-2	1.5'x3'x10.7'
Stage-3	3'x3'x10.7'
Max allowable pressure drop across scrubber, in wc	8.5
Scrubber maximum operating weight, lbs	8,000
Minimum NH ₃ removal efficiency, %	95
Maximum water temperature, °F	77
Maximum water usage rate, gal/min for 95% removal	28
Stack diameter, feet	1.67
Maximum stack exit velocity, fpm removed/cc carbon	2,500
Media Type	Q-PAC from Lanec, Inc
Material	Polypropylene

Table 3-4: Odor Control Fans

OCF-3 &-4	
No. of Units	2
Manufacturer	New York Blower Company
Model	FE 182 HP
Configuration	Bottom horizontal discharge, OCF-3: Clockwise rotation OCF-4: Counter Clockwise rotation
Speed	1800 RPM
Motor	10Hp, Explosion proof
Electrical usage/ power requirements	460 V/ 3phase/60 Hz
Capacity	3900 cfm @8.5" w.c. and 2685 rpm

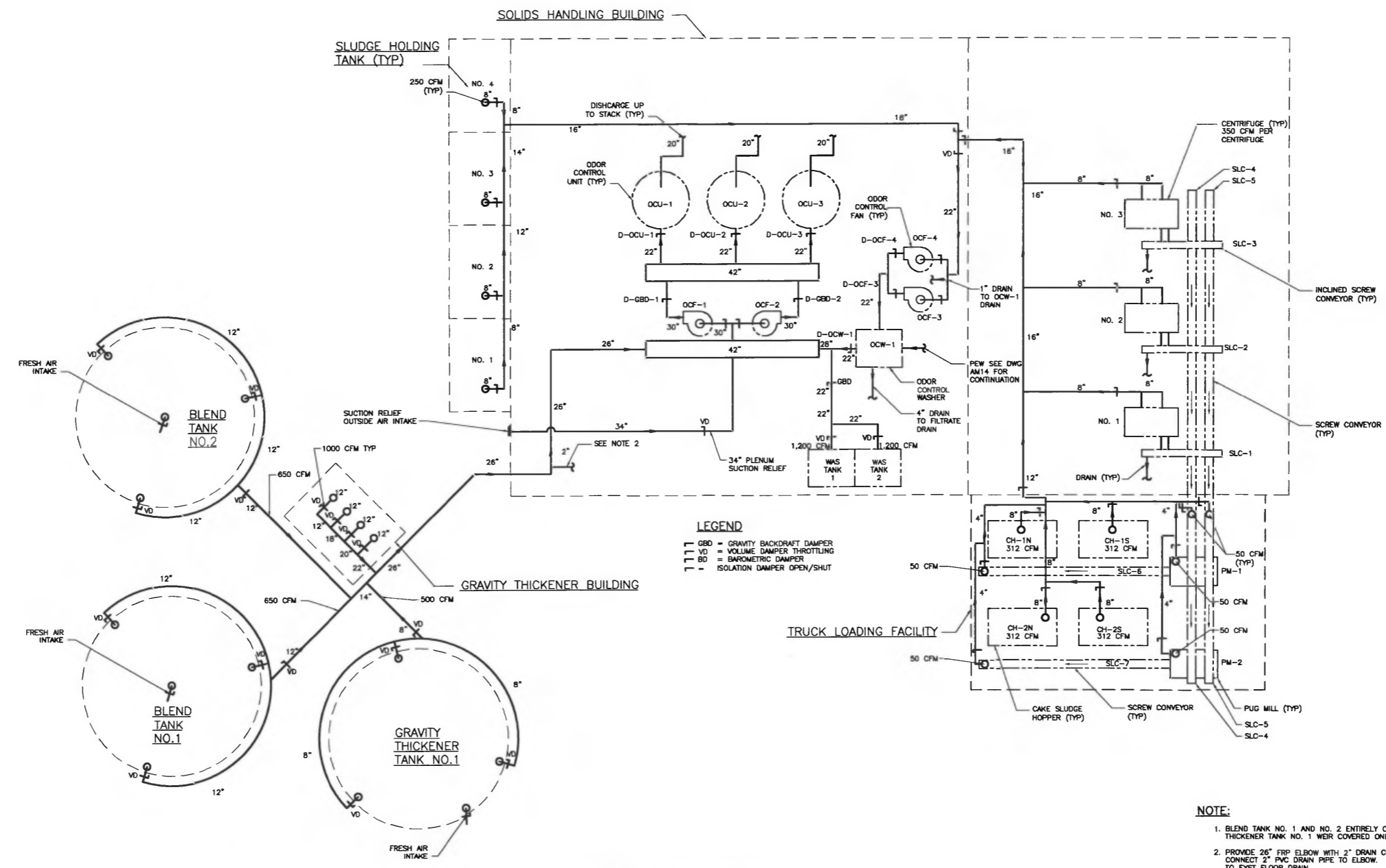

ODOR CONTROL DIAGRAM
SCALE: NOT TO SCALE

LEGEND
 ▬ GBD = GRAVITY BACKDRAFT DAMPER
 VD = VOLUME DAMPER THROTTLING
 ▬ BD = BAROMETRIC DAMPER
 ▬ = ISOLATION DAMPER OPEN/SHUT

NOTE:
 1. BLEND TANK NO. 1 AND NO. 2 ENTIRELY COVERED. GRAVITY THICKENER TANK NO. 1 WEIR COVERED ONLY.
 2. PROVIDE 26" FRP ELBOW WITH 2" DRAIN CONNECTION AT LOW POINT. CONNECT 2" PVC DRAIN PIPE TO ELBOW. ROUTE 2" PVC DRAIN PIPE TO EXIST FLOOR DRAIN.

RECORD DRAWING
 THIS RECORD IS NOT WARRANTED BUT IS BELIEVED TO REPRESENT CONDITIONS UPON COMPLETION OF CONSTRUCTION WITHIN REASONABLE TOLERANCES. BASED UPON THE INFORMATION FURNISHED TO AND COLLECTED BY THE ENGINEER PERTAINING TO CHANGES MADE DURING CONSTRUCTION.

GREELY AND HANSEN 211 WEST FORT STREET, SUITE 710 DETROIT, MICHIGAN 48226-3202	DESIGNED	AJM	APPROVED		SCALE NOT TO SCALE	CITY OF ANN ARBOR, MICHIGAN WASTEWATER TREATMENT PLANT RESIDUALS HANDLING IMPROVEMENTS PROJECT	GENERAL PIPING AND EQUIPMENT ODOR CONTROL DIAGRAM	FILE NAME	02141AM11.DWG		
	DRAWN	AJM						DWG	AM11		
	CHECKED	JMG						DATE	AUGUST 2012	REV	0
				NO.	DATE	APPD	REVISION				
				1	8/12	NBS	AS-BUILTS				

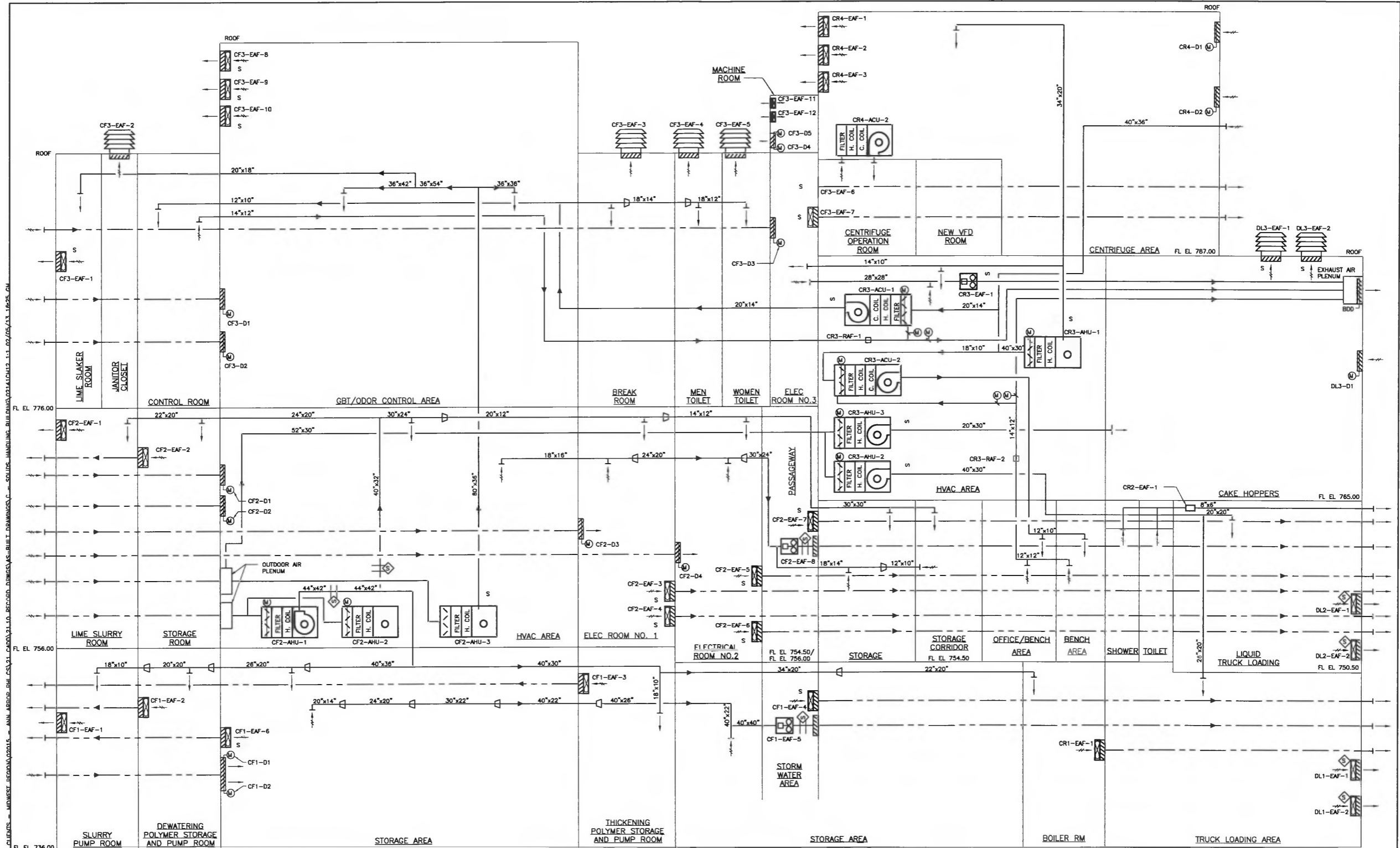

AIR FLOW DIAGRAM
SCALE: NOT TO SCALE

LEGEND
 - - - SUPPLY/EXHAUST AIR FROM/TO BUILDING EXTERIOR
 ——— HVAC DUCT

RECORD DRAWING
 THIS RECORD IS NOT WARRANTED BUT IS BELIEVED TO REPRESENT CONDITIONS UPON COMPLETION OF CONSTRUCTION WITHIN REASONABLE TOLERANCES. BASED UPON THE INFORMATION FURNISHED TO AND COLLECTED BY THE ENGINEER PERTAINING TO CHANGES MADE DURING CONSTRUCTION.

GREELEY AND HANSEN
 211 WEST FORT STREET, SUITE 710
 DETROIT, MICHIGAN 48226-3202

DESIGNED	BW	APPROVED	
DRAWN	TK		
CHECKED	GVS		

NO.	DATE	APPD	REVISION
1	8/12	NBS	AS-BUILTS

CITY OF ANN ARBOR, MICHIGAN
 WASTEWATER TREATMENT PLANT
 RESIDUALS HANDLING IMPROVEMENTS PROJECT

SOLIDS HANDLING BUILDING
 HVAC
 AIR FLOW DIAGRAM

FILE NAME	02141CH12.DWG
DWG	CH12
DATE	AUGUST 2012
REV	0

02141BOR
 XREFS:

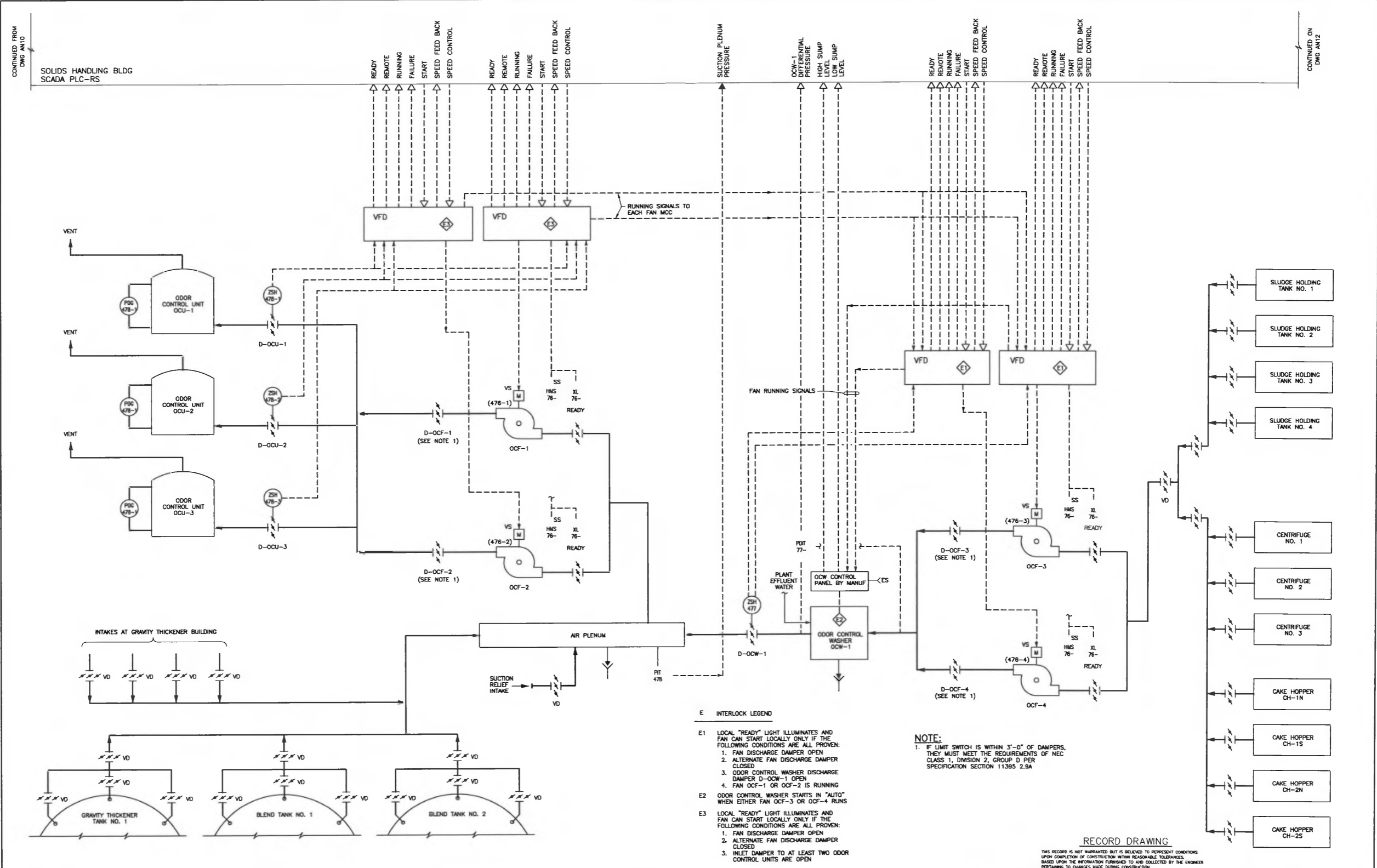

- E INTERLOCK LEGEND**
- E1 LOCAL "READY" LIGHT ILLUMINATES AND FAN CAN START LOCALLY ONLY IF THE FOLLOWING CONDITIONS ARE ALL PROVEN:
 1. FAN DISCHARGE DAMPER OPEN
 2. ALTERNATE FAN DISCHARGE DAMPER CLOSED
 3. ODOR CONTROL WASHER DISCHARGE DAMPER D-OCW-1 OPEN
 4. FAN OCF-1 OR OCF-2 IS RUNNING
 - E2 ODOR CONTROL WASHER STARTS IN "AUTO" WHEN EITHER FAN OCF-3 OR OCF-4 RUNS
 - E3 LOCAL "READY" LIGHT ILLUMINATES AND FAN CAN START LOCALLY ONLY IF THE FOLLOWING CONDITIONS ARE ALL PROVEN:
 1. FAN DISCHARGE DAMPER OPEN
 2. ALTERNATE FAN DISCHARGE DAMPER CLOSED
 3. INLET DAMPER TO AT LEAST TWO ODOR CONTROL UNITS ARE OPEN

NOTE:
 1. IF LIMIT SWITCH IS WITHIN 3'-0" OF DAMPERS, THEY MUST MEET THE REQUIREMENTS OF NEC CLASS 1, DIVISION 2, GROUP D PER SPECIFICATION SECTION 11395 2.9A

RECORD DRAWING
THIS RECORD IS NOT WARRANTED BUT IS BELIEVED TO REPRESENT CONDITIONS UPON COMPLETION OF CONSTRUCTION WITHIN REASONABLE TOLERANCES. BASED UPON THE INFORMATION FURNISHED TO AND COLLECTED BY THE ENGINEER PERTAINING TO CHANGES MADE DURING CONSTRUCTION.

Greeley and Hansen
 211 WEST FORT STREET, SUITE 710
 DETROIT, MICHIGAN 48226-3202

DESIGNED TRG
 DRAWN TRG
 CHECKED JMG

NO.	DATE	APPD	REVISION
1	8/12	NBS	AS-BUILTS

SCALE
 NO SCALE

CITY OF ANN ARBOR, MICHIGAN
 WASTEWATER TREATMENT PLANT
 RESIDUALS HANDLING IMPROVEMENTS PROJECT

GENERAL INSTRUMENTATION AND CONTROL
 ODOR CONTROL
 P&ID

FILE NAME: 02141AN11.DWG
 DWG: AN11
 DATE: AUGUST 2012 REV: 0

EXHAUST AND RETURN AIR FANS / ODOR CONTROL FANS

08/28/07 H:\PROJECTS\Ann Arbor\ESSELEC\SCHEDULES\A-FAF.XLS\$TWS

UNIT I.D.	LOCATION	AREA(S) SERVED	TYPE	FAN					MOTOR					MANUFACTURER/ MODEL NO	REMARKS/NOTES	
				TYPE	DIA	CFM (HIGH)	RPM (HIGH)	EXT SP (LOW)	O.V. FPM	BHP	HP	ELEC. V/PH/Hz	TYPE DRIVE			
CF1-EAF-1	LIME TRANSFER EQ RM EL 736	LIME TRANSFER EQ RM EL 736	WALL PROPELLER FAN	PANEL	28 DIA	1000	1750	0.5	---	0.22	0.25	1750	120/1/60	DIRECT	GREENHECK / S1-12-432-A4	
CF1-EAF-2	POLYMER STG RM EL 736	POLYMER STG RM EL 736	WALL PROPELLER FAN	PANEL	28 DIA	2000	1038	0.5	462	0.58	0.75	1750	460/3/60	BELT	HARTZELL / A95G-28	
CF1-EAF-3	POLYMER PUMP ROOM EL 736	POLYMER PUMP ROOM EL 736	WALL PROPELLER FAN	PANEL	28 DIA	1000	1750	0.5	---	0.22	0.25	1750	120/1/60	DIRECT	GREENHECK / S1-12-432-A4	
CF1-EAF-4	STORAGE AREA EL 736	STORAGE AREA EL 736	WALL PROPELLER FAN	PANEL	32 DIA	5000	1050	0.5	885	1.07	1.50	1750	460/3/60	BELT	HARTZELL / A95H-32	
CF1-EAF-5	STORAGE AREA EL 736	CF2-AHU-1	IN-LINE EXHAUST FAN	HORIZ.	33DA	18800	1113	2	1683	11.83	15.00	1750	460/3/60	BELT	HARTZELL / A04-9-33	
CF1-EAF-6	STORAGE AREA EL 736	STORAGE AREA EL 736	WALL PROPELLER FAN	PANEL	36 DIA	12000	1044	0.5	1680	2.06	2.50	1750	460/3/60	BELT	HARTZELL / S095G-36	
CF2-EAF-1	LIME SLURRY RM EL 756	LIME SLURRY ROOM EL 756	WALL PROPELLER FAN	PANEL	28 DIA	2000	1038	0.5	462	0.58	0.75	1750	460/3/60	BELT	HARTZELL / A95G-28	
CF2-EAF-2	STORAGE	STORAGE	WALL PROPELLER FAN	PANEL	24 DIA	200	847	0.375	63	0.20	0.25	1750	120/1/60	BELT	HARTZELL / A95G-24	
CF2-EAF-3	ELECTRICAL ROOM EL 754.5	ELECTRICAL ROOM EL 754.5	WALL PROPELLER FAN	PANEL	28 DIA	4000	1203	0.5	923	0.83	1.00	1750	460/3/60	BELT	HARTZELL / A95H-28	
CF2-EAF-4	ELECTRICAL ROOM EL 754.5	ELECTRICAL ROOM EL 754.5	WALL PROPELLER FAN	PANEL	28 DIA	4000	1203	0.5	923	0.83	1.00	1750	460/3/60	BELT	HARTZELL / A95H-28	
CF2-EAF-5	ELECTRICAL RM EL 754.5	ELECTRICAL RM EL 754.5	WALL PROPELLER FAN	PANEL	32 DIA	8000	1136	0.5	1416	1.31	1.50	1750	460/3/60	BELT	HARTZELL / A95G-32	
CF2-EAF-6	ELECTRICAL RM EL 754.5	ELECTRICAL RM EL 754.5	WALL PROPELLER FAN	PANEL	32 DIA	8000	1136	0.5	1416	1.31	1.50	1750	460/3/60	BELT	HARTZELL / A95G-32	
CF2-EAF-7	STORAGE EL 754.5	HVAC AREA EL 756	WALL PROPELLER FAN	PANEL	36 DIA	12000	1044	0.5	1680	2.06	2.50	1750	460/3/60	BELT	HARTZELL / S095G-36	
CF2-EAF-8	MESSAGWAY	CF2-AHU-2	IN-LINE EXHAUST FAN	HORIZ.	36 DIA	12000	721	2	902	5.32	7.50	1750	460/3/60	BELT	HARTZELL / A04-9-36	
CF3-EAF-1	LIME SLAKER RM EL 776	LIME SLAKER ROOM EL 776	WALL PROPELLER FAN	PANEL	28 DIA	2800	1115	0.5	646	0.68	1.00	1750	460/3/60	BELT	HARTZELL / A95G-28	
CF3-EAF-2	ROOF	JANITOR CLOSET EL 776	ROOF TOP EXHAUST	VERT	---	70	1590	0.5	---	51 W	1/80	1590	120/1/60	DIRECT	GREENHECK / LDP 95	
CF3-EAF-3	ROOF	BREAK ROOM EL 776	ROOF TOP EXHAUST	VERT	---	500	1550	0.5	---	160 W	1/80	1550	120/1/60	DIRECT	HARTZELL / LDP 95	
CF3-EAF-4	ROOF	WOMEN TOILET EL 776	ROOF TOP EXHAUST	VERT	---	150	1665	0.5	---	73 W	1/30	1665	120/1/60	DIRECT	HARTZELL / LDP 70	
CF3-EAF-5	ROOF	MEN TOILET EL 776	ROOF TOP EXHAUST	VERT	---	500	1550	0.5	---	92 W	1/75	1550	120/1/60	DIRECT	HARTZELL / LDP 90	
CF3-EAF-6	ELECTRICAL RM EL 776	ELECTRICAL ROOM EL 776	WALL PROPELLER FAN	PANEL	28 DIA	3000	1133	0.5	692	0.71	0.75	1750	460/3/60	BELT	HARTZELL / A95G-28	
CF3-EAF-7	ELECTRICAL RM EL 776	ELECTRICAL ROOM EL 776	WALL PROPELLER FAN	PANEL	28 DIA	3000	1133	0.5	692	0.71	0.75	1750	460/3/60	BELT	HARTZELL / A95G-28	
CF3-EAF-8	MECHANICAL ROOM EL 776	CF2-AHU-3	WALL PROPELLER FAN	PANEL	80 DIA	18000	706	0.5	911	3.25	5.00	1750	460/3/60	BELT	HARTZELL / A95H-80	
CF3-EAF-9	MECHANICAL ROOM EL 776	CF2-AHU-3	WALL PROPELLER FAN	PANEL	80 DIA	18000	706	0.5	911	3.25	5.00	1750	460/3/60	BELT	HARTZELL / A95H-80	
CF3-EAF-10	MECHANICAL ROOM EL 776	ODOR CONTROL AREA EL 776	WALL PROPELLER FAN	PANEL	80 DIA	18000	706	0.5	911	3.25	5.00	1750	460/3/60	BELT	HARTZELL / A95H-80	
CF3-EAF-11	MACHINE RM EL 810.0	ELEVATOR RM EL 810.0	WALL PROPELLER FAN	PANEL	80 DIA	1550	1550	0.375	---	190 W	1/80	1550	120/1/60	DIRECT	GREENHECK / S1-12-432-D	
CF3-EAF-12	MACHINE RM EL 810.0	ELEVATOR RM EL 810.0	WALL PROPELLER FAN	PANEL	---	800	1550	0.375	---	190 W	1/80	1550	120/1/60	DIRECT	GREENHECK / S1-12-432-D	
CR1-EAF-1	BOILER RM EL 736	BOILER ROOM EL 736	WALL PROPELLER FAN	PANEL	---	400	1550	0.5	---	120 W	0.10	1550	120/1/60	DIRECT	GREENHECK / S1-12-426-D	
CR2-EAF-1	IT MAINT. TOILET EL 754.5	SHOWER & TOILET EL 754.5	IN-LINE EXHAUST FAN	HORIZ.	27 DIA	200	1550	0.5	0.65	1/12	1550	120/1/60	DIRECT	GREENHECK / S0-80-D		
CR3-EAF-1	MECHANICAL ROOM EL 765	WARRIOS	IN-LINE EXHAUST FAN	HORIZ.	27 DIA	7000	917	2	895	3.3	5.00	1750	460/3/60	BELT	HARTZELL / A04-9-27	
CR3-EAF-2	MECHANICAL ROOM EL 765	CR3-ACU-1	IN-LINE EXHAUST FAN	HORIZ.	12 DIA	1000	2064	2	649	0.48	0.75	1750	460/3/60	BELT	HARTZELL / A04-9-12	
CR3-EAF-3	MECHANICAL ROOM EL 765	CR3-ACU-2	IN-LINE EXHAUST FAN	HORIZ.	12 DIA	1000	2064	2	649	0.48	0.75	1750	460/3/60	BELT	HARTZELL / A04-9-12	
CR4-EAF-1	CENTRIFUGES EL 787	CR3-AHU-1	WALL PROPELLER FAN	PANEL	32 DIA	6000	1090	0.5	1062	1.18	1.50	1750	460/3/60	BELT	HARTZELL / A95G-32	
CR4-EAF-2	CENTRIFUGES EL 787	CENTRIFUGES EL 787	WALL PROPELLER FAN	PANEL	32 DIA	6000	1090	0.5	1062	1.18	1.50	1750	460/3/60	BELT	HARTZELL / A95G-32	
CR4-EAF-3	CENTRIFUGES EL 787	CENTRIFUGES EL 787	WALL PROPELLER FAN	PANEL	32 DIA	6000	1090	0.5	1062	1.18	1.50	1750	460/3/60	BELT	HARTZELL / A95G-32	
DL1-EAF-1	TRUCK LOAD EL 736	CR3-AHU-2	WALL PROPELLER FAN	PANEL	28 DIA	3500	1176	0.5	808	0.78	1.00	1750	460/3/60	BELT	HARTZELL / A95G-28	
DL1-EAF-2	TRUCK LOAD EL 736	CR3-AHU-2	WALL PROPELLER FAN	PANEL	28 DIA	3500	1176	0.5	808	0.78	1.00	1750	460/3/60	BELT	HARTZELL / A95G-28	
DL2-EAF-1	HOPPERS EL 750.5	CR3-AHU-2	WALL PROPELLER FAN	PANEL	28 DIA	3500	1176	0.5	808	0.78	1.00	1750	460/3/60	BELT	HARTZELL / A95G-28	
DL2-EAF-2	HOPPERS EL 750.5	CR3-AHU-2	WALL PROPELLER FAN	PANEL	28 DIA	3500	1176	0.5	808	0.78	1.00	1750	460/3/60	BELT	HARTZELL / A95G-28	
DL3-EAF-1	ROOF	CR3-AHU-3	ROOF TOP EXHAUST	VERT	---	5000	411	0.5	---	0.87	1.00	1750	460/3/60	BELT	GREENHECK / LBP 30-10	
DL3-EAF-2	ROOF	MECHANICAL ROOM EL 765	ROOF TOP EXHAUST	VERT	---	5000	411	0.5	---	0.87	1.00	1750	460/3/60	BELT	GREENHECK / LBP 30-10	
OCF-1	MECHANICAL RM EL 776	ODOR CONTROL SYSTEM	BASE CENTRIFUGAL	HORIZ. ARRGT 9	9600	1959	11.0	2275	21.8	25.00	1750	460/3/60	BELT	HARTZELL / A41-9-27	FRP, VFD, EXPLOSION PROOF	
OCF-2	MECHANICAL RM EL 776	ODOR CONTROL SYSTEM	BASE CENTRIFUGAL	HORIZ. ARRGT 9	9600	1959	11.0	2275	21.8	25.00	1750	460/3/60	BELT	HARTZELL / A41-9-27	FRP, VFD, EXPLOSION PROOF	
OCF-3	ODOR CONTROL FAN RM EL 776	ODOR CONTROL SYSTEM	BASE CENTRIFUGAL	HORIZ. ARRGT 9	3900	2912	8.5	2349	7.5	10.00	1750	460/3/60	BELT	HARTZELL / A41-9-18	FRP, VFD, EXPLOSION PROOF	
OCF-4	ODOR CONTROL FAN RM EL 776	ODOR CONTROL SYSTEM	BASE CENTRIFUGAL	HORIZ. ARRGT 9	3900	2912	8.5	2349	7.5	10.00	1750	460/3/60	BELT	HARTZELL / A41-9-18	FRP, VFD, EXPLOSION PROOF	

PUMPS

H:\PROJECTS\Ann Arbor\ESSELEC\SCHEDULES\A-PUMPS.XLS TWS 08/03/07

UNIT I.D.	LOCATION	SERVICE	TYPE	FLUID		MOTOR		ELEC.		MANUFACTURER	MODEL NO	REMARKS/NOTES
				GPM	HEAD FT	BHP	HP	RPM	V/PH/Hz			
CR1-HPP-1A	BOILER ROOM EL 736	PLANT HOT WATER HEATING LOOP	PRIMARY LOOP	1400	80	40.00	1780	460/3/60	BELL & GOSSETT	VSC 5x6x10-1/2	VFD	
CR1-HPP-1B	BOILER ROOM EL 736	PLANT HOT WATER HEATING LOOP	PRIMARY LOOP	1400	80	40.00	1780	460/3/60	BELL & GOSSETT	VSC 5x6x10-1/2	VFD/STAND-BY	
CF2-HSP-1	HVAC AREA EL 756	CF2-AHU-1	HOT WATER SEC PUMP	160	25	2.00	1180	460/3/60	BELL & GOSSETT	3x3x9-1/2B	IN-LINE PUMPS	
CF2-HSP-2	HVAC AREA EL 756	CF2-AHU-2	HOT WATER SEC PUMP	98	25	1.50	1180	460/3/60	BELL & GOSSETT	3x3x9-1/2B	IN-LINE PUMPS	
CF2-HSP-3	HVAC AREA EL 756	CF2-AHU-3	HOT WATER SEC PUMP	270	25	3.00	1150	460/3/60	BELL & GOSSETT	SERIES 80 4x4x9-1/2		
CR1-HSP-1	BOILER ROOM EL 736	CR1-HWB-1	BOILER CIRCULATING PUMP	1200	16	10.00	1180	460/3/60	BELL & GOSSETT	VSC 5x6x10-1/2		
CR1-HSP-2	BOILER ROOM EL 736	CR1-HWB-2	BOILER CIRCULATING PUMP	1200	16	10.00	1180	460/3/60	BELL & GOSSETT	VSC 5x6x10-1/2		
CR1-HSP-3	BOILER ROOM EL 736	NEW ADMIN BLDG	HOT WATER SEC PUMP	900	80	30.00	1780	460/3/60	BELL & GOSSETT	VSC 5x6x10-1/2	VFD	
CR1-HSP-4	BOILER ROOM EL 736	NEW ADMIN BLDG	HOT WATER SEC PUMP	900	80	30.00	1780	460/3/60	BELL & GOSSETT	VSC 5x6x10-1/2	VFD	
CR1-HSP-5	BOILER ROOM EL 736	EXIST EAST/WEST PLANT	HOT WATER SEC PUMP	550	80	25.00	1780	460/3/60	BELL & GOSSETT	VSC 4x8x10-1/2		
CR1-HSP-6	BOILER ROOM EL 736	EXIST EAST/WEST PLANT	HOT WATER SEC PUMP	550	80	25.00	1780	460/3/60	BELL & GOSSETT	VSC 4x8x10-1/2		
CR1-HSP-7	TRUCK LOAD/BOILER RM EL 736	UNIT HEATERS	HOT WATER SEC PUMP	25	25	0.75	1150	460/3/60	BELL & GOSSETT	SERIES 80 1-1/2x1-1/2x7B		
CR1-GFP-1	BOILER ROOM EL 736	MAKE-UP WATER SYSTEM	CENTRIFUGAL TANK	8	90	0.33	1750	115/1/60	BELL & GOSSETT	PART OF MAKE-UP PACKAGE		
CR3-HSP-1	HVAC AREA EL 765	CR3-AHU-1	HOT WATER SEC PUMP	90	25	1.50	1150	460/3/60	BELL & GOSSETT	SERIES 80 2x2x7		
CR3-HSP-2	HVAC AREA EL 765	CR3-AHU-2	HOT WATER SEC PUMP	98	25	1.50	1150	460/3/60	BELL & GOSSETT	SERIES 80 2-1/2x2-1/2x9-1/2B		
CR3-HSP-3	HVAC AREA EL 765	CR3-AHU-3	HOT WATER SEC PUMP	35	25	0.75	1150	460/3/60	BELL & GOSSETT	SERIES 80 1-1/2x1-1/2x9-1/2		
CR3-HSP-4	HVAC AREA EL 765	CR3-ACU-1	HOT WATER SEC PUMP	10	25	0.17	3300	115/1/60	BELL & GOSSETT	BOOSTER PL-36		
CR3-HSP-5	HVAC AREA EL 765	CR3-ACU-2	HOT WATER SEC PUMP	5	25	0.17	3300	115/1/60	BELL & GOSSETT	BOOSTER PL-36		
CR4-HSP-1	OPERATOR RM CEILING EL 787	CR4-ACU-1	HOT WATER SEC PUMP	10	25	0.17	3300	115/1/60	BELL & GOSSETT	BOOSTER PL-36		

BOILERS (WATER/GLYCOL)

H:\PROJECTS\Ann Arbor\ESSELEC\SCHEDULES\A-HWB.XLS TWS 03/28/07

UNIT I.D.	AREA OR SYSTEM SERVED	LOCATION	TYPE	MBH		WATER		GLYCOL		BURNER		ELECTRICAL		MANUFACTURER	REMARKS/NOTES		
				IN	OUT	ENT LWT	RET LWT	ENT GPM	RET GPM	FUEL TYPE	FAN HP	CONTROL	PUMP COMP (HP)			CHW V/PH/Hz	TOT KW
CR1-HWB-1	PLANT HOT WATER HEATING	BOILER ROOM EL 736	HOT WATER BOILER	20925	16740	200	1200	220	180	40	NG	20925	10	MODULATING	---	460/3/60	CLEAVER BROOKS CB 500
CR1-HWB-2	PLANT HOT WATER HEATING	BOILER ROOM EL 736	HOT WATER BOILER	20925	16740	200	1200	220	180	40	NG	20925	10	MODULATING	---	460/3/60	CLEAVER BROOKS CB 500

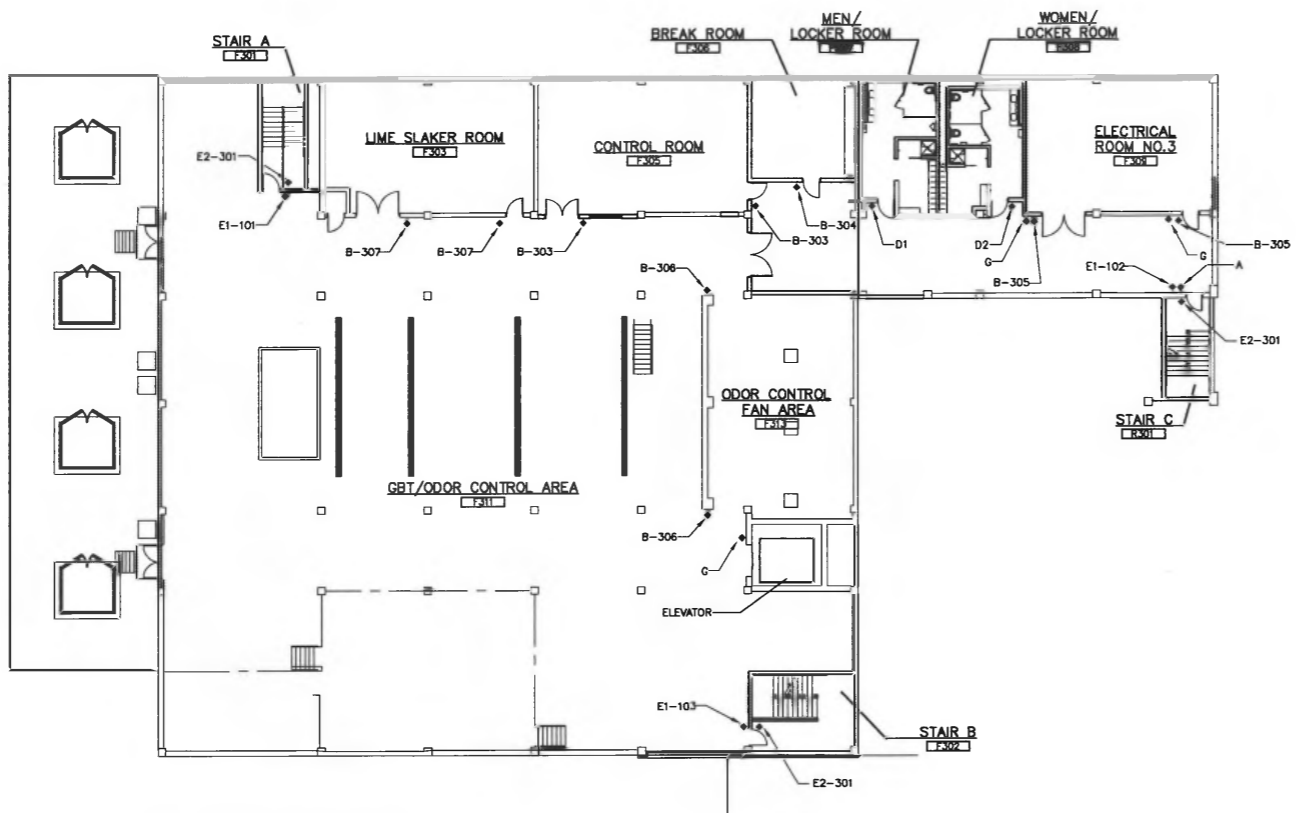
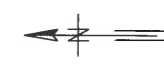

F3 PLAN AT EL.776.00
NOT TO SCALE

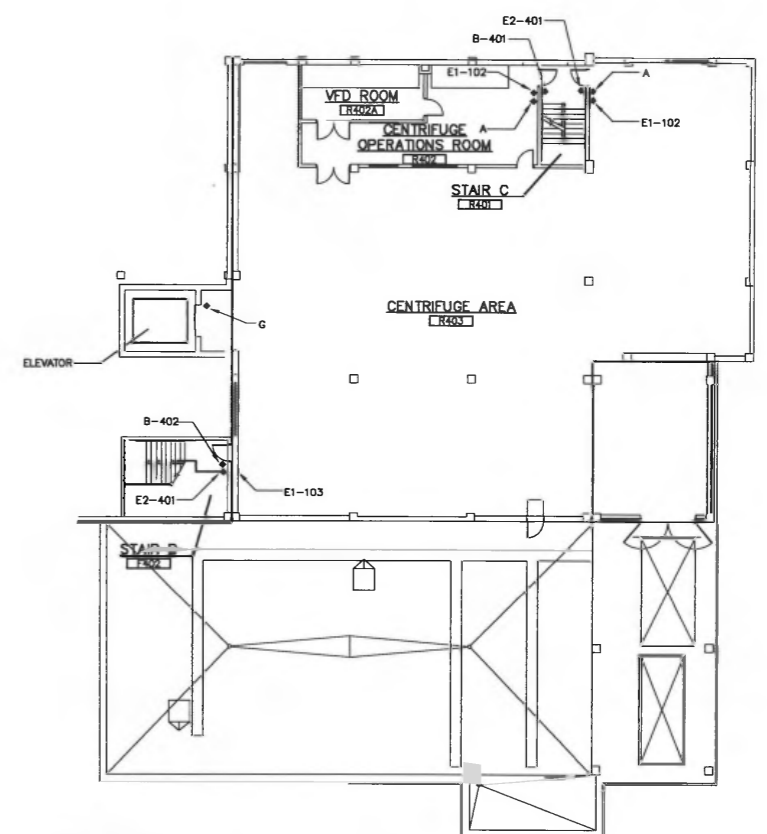

R4 PLAN AT EL.787.00
NOT TO SCALE

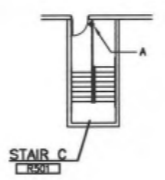

F4 ROOF PLAN
NOT TO SCALE

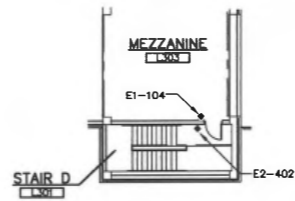

PLAN AT EL.776.25
NOT TO SCALE

RECORD DRAWING

THIS RECORD IS NOT WARRANTED BUT IS BELIEVED TO REPRESENT CONDITIONS UPON COMPLETION OF CONSTRUCTION WITHIN REASONABLE TOLERANCES BASED UPON THE INFORMATION FURNISHED TO AND COLLECTED BY THE ENGINEER PERTAINING TO CHANGES MADE DURING CONSTRUCTION.

GREELEY AND HANSEN
211 WEST FORT STREET, SUITE 710
DETROIT, MICHIGAN 48226-3202

DESIGNED DS
DRAWN DS
CHECKED TCB

APPROVED

NO.	DATE	APPD.	REVISION
1	8/12	NBS	AS-BUILTS

SCALE

CITY OF ANN ARBOR, MICHIGAN
WASTEWATER TREATMENT PLANT
RESIDUALS HANDLING IMPROVEMENTS PROJECT

GENERAL ARCHITECTURAL
SIGNAGE
PLANS AT EL.776.00 AND 787.00

FILE NAME 02141AA12.DWG
DWG AA12
DATE AUGUST 2012 REV 0

Question # 9

Supporting Information

Introduction

This manual is intended to serve as a reference guide for the installation, operation and maintenance of the Odor Control System for the Residual Handling Improvements at Ann Arbor, MI. Bay Products advises operators to read through the manual to become familiar with the equipment and its safe operation. Careful consideration should be given to Safety, Installation, Start-up and Shutdown.

This system is designed for the removal of noxious, hazardous or unpleasant hydrogen sulfide odors. The Bay Products operations personnel should be contacted a minimum of three weeks prior to the desired operation date to schedule startup assistance.

Equipment Description

The supplied system is a standard Bay Products Hawk Radial Flow Odor Control System. Refer to enclosed standard brochure and radial flow design spreadsheet.

The total system operates by pulling foul air from the source at a maximum of 12,300 cubic feet per minute. Each individual vessel is designed for a maximum flow of 6,150 cubic feet per minute. The foul air is pushed into the side of the fiberglass vessel. The foul air moves radially through the carbon bed where odorous compounds are removed by the activated sties on the carbon. Clean air is then passed out the top opening and directed to a suitable discharge location. There are ports on the vessel for drain connection, media sampling, and differential pressure measurement. The exhausted air shall contain no more than 0.1 ppm H₂S concentration. The carbon media shall remove a minimum of 99% of H₂S from a concentration level up to 10 ppm at the inlet. This system is designed for continuous operation in ambient temperatures ranging from 15°F to 150°F and humidity levels up to 100%. The carbon adsorption units are capable of withstanding a maximum of 7" w.c. of positive internal pressure and are designed to be suitable for continuous exposure to hydrogen sulfide gas as specified in Section 11395, 2.3.A.

The UniScrub 4400 is a multi-stage packed FRP system of unitary construction. It is designed for continuous operation in temperatures up to 150°F. The scrubber is capable of removing a minimum 95% of an inlet ammonia vapor concentration at 250 ppm.

The system operates by pulling foul air from the source at a maximum of 4,400 cubic feet per minute. This system is designed to treat ammonia laden air from contaminated areas in a single pass through the vessel. The foul air is pushed into the inlet plenum located at the bottom of the Stage-1 fiberglass reaction chamber. The first chamber is filled with packing material which the foul air passes up through, countercurrent to the spray header water flow. The treated air then flows through the Stage-2 transfer channel in a co-current pattern to the bottom of the Stage-3 chamber. The Stage-3 chamber is a countercurrent flow stage, identical to the Stage-1 chamber and shall be the final stage of media. At the exhaust of the vessel, shall be a chevron type mist

eliminator pad to prevent water droplets from exiting the system in the air stream. Spray headers shall run above Stage-1 and Stage-3 and a spray header shall run below the mist eliminator pad to provide a pad wash system. The spray headers shall be supplied with water from the Plant Effluent Water. An integral insulated sump shall be provided at the base of the vessel to collect the reclaimed water and discharge to the drain.

CUSTOMER ASSISTANCE CONTACT LIST

Manufacturer

Bay Products, Inc.
P.O. Box 4859
Stateline, NV 89449
Phone: (775) 586-8500
Fax: (775) 586-8501

Contractor

De-Cal Inc.
24659 Schoenherr Rd
Warren, MI 48089
Phone: (586) 709-1122

Local Representative

Bay Products, Inc.
PO Box 127
Belton, TX 76513
Phone: (254) 933-3100
Fax: (254) 933-2212

Design Calculations:

The following is the design basis for Hawk Radial Flow :

Air Flow:	6,150 cfm
Vessel Diameter:	9 feet
Media Volume:	345.4 ft ³
Contact Time:	3.37 seconds

A. ACTIVATED CARBON (see specification sheet)

Approximately 7,600 lbs (235.6 cubic feet) per vessel, of High Capacity carbon as specified. A total of approximately 22,800 pounds shall be supplied by Bay Products. Each lot of carbon shall be delivered with an accompanying analysis sheet. The carbon has been manufactured to adsorb vapor phase organic and malodorous compounds of the type typically generated in municipal wastewater. This media has a 99% removal rate of H₂S and organic sulfides at the specified inlet concentrations. The media shall remove 95% minimum of non sulfide VOC at the specified concentrations.

The carbon has the following specifications:

Apparent Density (g/cc)	0.39 – 0.41
Moisture	8% max.
H ₂ S Breakthrough Capacity (g/cc of carbon)	0.28 min.
Mean Particle Diameter	3.9 – 4.1 mm

Design Calculations

Air Flow:	6,150 cfm
Vessel Diameter:	108"
Carbon Volume:	345.4 ft ³
Contact Time:	3.37 seconds

B. INSTRUMENTATION

1. Differential Pressure Gauge (see attached data sheet)

Quantity: 3 Total
1 per vessel

Manufacturer: Dwyer

Series: Magnehelic

Model: 2010

Range: 0 – 10 inches water column

Enclosure: Die cast aluminum with corrosion resistant coating

Mounting: FRP bracket on the vessel sidewall
316 stainless steel fasteners

Connection: PE MPT connectors
Polypropylene tubing

NOZZLE SCHEDULE FOR OCW-1											
MARK NO.	QTY	CONNECTION TYPE	I.D./SIZE	O.D.	B.C.	# OF HOLES	HOLE DIA.	DRILLING PATTERN	LOCATION	ELEVATION	SERVICE
A	1	FLANGE	32"x12"	38"x18"	-	-	-	CUSTOM	90°	20"	AIR INLET
B	1	FLANGE	36"	40 3/8"	39"	32	1/2"	PS 15-69	270° - 27° OFF C	TOP	AIR OUTLET
C	1	FLANGE	24"	28 3/8"	27"	20	1/2"	PS 15-69	90° - 27° OFF C	TOP	MEDIA ACCESS
D	1	FLANGE	18"	22 3/8"	21"	16	1/2"	PS 15-69	0° - 27° OFF C TOWARDS 270°	116"	MEDIA ACCESS
E	1	FLANGE	18"	22 3/8"	21"	16	1/2"	PS 15-69	0° - 27° OFF C TOWARDS 270°	45°	MANWAY
F	1	FLANGE	18"	22 3/8"	21"	16	1/2"	PS 15-69	0° - 27° OFF C TOWARDS 270°	13"	SUMP ACCESS
G	1	FLANGE	18"	22 3/8"	21"	16	1/2"	PS 15-69	0° - 27° OFF C TOWARDS 90°	45°	MANWAY
H	1	FLANGE	8"	12 3/8"	11"	8	1/2"	PS 15-69	180° - 27° OFF C TOWARDS 270°	122"	SPRAY HEADER
J	1	FLANGE	8"	12 3/8"	11"	8	1/2"	PS 15-69	180° - 27° OFF C TOWARDS 90°	122"	SPRAY HEADER
K	1	FULL CPLG - FNPT	1"	-	-	-	-	-	180° - 27° OFF C TOWARDS 270°	131"	SPRAY HEADER (MIST PAD)
L	1	FULL CPLG - FNPT	1/2"	-	-	-	-	-	180° - 27° OFF C TOWARDS 270°	158"	D.P. GAUGE CONNECTION
M	1	FULL CPLG - FNPT	1/2"	-	-	-	-	-	180° - 11° OFF C TOWARDS 270°	120"	D.P. GAUGE CONNECTION
N	1	FULL CPLG - FNPT	1/2"	-	-	-	-	-	180° - 11° OFF C TOWARDS 90°	26"	D.P. GAUGE CONNECTION
P	1	HALF CPLG - FNPT	4"	-	-	-	-	-	180° - 27° OFF C TOWARDS 90°	3 1/2"	DRAIN
Q	1	HALF CPLG - FNPT	1"	-	-	-	-	-	180° - 11° OFF C TOWARDS 270°	118"	AIR SAMPLE PORT
R	1	HALF CPLG - FNPT	1"	-	-	-	-	-	180° - 11° OFF C TOWARDS 90°	23"	AIR SAMPLE PORT
S	1	-	-	-	-	-	-	-	180° - 27° OFF C TOWARDS 90°	88"	NAME PLATE
T	1	-	-	-	-	-	-	-	180° - 39° OFF C TOWARDS 90°	88"	D.P. GAUGE BRACKET
U	1	-	-	-	-	-	-	-	0° - 40° OFF C TOWARDS 270°	-	ANCHOR CLIP
V	1	-	-	-	-	-	-	-	0° - 40° OFF C TOWARDS 90°	-	ANCHOR CLIP
W	1	-	-	-	-	-	-	-	180° - 40° OFF C TOWARDS 90°	-	ANCHOR CLIP
X	1	-	-	-	-	-	-	-	180° - 40° OFF C TOWARDS 270°	-	ANCHOR CLIP
Y	1	FLANGE - CUSTOM	36"x11"	42"x11"	-	-	-	-	270° - 27° OFF C	143 1/8"	MIST PAD ACCESS
Z	1	-	-	-	-	-	-	-	-	60"	WATER PANEL
AA	1	FULL CPLG - FNPT	2"	-	-	-	-	-	180° - 18° OFF C TOWARDS 90°	2 3/8"	LOW LEVEL

VESSEL SPECIFICATIONS			
	CORROSION BARRIER	STRUCTURAL LAYER	EXTERIOR LAYER
THICKNESS	100 MILS	0.275"	N/A
RESIN SYSTEM	VIPEL FD10	VIPEL F737	N/A
COLOR	NATURAL	NATURAL	VALSPAR 5W-1 WHITE

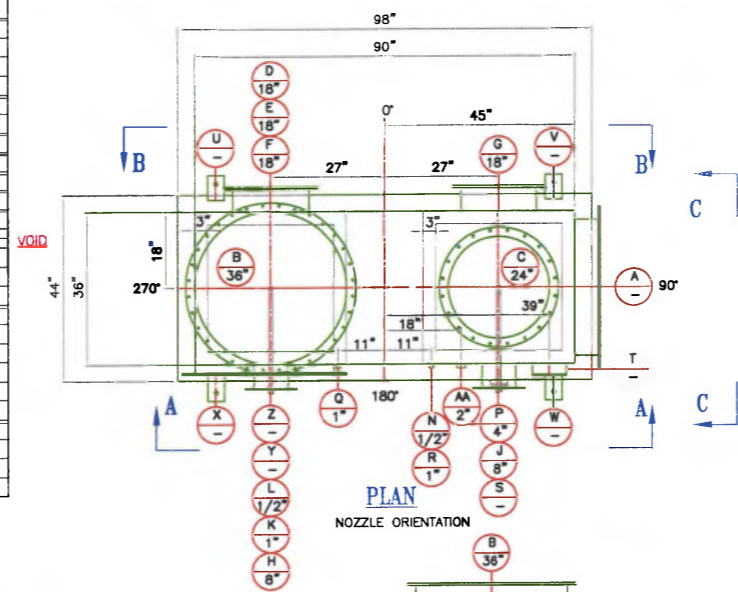

- COLOR: VALSPAR 5W-1 WHITE
- TOTAL WALL THICKNESS: 0.375"
- BOTTOM THICKNESS: 0.375"
- TOP THICKNESS: 0.375"
- APPLICATION OF GEL COAT W/UV INHIBITOR ON VESSEL EXTERIOR.
- FOR HOLD DOWN ANCH

.WG #09-320-OCW1-LS-01.

- MEDIA SUPPORT: 1 1/2"x1 1/2" SQUARE MESHx1 1/2" THK FRP GRATING WITH GRATING SUPPORTED 3"x1/2" THK RING
- CORROSION BARRIER
 - NEXUS VEIL: 1 LAYER
 - 1.5oz MATT: 2 LAYER

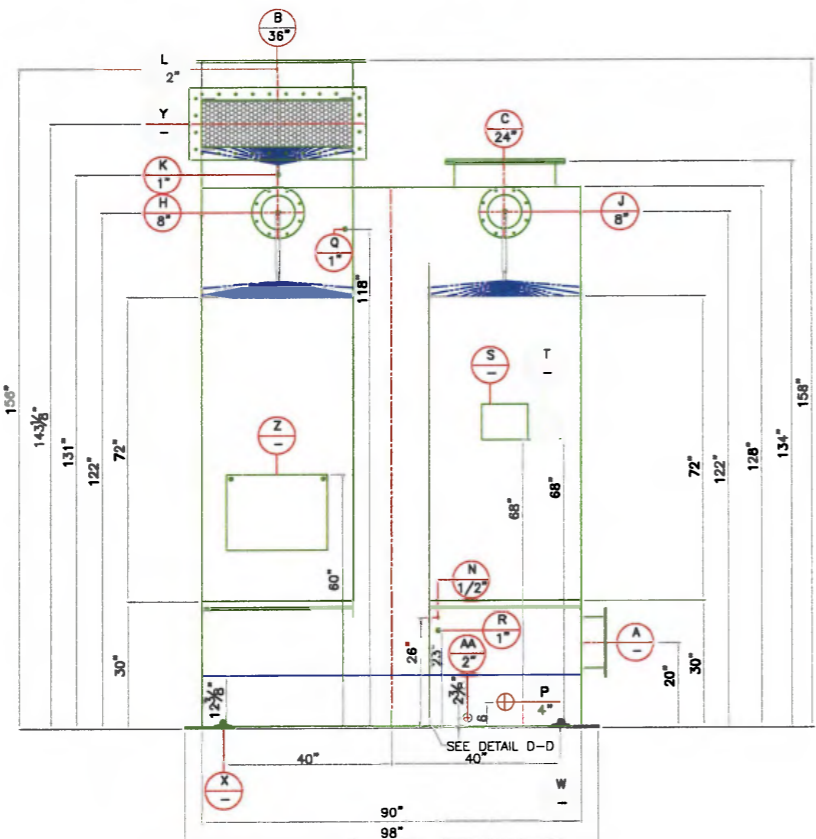

ELEVATION A-A
FRONT VIEW

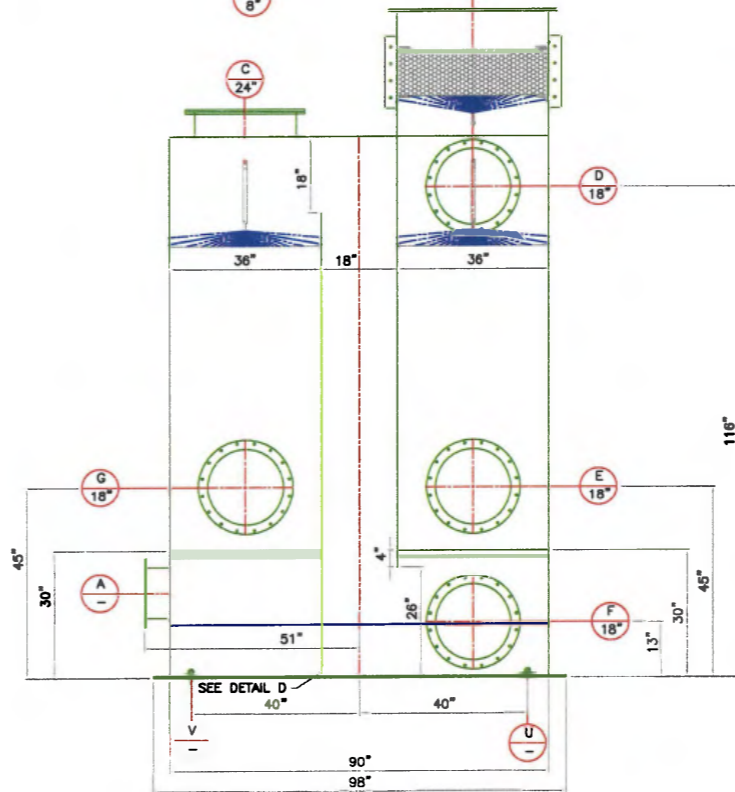

ELEVATION B-B
BACK VIEW

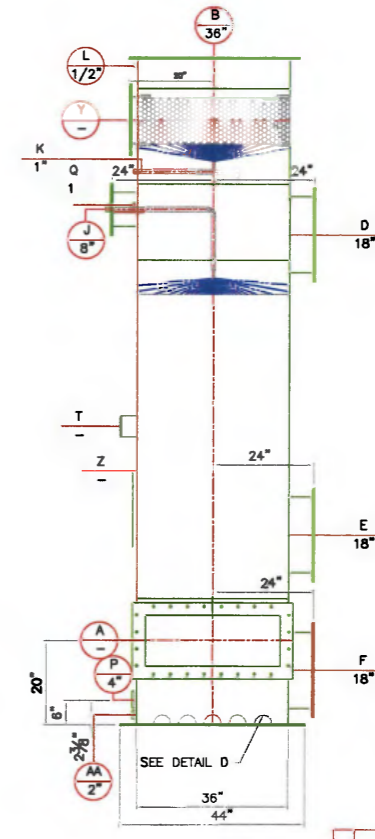

SECTION C-C
NOZZLE "C" ON UNIT TOP REMOVED FOR CLARITY

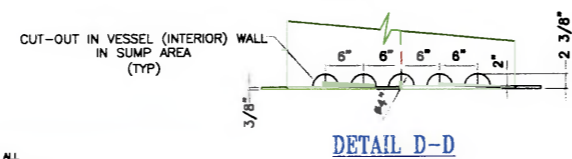

DETAIL D-D

NOTE: SUBMITTAL DRAWINGS ARE BASED ON CONTRACT DRAWINGS AND SPECIFICATIONS. IT IS THE RESPONSIBILITY OF THE CONTRACTOR TO VERIFY ALL APPROVED DRAWINGS BEFORE FABRICATION AGAINST EACH OTHER AND FIELD CONDITIONS. BAY PRODUCTS WILL NOT BE RESPONSIBLE FOR ANY EQUIPMENT FABRICATED THAT REQUIRES FIELD MODIFICATION IF BUILT IN ACCORDANCE WITH ANY APPROVED AND VENDOR DRAWINGS. ALSO, SOME FLANGE CONNECTIONS MAY BE SUPPLIED UNDRILLED TO ENSURE PROPER FIT. THESE FLANGES MUST BE FIELD DRILLED AND ARE THE RESPONSIBILITY OF THE CONTRACTOR.

BAY PRODUCTS, INC
P.O. BOX 4809
STORING, MI 48445
1-800-428-0190

1	REVISED	DATE	BY

09-320 ANN ARBOR, MI

FRP ODOR CONTROL SYSTEM
WATER AMMONIA SCRUBBER - OCW-1

TKB	DATE	APPROVED	DATE
09-320	09-320-OCW1-01		

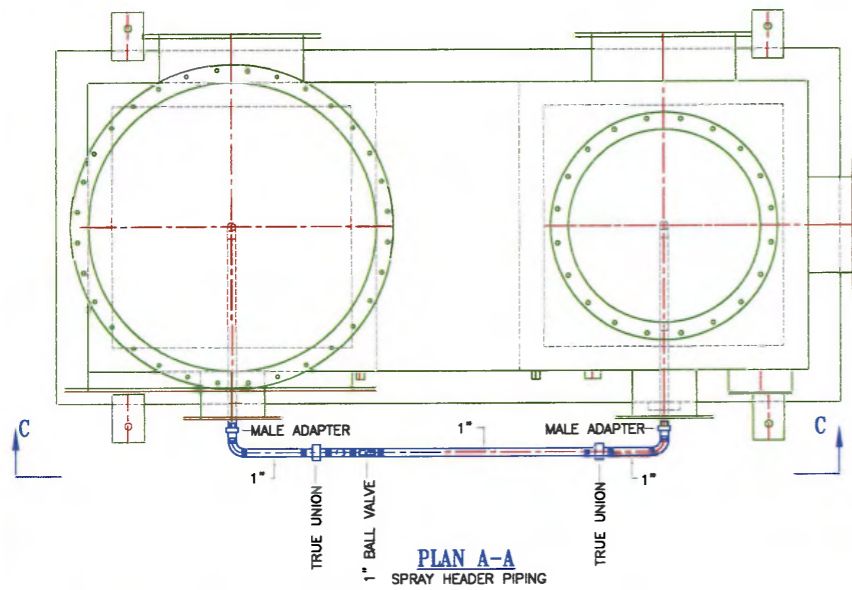

PLAN A-A
SPRAY HEADER PIPING

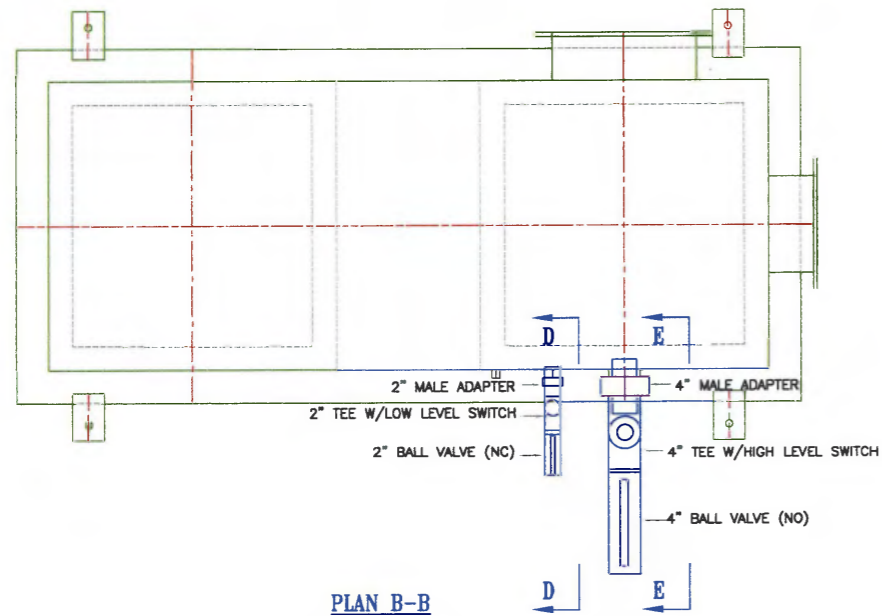

PLAN B-B
LEVEL SWITCH PIPING

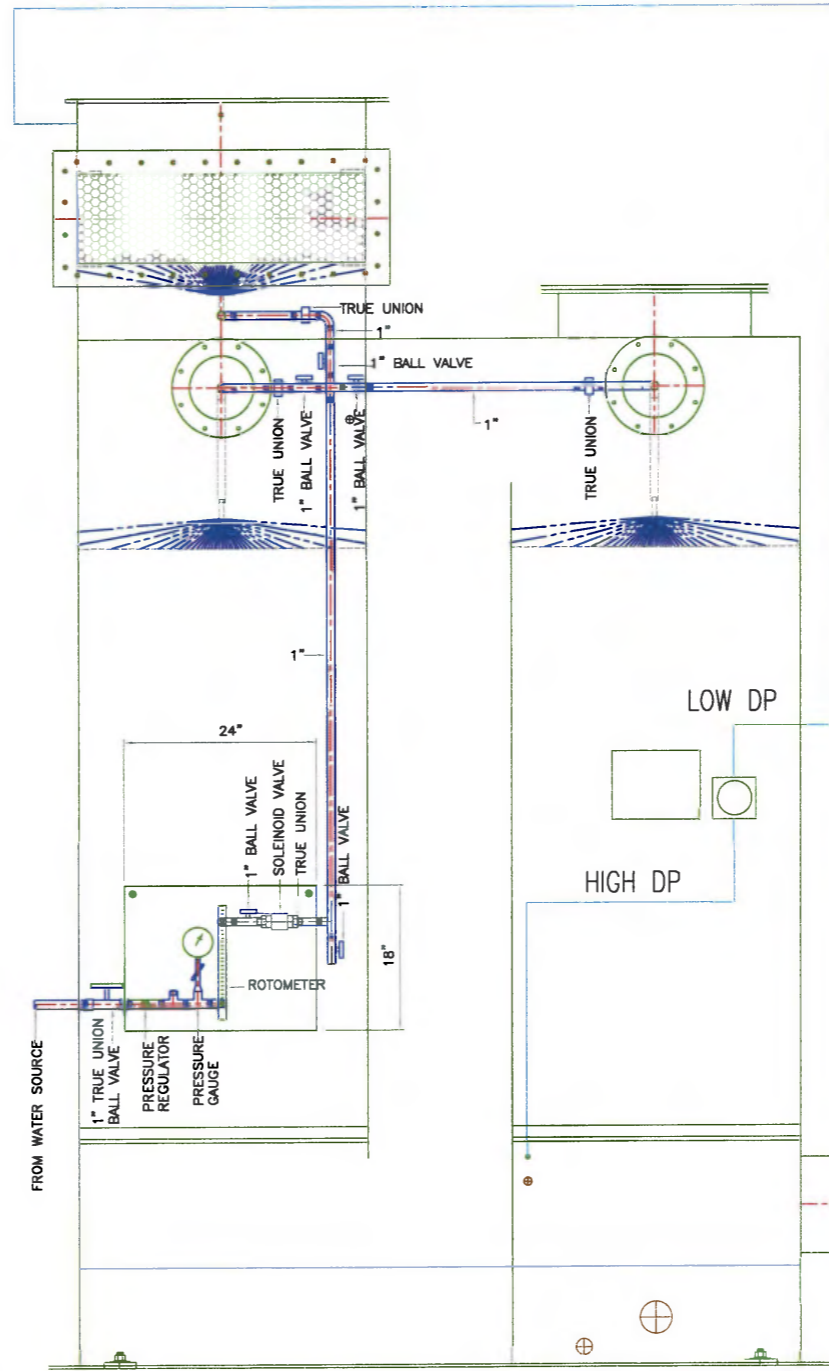

ELEVATION C-C

GENERAL NOTES

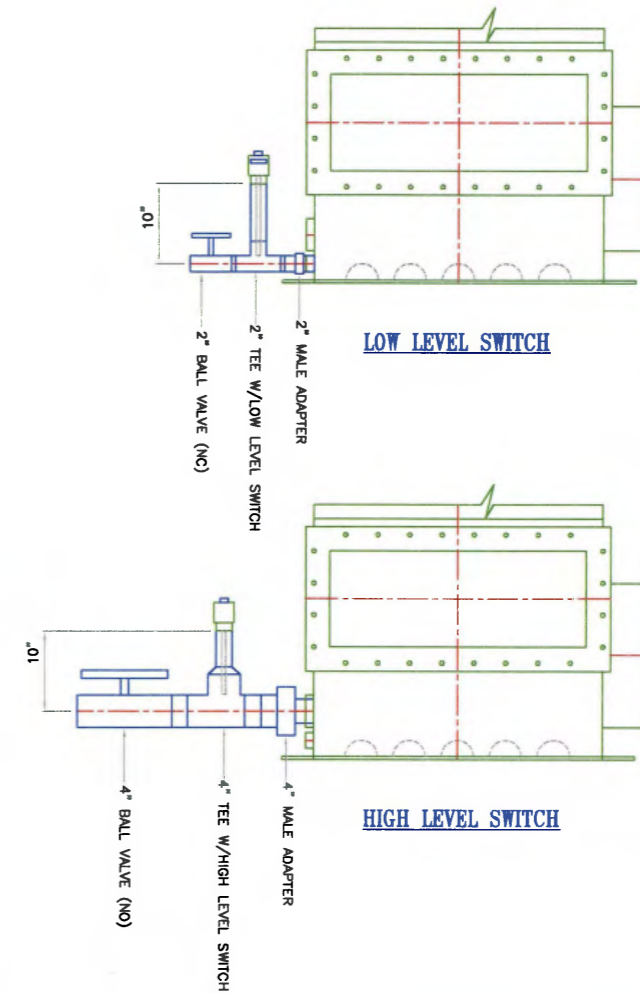

LOW LEVEL SWITCH

HIGH LEVEL SWITCH

100

1	REVISION	DATE	BY	CHKD
2	REVISION	DATE	BY	CHKD
3	REVISION	DATE	BY	CHKD

09-320 ANN ARBOR, MI

RAY PRODUCTS, INC
P.O. BOX 4809
EVANSVILLE, IN 47640
1-800-428-0130

FRP ODOR CONTROL SYSTEM
SPRAY HEADER SUPPLY & LEVEL SWITCH

DATE	TXG	PROJECT	09-320	09-320-OCW1-SH-01	1
------	-----	---------	--------	-------------------	---

NOZZLE SCHEDULE FOR OCU-1											
MARK NO.	QTY	CONNECTION TYPE	I.D./SIZE	O.D.	B.C.	# OF HOLES	HOLE DIA.	DRILLING PATTERN	LOCATION	ELEVATION	SERVICE
A	1	FLANGE	20"	24 3/8"	23"	20	1/2"	PS 15-69	180° - 44° OFF C. TOWARDS 270°	31"	AIR INLET
B	1	FLANGE	20"	24 3/8"	23"	20	1/2"	PS 15-69	CENTER	TOP	AIR OUTLET
C	1	SPIN-OFF	8"	-	-	-	-	-	0° - 33° OFF C.	TOP	MEDIA ACCESS
D	1	SPIN-OFF	8"	-	-	-	-	-	72° - 33° OFF C.	TOP	MEDIA ACCESS
E	1	SPIN-OFF	8"	-	-	-	-	-	144° - 33° OFF C.	TOP	MEDIA ACCESS
F	1	SPIN-OFF	8"	-	-	-	-	-	216° - 33° OFF C.	TOP	MEDIA ACCESS
G	1	SPIN-OFF	8"	-	-	-	-	-	288° - 33° OFF C.	TOP	MEDIA ACCESS
H	1	FULL CPLG - FNPT	2"	-	-	-	-	-	120°	4"	DRAIN
J	1	FULL CPLG - FNPT	1"	-	-	-	-	-	335° - 40 1/2° OFF C.	TOP	MEDIA SAMPLE PORT
K	1	FULL CPLG - FNPT	1"	-	-	-	-	-	335° - 33° OFF C.	TOP	MEDIA SAMPLE PORT
L	1	FULL CPLG - FNPT	1"	-	-	-	-	-	335° - 25 1/2° OFF C.	TOP	MEDIA SAMPLE PORT
M	1	-	-	-	-	-	-	-	300° - 33° OFF C.	TOP	GROUNDING ROD
N	1	FULL CPLG - FNPT	1/2"	-	-	-	-	-	160°	99"	D.P. GAUGE CONNECTION
P	1	FULL CPLG - FNPT	1/2"	-	-	-	-	-	160°	39"	D.P. GAUGE CONNECTION
Q	1	-	-	-	-	-	-	-	150°	60"	D.P. GAUGE BRACKET
R	1	-	-	-	-	-	-	-	240°	60"	NAME PLATE
S	1	-	-	-	-	-	-	-	20°	70"	LIFTING LUG
T	1	-	-	-	-	-	-	-	200°	70"	LIFTING LUG
U	1	-	-	-	-	-	-	-	200°	6"	LIFTING LUG
V	1	-	-	-	-	-	-	-	45°	-	ANCHOR SLEEVE
V	1	-	-	-	-	-	-	-	135°	-	ANCHOR SLEEVE
V	1	-	-	-	-	-	-	-	225°	-	ANCHOR SLEEVE
V	1	-	-	-	-	-	-	-	315°	-	ANCHOR SLEEVE

VESSEL SPECIFICATIONS			
	CORROSION BARRIER	STRUCTURAL LAYER	EXTERIOR LAYER
THICKNESS	100 MILS	212.5 MILS (MIN)	N/A
RESIN SYSTEM	VIPEL F010	VIPEL F737	N/A
COLOR	NATURAL	NATURAL	VALSPAR 5W-1 WHITE

GENERAL NOTES

- COLOR: VALSPAR 5W-1 WHITE
- TOTAL WALL THICKNESS: 0.3125"
- BOTTOM THICKNESS: 0.3125"
- TOP FLANGE THICKNESS: 0.500"
- APPLICATION OF GEL COAT W/UV INHIBITOR ON VESSEL EXTERIOR.
- — — — — DEPICTS KICK PLATE ORIENTATION.
- FOR LIFTING LUG DETAIL SEE DWG 09-320-LL-01.
FOR LIFTING ANCHOR SLEEVE SEE DWG 09-320-AS-01.
FOR VESSEL INLET FLANGE SEE DWG 09-320-OCU1-IF-01.
FOR VESSEL OUTLET FLANGE SEE DWG 09-320-OCU1-OF-01.
FOR HANDRAIL DETAILS SEE DWG 09-320-OCU1-HR-01.
- CORROSION BARRIER
 - NEXUS VEIL: 1 LAYER
 - 1.5oz MATT: 2 LAYER

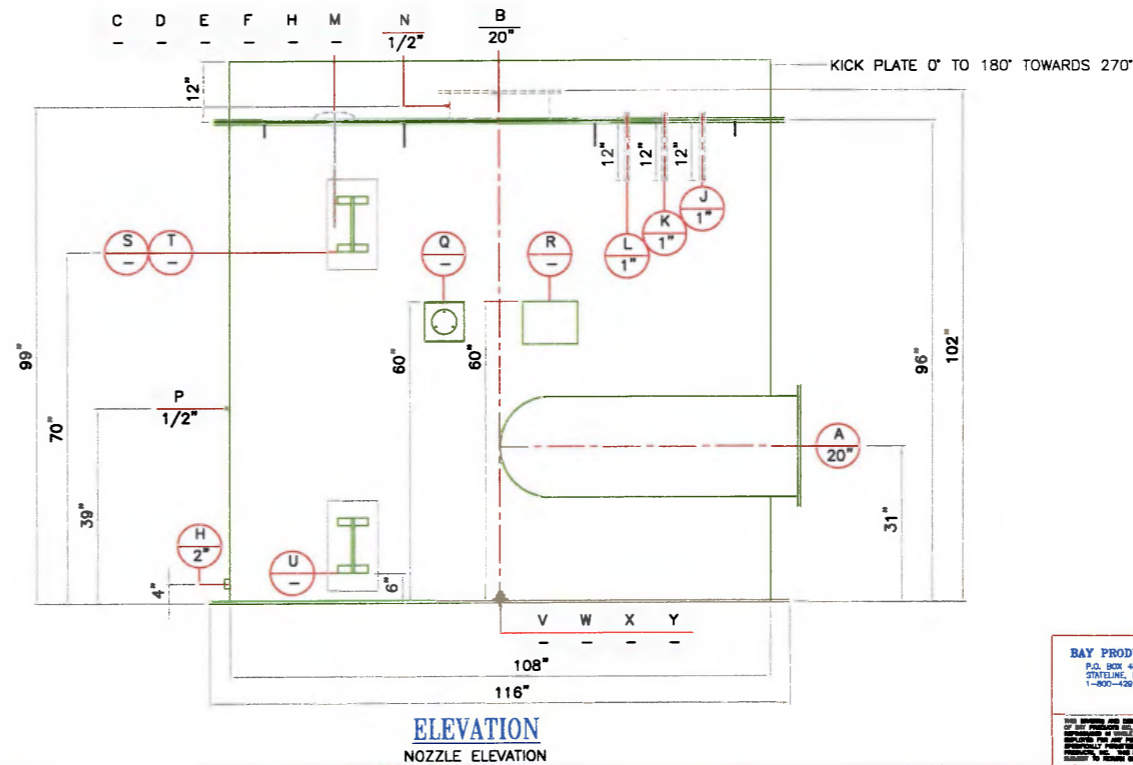
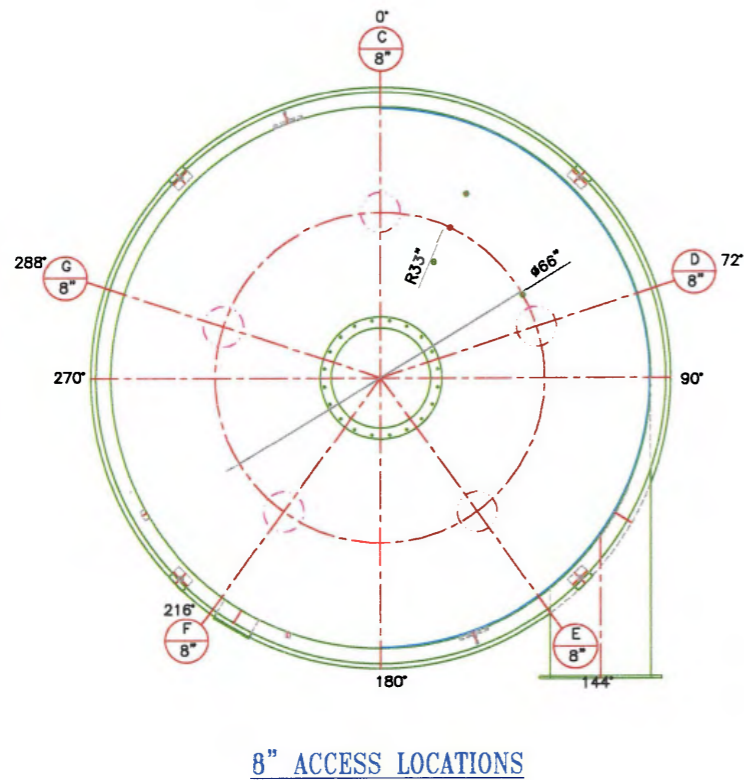
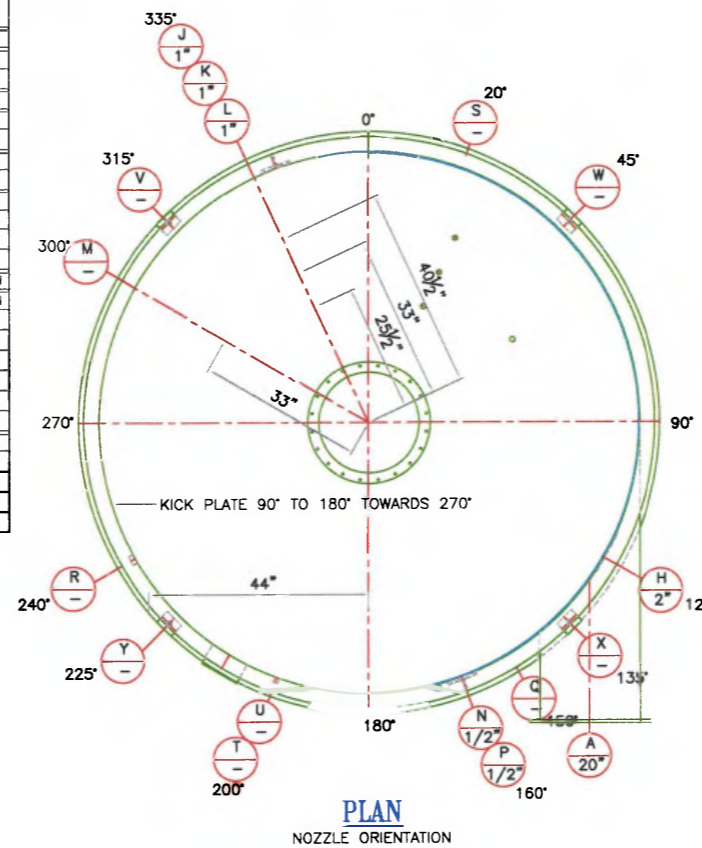

09-320 ANN ARBOR, MI			
BPI - TX			
FRP ODOR CONTROL SYSTEM RADIAL FLOW - OCU-1			
TKB			
09-320	09-320-OCU1-01		0

RAY PRODUCTS, INC.
P.O. BOX 4809
201E LANE, NY 05440
1-800-428-1150

Question # 10

Supporting Information

ODOR COMPLAINT SUMMARY 2015

09/30/15

DATE	TIME	CALLER	RESPONSE	SUPERVISOR	FINDINGS
01/13/15	9:07 a.m.	Towsley, [REDACTED]	9:15 a.m.	KES/JZ	Odor from soaking tub drain near bedroom and bathroom area. Recommend adding water to drains.
02/17/15	1:00 p.m.	Towsley, Mr. Spencer	1:05 p.m.	JM	Went to Towsley, did not find odor. Mr. Spencer said it smelled more like garbage than sewage.
04/09/15	9:20 p.m.	Towsley, Mr. Spencer		LR	LR found four exhaust fans running in the SHB truck load out garage, did not smell odor but shut fans off. Called Mr. Spencer back at 10:20 p.m.
04/13/15	9:42 a.m.	Towsley, Mr. Spencer	9:55 a.m.	JZ	DP and JZ went to both Towsley Dr. and Starks Blvd. Odors seem to be coming from AA Township lift station. Was referred to AA Township, Rick Judkins to follow up with Mr. Spencer.
04/14/15	6:50 a.m.	St. Joseph Hospital, [REDACTED]	7:00 a.m.	LR	AW and RB went and found dead deer smell by river but nothing from plant.
04/29/15	7:50 a.m.	St. Joseph Hospital, [REDACTED]	8:00 a.m.	LR	Cake truck had loaded before 7:00 a.m. AW went to hospital and found no odor, reported back to JM.
05/01/15	2:24 p.m.	Email to EK/Eastwood Terrace Apts.	2:35 p.m.	JZ	JZ and MK observed location and found strong fertilizer being applied to fields nearby. Called office and spoke with Ms. DeTavernier at 3:45 p.m.
05/08/15	7:15 a.m.	St. Joseph Hospital	7:35 a.m.	CA	Inspected hospital grounds, parking lot, spoke with several people. No odor detected.
06/24/15	7:50 a.m.	St. Joseph Hospital, [REDACTED] Numerous odor complaints	8:10 a.m.	CA	CA and AW inspected hospital grounds and spoke with nurses outside. No odors detected.
07/06/15	2:26 a.m.	St. Joseph Hospital, [REDACTED]	2:15 a.m.	CA	CA did not notice any odors out of the ordinary. FP closed all the doors on the SHB.
07/09/15	11:32 p.m.	St. Joseph Hospital, [REDACTED]		KW	Odor from 9:15-10:15 p.m. but reported after the fact. NJ and TK noticed odor at plant around 8:45 p.m. Running centrifuge that night.
07/20/15	5:55 p.m.	Towsley, Mr. Spencer	6:00 p.m.	JZ	Inspected AA Township lift station, no odor detected. Lighter fluid odor two doors down from Spencer's.
07/22/15	7:30 a.m.	St. Joseph Hospital, [REDACTED] Complaints from other individuals	7:35 a.m.	TG	JP and JD went to hospital and observed no odor out of ordinary.
08/02/15	5:00-5:10 p.m. MULTIPLE	Towsley, Mr. Spencer and two others	5:05 p.m.	JZ	Went by AA Township lift station, immediately smelled septic wastewater odor while standing in the roadway by the station and on top of the station itself. Drove over to Towsley Drive, smelled same odor as the road went downhill in elevation. Received multiple complaints from Towsley as of 7:45 p.m. Left two voicemail messages on Rick Judkins' cell phone.
08/16/15	2:15 p.m.	Towsley, [REDACTED]	2:25 p.m.	JZ	JZ and JP smelled slight odors by AA Township lift station and sanitary manhole covers.
	5:15 p.m.	Towsley, [REDACTED]	5:15 p.m.		AA Township also notified.
09/01/15	1:05 p.m.	Towsley, Mrs. Spencer	1:15 p.m. 3:05 p.m.	JM	JM, JP and DMC went to AA Township lift station and Towsley, did not smell odor. Went back out on second call, noticed intermittent and brief raw sewage smell when slight breeze picked up. Not sure of source, need joint investigation to determine.
09/06/15	4:35 p.m.	Towsley, Mr. Spencer	4:40 p.m.	JM	JM went to AA Township lift station and Towsley. No odors found.
09/07/15	2:30 p.m.	Towsley, Mr. Spencer		JM	JM and MK went to AA Township lift station and Towsley. No odors found.
09/08/15	2:00 p.m.	Towsley, Mrs. Spencer	2:00 p.m.	JZ/CA	JZ and CA went to AA Township lift station and found no odor. Went to Towsley, smelled intermittent and brief stagnant water odor. Mrs. Spencer mentioned floodplain or swamp west of property and masking agent smell.
09/10/15	7:50 a.m.	[REDACTED] St. Joe Hospital	8:00 a.m.	TG	KS and TG went to hospital and found no odors. Noticed odor by WCC Fitness Center on way to hospital. Investigated on the way back but no odors found.
09/15/15	3:45 p.m.	Missed call from Towsley, Mr. Spencer		TG	Called Mr. Spencer to apologize for missed call, no odor problem at this time. Asked him to call if it happens again.
09/16/15		Noticed and returned missed call			
09/17/15	5:04 p.m.	Towsley, Mr. Spencer	5:10 p.m.	CA	CA and MK went to Towsley and did not smell odor. Only noticed smell of freshly cut grass at time.
09/18/15	7:20 p.m.	Towsley, Mr. Spencer	7:50 p.m.	JM	JM went to AA Township lift station and Towsley, found no odor.
09/21/15	11:16 p.m.	St. Joseph Hospital, Mr. Williams	11:20 p.m.	KW	KW and TK went to hospital, found stagnant or grey water odor at entrance of hospital. Went around hospital, did not find odor in other locations. Returned to plant at midnight, noticed similar odor by the West Plant primary and secondary tanks (new West Plant not yet in service).
09/28/15	10:05 p.m.	Towsley, Mr. Spencer	10:20 a.m.	JZ/KS	KS and JZ went to Towsley and AA Township lift station, only smelled lawn chemical from truck spraying grass that dissipated further down the road. Walked areas adjacent to plant, smelled briefly odor of raw wastewater near #11 primary tank. By the time they walked by #12 tank and in other direction, could not find odor.
10/1/2015	9:00 a.m.	Meeting with [REDACTED] and [REDACTED] from Towsley along with [REDACTED] and [REDACTED] from Ann Arbor Township concerning odors. Discussed concerns, where we have been on odors and changes, set meeting for next year.			
10/8/2015	1:15 p.m.	[REDACTED] 1175 Towsley Lane		JM	JM/JC went to investigate found no odors. AV guy on site says he is there 8-9 times a year and has smelled it. All three smelled nothing at this time and walked around the entire property.
10/11/2015	6:35 p.m.	Towsley, Mr. Spencer Towsley, Mr. Tim Johnston	6:45 p.m.	JZ	JZ/TK left WWTP, got a whiff on driveway before bridge. We drove slowly down Towsley. We could not smell anything as we went passed 1267. We slowly continued down Towsley and TK caught a light, momentary wiff of a H2S / raw wastewater smell in front of Mr. Spencers driveway. I did not smell it. We went the rest of the way down Towsley and

neither of us smelled anything further.

10/11/15	10:10 p.m.	Towsley, Mr. Spencer	10:15 p.m.	KW	KW and TK drove entire length of Stark Strasse, no odors. Halfway to Mr. Spencer's got a smell of odors, stopped vehicle and got out to tracksource of the odor. However, the odor was gone as quick as it was detected. Drove the rest of road and stopped and walked around the Spencer property along the roadway. There was no air movement.
10/14/2015	3:40 p.m.	Mr. Spencer at St. Joe's Hospital	3:50p.m.	JM	JM and AW went to hospital to investigate terrible odors at the hospital entrance. They could not smell anything. Also, drove around the entire St. Joe complex still no odors found. Did smell a freshly killed skunk in the road on Dixboro just north of Huron River Drive.
10/20/15	11:00 p.m.	Towsley, Mr. Spencer	11:20 p.m.	KW	KW and NS investigated could only smell wet leaves at it had rained earlier. property, a strong odor of fertilizer was present. This extended about 30 yards past Mr. Spencer's property. There were not any sewage or ammonia odors present on Towsley Lane.
10/21/2015	3:55 p.m.	Towsley, Mr. Spencer	4:10 p.m.	JZ	JZ/JP drove down the road with windows open and could not smell any raw wastewater smell. We encountered Mr. Spencer walking along Towsley Lane near the wooded lot. JP and I got out of the truck and meet Mr. Spencer when he got in front of 1234. While talking to him there, he would occasionally state "there it is, can you smell it now". The smell appeared intermittent to him. JP and I could not smell anything.
10/24/2015	11:47 a.m.	Towsley, Anne Orringer		JZ	Mr. Orringer said he was out for his daily walk along Towsley and could smell something in the "valley" area. I asked if it was a constant odor throughout the area or if it was localized. He said it was localized in front of Mr. Spencers house along with at the base of the hill. He stated he usually can detect the odors on calm no wind days like today. JZ only one at WWTP so checked WWTP found no sources of odors.
11/4/2015	11:25 p.m.	2973 West Clark Road, Deloras	11:35 p.m.	TG	TG and DMC took a company vehicle and a gas detector out to the location. We circled the area several times and also circled through St. Josephs hospital and could not detect any odor.
11/10/2015	7:10 p.m.	2973 West Clark Road, Deloras	7:20 p.m.	JZ	Deloras called stating she was smelling a strong odor of sewage in the air since 4pm this afternoon and that she could smell it as she crossed over the Dixboro bridge a few hours ago. She said she had been told to call us when she smelt anything. I got in the van and drove to the apartment complex which is located on the other side of St. Joes hospital. I had the window open during the drive and could not smell any unusual odors on the drive.
11/14/2015	11:05 p.m.	Towsley, Mr. Spencer	11:15p.m.	TG	Mr. Spencer reported that after returning home from an evening out that he could smell what he described as a terrible, rancid, rotten egg smell and that it is disgusting. TG & NJ traveled to the area to investigate the reported odor. They drove up and back down Towsley Lane but could not detect any odors. All of the doors at the plant were closed and there was no obvious smell coming from anywhere in the plant.
11/25/2015	7:36 a.m.	Deloras		JM	I have recently started moving to the Ann Arbor area and purchased a home near St. Joe's Hospital. Since that time it has come to my attention that the wastewater treatment plant nearby gives off an intolerable odor on many days, and the wind blows it either toward the hospital or toward the neighborhood that I now live in. This is extremely distressing. Can you please advise me on the situation with the sewage plant and what is being done to address this terrible issue
11/29/2015	5:30 p.m.	Ms. DiPietro	5:35 p.m.	JM	She stated that she wanted to make sure that this call was logged. I assured her that I would log it. I drove down by the dam and got out of the truck and walked around the area. I could not smell anything.
12/11/2015	10:00 p.m.	2973 West Clark Road, Deloras	10:05 p.m.	TG	Dolorus called and indicated that while driving home at 9:10 p.m. she could smell a strong odor of sewage after turning onto Dixboro road and had that odor all the way home to her address on West Clark road. I told her that I would go out and investigate the problem and thanked her for her call. She indicated that she would keep calling until this problem is fixed. I took a company vehicle and a gas detector out to the location. I circled the area several times and also circled through St. Joe's hospital and could not detect any odor.
12/14/2015	1:40 p.m.	1267 Towsley, Ms. Lowe	1:50 p.m.	JM	JM/NN responded to call that Ms. Lowe could smell sewer. I told her that I would investigate it. She told me that she wanted the call documented and I assured her that it would be. Verified all plant doors closed and no odors on site. Drove to Ms. Lowe's only odor identified while walking around her property were the 2 large pines trees in front of her home
12/23/2015	9:19 a.m.	Ms. DiPietro		CE investigated	Ms. DiPietro reported a "very strong odor" while crossing the Dixboro Road bridge over the Huron River. There were no odors in the area of the bridge but there were sweet smelling odor in the area of the Heartland Health Care Nursing Home on E. Huron River Drive. There were some odors at the Raw Sewage Lift Station and along a portion of the Railroad track swale west of the Lift Station. However, that odor did not reach the area of the Dixboro Bridge at the time of this odor investigation. All of the doors at the plant were closed and there was no obvious smell coming from any other location at the plant.
12/28/2015	10:54 a.m.	Ms. DiPietro	11:05 a.m.	JM	Ms. DiPietro reported to Deloras that there was a terrible raw sewage smell as she was driving over the Dixboro bridge. After verifying that all of the plant's doors were closed (and they were) JM toured the plant to try to detect any odors. JM could not detect any odors outside of any of the buildings. Then JM drove across the bridge and back with the windows open. JM could not smell anything on either pass across the bridge.

ODOR COMPLAINT LOG 2016

DATE	TIME	CALL FROM	PHONE NUMBER	SUPERVISOR	COMPLAINT	RESPONSE/INVESTIGATION RESULTS	WIND
1/4/2016	12:48pm	Della DiPietro	248-534-5830	[REDACTED]	Terrible raw sewage smell while driving over Dixboro Road bridge	Responded immediately. Wind blowing toward plant from bridge as evidenced by snowfall direction. No unusual odors found at the plant or on the bridge.	N 8 mph
1/5/2016	7:50am	Dwight St. Joe Mercy Hospital	734-712-3375	[REDACTED]	Dwight was informed of a sewer smell at the hospital. Did not know where at the complex.	Left WWTP immediately. Walked path along river from WCC to east hospital entrance. Drove around entire complex. No odors detected. Cake truck loaded from 5:45-7:00am with doors closed. No unusual odors present at plant or from cake loading.	0 mph
2/1/2016	8:45pm	Corey St. Joe Mercy Hospital	734-712-4090	[REDACTED]	Corey was informed of sewer smell at hospital. He had smelled it by powerplant near the laboratory area.	Left plant immediately. No odors noticeable at WWTP. Walked around the powerplant area and the entire hospital perimeter several times. No odors detected	0 mph
3/18/2016	8:34am	Don St. Joe Mercy Hospital	734-712-4090	[REDACTED]	Don reported strong open sewer smell.	7:50am cake truck arrived to load. No odors detected when we left plant. Walked from WCC to east hospital entrance, no odors detected. Drove around perimeter, found slight odor on NE side of hospital that quickly dissipated. Found manhole in grass N of hospital road, open sewer smell downwind of manhole. Will check when future complaints are received.	0 mph
3/20/2016	9:00pm	Deloras 2973 Clark Rd	734-645-7043	[REDACTED]	Deloras reported that she could smell sewer at her residence (Eastwood Terrace Apartments).	Immediately left WWTP. No odors found at apartment. Asked another resident if they has smelled anything. They reported they had been in and out several times and had not smelled any odors.	0 mph
3/30/2016	9:20am	Della DiPietro	248-534-5830	[REDACTED]	Della reported odor on north side of Dixboro bridge.	Left immediately and took Oda Logger. Meter read zero for entire travel time. Saw four people at park lot under bridge, they had been there for 30 minutes and had smelled nothing while there.	ENE 0-6 mph
4/14/2016	11:30pm	Deloras 2973 Clark Rd	734-645-7043	[REDACTED]	Reported sewer smell lasting 30 minutes from Dixboro Road bridge all the way to her residence.	Left immediately and took a gas meter. Meter read zero for all parameters. Only odor found was a skunk smell in in the apartment complex. At WWTP all doors closed, faint sewage odor at retention building. 20 yds away no odors.	0 mph
4/18/2016	1:54am	Deloras 2973 Clark Rd	734-645-7043	[REDACTED]	Reported sewer smell at residence. So strong she had to close her windows.	Left immediately and took a gas meter. Meter read zero for all parameters. WWTP had all doors closed and no unusual odors detected.	0 mph
4/18/2016	8:30am	Dwight St. Joe Mercy Hospital	734-712-4090	[REDACTED]	Reported odor	Checked plant for odors. None detected on gas meter. 8:45am left plant checked all around hospital. Gas meter read zero for all parameters. Cake truck left site five minutes after call came in.	0 mph

6/25/2016	9:16pm	[REDACTED] 2973 Clark Rd	734-645-7043	[REDACTED]	Reported strong sewage odor while crossing Dixboro Road bridge.	Message left on cell phone, returned call as soon as cell service was obtained after coming out of WWTP buildings. Left immediately and took a gas meter. Noted sewage odor next to Retention Building and meter read 2.0 ppm for H2S at WWTP gate on way out. Stopped at several places on way to and on Dixboro Road bridge, did not find any odors and meter read zero for all parameters. Did not find any odors on return trip to WWTP and meter read zero for all parameters, including at WWTP gate. All WWTP doors were closed and no unusual odors.	0 mph
7/11/2016	8:28am	[REDACTED] WCC	via Cityworks	[REDACTED]	Reported strong sewer gas smell permeating the air around campus between 6:30-7:00am	Left @8:42am with Oda Logger, found no odors and meter read zero for all parameters. WWTP doors were closed, slight odor within 20 yds of Screen & Grit Building only.	0 mph
8/24/2016	7:18am	[REDACTED] St. Joe Mercy Hospital	No number	[REDACTED]	Reported receiving sewage smell complaints for past two days.	Message left on cell phone @7:18am, heard about 9:00am. Left @9:05am and drove around St. Joes with windows down. No odors detected in the plant, on the way to St. Joes, or on road surrounding the hospital. Spoke with two people jogging and another cutting the grass, none had smelled any odors. All WWTP doors were closed and no unusual odors.	N 3 mph
9/9/2016	11:50am	[REDACTED]	248-534-5830	[REDACTED]	Reported strong sewer odor along N. Dixboro.	Left immediately with gas meter. Did not find any odors and meter read zero. Spoke with three people fishing at Geddes Dam for past two hours, none smelled any odors. Closed one door on Raw Sewage Lift Station after it was found to be open.	NE 0-5 mph
9/15/2016	12:40pm	[REDACTED]	248-534-5830	[REDACTED]	Reported smelling strong sewer odor for past 20-25 minutes along N. Dixboro Road. Told her I'd be right out to investigate & offered to meet her where she was smelling odor. She declined and asked if I was recording this complaint; I told her I was.	Left with gas meter @12:45pm, smelled nothing out of the ordinary exiting the plant, along Dixboro Road, or returning to the plant. Walked around the foot of her driveway with gas meter, which detected nothing. Spoke with person eating lunch in car parked on other side of the RR tracks downstream of the dam. She said she had been there 15-20 minutes and smelled no odors. Closed one door on Screen & Grit Building after it was found to be open; walked through S&G and on Retention Building roof with the gas meter and detected nothing.	W 8 mph

9/21/2016	8:20am	[REDACTED] WCC	via Cityworks	[REDACTED]	Reported air has a fecal matter odor to it.	Left @8:35am to investigate campus, spoke with grounds keeper who said he had been out all morning and had not smelled any sewer/fecal matter odors. Walked the path between the hospital and fitness area of WCC, noted odor of lime stabilized biosolids within 15 yds of observation deck only. Went around entire campus and hospital, no other odors found. Only open doors at WWTP were truck bays to load lime stabilized biosolids. No odors present at the plant before or after the odor complaint was filed.	0 mph
9/25/2016	7:00pm	[REDACTED]	248-534-5830	[REDACTED]	Reported smelling sewage while driving south on Dixboro Road at Geddes Road.	Left immediately with gas meter. Did not find any odors at intersection of Dixboro Road and Geddes Road; gas meter detected nothing. Location of the odor complaint was upwind of the WWTP. One alcove door was open at Screen & Grit Building, no odors detected.	N 5 mph
9/27/2016	11:14pm	[REDACTED]	via Cityworks	[REDACTED]	Reported strong sewer smell while driving over Dixboro Road bridge with windows up.	Left immediately and took the gas meter. Found strong skunk odor at south end of the bridge only, gas meter read zero for all parameters. All WWTP doors were closed and no unusual odors.	0 mph
9/28/2016	12:20pm	[REDACTED] WCC	via Cityworks	[REDACTED]	Reported moderate odor.	Left immediately with gas meter and drove around campus. Asked two students if they had smelled anything, both said they had not. Gas meter detected nothing along Huron River Drive or around campus. All WWTP doors were closed and no unusual odors.	NNE 3 mph
10/5/2016	7:20pm	[REDACTED]	248-534-5830	[REDACTED]	Reported sewage smell on on N. Dixboro Road.	Left immediately with gas meter. Found light wastewater odor coming across bridge to intersection of Dixboro Road and Geddes Road. Stopped on north end of Old Dixboro Road and at park entrance by Geddes Dam, did not find any odors; gas meter detected nothing. Found slight wastewater odor on roof of Retention Building; all hatches were closed.	0 mph
10/13/2016	10:00pm	Anonymous	via Cityworks	[REDACTED]	Reported smell of rotten eggs/sewer gas at Whole Foods Market, 3135 Washtenaw Ave. Stated odor has been going on since summer.	Left @11:20pm, drove around Whole FoodsMarket with gas meter. Did not find any odors as described. One alcove door was open at Screen & Grit Building, no odors found.	0 mph
10/14/2016	7:20am	[REDACTED] St. Joe Mercy Hospital	734-712 3456	[REDACTED]	Indicated a person reported odor on SE side of the hospital complex.	Left @7:35am, drove around hospital. Did not find any sewage odors; did find organic odor between the hospital and the natural area between the bike path and the road. Also found musty organic odor from nearby farm. One alcove door was open at Screen & Grit Building, slight odors present downstream of headworks.	0 mph
10/19/2016	9:00am	[REDACTED] St. Joe Mercy Hospital	734-712 3456	[REDACTED]	Reported wastewater odor by the Materials Center.	Left immediately with Oda Logger, stopped several times on road around St. Joes. Got to Materials Center @9:15am, walked around entire area with meter and only odor found was freshly cut grass. All WWTP doors were closed and no unusual odors.	0 mph

11/6/2016	7:10pm	[Redacted]	248-534-5830	[Redacted]	Reported smelling something bad on North Dixboro Road by the bridge. Asked if odor was a raw wastewater, septic or chemical smell; she said she did not know, just that it was strong and smelled "real bad". I told her I would investigate. She said to make sure I documented her call.	Left immediately with gas meter. Drove across the bridge to the north side with the windows open. Walked on north end of bridge and near the park entrance by Geddes Dam. Did not find any odors and gas meter did not detect anything. All WWTP doors were closed and no unusual odors.	0 mph
11/7/2016	7:10pm	[Redacted]	248-534-5830	[Redacted]	Reported smelling bad on North Dixboro Road by the bridge. Says prevented working outside. Says no one answered phone and no one called back.	WUS says never received call, call logs also show no calls.	Not available
11/9/2016	7:16pm	[Redacted]	248-534-5830	[Redacted]	Reported smelling something bad on North Dixboro Road by the bridge. I told her I would investigate. She said to make sure I documented her call.	Left immediately with gas meter. Drove across the bridge to the north and down to the park entrance by Geddes Dam with the windows open. Did not find any odors and gas meter did not detect anything. All WWTP doors were closed and no unusual odors.	S 2 mph
11/15/2016	9:30am	Anonymous	via Cityworks	[Redacted]	Smell of rotten eggs that permeates buildings at WCC - strongest before 8:00am.	Left at 9:45am with Oda Logger, drove around WCC lots with windows open. Did not find any odors and gas meter did not detect anything. Walked around the area with Oda Logger, same results. All WWTP doors were closed and no unusual odors.	S 3 mph
11/16/2016	6:48pm	[Redacted]	734-657-1420	[Redacted]	Caller reported smelling odor on North Dixboro Road by the bridge.	Left at 7:02pm with Oda Logger, drove to north end of Old Dixboro Rd. and walked length of bridge south with meter. Smelled raw sewage on north side of bridge. Oda Logger detected nothing. Upon return checked EQ/Retention wastewater smell, not any stronger than usual.	S < 1 mph
11/16/2016	7:41pm	[Redacted]	248-534-5830	[Redacted]	Caller reported smelling odor on US23 N ramp at Geddes Rd. as well as area reported by Hupy.	Received call while typing up previous report, informed that bridge area had just been checked.	S < 1 mph
11/22/2016	8:25pm	[Redacted]	248-534-5830	[Redacted]	Caller reported bad smell on N Dixboro Road by the bridge. I told her I would investigate, she said to make sure I documented her call.	Left at 8:35pm with gas detector from SHB with John Craig, neither of us could smell anything, nor could gas detector detect anything at bridge location. Also checked park entrance by dam and drove back with windows open. Both detected nothing, JC drove through the same area at time of call reported nothing at that time as well. Returned and checked doors at S&G and SHB. All closed.	0 mph
11/27/2016	7:57pm	[Redacted]	248-534-5830	[Redacted]	Caller reported bad smell in center of N Dixboro Road bridge. I told her I would investigate, she requested her complaint be logged.	Left around 8:05pm with gas detector from SHB, checked doors at SHB, all were closed. Drove across bridge slowly, detected no smell, nor by dam or on the way back. Detector also detected nothing.	SSE 5 mph
11/30/2016	7:22am	[Redacted] St. Joe Mercy Hospital	734-712-3456	[Redacted]	Caller reported someone else noted an odor near the outpatient surgery center.	Keith and Jeff went out at 7:30am. Drove around hospital and got out at several places. Oda-logger detected no H2S. Several places we smelled an unknown organic scent. Very slight. One location had "chemical" scent, like porta-potty. All plant doors were closed.	N 0 mph Few gusts.

ODOR COMPLAINT LOG 2017

DATE	TIME	CALL FROM	PHONE NUMBER	SUPERVISOR	COMPLAINT	RESPONSE/INVESTIGATION RESULTS	WIND
2/24/2017	6:05pm	[REDACTED] (voice message)	248-534-5830	[REDACTED]	Smelled sewage odor while driving over Dixboro Road bridge at the top of the hill	Responded within 15 minutes. No odors observed or detected by meter at top of the hill. No odors observed or detected by meter at manholes on north side of river near the dam.	0 mph/Calm
7/4/2017	6:06pm	[REDACTED] (voice message)	248-534-5830	[REDACTED]	Smelled sewage odor at north end of Dixboro Road bridge at the top of the hill on 7/3/17 and while kayaking on the river on 7/4/17.	Responded within 15 minutes. No odors observed or detected by meter at top of the hill. No odors observed or detected by meter at manholes on north side of river near the dam.	0 mph/Calm
7/4/2017	6:21pm	[REDACTED] voice mail	248-534-5830	[REDACTED]	Smell was coming from the top of the hill on N Dixboro at her home on 7/3/17. She also stated that she smelled sewer while kayaking on the river on 7/4/17.	NF and Anderson took gas meter to location of odor complaint. No odors observed or detected by meter. Proceeded to the dam on N Dixboro w/gas detector, checked manholes, no odors observed or detected by meter. or detected by meter. or detected by meter. or detected by meter.	0 mph/Calm
7/23/2017	8:57pm	[REDACTED] (voice message)	248-534-5830	[REDACTED]	Smelled sewage odor on side of her house down toward the river.	Responded within 35 minutes. Spoke with Mr. and Mrs. DiPietro, they could no longer smell the odor. No odors observed or detected by meter from the house to about 200 feet toward the river.	0 mph/Calm
8/1/2017	8:46pm	1102 Townsley (text)	734-395-0212	[REDACTED]	Absent from report	Went to location with gas meter, no odor observed or detected by meter, asked people at location if they smelled anything as well and they had not. Checked air at a few storm drains but meter detected nothing. Left a voicemail.	14 mph SW
8/10/2017	8:11am	4800 Huron River drive.	Cityworks	[REDACTED]	Mild sewer gas smell	Went to location, no odor observed or detected by meter, talked to members of the public and they noted the same.	0 mph/Calm
8/29/2017	6:37pm	[REDACTED]	248-534-5830	[REDACTED]	Odor on west side of US 23 overpass on Geddes Rd. Strongest on west side of overpass near Concordia, but detectable on east side as well.	Went to location. No odor observed or detected by meter.	0 mph/Calm
9/1/2017	11:30am	[REDACTED]	248-534-5830	[REDACTED]	Faint smell reported on the bridge over the river.	Went to location. No odor observed or detected by meter.	4 mph SSE
9/1/2017	8:30pm	[REDACTED]	248-534-5830	[REDACTED]	Smell on US 23, noticed as she was driving.	Observed odor from Retention Building until passing over the bridge but could not smell it on US 23, Old Dixboro, New Dixboro, or Geddes.	7 mph ENE
9/2/2017	11:00am	[REDACTED]	248-534-5830	[REDACTED]	Smell on Dixboro Bridge over the river.	Went to location. No odor observed or detected by meter. Smelled faint odor as driving back, at or near the Retention Building.	1 mph NNE
9/10/2017	6:35pm	[REDACTED]	248-534-5830	[REDACTED]	"Sewer smell" on US 23 near Geddes Rd.	Went to location with windows down, no odors observed or detected by meter. Asked person arriving for work if he smelled anything and he said he did not.	0 mph/Calm
9/10/2017	9:03pm	[REDACTED]	734-678-3052	[REDACTED]	"Sewer smell very bad" at Dixboro & Geddes	Went to location @9:20pm, observed a brief odor on the way. Called called Mr. Kade when they reached his driveway and spoke with him directly. He said that he still smelled the odor and it was a "a burning smell that he could feel in his lungs." Told him that we do not burn anything at the WWTP. Afer meeting, walked up and down the street in attempt to observe odors. Only odors of note were the smell of the river by the dam and a wood-like odor about halfway between Mr. Kade's home and the dam. Manholes along Dixboro	0 mph/Calm

						had no observable odors coming from them and could not detect anything by meter. While returning to the plant, again noticed the musty smell to the plant we again noticed the musty smell near the intersection of Dixboro & Huron River Drive.	
9/11/2017	10:00am	4800 Huron River Drive	Cityworks	[REDACTED]	"Sewer gas small parking lot 4"	Went to location. No odor observed or detected by meter. Talked to group of employees of employees setting up a tent and they stated they had not smelled anything all morning.	2 mph ESE
9/12/2017	9:40am	[REDACTED] 121 N. Dixboro	None provided	[REDACTED]	Smelled strong odor	Drove to Mr. Kade's residence, observed strong smell at plant gate but not elsewhere. Talked to Mr. Kade and he said the smell had dissipated but was strong earlier. Explored area with gas meter and detected nothing. Mr. Kade also mentioned chemical smell over the weekend and we informed him the plant access road was repaved then. Offered him a tour to track down or identify the odors he smelled to see if it was coming from a plant process.	4 mph N
9/14/2017	8:43am	[REDACTED]	None provided	[REDACTED]	Smell like it coming from sewer plant	Went to location with KES to investigate. KES walked the river path, no odor observed. Drove through parking lots and looped around hospital, no odor observed or detected by meter.	0 mph/Calm
9/22/2017	11:10pm	[REDACTED]	906-399-3146	[REDACTED]	Foul and slightly metallic smell around house like cow manure but worse	Went to location, no odor observed or detected by meter. Checked manholes up and down the down the road including those along N Dixboro. Only odor observed was the smell of the river by the dam Asked person fishing if he noticed a foul smell and he said he had not.	0 mph/Calm
9/23/2017	9:10am	[REDACTED]	734-657-1420	[REDACTED]	Craig Hupy called & said he could smell the plant from the fitness center next to St. Joe's Hospital. He said it smelled like he was standing in the middle of the plant.	Went to fitness center, no odors observed or detected by meter. On way back to plant, smelled raw wastewater adjacent to the Retention Building inside the plant. Noted a light raw wastewater odor at like that near the Retention Building at Dixboro Rd and Huron River Dr while driving into work that morning.	0 mph/Calm
10/6/2017	10:00am	[REDACTED]	None provided	[REDACTED]	smelled a strong odor	Weinman & KES noticed no odors near retention bldg near plant gate. At the intersection of Huron River Dr, KES could smell light sewage odor. Headed N on Dixboro and odor quickly went away. Investigated the bridge/dam and asked pedestrian if he could smell an odor & he could not. Odor continue to linger at intersection of Huron River Drive. Odor were notice near manhole (non-vented) on Old Dixboro. Possible increase in flow the plant is receiving today due to rain water/infiltration water pushing gasses up causing odors to be more prevalent.	0 mph/Calm
10/8/2017	6:45pm	[REDACTED]	248-534-5830	[REDACTED]	Odor reported on Dixboro over bridge	Noticed some odor in plant from the Retention Building. Caught brief smell on Dixboro Rd, nothing detected by meter. Pedestrians walking smelled brief light odors periodically on previous walks. Screen & Grit door was partially open due to H2S build-up in the alcove. Wrote work order for alcove air fan problem to be fixed. After investigation drove around Screen & Grit, no odor observed.	0 mph/Calm
10/10/2017	2:20pm	[REDACTED]	None provided	[REDACTED]	Sewer smell at her home and driving over the bridge on Dixboro	Went to go investigate, noticed a slight odor over Dixboro bridge that did not last very long. At 121 Dixboro, observed typical fall odors like decaying leaves and damp wood. No odors observed at the dam. Asked citizens if they smelled anything in the last hour and they said they had not. Noticed slight sewage smell over Dixboro bridge and at the intersection of Dixboro Rd & Huron River Dr,	0 mph/Calm
10/12/2017	6:40pm	[REDACTED]	734-657-1420	[REDACTED]	Mr. Hupy said he could smell the plant from the fitness center next to St. Joe's Hospital	Noted strong odor from Retention Building inside plant outside of the Administration Building. Drove to fitness center with window open Noticed a light smell like the Retention Building at the intersection of Huron River Dr & Dixboro. No odor observed at fitness center. On way back to plant, did not observe odor noticed a few minutes prior. Off site odors appear to be intermittent.	NW 2.0 mph
10/21/2017	8:45pm	[REDACTED]	734-678-3052	[REDACTED]	Sewer smells on Dixboro Rd	Went to investigate on my way home, noticed a light odor from Retention	0 mph/Calm

						Building over the Dixboro bridge. No odor observed at N Dixboro Rd. One staff member did not smell anything on his way in but another observed a slight odor when he arrived @ 8:50pm. Retention Building had "normal" smell inside the plant.	
10/22/2017	8:45am	[REDACTED]	734-276-5945	[REDACTED]	Sewer smells on Dixbor Rd near the plant	Noticed light Retention Building odor over Dixboro Rd bridge on way in to work at 8:40am. Noticed strong odor near Retention Building inside the plant. Other staff members smelled light odors over Dixboro bridge.	0 mph/Calm
10/28/2017	5:25pm	[REDACTED] Towsley Estates	None provided	[REDACTED]	Odor complaint	Plant doors and hatches closed at time of call. Investigated Towsley Estates, no odors observed or detected by meter.	12 mph SSW
11/3/2017	6:45pm	[REDACTED]	734-657-1420	[REDACTED]	Mr. Hupy said he could smell the plant from the fitness center next to St. Joe's Hospital	Went to fitness center. No odors observed or detected by meter at fitness center parking lot. Noticed odor in front of Retention Building inside the plant.	0 mph/Calm
11/7/2017	6:36pm	[REDACTED]	734-657-1420	[REDACTED]	Mr. Hupy said he could smell the plant from the fitness center next to Washtenaw Community College	Went to location, observed light door upon entering the fitness center. Drove around parking lot and smelled no odor. Grit doors were found open, all other closed. Grit doors closed upon return to the plant.	0 mph/Calm
11/25/2017	5:25pm	Caller from St. Joe's Hospital S. Tower	734-712-4090	[REDACTED]	Smelled strong odor	At 7:55am, noticed strong odor and found truck driver had not closed bay doors after he loaded. At 8:09 S. Tower called about odor, I explained what I had found and told them the odor should disappear shortly.	0 mph/Calm
11/28/2017	3:40pm	Towsley Estates [REDACTED]	734-668-1819	[REDACTED]	Horrible smell from plant that started a couple of days ago/smells like a dead animal.	Went to investigate. Upon arrival got quick whiff of a dead animal odor as we drove by a wooded area near the AA Township lift station. Observed the dead animal smell as we walked around the wooded lot. Between the wooded lot, township liftstation and plant we could smell anything when the wind direction was coming from the plant but could smell it when the wind swirled in the opposite direction.	8 mph SE with swirling gusts

ODOR COMPLAINT LOG 2018

DATE	TIME	CALL FROM	PHONE NUMBER	SUPERVISOR	COMPLAINT	RESPONSE/INVESTIGATION RESULTS	WIND
1/15/2018	8:25am	[REDACTED]	734-534-5830	[REDACTED]	Smelled sewage odor at her residence and at the intersections of "Plymouth Rd. and Geddes rd."	All doors and hatches were closed. Asked if they would be willing to meet to discuss the smell. Declined. JP and AW who came in did not notice the smell. Investigated intersection of Huron River Dr. and N. Dixboro and noticed no smell. Could not locate an intersection of Plymouth and Geddes. Believe she meant Huron and Dixboro. Manholes also had no odor. Gas Meter was normal except O2 was between 21.0-20.9 the whole time.	0 mph/Calm
2/27/2018	11:30am	[REDACTED]	734-395-3533	[REDACTED]	Smelled like sewage when walking in Towsley Estate Residence 1175 Towsley LN.	All Doors and hatches were closed, staff in process of taking E4 pass OOS, and cleaning of E4 primary and final tanks had just started. CA/KW took city van to address, walked property and could not smell any odor. Mr. Orringer also said he could no longer smell the odor. The property listed is at a 45 degree angle from pass E4 with wind blowing that direction.	SSW 16mph
2/27/2018	3:45pm	[REDACTED]	734-668-1819	[REDACTED]	"Smelled like a pig farm" reported by his wife to him, over the phone.	All doors and hatches were closed, plant staff taking E4 pass OOS, cleaning E4 primary and final tanks had started that day, E4 primary cleaning had just finished at time of call. Had JC and MK start filling E4 with PEW so open tank was not an issue over night and to help with odor.	SSW 16-20mph
4/29/2018	10:23pm	[REDACTED] at St. Joe's Hospital	734-712-4090	[REDACTED]	Mr. Jones stated some of the people at the hospital smelled a sewage smell.	All doors and hatches were closed, verified by WUS on rounds at time of call. TK/NF took van to hospital, walked wooded area and parking lot, smelled no odor. Gas detector did not detect anything and H2S and CO were zero. Also checked at plant entrance.	0 mph/Calm
5/1/2018	10:01pm	[REDACTED]	734-395-0212	[REDACTED]	Mr. Spencer stated a strong smell was around his house. Not sewage but "like something from a paper mill."	All doors and hatches were closed, TK and AT can verify. TK/AT took city van to address, drove full length of road and drove back (dead end). There was a smell as described around Mr. Spencer's house, AT could smell it as well, also described as papermill smell. Gas meter for H2S and O2 was zero. Smell centered around a crop of trees by the address and dissipated a few houses past Mr. Spencer's.	NE 10mph
6/25/2018	8:45pm	[REDACTED]	734-534-5830	[REDACTED]	Caller reported a sewer like odor around her residence	All doors and hatches were closed. AJ and WUS observed odor at front gate, no abnormal gas readings, odor was gone by bridge. Met resident, who lead them to where odor was strongest. Upon arrival there was no wastewater odor, just river. No abnormal gas readings. Walked property to same conclusion. Resident mentioned neighbor's septic field failed sometime in the last couple years and has not been replaced. Checked area near alleged septic field failure, including manhole, no odor or abnormal readings. Upon return, brief odor on Dixboro bridge.	0mph at plant, 5-10mph at residence
6/26/2018	7:08pm	[REDACTED]	734-534-5830	[REDACTED]	Caller reported a sewer smell from near her home	All plant doors and hatches were closed. Retention basin odor observed by front gate, no abnormal readings on gas detector. Odor was gone at the bridge before the plant gate. No odors present on arrival at caller's address. Checked manhole prior to dam, no odor or abnormal readings. Asked a couple bicyclers on the trail, they said that hadn't smelled any odors along the trail, including along the plant fence.	E 1mph

Odor complaint

6/25/18

Monday, 6/25/18 at 8:45pm – Call received by NJ on WUS cell

Caller reported a sewer like odor around her residence.

Della Dipietro - 121 N. Dixboro Rd.

(734) 534-5830

Wind – calm (0.0 mph from E according to pics)

Wind out of the east 5-10mph at the residence home.

69.5 F, Partly Cloudy

All plant doors and hatches were closed, at the time of the call. I asked **Ms. Dipietro** if he would be willing to meet me to discuss the smell, she accepted.

- AJ and I Left the plant @ 9:02pm. There was an odor observed by the front gate. No abnormal readings on the gas detector. Odor was gone at the bridge before the plant gate.
- Arrived at residence home @9:07pm. No odors present on arrival.
- Contacted **Ms. Dipietro** @9:09pm. She and Gary (her husband) came out to meet AJ and me. After a quick introduction, I asked where the smell was the strongest. She led us to a small covered walkway between the house and the garage. No odors noticed by myself, AJ or **Della** and Gary. No abnormal readings on the gas meter.
- After observing the covered walkway I asked if it would be ok if AJ and I walked the property. She encouraged it and asked to let them know when we were done. The walk through the property revealed no odor related to wastewater and no abnormal readings on the gas meter. There was an odor near the river but it smelled like river water opposed to wastewater.
- After the walkthrough I knocked on **Della's** door and told her our findings. I also mentioned we were going to check the manhole near the street and the dam area as well. At this point she mentioned that her neighbor's septic field failed sometime in the last couple years and has not been replaced. This could be part of the odor she was experiencing.
- Checked manhole prior to the dam, the area down by the dam and the area near the allegedly failed septic field. No odor or abnormal readings on the gas meter at any of those areas.
- On the way back to the plant there was a brief odor on the Dixboro Bridge. This dissipated quickly.
- AJ and I returned to the plant @9:30pm.

Question # 11

Supporting Information

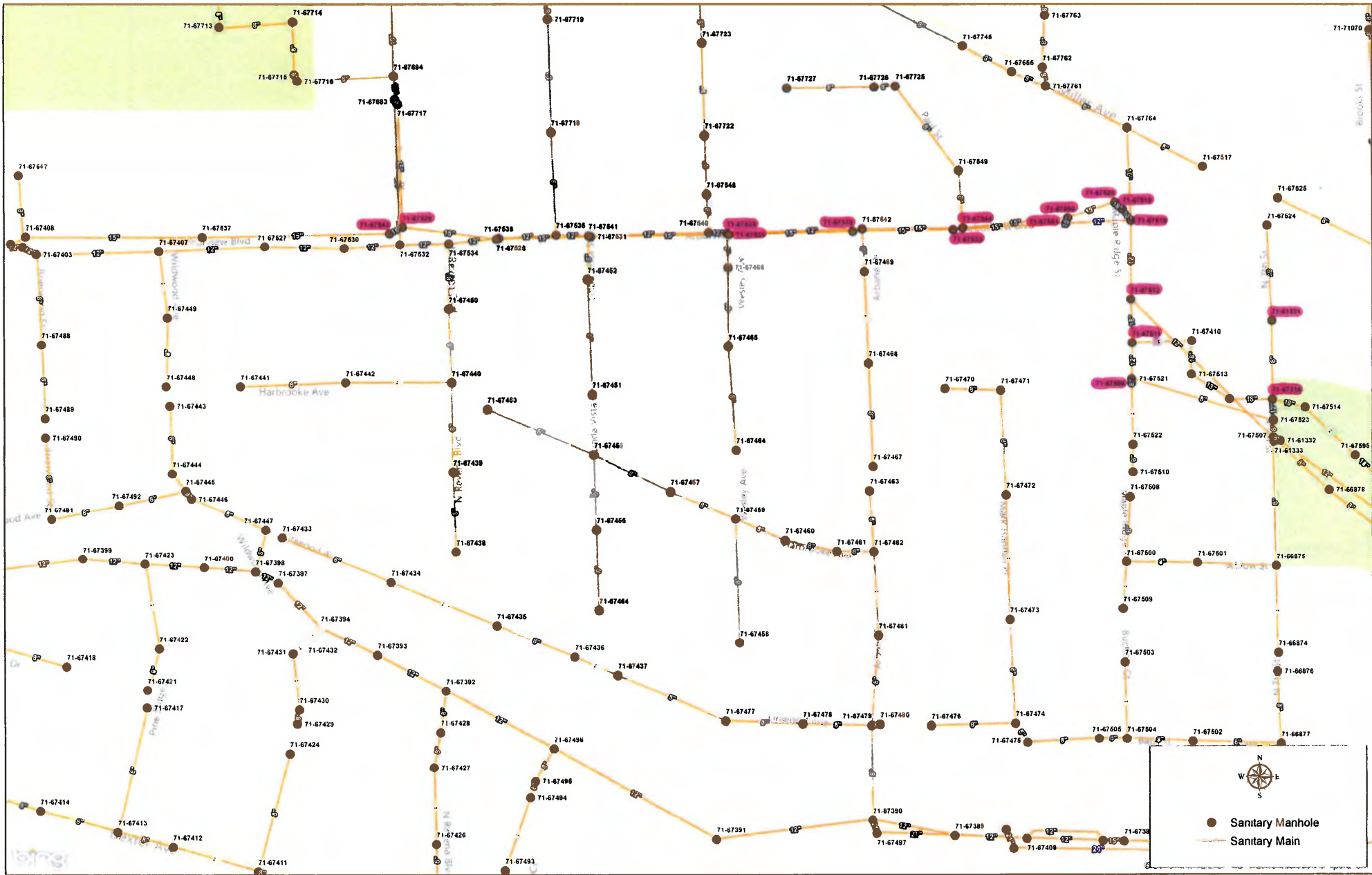

● Sanitary Manhole

 — Sanitary Main

Question # 13

Supporting Information

Background

Historically, Scio has utilized nitrate addition (Bioxide) to reduce the formation of H₂S within their Jackson Road pumping station's force main. This pump station is located at the northeast side of Jackson and Zeeb Roads. Scio ceased use of Bioxide in approximately 2008-2010. Scio discontinued use of the product because the treatment was reportedly found to be less effective than design expectations, and the product was found to create or exacerbate the existing presence of a floating layer of grease within the wet well which impacted the performance of mechanical equipment.

In 2014, a portion of the gravity sewer system located downstream of Scio's 3+ mile force main's discharge point (NE corner of Dexter Ave and N Maple Rd) was relined as part of an inflow and infiltration removal effort. The force main's discharge point, and the downstream gravity system, is located within Ann Arbor's city limits. Subsequent to the relining effort, increased complaints of odors were received by the City of Ann Arbor, from the neighborhoods located downstream of the relined sewers.

Based on field investigations and discussions with the City of Ann Arbor, Scio Township, and OHM Advisors (Township's engineer), the consensus was that increased odor complaints may be partly attributed to the sewer relining effort. Wastewaters within the Jackson Road pumping station's force main become anaerobic and generate H₂S odors. These odors are assumed to have been historically present, but are now being recognized by residents since the relined sewers no longer dissipate the H₂S via former leaks or other means.

To minimize the formation of H₂S, Scio Township and OHM Advisors completed a review of several H₂S control technologies for interim and future long-term use while considering the quality of the wastewater, current and future flow rates, O&M efforts, system reliability, and life cycle costs.

Short Term H₂S Reduction Efforts

Prior to demonstrating H₂S reduction efforts, baseline H₂S levels from Scio's force main outfall were collected. These levels ranged from 500 to 1000+ ppm during summer months. To reduce these values in the short-term, Scio brought the Bioxide system back online. Bioxide is currently dosed to maintain an average H₂S concentration of 20 ppm or less. Beyond liquid-phase treatment, Scio installed media-filled manhole inserts for odor-control at various gravity manhole inlets within the Arborview neighborhood. The inserts were installed in October 2015. The inserts are Persnickety brand, as manufactured by Syneco Systems Incorporated; the media is a patented polymeric amine. These systems are a reactive treatment technology, in that, they remove the sulfide (that comes to grade level) after its formed. The inserts and media remain installed and are maintained by Scio; the media is replenished when necessary. The inserts will remain until the long-term technology has been brought online.

Long Term H₂S Reduction Efforts

Several liquid-phase treatment technologies were considered for H₂S minimization. Ultimately, oxygen injection was selected as the long-term technology. The oxygen injection system will increase the dissolved oxygen level of the wastewater to control H₂S formation. Design of the oxygen injection system has been completed, and construction is in progress. System startup is anticipated to be complete in August 2018.

Per OHM, Scio Townships Engineer

Scio Twp is installing a superoxygenation system, as provided by ECO2 Technologies. This system is sized to handle the flows and loads experienced by the system's demands. The project intent is to provide a positive DO at the outfall's discharge. This will be accomplished by installing an oxygen source, speece cone (to cause the increase in DO), side stream pump (to overcome the head of the speece cone), and other associated equipment.

<http://www.eco2tech.com/>

The anticipated DO demand of the system (day and night time) is presented below.

Figure B: Dissolved Oxygen Required Over Forcemain Length at Average Flows per Set Point

