

CITY OF ANN ARBOR
INVITATION TO BID



Street Resurfacing Project - 2021

ITB No. 4667

Due Date: Tuesday, March 16, 2021, 10:00 a.m. (Local Time)

Engineering Unit
Public Services Area

Issued By:

City of Ann Arbor
Procurement Unit
301 E. Huron Street
Ann Arbor, MI 48104

TABLE OF CONTENTS

TABLE OF CONTENTS..... TC-1 to 2
NOTICE OF PRE-BID CONFERENCE..... NP-1
INSTRUCTIONS TO BIDDERS IB-1 to 6
INVITATION TO BID..... ITB-1 to 3
BID FORMS BF-8 to 16
CONTRACT C-1 to 4
BOND FORMS..... B-1 to 2
GENERAL CONDITIONS GC-1 to 18
STANDARD SPECIFICATIONS SS-1
DETAILED SPECIFICATIONS DS-1 to 149
APPENDIX..... APDX-1

ATTACHMENTS

- City of Ann Arbor Prevailing Wage Declaration Form*
- City of Ann Arbor Living Wage Forms*
- City of Ann Arbor Vendor Conflict of Interest Disclosure Form*
- City of Ann Arbor Non-Discrimination Ordinance Declaration Form and Notice*
- MDOT Certified Payroll Forms*

NOTICE OF PRE-BID CONFERENCE

A pre-bid conference for this project will not be held for this project. Please submit any questions that you may have regarding this project via e-mail as directed elsewhere in the contract documents.

Answers that change or substantially clarify the Invitation to Bid will be affirmed in an addendum.

INSTRUCTIONS TO BIDDERS

General

Work to be done under this Contract is generally described through the detailed specifications and must be completed fully in accordance with the contract documents. All work to be done under this Contract is located in or near the City of Ann Arbor.

Any Bid which does not conform fully to these instructions may be rejected.

Preparation of Bids

Bids should be prepared providing a straight-forward, concise description of the Bidder's ability to meet the requirements of the ITB. Bids shall be written in ink or typewritten. No erasures are permitted. Mistakes may be crossed out and corrected and must be initialed and dated in ink by the person signing the Bid.

Bids must be submitted on the "Bid Forms" provided with each blank properly filled in. If forms are not fully completed it may disqualify the bid. No alternative bid will be considered unless alternative bids are specifically requested. If alternatives are requested, any deviation from the specification must be fully described, in detail on the "Alternate" section of Bid form.

Each person signing the Bid certifies that he/she is the person in the Bidder's firm/organization responsible for the decision as to the fees being offered in the Bid and has not and will not participated in any action contrary to the terms of this provision.

Questions or Clarifications / Designated City Contacts

All questions regarding this ITB shall be submitted via email. Emailed questions and inquires will be accepted from any and all prospective Bidders in accordance with the terms and conditions of the ITB.

All questions shall be due on or before **Friday, March 5, 2021, at 5:00 p.m. (local time)** and should be addressed as follows:

Specification/Scope of Work questions emailed to **ddykman@a2gov.org**
Bid Process and Compliance questions emailed to **cspencer@a2gov.org**

Any error, omissions or discrepancies in the specification discovered by a prospective contractor and/or service provider shall be brought to the attention **David Dykman, Project Manager** at **ddykman@a2gov.org** after discovery as possible. Further, the contractor and/or service provide shall not be allowed to take advantage of errors, omissions or discrepancies in the specifications.

Addenda

If it becomes necessary to revise any part of the ITB, notice of the Addendum will be posted to Michigan Inter-governmental Trade Network (MITN) www.mitn.info and/or City of Ann Arbor web site www.A2gov.org for all parties to download.

Each Bidder must in its Bid, to avoid any miscommunications, acknowledge all addenda which it has received, but the failure of a Bidder to receive, or acknowledge receipt of; any addenda shall

not relieve the Bidder of the responsibility for complying with the terms thereof. The City will not be bound by oral responses to inquiries or written responses other than written addenda.

Bid Submission

All Bids are due and must be delivered to the City of Ann Arbor Procurement Unit on or before **Tuesday, March 16, 2021, at 10:00 a.m. (local time)**. Bids submitted late or via oral, telephonic, telegraphic, electronic mail or facsimile **will not** be considered or accepted.

Each Bidder must submit one (1) original Bid and **one (1)** Bid copies in a sealed envelope clearly marked: **ITB No. 4667, Street Resurfacing Project - 2021**.

Bids must be addressed and delivered to:

City of Ann Arbor
Procurement Unit,
c/o Customer Services, 1st Floor
301 East Huron Street
Ann Arbor, MI 48104

All Bids received on or before the Due Date will be publicly opened and recorded immediately. No immediate decisions are rendered.

The following forms provided within this ITB Document must be included in submitted bids.

- **City of Ann Arbor Prevailing Wage Declaration of Compliance**
- **City of Ann Arbor Living Wage Ordinance Declaration of Compliance**
- **Vendor Conflict of Interest Disclosure Form**
- **City of Ann Arbor Non-Discrimination Ordinance Declaration of Compliance**

Bids that fail to provide these forms listed above upon bid opening will be rejected as non-responsive and will not be considered for award.

Hand delivered bids may be dropped off in the Purchasing drop box located in the Ann Street (north) vestibule/entrance of City Hall which is accessible to the public at all hours. The City will not be liable to any Bidder for any unforeseen circumstances, delivery or postal delays. Postmarking to the Due Date will not substitute for receipt of the Bid. Each Bidder is responsible for submission of their Bid.

Additional time for submission of bids past the stated due date and time will not be granted to a single Bidder; however, additional time may be granted to all Bidders when the City determines in its sole discretion that circumstances warrant it.

Award

The City intends to award a Contract(s) to the lowest responsible Bidder(s). On multi-divisional contracts, separate divisions may be awarded to separate Bidders. The City may also utilize alternatives offered in the Bid Forms, if any, to determine the lowest responsible Bidder on each division, and award multiple divisions to a single Bidder, so that the lowest total cost is achieved for the City. For unit price bids, the Contract will be awarded based upon the unit prices and the lump sum prices stated by the bidder for the work items specified in the bid documents, with consideration given to any alternates selected by the City. If the City determines that the unit price for any item is materially different for the work item bid than either other bidders or the general market, the City, in its sole discretion, in addition to any other right it may have, may reject the bid as not responsible or non-conforming.

The acceptability of major subcontractors will be considered in determining if a Bidder is responsible. In comparing Bids, the City will give consideration to alternate Bids for items listed in the bid forms. All key staff and subcontractors are subject to the approval by the City.

Official Documents

The City of Ann Arbor officially distributes bid documents from the Procurement Unit or through the Michigan Intergovernmental Trade Network (MITN). Copies of the bid documents obtained from any other source are not Official copies. Addenda and other bid information will only be posted to these official distribution sites. If you obtained City of Ann Arbor Bid documents from other sources, it is recommended that you register on www.MITN.info and obtain an official Bid. Bidders do not need to be shown on the plan holders list provided by MITN to be considered an official plan holder.

Bid Security

Each bid must be accompanied by a certified check, or Bid Bond by a surety licensed and authorized to do business within the State of Michigan, in the amount of 5% of the total of the bid price.

Withdrawal of Bids

After the time of opening, no Bid may be withdrawn for the period of sixty (60) days.

Contract Time

Time is of the essence in the performance of the work under this Contract. The available time for work under this Contract is indicated on page C-2, Article III of the Contract. If these time requirements cannot be met, the Bidder must stipulate on Bid Form Section 3 - Time Alternate its schedule for performance of the work. Consideration will be given to time in evaluating bids.

Liquidated Damages

A liquidated damages clause, as given on page C-2, Article III of the Contract, provides that the Contractor shall pay the City as liquidated damages, and not as a penalty, a sum certain per day for each and every day that the Contractor may be in default of completion of the specified work, within the time(s) stated in the Contract, or written extensions.

Liquidated damages clauses, as given in the General Conditions, provide further that the City shall be entitled to impose and recover liquidated damages for breach of the obligations under Chapter 112 of the City Code.

The liquidated damages are for the non-quantifiable aspects of any of the previously identified events and do not cover actual damages that can be shown or quantified nor are they intended to preclude recovery of actual damages in addition to the recovery of liquidated damages.

Human Rights Information

All contractors proposing to do business with the City shall satisfy the contract compliance administrative policy adopted by the City Administrator in accordance with the Section 9:158 of the Ann Arbor City Code. Breach of the obligation not to discriminate as outlined in Section 5, beginning at page GC-2 shall be a material breach of the contract. Contractors are required to post a copy of Ann Arbor's Non-Discrimination Ordinance attached at all work locations where its employees provide services under a contract with the City.

Wage Requirements

Section 4, beginning at page GC-1, outlines the requirements for payment of prevailing wages and for payment of a "living wage" to employees providing service to the City under this contract. The successful bidder and its subcontractors must comply with all applicable requirements and provide proof of compliance.

Pursuant to Resolution R-16-469 all public improvement contractors are subject to prevailing wage and will be required to provide to the City payroll records sufficient to demonstrate compliance with the prevailing wage requirements. Use of the Prevailing Wage Form provided in the Appendix section or a City-approved equivalent will be required along with wage rate interviews.

For laborers whose wage level are subject to federal, state and/or local prevailing wage law the appropriate Davis-Bacon wage rate classification is identified based upon the work including within this contract. **The wage determination(s) current on the date 10 days before bids are due shall apply to this contract.** The U.S. Department of Labor (DOL) has provided explanations to assist with classification in the following resource link: beta.SAM.gov.

For the purposes of this ITB the Construction Type of Highway will apply.

Conflict Of Interest Disclosure

The City of Ann Arbor Purchasing Policy requires that prospective Vendors complete a Conflict of Interest Disclosure form. A contract may not be awarded to the selected Vendor unless and until the Procurement Unit and the City Administrator have reviewed the Disclosure form and determined that no conflict exists under applicable federal, state, or local law or administrative regulation. Not every relationship or situation disclosed on the Disclosure Form may be a disqualifying conflict. Depending on applicable law and regulations, some contracts may awarded on the recommendation of the City Administrator after full disclosure, where such action is allowed by law, if demonstrated competitive pricing exists and/or it is determined the award is in the best interest of the City. A copy of the Vendor Conflict of Interest Disclosure Form is attached.

Major Subcontractors

The Bidder shall identify on Bid Form Section 4 each major subcontractor it expects to engage for this Contract if the work to be subcontracted is 15% or more of the bid sum or over \$50,000, whichever is less. The Bidder also shall identify the work to be subcontracted to each major subcontractor. The Bidder shall not change or replace a subcontractor without approval by the City.

Debarment

Submission of a Bid in response to this ITB is certification that the Bidder is not currently debarred, suspended, proposed for debarment, and declared ineligible or voluntarily excluded from participation in this transaction by any State or Federal departments or agency. Submission is also agreement that the City will be notified of any changes in this status.

Disclosures

After bids are opened, all information in a submitter's bid is subjected to disclosure under the provisions of Michigan Public Act No. 442 of 1976, as amended (MCL 15.231 et seq.) known as the "Freedom of Information Act." The Freedom of Information Act also provides for the complete disclosure of contracts and attachments thereto except where specifically exempted.

Bid Protest

All Bid protests must be in writing and filed with the Purchasing Agent within five (5) business days of the award action. The bidder must clearly state the reasons for the protest. If a bidder contacts a City Service Area/Unit and indicates a desire to protest an award, the Service Area/Unit shall refer the bidder to the Purchasing Agent. The Purchasing Agent will provide the bidder with the appropriate instructions for filing the protest. The protest shall be reviewed by the City Administrator or designee whose decision shall be final.

Any inquiries or requests regarding this procurement should be only submitted in writing to the Designated City Contacts provided herein. Attempts by any prospective bidder to initiate contact with anyone other than the Designated City Contacts provided herein that the bidder believes can influence the procurement decision, e.g., Elected Officials, City Administrator, Selection Committee Members, Appointed Committee Members, etc., may lead to immediate elimination from further consideration.

Cost Liability

The City of Ann Arbor assumes no responsibility or liability for costs incurred by the Bidder prior to the execution of a contract with the City. By submitting a bid, a bidder agrees to bear all costs incurred or related to the preparation, submission and selection process for the bid.

Reservation of Rights

The City of Ann Arbor reserves the right to accept any bid or alternative bid proposed in whole or in part, to reject any or all bids or alternatives bids in whole or in part and to waive irregularity and/or informalities in any bid and to make the award in any manner deemed in the best interest of the City.

Idlefree Ordinance

The City of Ann Arbor adopted an idling reduction Ordinance that goes into effect July 1, 2017. The full text of the ordinance (including exemptions) can be found at: www.a2gov.org/idlefree.

Under the ordinance, No Operator of a Commercial Vehicle shall cause or permit the Commercial Vehicle to Idle:

- (a) For any period of time while the Commercial Vehicle is unoccupied; or
- (b) For more than 5 minutes in any 60-minute period while the Commercial Vehicle is occupied.

In addition, generators and other internal combustion engines are covered

(1) Excluding Motor Vehicle engines, no internal combustion engine shall be operated except when it is providing power or electrical energy to equipment or a tool that is actively in use.

Environmental Commitment

The City of Ann Arbor recognizes its responsibility to minimize negative impacts on human health and the environment while supporting a vibrant community and economy. The City further recognizes that the products and services the City buys have inherent environmental and economic impacts and that the City should make procurement decisions that embody, promote, and encourage the City's commitment to the environment.

The City encourages potential vendors to bring forward emerging and progressive products and services that are best suited to the City's environmental principles.

INVITATION TO BID

City of Ann Arbor
Guy C. Larcom Municipal Building
Ann Arbor, Michigan 48107

Ladies and Gentlemen:

The undersigned, as Bidder, declares that this Bid is made in good faith, without fraud or collusion with any person or persons bidding on the same Contract; that this Bidder has carefully read and examined the bid documents, including City Nondiscrimination requirements and Declaration of Compliance Form, Living Wage requirements and Declaration of Compliance Form, Prevailing Wage requirements and Declaration of Compliance Form, Vendor Conflict of Interest Form, Notice of Pre-Bid Conference, Instructions to Bidders, Bid, Bid Forms, Contract, Bond Forms, General Conditions, Standard Specifications, Detailed Specifications, all Addenda, and the Plans (if applicable) and understands them. The Bidder declares that it conducted a full investigation at the site and of the work proposed and is fully informed as to the nature of the work and the conditions relating to the work's performance. The Bidder also declares that it has extensive experience in successfully completing projects similar to this one.

The Bidder acknowledges that it has not received or relied upon any representations or warrants of any nature whatsoever from the City of Ann Arbor, its agents or employees, and that this Bid is based solely upon the Bidder's own independent business judgment.

The undersigned proposes to perform all work shown on the plans or described in the bid documents, including any addenda issued, and to furnish all necessary machinery, tools, apparatus, and other means of construction to do all the work, furnish all the materials, and complete the work in strict accordance with all terms of the Contract of which this Bid is one part.

In accordance with these bid documents, and Addenda numbered _____, the undersigned, as Bidder, proposes to perform at the sites in and/or around Ann Arbor, Michigan, all the work included herein for the amounts set forth in the Bid Forms.

The Bidder declares that it has become fully familiar with the liquidated damage clauses for completion times and for compliance with City Code Chapter 112, understands and agrees that the liquidated damages are for the non-quantifiable aspects of non-compliance and do not cover actual damages that may be shown and agrees that if awarded the Contract, all liquidated damage clauses form part of the Contract.

The Bidder declares that it has become fully familiar with the provisions of Chapter 14, Section 1:320 (Prevailing wages) and Chapter 23 (Living Wage) of the Code of the City of Ann Arbor and that it understands and agrees to comply, to the extent applicable to employees providing services to the City under this Contract, with the wage and reporting requirements stated in the City Code provisions cited. Bidder certifies that the statements contained in the City Prevailing Wage and Living Wage Declaration of Compliance Forms are true and correct. Bidder further agrees that the cited provisions of Chapter 14 and Chapter 23 form a part of this Contract.

The Bidder declares that it has become familiar with the City Conflict of Interest Disclosure Form and certifies that the statement contained therein is true and correct.

The Bidder encloses a certified check or Bid Bond in the amount of 5% of the total of the Bid

Price. The Bidder agrees both to contract for the work and to furnish the necessary Bonds and insurance documentation within 10 days after being notified of the acceptance of the Bid.

If this Bid is accepted by the City and the Bidder fails to contract and furnish the required Bonds and insurance documentation within 10 days after being notified of the acceptance of this Bid, then the Bidder shall be considered to have abandoned the Contract and the certified check or Bid Bond accompanying this Bid shall become due and payable to the City.

If the Bidder enters into the Contract in accordance with this Bid, or if this Bid is rejected, then the accompanying check or Bid Bond shall be returned to the Bidder.

In submitting this Bid, it is understood that the right is reserved by the City to accept any Bid, to reject any or all Bids, to waive irregularities and/or informalities in any Bid, and to make the award in any manner the City believes to be in its best interest.

SIGNED THIS _____ DAY OF _____, 202_.

Bidder's Name

Authorized Signature of Bidder

Official Address

(Print Name of Signer Above)

Telephone Number

Email Address for Award Notice

LEGAL STATUS OF BIDDER

(The Bidder shall fill out the appropriate form and strike out the other three.)

Bidder declares that it is:

* A corporation organized and doing business under the laws of the State of _____, for whom _____, bearing the office title of _____, whose signature is affixed to this Bid, is authorized to execute contracts.

NOTE: If not incorporated in Michigan, please attach the corporation's Certificate of Authority

• A limited liability company doing business under the laws of the State of _____, whom _____ bearing the title of _____ whose signature is affixed to this proposal, is authorized to execute contract on behalf of the LLC.

* A partnership, organized under the laws of the state of _____ and filed in the county of _____, whose members are (list all members and the street and mailing address of each) (attach separate sheet if necessary):

* An individual, whose signature with address, is affixed to this Bid: _____ (initial here)

Authorized Official

_____ **Date** _____, 202_

(Print) Name _____ Title _____

Company: _____

Address: _____

Contact Phone () _____ Fax () _____

Email _____

BID FORM

Section 1 - Schedule of Prices

City of Ann Arbor Street Resurfacing Project - 2021
File No. 2021-004
Bid No. 4667

<u>Line No.</u>	<u>Item No.</u>	<u>Item Description</u>	<u>Unit</u>	<u>Estimated Quantity</u>	<u>Unit Price</u>	<u>Total Price</u>
0	1047051	_Certified Payroll Compliance and Reporting	LS	1.00	\$ _____	\$ _____
0	1047051	_General Conditions, Max \$275,000.00	LS	1.00	\$ _____	\$ _____
0	1047051	_Project Supervision, Max \$50,000.00	LS	1.00	\$ _____	\$ _____
0	2030011	Dr Structure, Rem	Ea	125.00	\$ _____	\$ _____
0	2030015	Sewer, Rem, Less than 24 inch	Ft	1,250.00	\$ _____	\$ _____
0	2040005	Pavt, Rem	Syd	43.00	\$ _____	\$ _____
0	2047001	_Curb, Gutter, and Curb and Gutter, Any Type, Rem	Ft	25,326.00	\$ _____	\$ _____
0	2047001	_Exploratory Excavation, Vertical	Ft	5.00	\$ _____	\$ _____
0	2047011	_Sidewalk, Sidewalk Ramp, and Driveway Approach, Any Thickness, Rem	Syd	5,532.00	\$ _____	\$ _____
0	2050023	Granular Material, CI II	Cyd	50.00	\$ _____	\$ _____
0	2057011	_Grading, Driveway Approach	Syd	3,573.00	\$ _____	\$ _____
0	2057011	_Grading, Sidewalk	Syd	910.00	\$ _____	\$ _____
0	2057011	_Grading, Sidewalk Ramp	Syd	514.00	\$ _____	\$ _____
0	2057011	_Machine Grading, Special	Syd	87,813.00	\$ _____	\$ _____
0	2057021	_Undercutting, Type IIA	Cyd	2,831.00	\$ _____	\$ _____
0	2057021	_Undercutting, Type IIB	Cyd	50.00	\$ _____	\$ _____
0	2057021	_Undercutting, Type IIC	Cyd	150.00	\$ _____	\$ _____
0	2080020	Erosion Control, Inlet Protection, Fabric Drop	Ea	311.00	\$ _____	\$ _____
TOTAL THIS PAGE						\$ _____

BID FORM

Section 1 - Schedule of Prices

<u>Line No.</u>	<u>Item No.</u>	<u>Item Description</u>	<u>Unit</u>	<u>Estimated Quantity</u>	<u>Unit Price</u>	<u>Total Price</u>
0	2080036	Erosion Control, Silt Fence	Ft	794.00	\$ _____	\$ _____
0	2090001	Project Cleanup	LS	1.00	\$ _____	\$ _____
0	3010002	Subbase, CIP	Cyd	50.00	\$ _____	\$ _____
0	3027011	_Aggregate Base, 6 inch, Modified	Syd	5,628.00	\$ _____	\$ _____
0	3027011	_Aggregate Base, 8 inch, Modified	Syd	3,209.00	\$ _____	\$ _____
0	3027031	_Aggregate Base, Modified	Ton	250.00	\$ _____	\$ _____
0	3050010	Material, Surplus and Unsuitable, Rem, LM	Cyd	15.00	\$ _____	\$ _____
0	3050015	Salv Crushed Material, LM	Cyd	25.00	\$ _____	\$ _____
0	3057011	_Shared use Path, HMA Base Crushing and Shaping	Syd	2,630.00	\$ _____	\$ _____
0	3060020	Maintenance Gravel	Ton	150.00	\$ _____	\$ _____
0	3077001	_Trenching, Modified	Ft	7,220.00	\$ _____	\$ _____
0	3080010	Geotextile, Stabilization	Syd	100.00	\$ _____	\$ _____
0	3087011	_Structural Geogrid (Base)	Syd	250.00	\$ _____	\$ _____
0	4020987	Sewer, CI IV, 12 inch, Tr Det B	Ft	1,150.00	\$ _____	\$ _____
0	4021260	Trench Undercut and Backfill	Cyd	345.00	\$ _____	\$ _____
0	4030200	Dr Structure, 24 inch dia	Ea	115.00	\$ _____	\$ _____
0	4030210	Dr Structure, 48 inch dia	Ea	1.00	\$ _____	\$ _____
0	4030280	Dr Structure, Adj, Add Depth	Ft	3.00	\$ _____	\$ _____
0	4030306	Dr Structure, Tap, 6 inch	Ea	5.00	\$ _____	\$ _____
					TOTAL THIS PAGE	\$ _____

BID FORM

Section 1 - Schedule of Prices

<u>Line No.</u>	<u>Item No.</u>	<u>Item Description</u>	<u>Unit</u>	<u>Estimated Quantity</u>	<u>Unit Price</u>	<u>Total Price</u>
0	4030312	Dr Structure, Tap, 12 inch	Ea	2.00	\$ _____	\$ _____
0	4037050	_Dr Structure Cover, Special	Ea	2.00	\$ _____	\$ _____
0	4037050	_Dr Structure Cover, Type B, Modified	Ea	147.00	\$ _____	\$ _____
0	4037050	_Dr Structure Cover, Type C, Modified	Ea	2.00	\$ _____	\$ _____
0	4037050	_Dr Structure Cover, Type D, Modified	Ea	2.00	\$ _____	\$ _____
0	4037050	_Dr Structure Cover, Type D, Modified (ADA Cover/Grate)	Ea	1.00	\$ _____	\$ _____
0	4037050	_Dr Structure Cover, Type K, Modified	Ea	138.00	\$ _____	\$ _____
0	4037050	_Dr Structure, Adj, Case 1, Modified	Ea	255.00	\$ _____	\$ _____
0	4037050	_Dr Structure, Adj, Case 2, Modified	Ea	3.00	\$ _____	\$ _____
0	4037050	_Dr Structure, Cleaning, Modified	Ea	28.00	\$ _____	\$ _____
0	4037050	_Dr Structure, Double Inlet	Ea	2.00	\$ _____	\$ _____
0	4037050	_Dr Structure, Point	Ea	15.00	\$ _____	\$ _____
0	4037050	_Dr Structure, Temp Lowering, Modified	Ea	226.00	\$ _____	\$ _____
0	4037050	_Structure, Reconstruct	Ea	2.00	\$ _____	\$ _____
0	4047001	_Underdrain, Subgrade, 6 inch, Special	Ft	1,170.00	\$ _____	\$ _____
0	4047001	_Yard Drain, Outlet Ending, Plastic Pipe	Ft	15.00	\$ _____	\$ _____
0	4047050	_Yard Drain, Outlet Ending, Pop-up Apparatus	Ea	9.00	\$ _____	\$ _____
0	5010001	Pavt, Cleaning	LS	1.00	\$ _____	\$ _____
0	5010002	Cold Milling HMA Surface	Syd	101,086.00	\$ _____	\$ _____
TOTAL THIS PAGE						\$ _____

BID FORM

Section 1 - Schedule of Prices

<u>Line No.</u>	<u>Item No.</u>	<u>Item Description</u>	<u>Unit</u>	<u>Estimated Quantity</u>	<u>Unit Price</u>	<u>Total Price</u>
0	5010005	HMA Surface, Rem	Syd	3,677.00	\$ _____	\$ _____
0	5010025	Hand Patching	Ton	357.00	\$ _____	\$ _____
0	5010061	HMA Approach	Ton	484.00	\$ _____	\$ _____
0	5010703	HMA, LVSP	Ton	19,764.00	\$ _____	\$ _____
0	5017011	_Cold Milling for Concrete Curb and Gutter Reveal	Syd	2,856.00	\$ _____	\$ _____
0	5017011	_Cold Milling HMA Surface, Modified	Syd	205.00	\$ _____	\$ _____
0	5017011	_Raised Crosswalk, HMA	Syd	61.00	\$ _____	\$ _____
0	5017011	_Raised Intersection, HMA	Syd	1,737.00	\$ _____	\$ _____
0	5017011	_Speed Hump, HMA	Syd	185.00	\$ _____	\$ _____
0	5017011	_Speed Table, HMA	Syd	35.00	\$ _____	\$ _____
0	5017031	_Hand Patching, Modified	Ton	100.00	\$ _____	\$ _____
0	5017031	_HMA, Wedging, 36A	Ton	33.00	\$ _____	\$ _____
0	6027011	_Raised Crosswalk, Conc	Syd	61.00	\$ _____	\$ _____
0	6027011	_Raised Intersection, Conc	Syd	1,737.00	\$ _____	\$ _____
0	6027011	_Speed Hump, Conc	Syd	185.00	\$ _____	\$ _____
0	6027011	_Speed Table, Conc	Syd	35.00	\$ _____	\$ _____
0	6027021	_Flowable Fill	Cyd	424.00	\$ _____	\$ _____
0	6030005	Cement	Ton	74.00	\$ _____	\$ _____
0	8017011	_Driveway, Nonreinf Conc, 6 inch, Modified	Syd	3,349.00	\$ _____	\$ _____
TOTAL THIS PAGE						\$ _____

BID FORM

Section 1 - Schedule of Prices

<u>Line No.</u>	<u>Item No.</u>	<u>Item Description</u>	<u>Unit</u>	<u>Estimated Quantity</u>	<u>Unit Price</u>	<u>Total Price</u>
0	8017011	_Driveway, Nonreinf Conc, 8 inch, Modified	Syd	181.00	\$ _____	\$ _____
0	8027001	_Curb and Gutter, Conc, Barrier	Ft	8,842.00	\$ _____	\$ _____
0	8027001	_Curb and Gutter, Conc, Barrier or Mountable, Slip Form	Ft	5,767.00	\$ _____	\$ _____
0	8027001	_Curb and Gutter, Conc, Mountable	Ft	754.00	\$ _____	\$ _____
0	8027001	_Driveway Opening, Conc, Det M, Modified	Ft	8,687.00	\$ _____	\$ _____
0	8030030	Curb Ramp Opening, Conc	Ft	591.00	\$ _____	\$ _____
0	8037001	_Detectable Warning Surface, Modified	Ft	455.00	\$ _____	\$ _____
0	8037010	_Sidewalk Ramp, Conc, 6 inch, Modified	Sft	4,630.00	\$ _____	\$ _____
0	8037010	_Sidewalk Ramp, Conc, 8 inch, Modified	Sft	50.00	\$ _____	\$ _____
0	8037010	_Sidewalk Retaining Wall, Integral, 6 inch to 18 inch Height	Sft	350.00	\$ _____	\$ _____
0	8037010	_Sidewalk Retaining Wall, Integral, 18 inch to 30 inch Height	Sft	150.00	\$ _____	\$ _____
0	8037010	_Sidewalk, Conc or Clay Brick Pavers, Rem and Reinstall	Sft	41.00	\$ _____	\$ _____
0	8037010	_Sidewalk, Conc, 4 inch, Modified	Sft	6,671.00	\$ _____	\$ _____
0	8037010	_Sidewalk, Conc, 6 inch, Modified	Sft	1,217.00	\$ _____	\$ _____
0	8037010	_Sidewalk, Conc, 8 inch, Modified	Sft	310.00	\$ _____	\$ _____
0	8060040	Shared use Path, HMA	Ton	1,138.00	\$ _____	\$ _____
0	8067011	_Shared use Path, Grading, Modified	Syd	26.00	\$ _____	\$ _____
0	8067031	_Shared use Path, HMA, Wedging	Ton	50.00	\$ _____	\$ _____
0	8087001	_Fence, Protective, Modified	Ft	1,500.00	\$ _____	\$ _____
TOTAL THIS PAGE						\$ _____

BID FORM

Section 1 - Schedule of Prices

<u>Line No.</u>	<u>Item No.</u>	<u>Item Description</u>	<u>Unit</u>	<u>Estimated Quantity</u>	<u>Unit Price</u>	<u>Total Price</u>
0	8110092	Pavt Mrkg, Polyurea, 4 inch, Yellow	Ft	1,186.00	\$ _____	\$ _____
0	8110197	Pavt Mrkg, Thermopl, 6 inch, Crosswalk	Ft	3,219.00	\$ _____	\$ _____
0	8110214	Pavt Mrkg, Thermopl, 12 inch, Crosswalk	Ft	728.00	\$ _____	\$ _____
0	8110218	Pavt Mrkg, Thermopl, 24 inch, Stop Bar	Ft	597.00	\$ _____	\$ _____
0	8110293	Pavt Mrkg, Waterborne, for Rest Areas, Parks, & Lots, 4 inch, Blue	Ft	140.00	\$ _____	\$ _____
0	8110294	Pavt Mrkg, Waterborne, for Rest Areas, Parks, & Lots, 4 inch, White	Ft	1,764.00	\$ _____	\$ _____
0	8117050	_Pavt Mrkg, Ovly Cold Plastic, Speed Hump Chevron, White	Ea	42.00	\$ _____	\$ _____
0	8117050	_Pavt Mrkg, Polyurea, Speed Hump Chevron, White	Ea	42.00	\$ _____	\$ _____
0	8117050	_Pavt Mrkg, Thermopl, School	Ea	4.00	\$ _____	\$ _____
0	8117050	_Pavt Mrkg, Thermopl, Speed Hump Chevron, White	Ea	66.00	\$ _____	\$ _____
0	8120012	Barricade, Type III, High Intensity, Double Sided, Lighted, Furn	Ea	98.00	\$ _____	\$ _____
0	8120013	Barricade, Type III, High Intensity, Double Sided, Lighted, Oper	Ea	98.00	\$ _____	\$ _____
0	8120035	Channelizing Device, 42 inch, Fluorescent, Furn	Ea	261.00	\$ _____	\$ _____
0	8120036	Channelizing Device, 42 inch, Fluorescent, Oper	Ea	261.00	\$ _____	\$ _____
0	8120140	Lighted Arrow, Type C, Furn	Ea	3.00	\$ _____	\$ _____
0	8120141	Lighted Arrow, Type C, Oper	Ea	11.00	\$ _____	\$ _____
0	8120252	Plastic Drum, Fluorescent, Furn	Ea	1,071.00	\$ _____	\$ _____
0	8120253	Plastic Drum, Fluorescent, Oper	Ea	1,071.00	\$ _____	\$ _____
0	8120310	Sign Cover	Ea	2.00	\$ _____	\$ _____
TOTAL THIS PAGE						\$ _____

BID FORM

Section 1 - Schedule of Prices

<u>Line No.</u>	<u>Item No.</u>	<u>Item Description</u>	<u>Unit</u>	<u>Estimated Quantity</u>	<u>Unit Price</u>	<u>Total Price</u>
0	8120330	Sign, Portable, Changeable Message, Furn	Ea	8.00	\$ _____	\$ _____
0	8120331	Sign, Portable, Changeable Message, Oper	Ea	10.00	\$ _____	\$ _____
0	8120350	Sign, Type B, Temp, Prismatic, Furn	Sft	3,078.00	\$ _____	\$ _____
0	8120351	Sign, Type B, Temp, Prismatic, Oper	Sft	3,078.00	\$ _____	\$ _____
0	8120352	Sign, Type B, Temp, Prismatic, Special, Furn	Sft	432.00	\$ _____	\$ _____
0	8120353	Sign, Type B, Temp, Prismatic, Special, Oper	Sft	432.00	\$ _____	\$ _____
0	8120370	Traf Regulator Control	LS	1.00	\$ _____	\$ _____
0	8127050	_Pedestrian Type II Barricade, Temp	Ea	77.00	\$ _____	\$ _____
0	8127050	_Pedestrian Type II Channelizer, Temp	Ea	8.00	\$ _____	\$ _____
0	8127050	_Temporary No Parking Sign	Ea	896.00	\$ _____	\$ _____
0	8127051	_Minor Traffic Control, Max \$100,000.00	LS	1.00	\$ _____	\$ _____
0	8157060	_Irrigation System, Protection and Maintenance	Dlr	2,500.00	\$ _____	\$ _____
0	8167011	_Slope Restoration	Syd	7,603.00	\$ _____	\$ _____
0	8190159	Conduit, Schedule 80 PVC, 3 inch	Ft	50.00	\$ _____	\$ _____
0	8190244	Hh, Adj	Ea	2.00	\$ _____	\$ _____
0	8197050	_Handhole Assembly, 12 Inch x 18 Inch	Ea	1.00	\$ _____	\$ _____
0	8197050	_Handhole Assembly, 17 Inch x 30 Inch	Ea	1.00	\$ _____	\$ _____
0	8197050	_Handhole Assembly, 24 inch x 36 inch	Ea	1.00	\$ _____	\$ _____
0	8217050	_Monument Box, Adj	Ea	5.00	\$ _____	\$ _____
TOTAL THIS PAGE						\$ _____

BID FORM

Section 1 - Schedule of Prices

<u>Line No.</u>	<u>Item No.</u>	<u>Item Description</u>	<u>Unit</u>	<u>Estimated Quantity</u>	<u>Unit Price</u>	<u>Total Price</u>
0	8230421	Water Shutoff, Adj, Case 1	Ea	5.00	\$ _____	\$ _____
0	8230431	Gate Box, Adj, Case 1	Ea	36.00	\$ _____	\$ _____
0	8230432	Gate Box, Adj, Case 2	Ea	5.00	\$ _____	\$ _____
0	8507050	_HMA Surface, Around Structure Cover, Rem	Ea	100.00	\$ _____	\$ _____
TOTAL THIS PAGE						\$ _____
TOTAL FROM PAGE BF-1						\$ _____
TOTAL FROM PAGE BF-2						\$ _____
TOTAL FROM PAGE BF-3						\$ _____
TOTAL FROM PAGE BF-4						\$ _____
TOTAL FROM PAGE BF-5						\$ _____
TOTAL FROM PAGE BF-6						\$ _____
TOTAL FROM PAGE BF-7						\$ _____
TOTAL BASE BID						\$ _____

BID FORM

Section 2 – Material, Equipment and Environmental Alternates

The Base Bid proposal price shall include materials and equipment selected from the designated items and manufacturers listed in the bidding documents. This is done to establish uniformity in bidding and to establish standards of quality for the items named.

If the Contractor wishes to quote alternate items for consideration by the City, it may do so under this Section. A complete description of the item and the proposed price differential must be provided. Unless approved at the time of award, substitutions where items are specifically named will be considered only as a negotiated change in Contract Sum.

If an environmental alternative is bid the City strongly encourages bidders to provide recent examples of product testing and previous successful use for the City to properly evaluate the environmental alternative. Testing data from independent accredited organizations are strongly preferred.

<u>Item Number</u>	<u>Description</u>	<u>Add/Deduct Amount</u>
--------------------	--------------------	--------------------------

If the Bidder does not suggest any material or equipment alternate, the Bidder **MUST** complete the following statement:

For the work outlined in this request for bid, the bidder does NOT propose any material or equipment alternate under the Contract.

Signature of Authorized Representative of Bidder _____ Date _____

BID FORM

Section 3 - Time Alternate

If the Bidder takes exception to the time stipulated in Article III of the Contract, Time of Completion, page C-2, it is requested to stipulate below its proposed time for performance of the work. Consideration will be given to time in evaluating bids.

If the Bidder does not suggest any time alternate, the Bidder **MUST** complete the following statement:

For the work outlined in this request for bid, the bidder does NOT propose any time alternate under the Contract.

Signature of Authorized Representative of Bidder _____ Date _____

BID FORM

Section 4 - Major Subcontractors

For purposes of this Contract, a Subcontractor is anyone (other than the Contractor) who performs work (other than or in addition to the furnishing of materials, plans or equipment) at or about the construction site, directly or indirectly for or on behalf of the Contractor (and whether or not in privity of Contract with the Contractor), but shall not include any individual who furnishes merely the individual's own personal labor or services.

Contractor agrees that all subcontracts entered into by the Contractor shall contain similar wage provision to Section 4 of the General Conditions covering subcontractor's employees who perform work on this contract.

For the work outlined in these documents the Bidder expects to engage the following major subcontractors to perform the work identified:

<u>Subcontractor (Name and Address)</u>	<u>Work</u>	<u>Amount</u>
---	-------------	---------------

If the Bidder does not expect to engage any major subcontractor, the Bidder **MUST** complete the following statement:

For the work outlined in this request for bid, the bidder does NOT expect to engage any major subcontractor to perform work under the Contract.

Signature of Authorized Representative of Bidder _____ Date _____

BID FORM

Section 6 – Contractor Information and Responsible Contractor Criteria

Backup documentation may be requested at the sole discretion of the City to validate all of the responses provided herein by bidders. False statements by bidders to any of the criteria provided herein will result in the bid being considered non-responsive and will not be considered for award.

Failure to provide responses to all questions may result in being deemed non-responsive.

Attach additional pages as needed if space below is insufficient.

Pursuant to Sec 1:312(20) of the City Code which sets forth requirements of a responsible bidder, Bidder is required to submit the following:

1. Organization Name: _____

Social Security or Federal Employer I.D. #: _____

Address: _____

City: _____ State: _____ Zip: _____

Type of Organization (circle one below):

Individual Partnership Corporation Joint Venture Other

If "Other" please provide details on the organization:

Year organization established: _____

2. Current owners/principals/members/managing members/partners of the organization:

3. Assumed Names, "doing business as" d/b/a, and/or former organization names(s), if applicable: _____

Explanation of any business name changes:

4. If applicable, please provide a list of all bidder's litigation and arbitrations currently pending and within the past five years, including an explanation of each (parties, court/forum, legal claims, damages sought, and resolution).

5. Qualifications of management and supervisory personnel to be assigned by the bidder:

6. State and local licenses and license numbers held by the bidder:

7. Will all subcontractors, employees and other individuals working on the construction project maintain current applicable licenses required by law for all licensed occupations and professions?

Yes

No

8. Will contractors, subcontractors, employees, and other individuals working on the construction project be misclassified by bidder as independent contractors in violation of state or federal law?

Yes

No

9. Submit a statement as to what percentage of your work force resides within the City of Ann Arbor, and what percentage resides in Washtenaw County, Michigan, and the same information for any major subcontractors.

10. Submit documentation as to employee pay rates.

11. Submit a statement whether bidder provides health insurance, pension or other retirement benefits, paid leave, or other benefits to its employees.

12. Submit a statement explaining bidder's Equal Employment Opportunity Programs for minorities, women, veterans, returning citizens, and small businesses along with supporting documentation or other evidence.

13. Has bidder had any violations of state, federal or local laws or regulations, including OSHA or MIOSHA violations, state or federal prevailing wage laws, wage and hour laws, worker's compensation or unemployment compensation laws, rules or regulations, issued to or against the bidder within the past five years?

Yes

No

If you answered "yes" to the question above, for each violation provide an explanation of the nature of the violation, the agency involved, a violation or reference number, any other individual(s) or party(ies) involved, and the status or outcome and resolution.

14. Does bidder have an existing Fitness for Duty Program (drugs and alcohol testing) of each employee working on the proposed jobsite?

Yes No

15. By attachment, please provide the following:

- Disclosure of any debarment by any federal, state or local governmental unit and/or findings of non-responsibility or non-compliance with respect to any public or private construction project performed by the bidder. Proof of insurance, including certificates of insurance, confirming existence and amount of coverage for liability, property damage, workers compensation, and any other insurances required by the proposed contract documents.

16. Does bidder have an on-going MIOSHA-approved safety-training program for employees to be used on the proposed job site?

Yes No

17. Does bidder have evidence of worker's compensation Experience Modification Rating ("EMR")?

Yes No

EMR = _____

18. Can bidder provide a ratio of masters and journeypersons to apprentices proposed to be used on the construction project job site, documentation of master or journeyperson certification or status and the source for same, and if not, the qualifications of employees who will be assigned to work on the project?

Yes No

If, yes, Ratio = _____

19. Can bidder provide documentation that it participates in a Registered Apprenticeship Program (RAP) that is registered with the United States Department of Labor Office of Apprenticeship or by a State Apprenticeship Agency recognized by the Office of Apprenticeship?

Yes No

If bidder answered "yes" to the question above and is selected for this project, bidder will be required to submit the RAP to the City.

If bidder answered "no" to the question above, please provide details on how your organization assess the skills and qualifications of any employees who do not have master or journeyperson certification or status or are not participants in a Registered Apprenticeship Program identified above.

20. Will bidder comply with all applicable state and federal laws and visa requirements regarding the hiring of non-US citizens, and disclosure of any work visas sought or obtained by the bidder, any of the bidder's subcontractors, or any of the bidder's employees or independent contractors, in order to perform any portion of the project?

Yes

No

21. Can bidder provide audited financial information current within the past twelve (12) months, such as a balance sheet, statement of operations, and bonding capacity?

Yes

No

(Evidence that bidder has financial resources to start up and follow through on the project(s) and to respond to damages in case of default as shown by written verification of bonding capacity equal to or exceeding the amount of the bidder's scope of work on the project. The written verification must be submitted by a licensed surety company rated "B+" (or better) in the current A.M. Best Guide and qualified to do business within the State of Michigan, and the same audited financial information for any subcontractor estimated to be paid more than \$100,000.00 related to any portion of the project.)

22. Can bidder provide evidence of a quality assurance program used by the bidder and the results of any such program on the bidder's previous projects?

Yes

No

SAMPLE STANDARD CONTRACT

If a contract is awarded, the selected contractor will be required to adhere to a set of general contract provisions which will become a part of any formal agreement. These provisions are general principles which apply to all contractors of service to the City of Ann Arbor such as the following:

Administrative Use Only
Contract Date: _____

CONTRACT

THIS CONTRACT is between the CITY OF ANN ARBOR, a Michigan Municipal Corporation, 301 East Huron Street, Ann Arbor, Michigan 48104 ("City") and _____ ("Contractor")

(An individual/partnership/corporation, include state of incorporation) (Address)

Based upon the mutual promises below, the Contractor and the City agree as follows:

ARTICLE I - Scope of Work

The Contractor agrees to furnish all of the materials, equipment and labor necessary; and to abide by all the duties and responsibilities applicable to it for the project titled **Street Resurfacing Project - 2021** and **ITB No. 4667** in accordance with the requirements and provisions of the following documents, including all written modifications incorporated into any of the documents, all of which are incorporated as part of this Contract:

- | | |
|--|-------------------------|
| Living Wage and Non-Discrimination Ordinances -Declaration of Compliance Forms (if applicable) | Bonds |
| Vendor Conflict of Interest Form | General Conditions |
| Prevailing Wage Declaration of Compliance Form (if applicable) | Standard Specifications |
| Bid Forms | Detailed Specifications |
| Contract and Exhibits | Plans |
| | Addenda |

ARTICLE II - Definitions

Administering Service Area/Unit means **Public Services / Engineering**.

Project means **Street Resurfacing Project - 2021** and **ITB No. 4667**.

Supervising Professional means the person acting under the authorization of the manager of the Administering Service Area/Unit. At the time this Contract is executed, the Supervising Professional is: **David Dykman, P.E.** whose job title is **Project Manager**. If there is any question concerning who the Supervising Professional is, Contractor shall confirm with the manager of the Administering Service Area/Unit.

Contractor's Representative means _____ **[Insert name]** whose job title is **[Insert job title]**.

ARTICLE III - Time of Completion

- (A) The work to be completed under this Contract shall begin immediately on the date specified in the Notice to Proceed issued by the City.
- (B) The entire work for this Contract shall be completed within _____ () consecutive calendar days.
- (C) Failure to complete all the work within the time specified above, including any extension granted in writing by the Supervising Professional, shall obligate the Contractor to pay the City, as liquidated damages and not as a penalty, an amount equal to \$_____ for each calendar day of delay in the completion of all the work. If any liquidated damages are unpaid by the Contractor, the City shall be entitled to deduct these unpaid liquidated damages from the monies due the Contractor.

The liquidated damages are for the non-quantifiable aspects of any of the previously identified events and do not cover actual damages that can be shown or quantified nor are they intended to preclude recovery of actual damages in addition to the recovery of liquidated damages.

ARTICLE IV - The Contract Sum

- (A) The City shall pay to the Contractor for the performance of the Contract, the unit prices as given in the Bid Form for the estimated bid total of:

_____ Dollars (\$_____)
- (B) The amount paid shall be equitably adjusted to cover changes in the work ordered by the Supervising Professional but not required by the Contract Documents. Increases or decreases shall be determined only by written agreement between the City and Contractor.

ARTICLE V - Assignment

This Contract may not be assigned or subcontracted any portion of any right or obligation under this contract without the written consent of the City. Notwithstanding any consent by the City to any assignment, Contractor shall at all times remain bound to all warranties, certifications, indemnifications, promises and performances, however described, as are required of it under this contract unless specifically released from the requirement, in writing, by the City.

ARTICLE VI - Choice of Law

This Contract shall be construed, governed, and enforced in accordance with the laws of the State of Michigan. By executing this Contract, the Contractor and the City agree to venue in a court of appropriate jurisdiction sitting within Washtenaw County for purposes of any action arising under this Contract. The parties stipulate that the venue referenced in this Contract is for convenience and waive any claim of non-convenience.

Whenever possible, each provision of the Contract will be interpreted in a manner as to be effective and valid under applicable law. The prohibition or invalidity, under applicable law, of any provision will not invalidate the remainder of the Contract.

ARTICLE VII - Relationship of the Parties

The parties of the Contract agree that it is not a Contract of employment but is a Contract to accomplish a specific result. Contractor is an independent Contractor performing services for the City. Nothing contained in this Contract shall be deemed to constitute any other relationship between the City and the Contractor.

Contractor certifies that it has no personal or financial interest in the project other than the compensation it is to receive under the Contract. Contractor certifies that it is not, and shall not become, overdue or in default to the City for any Contract, debt, or any other obligation to the City including real or personal property taxes. City shall have the right to set off any such debt against compensation awarded for services under this Contract.

ARTICLE VIII - Notice

All notices given under this Contract shall be in writing, and shall be by personal delivery or by certified mail with return receipt requested to the parties at their respective addresses as specified in the Contract Documents or other address the Contractor may specify in writing. Notice will be deemed given on the date when one of the following first occur: (1) the date of actual receipt; or (2) three days after mailing certified U.S. mail.

ARTICLE IX - Indemnification

To the fullest extent permitted by law, Contractor shall indemnify, defend and hold the City, its officers, employees and agents harmless from all suits, claims, judgments and expenses including attorney's fees resulting or alleged to result, in whole or in part, from any act or omission, which is in any way connected or associated with this Contract, by the Contractor or anyone acting on the Contractor's behalf under this Contract. Contractor shall not be responsible to indemnify the City for losses or damages caused by or resulting from the City's sole negligence. The provisions of this Article shall survive the expiration or earlier termination of this contract for any reason.

ARTICLE X - Entire Agreement

This Contract represents the entire understanding between the City and the Contractor and it supersedes all prior representations, negotiations, agreements, or understandings whether written or oral. Neither party has relied on any prior representations in entering into this Contract. No terms or conditions of either party's invoice, purchase order or other administrative document shall modify the terms and conditions of this Contract, regardless of the other party's failure to object to such form. This Contract shall be binding on and shall inure to the benefit of the parties to this Contract and their permitted successors and permitted assigns and nothing in this Contract, express or implied, is intended to or shall confer on any other person or entity any legal or equitable right, benefit, or remedy of any nature whatsoever under or by reason of this Contract. This Contract may be altered, amended or modified only by written amendment signed by the City and the Contractor.

ARTICLE XI – Electronic Transactions

The City and Contractor agree that signatures on this Contract may be delivered electronically in lieu of an original signature and agree to treat electronic signatures as original signatures that bind them to this Contract. This Contract may be executed and delivered by facsimile and upon such delivery, the facsimile signature will be deemed to have the same effect as if the original signature had been delivered to the other party.

FOR CONTRACTOR

By _____

Its: _____

FOR THE CITY OF ANN ARBOR

By _____
Christopher Taylor, Mayor

By _____
Jacqueline Beaudry, City Clerk

Approved as to substance

By _____
Tom Crawford, City Administrator

By _____
Craig Hupy, Services Area Administrator

Approved as to form and content

Stephen K. Postema, City Attorney

PERFORMANCE BOND

- (1) _____ of _____ (referred to as "Principal"), and _____, a corporation duly authorized to do business in the State of Michigan (referred to as "Surety"), are bound to the City of Ann Arbor, Michigan (referred to as "City"), for \$ _____, the payment of which Principal and Surety bind themselves, their heirs, executors, administrators, successors and assigns, jointly and severally, by this bond.
- (2) The Principal has entered a written Contract with the City entitled _____, for ITB No. _____ and this bond is given for that Contract in compliance with Act No. 213 of the Michigan Public Acts of 1963, as amended, being MCL 129.201 *et seq.*
- (3) Whenever the Principal is declared by the City to be in default under the Contract, the Surety may promptly remedy the default or shall promptly:
 - (a) complete the Contract in accordance with its terms and conditions; or
 - (b) obtain a bid or bids for submission to the City for completing the Contract in accordance with its terms and conditions, and upon determination by Surety of the lowest responsible bidder, arrange for a Contract between such bidder and the City, and make available, as work progresses, sufficient funds to pay the cost of completion less the balance of the Contract price; but not exceeding, including other costs and damages for which Surety may be liable hereunder, the amount set forth in paragraph 1.
- (4) Surety shall have no obligation to the City if the Principal fully and promptly performs under the Contract.
- (5) Surety agrees that no change, extension of time, alteration or addition to the terms of the Contract or to the work to be performed thereunder, or the specifications accompanying it shall in any way affect its obligations on this bond, and waives notice of any such change, extension of time, alteration or addition to the terms of the Contract or to the work, or to the specifications.
- (6) Principal, Surety, and the City agree that signatures on this bond may be delivered electronically in lieu of an original signature and agree to treat electronic signatures as original signatures that bind them to this bond. This bond may be executed and delivered by facsimile and upon such delivery, the facsimile signature will be deemed to have the same effect as if the original signature had been delivered to the other party.

SIGNED AND SEALED this _____ day of _____, 202_.

(Name of Surety Company)
By _____
(Signature)
Its _____
(Title of Office)

(Name of Principal)
By _____
(Signature)
Its _____
(Title of Office)

Approved as to form:

Name and address of agent:

Stephen K. Postema, City Attorney

LABOR AND MATERIAL BOND

- (1) _____
of _____ (referred to as
"Principal"), and _____, a corporation duly authorized
to do business in the State of Michigan, (referred to as "Surety"), are bound to the City of Ann Arbor,
Michigan (referred to as "City"), for the use and benefit of claimants as defined in Act 213 of Michigan
Public Acts of 1963, as amended, being MCL 129.201 et seq., in the amount of
\$ _____, for the payment of which Principal and Surety bind themselves, their heirs,
executors, administrators, successors and assigns, jointly and severally, by this bond.
- (2) The Principal has entered a written Contract with the City entitled _____

_____, for ITB No. _____; and this bond is
given for that Contract in compliance with Act No. 213 of the Michigan Public Acts of 1963 as amended;
- (3) If the Principal fails to promptly and fully repay claimants for labor and material reasonably required
under the Contract, the Surety shall pay those claimants.
- (4) Surety's obligations shall not exceed the amount stated in paragraph 1, and Surety shall have no
obligation if the Principal promptly and fully pays the claimants.
- (5) Principal, Surety, and the City agree that signatures on this bond may be delivered electronically in lieu
of an original signature and agree to treat electronic signatures as original signatures that bind them to
this bond. This bond may be executed and delivered by facsimile and upon such delivery, the facsimile
signature will be deemed to have the same effect as if the original signature had been delivered to the
other party.

SIGNED AND SEALED this _____ day of _____, 202__

(Name of Surety Company)

By _____
(Signature)

Its _____
(Title of Office)

Approved as to form:

Stephen K. Postema, City Attorney

(Name of Principal)

By _____
(Signature)

Its _____
(Title of Office)

Name and address of agent:

GENERAL CONDITIONS

Section 1 - Execution, Correlation and Intent of Documents

The contract documents shall be signed in 2 copies by the City and the Contractor.

The contract documents are complementary and what is called for by any one shall be binding. The intention of the documents is to include all labor and materials, equipment and transportation necessary for the proper execution of the work. Materials or work described in words which so applied have a well-known technical or trade meaning have the meaning of those recognized standards.

In case of a conflict among the contract documents listed below in any requirement(s), the requirement(s) of the document listed first shall prevail over any conflicting requirement(s) of a document listed later.

(1) Addenda in reverse chronological order; (2) Detailed Specifications; (3) Standard Specifications; (4) Plans; (5) General Conditions; (6) Contract; (7) Bid Forms; (8) Bond Forms; (9) Bid.

Section 2 - Order of Completion

The Contractor shall submit with each invoice, and at other times reasonably requested by the Supervising Professional, schedules showing the order in which the Contractor proposes to carry on the work. They shall include the dates at which the Contractor will start the several parts of the work, the estimated dates of completion of the several parts, and important milestones within the several parts.

Section 3 - Familiarity with Work

The Bidder or its representative shall make personal investigations of the site of the work and of existing structures and shall determine to its own satisfaction the conditions to be encountered, the nature of the ground, the difficulties involved, and all other factors affecting the work proposed under this Contract. The Bidder to whom this Contract is awarded will not be entitled to any additional compensation unless conditions are clearly different from those which could reasonably have been anticipated by a person making diligent and thorough investigation of the site.

The Bidder shall immediately notify the City upon discovery, and in every case prior to submitting its Bid, of every error or omission in the bidding documents that would be identified by a reasonably competent, diligent Bidder. In no case will a Bidder be allowed the benefit of extra compensation or time to complete the work under this Contract for extra expenses or time spent as a result of the error or omission.

Section 4 - Wage Requirements

Under this Contract, the Contractor shall conform to Chapter 14 of Title I of the Code of the City of Ann Arbor as amended; which in part states "...that all craftsmen, mechanics and laborers employed directly on the site in connection with said improvements, including said employees of subcontractors, shall receive the prevailing wage for the corresponding classes of craftsmen, mechanics and laborers, as determined by statistics for the Ann Arbor area compiled by the United States Department of Labor. At the request of the City, any contractor or subcontractor shall provide satisfactory proof of compliance with the contract provisions required by the Section.

Pursuant to Resolution R-16-469 all public improvement contractors are subject to prevailing wage and will be required to provide to the City payroll records sufficient to demonstrate compliance with the prevailing wage requirements. A sample Prevailing Wage Form is provided in the Appendix herein for reference as to what will be expected from contractors. Use of the Prevailing Wage Form provided in the Appendix section or a City-approved equivalent will be required along with wage rate interviews.

Where the Contract and the Ann Arbor City Ordinance are silent as to definitions of terms required in determining contract compliance with regard to prevailing wages, the definitions provided in the Davis-Bacon Act as amended (40 U.S.C. 278-a to 276-a-7) for the terms shall be used.

If the Contractor is a "covered employer" as defined in Chapter 23 of the Ann Arbor City Code, the Contractor agrees to comply with the living wage provisions of Chapter 23 of the Ann Arbor City Code. The Contractor agrees to pay those employees providing Services to the City under this Contract a "living wage," as defined in Section 1:815 of the Ann Arbor City Code, as adjusted in accordance with Section 1:815(3); to post a notice approved by the City of the applicability of Chapter 23 in every location in which regular or contract employees providing services under this Contract are working; to maintain records of compliance; if requested by the City, to provide documentation to verify compliance; to take no action that would reduce the compensation, wages, fringe benefits, or leave available to any employee or person contracted for employment in order to pay the living wage required by Section 1:815; and otherwise to comply with the requirements of Chapter 23.

Contractor agrees that all subcontracts entered into by the Contractor shall contain similar wage provision covering subcontractor's employees who perform work on this contract.

Section 5 - Non-Discrimination

The Contractor agrees to comply, and to require its subcontractor(s) to comply, with the nondiscrimination provisions of MCL 37.2209. The Contractor further agrees to comply with the provisions of Section 9:158 of Chapter 112 of Title IX of the Ann Arbor City Code, and to assure that applicants are employed and that employees are treated during employment in a manner which provides equal employment opportunity.

Section 6 - Materials, Appliances, Employees

Unless otherwise stipulated, the Contractor shall provide and pay for all materials, labor, water, tools, equipment, light, power, transportation, and other facilities necessary or used for the execution and completion of the work. Unless otherwise specified, all materials incorporated in the permanent work shall be new, and both workmanship and materials shall be of the highest quality. The Contractor shall, if required, furnish satisfactory evidence as to the kind and quality of materials.

The Contractor shall at all times enforce strict discipline and good order among its employees, and shall seek to avoid employing on the work any unfit person or anyone not skilled in the work assigned.

Adequate sanitary facilities shall be provided by the Contractor.

Section 7 - Qualifications for Employment

The Contractor shall employ competent laborers and mechanics for the work under this Contract. For work performed under this Contract, employment preference shall be given to qualified local residents.

Section 8 - Royalties and Patents

The Contractor shall pay all royalties and license fees. It shall defend all suits or claims for infringements of any patent rights and shall hold the City harmless from loss on account of infringement except that the City shall be responsible for all infringement loss when a particular process or the product of a particular manufacturer or manufacturers is specified, unless the City has notified the Contractor prior to the signing of the Contract that the particular process or product is patented or is believed to be patented.

Section 9 - Permits and Regulations

The Contractor must secure and pay for all permits, permit or plan review fees and licenses necessary for the prosecution of the work. These include but are not limited to City building permits, right-of-way permits, lane closure permits, right-of-way occupancy permits, and the like. The City shall secure and pay for easements shown on the plans unless otherwise specified.

The Contractor shall give all notices and comply with all laws, ordinances, rules and regulations bearing on the conduct of the work as drawn and specified. If the Contractor observes that the contract documents are at variance with those requirements, it shall promptly notify the Supervising Professional in writing, and any necessary changes shall be adjusted as provided in the Contract for changes in the work.

Section 10 - Protection of the Public and of Work and Property

The Contractor is responsible for the means, methods, sequences, techniques and procedures of construction and safety programs associated with the work contemplated by this contract. The Contractor, its agents or sub-contractors, shall comply with the "General Rules and Regulations for the Construction Industry" as published by the Construction Safety Commission of the State of Michigan and to all other local, State and National laws, ordinances, rules and regulations pertaining to safety of persons and property.

The Contractor shall take all necessary and reasonable precautions to protect the safety of the public. It shall continuously maintain adequate protection of all work from damage, and shall take all necessary and reasonable precautions to adequately protect all public and private property from injury or loss arising in connection with this Contract. It shall make good any damage, injury or loss to its work and to public and private property resulting from lack of reasonable protective precautions, except as may be due to errors in the contract documents, or caused by agents or employees of the City. The Contractor shall obtain and maintain sufficient insurance to cover damage to any City property at the site by any cause.

In an emergency affecting the safety of life, or the work, or of adjoining property, the Contractor is, without special instructions or authorization from the Supervising Professional, permitted to act at its discretion to prevent the threatened loss or injury. It shall also so act, without appeal, if authorized or instructed by the Supervising Professional.

Any compensation claimed by the Contractor for emergency work shall be determined by agreement or in accordance with the terms of Claims for Extra Cost - Section 15.

Section 11 - Inspection of Work

The City shall provide sufficient competent personnel for the inspection of the work.

The Supervising Professional shall at all times have access to the work whenever it is in preparation or progress, and the Contractor shall provide proper facilities for access and for inspection.

If the specifications, the Supervising Professional's instructions, laws, ordinances, or any public authority require any work to be specially tested or approved, the Contractor shall give the Supervising Professional timely notice of its readiness for inspection, and if the inspection is by an authority other than the Supervising Professional, of the date fixed for the inspection. Inspections by the Supervising Professional shall be made promptly, and where practicable at the source of supply. If any work should be covered up without approval or consent of the Supervising Professional, it must, if required by the Supervising Professional, be uncovered for examination and properly restored at the Contractor's expense.

Re-examination of any work may be ordered by the Supervising Professional, and, if so ordered, the work must be uncovered by the Contractor. If the work is found to be in accordance with the contract documents, the City shall pay the cost of re-examination and replacement. If the work is not in accordance with the contract documents, the Contractor shall pay the cost.

Section 12 - Superintendence

The Contractor shall keep on the work site, during its progress, a competent superintendent and any necessary assistants, all satisfactory to the Supervising Professional. The superintendent will be responsible to perform all on-site project management for the Contractor. The superintendent shall be experienced in the work required for this Contract. The superintendent shall represent the Contractor and all direction given to the superintendent shall be binding as if given to the Contractor. Important directions shall immediately be confirmed in writing to the Contractor. Other directions will be confirmed on written request. The Contractor shall give efficient superintendence to the work, using its best skill and attention.

Section 13 - Changes in the Work

The City may make changes to the quantities of work within the general scope of the Contract at any time by a written order and without notice to the sureties. If the changes add to or deduct from the extent of the work, the Contract Sum shall be adjusted accordingly. All the changes shall be executed under the conditions of the original Contract except that any claim for extension of time caused by the change shall be adjusted at the time of ordering the change.

In giving instructions, the Supervising Professional shall have authority to make minor changes in the work not involving extra cost and not inconsistent with the purposes of the work, but otherwise, except in an emergency endangering life or property, no extra work or change shall be made unless in pursuance of a written order by the Supervising Professional, and no claim for an addition to the Contract Sum shall be valid unless the additional work was ordered in writing.

The Contractor shall proceed with the work as changed and the value of the work shall be determined as provided in Claims for Extra Cost - Section 15.

Section 14 - Extension of Time

Extension of time stipulated in the Contract for completion of the work will be made if and as the Supervising Professional may deem proper under any of the following circumstances:

- (1) When work under an extra work order is added to the work under this Contract;
- (2) When the work is suspended as provided in Section 20;
- (3) When the work of the Contractor is delayed on account of conditions which could not have been foreseen, or which were beyond the control of the Contractor, and which were not the result of its fault or negligence;
- (4) Delays in the progress of the work caused by any act or neglect of the City or of its employees or by other Contractors employed by the City;
- (5) Delay due to an act of Government;
- (6) Delay by the Supervising Professional in the furnishing of plans and necessary information;

- (7) Other cause which in the opinion of the Supervising Professional entitles the Contractor to an extension of time.

The Contractor shall notify the Supervising Professional within 7 days of an occurrence or conditions which, in the Contractor's opinion, entitle it to an extension of time. The notice shall be in writing and submitted in ample time to permit full investigation and evaluation of the Contractor's claim. The Supervising Professional shall acknowledge receipt of the Contractor's notice within 7 days of its receipt. Failure to timely provide the written notice shall constitute a waiver by the Contractor of any claim.

In situations where an extension of time in contract completion is appropriate under this or any other section of the contract, the Contractor understands and agrees that the only available adjustment for events that cause any delays in contract completion shall be extension of the required time for contract completion and that there shall be no adjustments in the money due the Contractor on account of the delay.

Section 15 - Claims for Extra Cost

If the Contractor claims that any instructions by drawings or other media issued after the date of the Contract involved extra cost under this Contract, it shall give the Supervising Professional written notice within 7 days after the receipt of the instructions, and in any event before proceeding to execute the work, except in emergency endangering life or property. The procedure shall then be as provided for Changes in the Work-Section I3. No claim shall be valid unless so made.

If the Supervising Professional orders, in writing, the performance of any work not covered by the contract documents, and for which no item of work is provided in the Contract, and for which no unit price or lump sum basis can be agreed upon, then the extra work shall be done on a Cost-Plus-Percentage basis of payment as follows:

- (1) The Contractor shall be reimbursed for all reasonable costs incurred in doing the work, and shall receive an additional payment of 15% of all the reasonable costs to cover both its indirect overhead costs and profit;
- (2) The term "Cost" shall cover all payroll charges for employees and supervision required under the specific order, together with all worker's compensation, Social Security, pension and retirement allowances and social insurance, or other regular payroll charges on same; the cost of all material and supplies required of either temporary or permanent character; rental of all power-driven equipment at agreed upon rates, together with cost of fuel and supply charges for the equipment; and any costs incurred by the Contractor as a direct result of executing the order, if approved by the Supervising Professional;
- (3) If the extra is performed under subcontract, the subcontractor shall be allowed to compute its charges as described above. The Contractor shall be permitted to add an additional charge of 5% percent to that of the subcontractor for the Contractor's supervision and contractual responsibility;
- (4) The quantities and items of work done each day shall be submitted to the Supervising Professional in a satisfactory form on the succeeding day, and shall be approved by the Supervising Professional and the Contractor or adjusted at once;

- (5) Payments of all charges for work under this Section in any one month shall be made along with normal progress payments. Retainage shall be in accordance with Progress Payments-Section 16.

No additional compensation will be provided for additional equipment, materials, personnel, overtime or special charges required to perform the work within the time requirements of the Contract.

When extra work is required and no suitable price for machinery and equipment can be determined in accordance with this Section, the hourly rate paid shall be 1/40 of the basic weekly rate listed in the Rental Rate Blue Book published by Dataquest Incorporated and applicable to the time period the equipment was first used for the extra work. The hourly rate will be deemed to include all costs of operation such as bucket or blade, fuel, maintenance, "regional factors", insurance, taxes, and the like, but not the costs of the operator.

Section 16 - Progress Payments

The Contractor shall submit each month, or at longer intervals, if it so desires, an invoice covering work performed for which it believes payment, under the Contract terms, is due. The submission shall be to the City's Finance Department - Accounting Division. The Supervising Professional will, within 10 days following submission of the invoice, prepare a certificate for payment for the work in an amount to be determined by the Supervising Professional as fairly representing the acceptable work performed during the period covered by the Contractor's invoice. To insure the proper performance of this Contract, the City will retain a percentage of the estimate in accordance with Act 524, Public Acts of 1980. The City will then, following the receipt of the Supervising Professional's Certificate, make payment to the Contractor as soon as feasible, which is anticipated will be within 15 days.

An allowance may be made in progress payments if substantial quantities of permanent material have been delivered to the site but not incorporated in the completed work if the Contractor, in the opinion of the Supervising Professional, is diligently pursuing the work under this Contract. Such materials shall be properly stored and adequately protected. Allowance in the estimate shall be at the invoice price value of the items. Notwithstanding any payment of any allowance, all risk of loss due to vandalism or any damages to the stored materials remains with the Contractor.

In the case of Contracts which include only the Furnishing and Delivering of Equipment, the payments shall be; 60% of the Contract Sum upon the delivery of all equipment to be furnished, or in the case of delivery of a usable portion of the equipment in advance of the total equipment delivery, 60% of the estimated value of the portion of the equipment may be paid upon its delivery in advance of the time of the remainder of the equipment to be furnished; 30% of the Contract Sum upon completion of erection of all equipment furnished, but not later than 60 days after the date of delivery of all of the equipment to be furnished; and payment of the final 10% on final completion of erection, testing and acceptance of all the equipment to be furnished; but not later than 180 days after the date of delivery of all of the equipment to be furnished, unless testing has been completed and shows the equipment to be unacceptable.

With each invoice for periodic payment, the Contractor shall enclose a Contractor's Declaration - Section 43, and an updated project schedule per Order of Completion - Section 2.

Section 17 - Deductions for Uncorrected Work

If the Supervising Professional decides it is inexpedient to correct work that has been damaged or that was not done in accordance with the Contract, an equitable deduction from the Contract price shall be made.

Section 18 - Correction of Work Before Final Payment

The Contractor shall promptly remove from the premises all materials condemned by the Supervising Professional as failing to meet Contract requirements, whether incorporated in the work or not, and the Contractor shall promptly replace and re-execute the work in accordance with the Contract and without expense to the City and shall bear the expense of making good all work of other contractors destroyed or damaged by the removal or replacement.

If the Contractor does not remove the condemned work and materials within 10 days after written notice, the City may remove them and, if the removed material has value, may store the material at the expense of the Contractor. If the Contractor does not pay the expense of the removal within 10 days thereafter, the City may, upon 10 days written notice, sell the removed materials at auction or private sale and shall pay to the Contractor the net proceeds, after deducting all costs and expenses that should have been borne by the Contractor. If the removed material has no value, the Contractor must pay the City the expenses for disposal within 10 days of invoice for the disposal costs.

The inspection or lack of inspection of any material or work pertaining to this Contract shall not relieve the Contractor of its obligation to fulfill this Contract and defective work shall be made good. Unsuitable materials may be rejected by the Supervising Professional notwithstanding that the work and materials have been previously overlooked by the Supervising Professional and accepted or estimated for payment or paid for. If the work or any part shall be found defective at any time before the final acceptance of the whole work, the Contractor shall forthwith make good the defect in a manner satisfactory to the Supervising Professional. The judgment and the decision of the Supervising Professional as to whether the materials supplied and the work done under this Contract comply with the requirements of the Contract shall be conclusive and final.

Section 19 - Acceptance and Final Payment

Upon receipt of written notice that the work is ready for final inspection and acceptance, the Supervising Professional will promptly make the inspection. When the Supervising Professional finds the work acceptable under the Contract and the Contract fully performed, the Supervising Professional will promptly sign and issue a final certificate stating that the work required by this Contract has been completed and is accepted by the City under the terms and conditions of the Contract. The entire balance found to be due the Contractor, including the retained percentage, shall be paid to the Contractor by the City within 30 days after the date of the final certificate.

Before issuance of final certificates, the Contractor shall file with the City:

- (1) The consent of the surety to payment of the final estimate;
- (2) The Contractor's Affidavit in the form required by Section 44.

In case the Affidavit or consent is not furnished, the City may retain out of any amount due the Contractor, sums sufficient to cover all lienable claims.

The making and acceptance of the final payment shall constitute a waiver of all claims by the City except those arising from:

- (1) unsettled liens;
- (2) faulty work appearing within 12 months after final payment;
- (3) hidden defects in meeting the requirements of the plans and specifications;
- (4) manufacturer's guarantees.

It shall also constitute a waiver of all claims by the Contractor, except those previously made and still unsettled.

Section 20 - Suspension of Work

The City may at any time suspend the work, or any part by giving 5 days notice to the Contractor in writing. The work shall be resumed by the Contractor within 10 days after the date fixed in the written notice from the City to the Contractor to do so. The City shall reimburse the Contractor for expense incurred by the Contractor in connection with the work under this Contract as a result of the suspension.

If the work, or any part, shall be stopped by the notice in writing, and if the City does not give notice in writing to the Contractor to resume work at a date within 90 days of the date fixed in the written notice to suspend, then the Contractor may abandon that portion of the work suspended and will be entitled to the estimates and payments for all work done on the portions abandoned, if any, plus 10% of the value of the work abandoned, to compensate for loss of overhead, plant expense, and anticipated profit.

Section 21 - Delays and the City's Right to Terminate Contract

If the Contractor refuses or fails to prosecute the work, or any separate part of it, with the diligence required to insure completion, ready for operation, within the allowable number of consecutive calendar days specified plus extensions, or fails to complete the work within the required time, the City may, by written notice to the Contractor, terminate its right to proceed with the work or any part of the work as to which there has been delay. After providing the notice the City may take over the work and prosecute it to completion, by contract or otherwise, and the Contractor and its sureties shall be liable to the City for any excess cost to the City. If the Contractor's right to proceed is terminated, the City may take possession of and utilize in completing the work, any materials, appliances and plant as may be on the site of the work and useful for completing the work. The right of the Contractor to proceed shall not be terminated or the Contractor charged with liquidated damages where an extension of time is granted under Extension of Time - Section 14.

If the Contractor is adjudged a bankrupt, or if it makes a general assignment for the benefit of creditors, or if a receiver is appointed on account of its insolvency, or if it persistently or repeatedly refuses or fails except in cases for which extension of time is provided, to supply enough properly skilled workers or proper materials, or if it fails to make prompt payments to subcontractors or for material or labor, or persistently disregards laws, ordinances or the instructions of the Supervising Professional, or otherwise is guilty of a substantial violation of any provision of the Contract, then the City, upon the certificate of the Supervising Professional that sufficient cause exists to justify such action, may, without prejudice to any other right or remedy and after giving the Contractor 3 days written notice, terminate this Contract. The City may then take possession of the premises and of all materials, tools and appliances thereon and without prejudice to any other remedy it may have, make good the deficiencies or finish the work by whatever method it may deem expedient, and deduct the cost from the payment due the Contractor. The Contractor shall not be entitled to receive any further payment until the work is finished. If the expense of finishing the work, including compensation for additional managerial and administrative services exceeds the unpaid balance of the Contract Sum, the Contractor and its surety are liable to the City for any excess cost incurred. The expense incurred by the City, and the damage incurred through the Contractor's default, shall be certified by the Supervising Professional.

Section 22 - Contractor's Right to Terminate Contract

If the work should be stopped under an order of any court, or other public authority, for a period of 3 months, through no act or fault of the Contractor or of anyone employed by it, then the Contractor may, upon 7 days written notice to the City, terminate this Contract and recover from the City payment for all acceptable work executed plus reasonable profit.

Section 23 - City's Right To Do Work

If the Contractor should neglect to prosecute the work properly or fail to perform any provision of this Contract, the City, 3 days after giving written notice to the Contractor and its surety may, without prejudice to any other remedy the City may have, make good the deficiencies and may deduct the cost from the payment due to the Contractor.

Section 24 - Removal of Equipment and Supplies

In case of termination of this Contract before completion, from any or no cause, the Contractor, if notified to do so by the City, shall promptly remove any part or all of its equipment and supplies from the property of the City, failing which the City shall have the right to remove the equipment and supplies at the expense of the Contractor.

The removed equipment and supplies may be stored by the City and, if all costs of removal and storage are not paid by the Contractor within 10 days of invoicing, the City upon 10 days written notice may sell the equipment and supplies at auction or private sale, and shall pay the Contractor the net proceeds after deducting all costs and expenses that should have been borne by the Contractor and after deducting all amounts claimed due by any lien holder of the equipment or supplies.

Section 25 - Responsibility for Work and Warranties

The Contractor assumes full responsibility for any and all materials and equipment used in the construction of the work and may not make claims against the City for damages to materials and equipment from any cause except negligence or willful act of the City. Until its final acceptance, the Contractor shall be responsible for damage to or destruction of the project (except for any part covered by Partial Completion and Acceptance - Section 26). The Contractor shall make good all work damaged or destroyed before acceptance. All risk of loss remains with the Contractor until final acceptance of the work (Section 19) or partial acceptance (Section 26). The Contractor is advised to investigate obtaining its own builders risk insurance.

The Contractor shall guarantee the quality of the work for a period of one year. The Contractor shall also unconditionally guarantee the quality of all equipment and materials that are furnished and installed under the contract for a period of one year. At the end of one year after the Contractor's receipt of final payment, the complete work, including equipment and materials furnished and installed under the contract, shall be inspected by the Contractor and the Supervising Professional. Any defects shall be corrected by the Contractor at its expense as soon as practicable but in all cases within 60 days. Any defects that are identified prior to the end of one year shall also be inspected by the Contractor and the Supervising Professional and shall be corrected by the Contractor at its expense as soon as practicable but in all cases within 60 days. The Contractor shall assign all manufacturer or material supplier warranties to the City prior to final payment. The assignment shall not relieve the Contractor of its obligations under this paragraph to correct defects.

Section 26 - Partial Completion and Acceptance

If at any time prior to the issuance of the final certificate referred to in Acceptance and Final Payment - Section 19, any portion of the permanent construction has been satisfactorily completed, and if the Supervising Professional determines that portion of the permanent construction is not required for the operations of the Contractor but is needed by the City, the Supervising Professional shall issue to the Contractor a certificate of partial completion, and immediately the City may take over and use the portion of the permanent construction described in the certificate, and exclude the Contractor from that portion.

The issuance of a certificate of partial completion shall not constitute an extension of the Contractor's time to complete the portion of the permanent construction to which it relates if the Contractor has failed to complete it in accordance with the terms of this Contract. The issuance of the certificate shall not release the Contractor or its sureties from any obligations under this Contract including bonds.

If prior use increases the cost of, or delays the work, the Contractor shall be entitled to extra compensation, or extension of time, or both, as the Supervising Professional may determine.

Section 27 - Payments Withheld Prior to Final Acceptance of Work

The City may withhold or, on account of subsequently discovered evidence, nullify the whole or part of any certificate to the extent reasonably appropriate to protect the City from loss on account of:

- (1) Defective work not remedied;

- (2) Claims filed or reasonable evidence indicating probable filing of claims by other parties against the Contractor;
- (3) Failure of the Contractor to make payments properly to subcontractors or for material or labor;
- (4) Damage to another Contractor.

When the above grounds are removed or the Contractor provides a Surety Bond satisfactory to the City which will protect the City in the amount withheld, payment shall be made for amounts withheld under this section.

Section 28 - Contractor's Insurance

- (1) The Contractor shall procure and maintain during the life of this Contract, including the guarantee period and during any warranty work, such insurance policies, including those set forth below, as will protect itself and the City from all claims for bodily injuries, death or property damage that may arise under this Contract; whether the act(s) or omission(s) giving rise to the claim were made by the Contractor, any subcontractor, or anyone employed by them directly or indirectly. Prior to commencement of any work under this contract, Contractor shall provide to the City documentation satisfactory to the City, through City-approved means (currently myCOI), demonstrating it has obtained the required policies and endorsements. The certificates of insurance endorsements and/or copies of policy language shall document that the Contractor satisfies the following minimum requirements. Contractor shall add registration@mycoitracking.com to its safe sender's list so that it will receive necessary communication from myCOI. When requested, Contractor shall provide the same documentation for its subcontractor(s) (if any).

Required insurance policies include:

- (a) Worker's Compensation Insurance in accordance with all applicable state and federal statutes. Further, Employers Liability Coverage shall be obtained in the following minimum amounts:

- Bodily Injury by Accident - \$500,000 each accident
- Bodily Injury by Disease - \$500,000 each employee
- Bodily Injury by Disease - \$500,000 each policy limit

- (b) Commercial General Liability Insurance equivalent to, as a minimum, Insurance Services Office form CG 00 01 04 13 or current equivalent. The City of Ann Arbor shall be named as an additional insured. There shall be no added exclusions or limiting endorsements specifically for the following coverages: Products and Completed Operations, Explosion, Collapse and Underground coverage or Pollution. Further there shall be no added exclusions or limiting endorsements that diminish the City's protections as an additional insured under the policy. The following minimum limits of liability are required:

- \$1,000,000 Each occurrence as respect Bodily Injury Liability or Property Damage Liability, or both combined.

\$2,000,000	Per Project General Aggregate
\$1,000,000	Personal and Advertising Injury
\$2,000,000	Products and Completed Operations Aggregate

- (c) Motor Vehicle Liability Insurance, including Michigan No-Fault Coverages, equivalent to, as a minimum, Insurance Services Office form CA 00 01 10 13 or current equivalent. Coverage shall include all owned vehicles, all non-owned vehicles and all hired vehicles. The City of Ann Arbor shall be named as an additional insured. There shall be no added exclusions or limiting endorsements that diminish the City's protections as an additional insured under the policy. Further, the limits of liability shall be \$1,000,000 for each occurrence as respects Bodily Injury Liability or Property Damage Liability, or both combined.
- (d) Umbrella/Excess Liability Insurance shall be provided to apply excess of the Commercial General Liability, Employers Liability and the Motor Vehicle coverage enumerated above, for each occurrence and for aggregate in the amount of \$1,000,000.
- (2) Insurance required under subsection (1)(b) and (1)(c) above shall be considered primary as respects any other valid or collectible insurance that the City may possess, including any self-insured retentions the City may have; and any other insurance the City does possess shall be considered excess insurance only and shall not be required to contribute with this insurance. Further, the Contractor agrees to waive any right of recovery by its insurer against the City for any insurance listed herein.
- (3) Insurance companies and policy forms are subject to approval of the City Attorney, which approval shall not be unreasonably withheld. Documentation must provide and demonstrate an unconditional and un-qualified 30-day written notice of cancellation in favor of the City of Ann Arbor. Further, the documentation must explicitly state the following: (a) the policy number(s); name of insurance company(s); name and address of the agent(s) or authorized representative(s); name(s), email address(es), and address of insured; project name; policy expiration date; and specific coverage amounts; (b) any deductibles or self-insured retentions which may be approved by the City, in its sole discretion; (c) that the policy conforms to the requirements specified Contractor shall furnish the City with satisfactory certificates of insurance and endorsements prior to commencement of any work. Upon request, the Contractor shall provide within 30 days a copy of the policy(ies) and all required endorsements to the City. If any of the above coverages expire by their terms during the term of this Contract, the Contractor shall deliver proof of renewal and/or new policies and endorsements to the Administering Service Area/Unit at least ten days prior to the expiration date.
- (4) Any Insurance provider of Contractor shall be authorized to do business in the State of Michigan and shall carry and maintain a minimum rating assigned by A.M. Best & Company's Key Rating Guide of "A-" Overall and a minimum Financial Size Category of "V". Insurance policies and certificates issued by non-authorized insurance companies are not acceptable unless approved in writing by the City.
- (5) City reserves the right to require additional coverage and/or coverage amounts as may be included from time to time in the Detailed Specifications for the Project.

- (6) The provisions of General Condition 28 shall survive the expiration or earlier termination of this contract for any reason.

Section 29 - Surety Bonds

Bonds will be required from the successful bidder as follows:

- (1) A Performance Bond to the City of Ann Arbor for the amount of the bid(s) accepted;
- (2) A Labor and Material Bond to the City of Ann Arbor for the amount of the bid(s) accepted.

Bonds shall be executed on forms supplied by the City in a manner and by a Surety Company authorized to transact business in Michigan and satisfactory to the City Attorney.

Section 30 - Damage Claims

The Contractor shall be held responsible for all damages to property of the City or others, caused by or resulting from the negligence of the Contractor, its employees, or agents during the progress of or connected with the prosecution of the work, whether within the limits of the work or elsewhere. The Contractor must restore all property injured including sidewalks, curbing, sodding, pipes, conduit, sewers or other public or private property to not less than its original condition with new work.

Section 31 - Refusal to Obey Instructions

If the Contractor refuses to obey the instructions of the Supervising Professional, the Supervising Professional shall withdraw inspection from the work, and no payments will be made for work performed thereafter nor may work be performed thereafter until the Supervising Professional shall have again authorized the work to proceed.

Section 32 - Assignment

Neither party to the Contract shall assign the Contract without the written consent of the other. The Contractor may assign any monies due to it to a third party acceptable to the City.

Section 33 - Rights of Various Interests

Whenever work being done by the City's forces or by other contractors is contiguous to work covered by this Contract, the respective rights of the various interests involved shall be established by the Supervising Professional, to secure the completion of the various portions of the work in general harmony.

The Contractor is responsible to coordinate all aspects of the work, including coordination of, and with, utility companies and other contractors whose work impacts this project.

Section 34 - Subcontracts

The Contractor shall not award any work to any subcontractor without prior written approval of the City. The approval will not be given until the Contractor submits to the City a written statement concerning the proposed award to the subcontractor. The statement shall contain all information the City may require.

The Contractor shall be as fully responsible to the City for the acts and omissions of its subcontractors, and of persons either directly or indirectly employed by them, as it is for the acts and omissions of persons directly employed by it.

The Contractor shall cause appropriate provisions to be inserted in all subcontracts relative to the work to bind subcontractors to the Contractor by the terms of the General Conditions and all other contract documents applicable to the work of the subcontractors and to give the Contractor the same power to terminate any subcontract that the City may exercise over the Contractor under any provision of the contract documents.

Nothing contained in the contract documents shall create any contractual relation between any subcontractor and the City.

Section 35 - Supervising Professional's Status

The Supervising Professional has the right to inspect any or all work. The Supervising Professional has authority to stop the work whenever stoppage may be appropriate to insure the proper execution of the Contract. The Supervising Professional has the authority to reject all work and materials which do not conform to the Contract and to decide questions which arise in the execution of the work.

The Supervising Professional shall make all measurements and determinations of quantities. Those measurements and determinations are final and conclusive between the parties.

Section 36 - Supervising Professional's Decisions

The Supervising Professional shall, within a reasonable time after their presentation to the Supervising Professional, make decisions in writing on all claims of the City or the Contractor and on all other matters relating to the execution and progress of the work or the interpretation of the contract documents.

Section 37 - Storing Materials and Supplies

Materials and supplies may be stored at the site of the work at locations agreeable to the City unless specific exception is listed elsewhere in these documents. Ample way for foot traffic and drainage must be provided, and gutters must, at all times, be kept free from obstruction. Traffic on streets shall be interfered with as little as possible. The Contractor may not enter or occupy with agents, employees, tools, or material any private property without first obtaining written permission from its owner. A copy of the permission shall be furnished to the Supervising Professional.

Section 38 - Lands for Work

The Contractor shall provide, at its own expense and without liability to the City, any additional land and access that may be required for temporary construction facilities or for storage of materials.

Section 39 - Cleaning Up

The Contractor shall, as directed by the Supervising Professional, remove at its own expense from the City's property and from all public and private property all temporary structures, rubbish and waste materials resulting from its operations unless otherwise specifically approved, in writing, by the Supervising Professional.

Section 40 - Salvage

The Supervising Professional may designate for salvage any materials from existing structures or underground services. Materials so designated remain City property and shall be transported or stored at a location as the Supervising Professional may direct.

Section 41 - Night, Saturday or Sunday Work

No night or Sunday work (without prior written City approval) will be permitted except in the case of an emergency and then only to the extent absolutely necessary. The City may allow night work which, in the opinion of the Supervising Professional, can be satisfactorily performed at night. Night work is any work between 8:00 p.m. and 7:00 a.m. No Saturday work will be permitted unless the Contractor gives the Supervising Professional at least 48 hours but not more than 5 days notice of the Contractor's intention to work the upcoming Saturday.

Section 42 - Sales Taxes

Under State law the City is exempt from the assessment of State Sales Tax on its direct purchases. Contractors who acquire materials, equipment, supplies, etc. for incorporation in City projects are not likewise exempt. State Law shall prevail. The Bidder shall familiarize itself with the State Law and prepare its Bid accordingly. No extra payment will be allowed under this Contract for failure of the Contractor to make proper allowance in this bid for taxes it must pay.

Section 43

CONTRACTOR'S DECLARATION

I hereby declare that I have not, during the period _____, 20___, to _____, 20___, performed any work, furnished any materials, sustained any loss, damage or delay, or otherwise done anything in addition to the regular items (or executed change orders) set forth in the Contract titled _____, for which I shall ask, demand, sue for, or claim compensation or extension of time from the City, except as I hereby make claim for additional compensation or extension of time as set forth on the attached itemized statement. I further declare that I have paid all payroll obligations related to this Contract that have become due during the above period and that all invoices related to this Contract received more than 30 days prior to this declaration have been paid in full except as listed below.

There is/is not (Contractor please circle one and strike one as appropriate) an itemized statement attached regarding a request for additional compensation or extension of time.

Contractor

Date

By _____
(Signature)

Its _____
(Title of Office)

Past due invoices, if any, are listed below.

STANDARD SPECIFICATIONS

Perform all work under this contract in accordance with the Michigan Department of Transportation (MDOT) 2012 Standard Specifications for Construction. Perform all work under this Contract not included in these Standard Specifications in accordance with the City of Ann Arbor Detailed Specifications, MDOT Supplemental Specifications, and MDOT Special Provisions included in the Contract document. Any reference to the Michigan Department of Transportation (the "Department") in the above Standard Specifications, Supplemental Specifications, and Special Provisions shall also mean the City of Ann Arbor.

The Michigan Department of Transportation 2012 Standard Specification for Construction are available for download at the following web link:

<https://mdotjboss.state.mi.us/SpecProv/specBookHome.htm>

CITY OF ANN ARBOR
DETAILED SPECIFICATION
FOR
CERTIFIED PAYROLL COMPLIANCE AND REPORTING

AA:MGN/DD

1 of 2

03/10/18

a. Description. This specification covers all administrative requirements, payroll reporting procedures to be followed by Contractors performing work on City-sponsored public improvements projects, and all other miscellaneous and incidental costs associated with complying with the applicable sections of the City of Ann Arbor Code of Ordinances with regard to payment of prevailing wages and its Prevailing Wage Compliance policy.

The intent of this specification is **not** to include the actual labor costs associated with the payment of prevailing wages as required. Properly incorporate those costs in all other contract items of work bid for the project.

b. General. The Contractor will comply with all applicable sections of Federal and State prevailing wage laws, duly promulgated regulations, the City of Ann Arbor Code of Ordinances, and its Prevailing Wage Compliance Policy as defined within the contract documents. The Contractor shall provide the required certified payrolls, city-required declarations, and reports requested elsewhere in the contract documents within the timeline(s) stipulated therein.

The Contractor shall also provide corrected copies of any submitted documents found to contain errors, omissions, inconsistencies, or other defects that render the report invalid. Provide the corrected copies when requested by the Supervising Professional.

The Contractor shall also attend any required meetings as needed to fully discuss and ensure compliance with the contract requirements regarding prevailing wage compliance. The Contractor shall require all employees engaged in on-site work to participate in, provide the requested information to the extent practicable, and cooperate in the interview process. The City of Ann Arbor will provide the needed language interpreters in order to perform wage rate interviews or other field investigations as needed.

Submit certified payrolls on City-provided forms or forms used by the Contractor, as long as the Contractor forms contain all required payroll information. If the Contractor elects to provide its own forms, the Supervising Professional shall approve of their use prior to the beginning of on-site work.

c. Unbalanced Bidding. The City of Ann Arbor will examine the submitted cost for this item of work prior to contract award. If the City determines, in its sole discretion that the costs bid by the Contractor for complying with the contract requirements are not reasonable, accurately reported or contain discrepancies, the City reserves the right to request additional documentation that fully supports and justifies the price as bid. Should the submitted information not be determined to be reasonable or justify the costs, the City reserves the right to pursue award of the contract to the second low bidder without penalty or prejudice to any other remedies that it may have or may elect to exercise with respect to the original low-bidder.

The City will not extend the contract completion date as a result of its investigation of the as-bid amount for this item of work, even if the anticipated contract award date must be adjusted. The only exception will be if the Contractor adequately demonstrates that their costs were appropriate and justifiable. In such case, the City will adjust the contract completion date by the number of

calendar days commensurate with the length of its investigation if it cannot meet the published Notice to Proceed date of the work. The City will not allow adjustments to contract unit prices for all other items of work due to the adjustment of contract completion date.

d. Measurement and Payment. Measure and pay for the completed work, as described, at the contract unit price using the following pay item:

<u>Pay Item</u>	<u>Pay Unit</u>
Certified Payroll Compliance and Reporting	Lump Sum

Measure **Certified Payroll Compliance and Reporting** by the unit lump sum and pay for it at the contract unit price, which price includes costs for all supervisory, accounting, and administrative labor, and equipment and materials necessary to complete the work of monitoring, performing and maintaining compliance with the tasks required of this Detailed Specification.

Measurement will be on a pro rata basis at the time of each progress payment, and based on the ratio of work completed during the payment period and the total contract amount. When all of the work of this Contract is complete, the measurement of this item shall be 1.0 Lump Sum, less any deductions incurred for inadequate performance as described herein. This amount will not increase for any reason, including extensions of time, extras, and/or additional work.

CITY OF ANN ARBOR
DETAILED SPECIFICATION
FOR
GENERAL CONDITIONS

AA:DAD

1 of 2

03/11/19

a. Description. This item comprises all work described and required by the plans and specifications at each project location for which the contract contains no item(s) of work, including but not limited to the following:

- Scheduling, coordination, and organization of all work, subcontractors, suppliers, testing, inspection, surveying, and staking.
- Coordination of, and cooperation with, other contractors, agencies, departments, and utilities.
- Protection and maintenance of utilities.
- Maintaining drainage.
- Furnishing, placement, and grading of maintenance gravel to construct any temporary driveways, sidewalks and/or sidewalk ramps necessary for construction of the proposed work.
- Maintaining driveways drive openings, sidewalks, bike paths, mail deliveries, and solid waste/recycle pick-ups. This includes the placement and maintenance of gravel in driveway openings as directed by the Engineer.
- Storing all materials and equipment off lawn areas.
- Temporary relocation and final replacement/re-setting of mailboxes.
- Coordination efforts to furnish various HMA mixtures as directed by the Engineer
- Coordination efforts to furnish and operate various-size vehicles/equipment as directed by the Engineer
- Furnishing and operating vacuum-type street cleaning equipment a minimum of once per week or more frequently as directed by the Engineer
- Protecting all sewers, and drainage and utility structures including manholes, gate wells, valve boxes, inlet structures, roadside ditches, and culverts from damage and contamination by debris and construction materials. Keeping structures and culverts clean of construction debris and properly covered/protected at all times during the construction. Immediately cleaning any structures, sewers, culverts and/or roadside ditches contaminated with construction debris resulting from Contractor operations and/or work activities.
- Disposing of excavated materials and debris - The Contractor shall dispose of, at the Contractor's expense, all excavated material. The Engineer will not pay for any costs associated with this work separately.
- Furnishing and operating vacuum-type utility structure cleaning equipment
- Furnishing and operating both vibratory plate and pneumatic-type ("pogo-stick") compactors
- Furnishing and operating a backhoe during all work activities

- Furnishing and operating a jackhammer and air compressor during all work activities
- Noise and dust control
- Mobilization(s) and demobilization(s).
- Furnishing submittals and certifications for materials and supplies.
- All miscellaneous and incidental items such as overhead, insurance, and permit fees.
- Meeting all requirements relating to Debarment Certification, Davis Bacon Act, and Disadvantaged Business Enterprise, and providing the necessary documentation.

The Appendix of the contract documents provides data pertaining to existing soil borings to assist the Engineer and Contractor with determining the soil conditions within the construction area. The City in no way guarantees existing conditions to be the same as shown in the data. The Contractor is solely responsible for any/all conclusions it may draw from the data.

Quantities as given are approximate and are estimates for bidding purposes. The City does not guarantee their totals and they may vary by any amount. While it is the City's intent to complete the project substantially as drawn and specified herein, quantities may be changed or reduced to zero for cost savings or other reasons. **The City reserves the right to change the quantities; however, the City will not allow the Contractor to adjust unit price(s) due to such change.**

b. Materials. None Specified.

c. Construction. Not specified.

d. Measurement and Payment. Measure and pay for the completed work, as described, at the contract unit price using the following pay item:

<u>Pay Item</u>	<u>Pay Unit</u>
General Conditions, Max \$_____	Lump Sum

Measure **General Conditions, Max \$_____** by the unit lump sum and pay for it at the contract unit price, which price includes costs for all labor, equipment and materials necessary to complete the work.

The Contractor is fully responsible for all direct and/or indirect damages to property caused by unclean or damaged sewers or structures resulting from its operations and/or work activities including any/all cost associated with such damages.

Measurement will be on a pro rata basis at the time of each progress payment, and based on the ratio of work completed during the payment period and the total contract amount. When all of the work of this Contract is complete, the measurement of this item shall be 1.0 Lump Sum, less any deductions incurred for inadequate performance as described herein. This amount will not increase for any reason, including extensions of time, extras, and/or additional work.

CITY OF ANN ARBOR
DETAILED SPECIFICATION
FOR
PROJECT SUPERVISION

AA:DAD

1 of 4

03/04/20

a. Description. The Contractor shall provide supervision in accordance with the City of Ann Arbor Standard Specifications, subsections 104.07 and 107.15 of the Michigan Department of Transportation (MDOT) 2012 Standard Specifications for Construction, and as described herein.

The Contractor shall designate a full-time Project Supervisor to act as the Contractor's agent/representative, and to be responsible for scheduling and coordination of all subcontractors, suppliers, other governmental agencies, and all public and private utility companies.

The Project Supervisor shall not be an active crewmember of the Contractor, shall not be an active member or employee of any subcontractor's work force, and shall not perform general or specialized labor tasks. The Project Supervisor shall be a full-time employee of the General Contractor and shall have all needed authority to make binding decisions on behalf of the Contractor in all matters pertaining to performance and execution of the work of the project.

The Project Supervisor shall work exclusively on this project and shall put forth his/her full effort into the organization and coordination of the work of this project.

One week prior to the pre-construction meeting, the Contractor shall designate a proposed Project Supervisor by name, and shall furnish the Engineer with a current, thorough, detailed summary of the proposed Project Supervisor's work history, outlining all previous supervisory experience on projects of a similar size and nature. The detailed work history shall include personal and professional references (names and phone numbers) of persons (previous owners or agents) who can attest to the qualifications and work history of the proposed Project Supervisor. Proposed candidates for Project Supervisor shall have a demonstrated ability to work harmoniously with the Engineer, the City, the public, subcontractors, and all other parties typically involved with work of this nature. The Engineer will have the authority to reject a proposed Project Supervisor whom he/she considers unqualified.

The Project Supervisor shall be available 24 hours-per-day to provide proper supervision, coordination and scheduling of the project for the duration of the Contract. The Contractor shall furnish the City with telephone numbers of the Project Supervisor in order to provide 24 hour-per-day access during business and non-business hours, including weekends and holidays.

The Project Supervisor shall be equipped by the Contractor with a "smart" mobile telephone with "data" and "text" capabilities to provide the City with 24 hour-per-day access to him/her during daily construction activities, during transit to and from the construction site, and during all non-business hours including weekends and holidays.

The Project Supervisor shall be equipped with assistants as necessary to provide project supervision as specified herein, and in accordance with the Contract.

1. Duties and Responsibilities. The Project Supervisor shall work harmoniously with the Engineer, the City, the public, subcontractors, and all other parties typically involved with work of this nature.

The Project Supervisor shall have a thorough, detailed understanding and working knowledge of all construction practices and methods specified elsewhere herein, as well as the handling, placement, testing and inspection of aggregates, aggregate products, bituminous concrete, Portland cement concrete materials, and other such materials and products related to the work of this project.

The Project Supervisor shall be responsible for all of the work of all of the Contractor, subcontractor and/or supplier work forces.

The Project Supervisor shall be responsible for proper and adequate maintenance (emissions, safety, and general operation) of all of the Contractor's, subcontractors' and suppliers' equipment and vehicles. The Project Supervisor shall make all needed diligent and good faith efforts to ensure that all equipment utilized in the performance of the work is properly maintained, safe, and complies with all legal and environmental requirements of the work as set forth in section 107.15 of the MDOT 2012 Standard Specifications for Construction.

The Project Supervisor shall be responsible for the legal, proper and safe parking/storage of all of the Contractor, subcontractor and/or supplier equipment, work vehicles, and employee's vehicles.

The Project Supervisor shall schedule and coordinate the work of all parties involved in the project, including utility companies, testing agencies, governmental agencies, all City departments (such as Utilities and Transportation), and City inspectors.

The Project Supervisor shall coordinate and schedule the work of any independent survey crews retained by the Engineer or City to witness and reset existing and new geographic/benchmark monuments. Failure to have existing monuments witnessed and reset may result in delays to the Contractor's work. Costs for such delays will be the Contractor's sole responsibility. The Project Supervisor shall also schedule and complete all needed survey request forms required to schedule the services of survey personnel to properly layout all elements of the project work in accordance with the City of Ann Arbor Public Services Area Standard Specifications and the MDOT 2012 Standard Specifications for Construction.

The Project Supervisor shall coordinate, and schedule inspection performed by the City and Consultants (including material testing firms) in a timely manner, to assure proper and timely testing and inspection of the work.

The Project Supervisor shall submit to the Engineer, an updated, detailed schedule of the proposed work on a weekly basis, and an update of all proposed changes on a daily basis.

The Project Supervisor and all subcontractors shall attend a weekly progress meeting chaired by the Engineer to discuss the work. Upon the completion of each meeting, the Engineer shall prepare and distribute, to all present, a written summary of the meeting's

minutes. Those in attendance shall review the minutes and, if necessary, comment on any deficiencies or errors prior to or at the next scheduled progress meeting.

2. **Additional Performance Requirements.** If, in the sole opinion of the Engineer, the Project Supervisor is not adequately performing the duties as outlined in this detailed specification, the following system of notices will be given to the contractor with the associated penalties:

First Notice – The Engineer will issue a warning in writing to the Contractor detailing the deficiencies in the Project Supervision. The Contractor must respond within seven (7) calendar days in writing with a plan to correct the stated deficiencies. Failure to respond within seven (7) calendar days will result in the issuing of a second notice.

Second Notice – The Engineer will issue a second warning in writing to the Contractor further detailing the deficiencies in the Project Supervision. The Engineer will deduct 10%, or \$10,000, whichever is greater, from the original contract amount bid for the Project Supervision contract item of work. The Contractor must respond within seven (7) calendar days in writing with a plan to correct the stated deficiencies. Failure to respond within seven (7) calendar days will result in the issuing of a third notice. At this time, the Engineer reserves the right to meet with personnel with the necessary authority within the Contractor's organization to discuss the deficiencies in the Project Supervision.

Third Notice – The Engineer will issue a third notice in writing to the Contractor further detailing the deficiencies in the Project Supervision. The Engineer will deduct 25%, or \$25,000, whichever is greater, from the original contract amount bid for the Project Supervision contract item of work, and the Contractor will remove and replace the Project Supervisor immediately with another individual approved by the Engineer.

Should, in the sole opinion of the Engineer, the Project Supervisor fail to perform his/her duties and responsibilities as described herein to such a degree that the successful completion of the project is put in jeopardy, the above system of notices may be foregone, and the Contractor shall immediately replace the Project Supervisor upon receipt of written notice. The Engineer, in its determination, will consider failure by the Contractor to provide adequate project supervision as a basis to suspend work without the extension of contract time or additional compensation.

If the original Project Supervision contract amount is insufficient to cover said deductions, the Engineer will reduce Project Supervision contract amount to zero and will generate a contract modification to assess a penalty to cover the difference between the Project Supervision contract amount and the total amount of the deduction(s). The expectation is that the Project Supervision contract amount will be sufficient to cover any deductions.

b. Materials. None Specified.

c. Construction. Not specified.

d. Measurement and Payment. Measure and pay for the completed work, as described, at the contract unit price using the following pay item:

Pay Item

Pay Unit

Project Supervision, Max \$___Lump Sum

Measure **Project Supervision, Max \$___** by the unit lump sum and pay for it at the contract unit price, which price includes costs for all labor, equipment and materials necessary to complete the work.

Measurement will be on a pro rata basis at the time of each progress payment and based on the ratio of work completed during the payment period and the total contract amount. When all of the work of this Contract is complete, the measurement of this item shall be 1.0 Lump Sum, less any deductions incurred for inadequate performance as described herein. This amount will not increase for any reason, including extensions of time, extras, and/or additional work.

CITY OF ANN ARBOR
DETAILED SPECIFICATION
FOR
MATERIAL AND SUPPLY SUBMITTALS AND CERTIFICATIONS

AA:DAD

1 of 1

02/27/19

a. Description. This work includes submittal to the Engineer by the Contractor and its Subcontractors and prior to commencement of work; Michigan Department of Transportation Form 0501 (attached) showing all materials and supplies proposed for use on the project, and any product data information requested by the Engineer. It also includes furnishing certifications to the Engineer for review and approval a minimum of three business days prior to any scheduled delivery, installation, and/or construction of the same. The manufacturer or supplier shall certify the following materials and supplies are compliant with the contract specifications unless otherwise directed by the Engineer:

- Cement and lime
- Aggregates
- Admixtures and curing materials for concrete
- Asphaltic materials
- Steel reinforcement
- Structural steel
- Fencing materials
- Miscellaneous metal products
- Drainage products
- Geosynthetics
- Timber and lumber
- Masonry units
- Joint and waterproofing materials
- Bridge coating systems
- Erosion and sedimentation control materials
- Turf and landscaping materials
- Electrical and lighting materials
- Permanent traffic sign and support materials
- Permanent paving marking materials
- Permanent traffic signal materials
- Temporary traffic control materials
- Sanitary sewer materials
- Water main materials

b. Materials. None specified.

c. Construction. Not specified.

d. Measurement and Payment. Costs for this work will not be paid for separately, but shall be included in the Contract pay Item "General Conditions, Max \$____".

CITY OF ANN ARBOR
DETAILED SPECIFICATION
FOR
VACUUM TYPE CLEANING EQUIPMENT

AA:DAD

1 of 1

02/25/18

a. Description. This work includes furnishing and operating throughout the construction period, vacuum type street cleaning and utility structure cleaning equipment (Vac-All, Vactor, etc.) approved by the Engineer, as and when directed by the Engineer for dust control, for dirt/debris control, and for street cleaning immediately prior to paving, and for street and utility structure cleaning after any and all paving.

b. Materials. None specified.

c. Construction. The Contractor shall furnish and operate throughout the construction period, vacuum type street cleaning and utility structure cleaning equipment (Vac-All, Vactor, etc.) approved by the Engineer. When directed by the Engineer, the Contractor shall use this equipment to control dust, dirt, and other debris within the project limits and beyond as required, to clean streets surfaces immediately prior to placing HMA pavement mixtures, and for street and utility structure cleaning after any and all paving. The cleaning equipment shall be of sufficient power to remove dust, dirt, and debris from the pavement and from utility structures in and adjacent to the construction area.

d. Measurement and Payment. The Engineer will not pay for the work required of this detailed specification separately. The Contractor shall include it in the contract unit price bid for the pay item **General Conditions, Maximum, \$___**.

CITY OF ANN ARBOR
DETAILED SPECIFICATION
FOR
PROJECT SCHEDULE

AA:DAD

1 of 3

02/19/21

Complete the entirety of work under this Contract in accordance with, and subject to, the scheduling requirements as outlined below, and all other requirements of the Contract Documents.

Organize, coordinate and diligently execute the work at the locations shown on the Schedule of Streets included herein. This schedule details the requirements, if any, for the Start of Work (on or after dates specified), the Completion of Work (on or before dates specified), Restricted Dates, the Maximum Calendar Days for Open to Traffic, and the Liquidated Damages per Calendar Day for each street or phase of work. For the purpose of this Contract, the "Start of Work" definition is the date when the temporary "No-Parking" signs become effective and all required temporary traffic control and SESC measures are in place and ready for use. The City will consider individual major street locations and local street phases to be open to traffic once they have met the "Approved for Traffic" requirements defined in subsection 107.21 of the Michigan Department of Transportation 2012 Standard Specifications for Construction. Within 10 days of opening to traffic an individual major street location or local street phase the Contractor shall complete all work, which includes, but is not limited to, placement of permanent pavement markings, minor slope restoration, clean-up, street cleaning, underground utility and utility structure cleaning (minor street phases), the removal of all temporary traffic control and SESC devices and temporary "No Parking" signs, and other necessary work and as directed by the Engineer. Failure to complete work in a timely manner may result in the suspension of active project work or a delay in starting subsequently planned project work.

The Engineer shall limit the Contractor's work operations to the number of streets that, in its opinion, is reasonable to allow for proper and thorough inspection, and to limit traffic control and/or safety concerns. The Contractor shall not have more than one (1) major street or shared use path locations and one (1) local phase "active" simultaneously at any given time throughout the project unless otherwise noted in the Schedule of Streets or approved by the Engineer. A location is "active" if work has begun and it has not yet been completed.

Conduct the local street phased work as shown on the Schedule of Streets beginning with one phase and opening it to traffic before progressing to the next and continue in this manner until all phases are complete. Begin work on Phase 1 and continue in order through Phase 4 unless otherwise directed or approved by the Engineer. The Engineer will allow preparation of subsequent project phase work up to five (5) days in advance of the planned open to traffic date for the phase on which the Contractor is currently working. This work includes placement/installation of temporary "No-Parking" signs and temporary traffic control and SESC devices. In no case will work be allowed to progress on a subsequent project phase beyond that considered preparational until the current phase is open to traffic or the Engineer directs otherwise. During this five (5) day period the Contractor will cover all temporary "No-Parking" and temporary traffic control signs by methods approved by the Engineer until such time they become effective and are needed for use.

The City expects to furnish the Contractor with two (2) copies of the Contract, for its execution, on or before **March 26, 2021**. The Contractor shall properly execute both copies of the Contract and return them, with the required Bonds and Insurance documentation, to the City by **April 26,**

2021. The Contractor shall not begin the work before the applicable date(s) as described herein without approval from the Project Engineer, and in no case before the receipt of the fully executed Contract and Notice to Proceed.

By no later than **April 30, 2021**, the Contractor shall submit a detailed schedule of work (progress schedule) for the Engineer's review and approval. The progress schedule must fully comply with the scheduling requirements contained on the Schedule of Streets. The schedule shall clearly indicate, in detail, the start and the finish date of each work task on each street. The Contractor shall update the approved progress schedule each week and present it to the Engineer at the weekly progress meeting and must consult with the Engineer for review and approval of any proposed deviations from the most current, approved, schedule.

The Contractor shall begin the work of this project on or after **May 3, 2021**, and only upon receipt of the fully executed Contract, Notice to Proceed and approved Progress Schedule. The City will consider granting appropriate time extensions should delays prevent the Contractor from starting work on this date.

Complete the entire project on or before **October 30, 2021**. Completion of the project means all locations shown on the Schedule of Streets are complete and ready for use in accordance with the "Completion of Work" as defined above.

Failure to open to traffic or complete all work as specified within the times specified, including time extensions granted thereto as determined by the Engineer, shall entitle the City to deduct dollar amounts specified in the Schedule of Streets as "Liquidated Damages" from the payments due the Contractor. The City will assess "Liquidated Damages" for delays in the opening to traffic and/or the completion of work for each street or phase, for each calendar day the street or phase remains unopen and/or the work remains incomplete beyond the required contract completion date or timeframe.

Time is of the essence in the performance of the work of this contract. The Contractor is expected to mobilize sufficient personnel and equipment and work throughout all authorized hours to complete the project by the intermediate (location specific) and final completion dates. Should the Contractor demonstrate that they must work on some Sundays in order to maintain the project schedule, they may do so between the hours of 9:00 a.m. and 5:00 p.m. with prior approval from the City. There will be no additional compensation due to the Contractor for work performed on Sundays.

The Engineer may delay or stop the work due to threatening weather conditions. No compensation shall be due the Contractor for unused materials or downtime due to rain, or the threat of rain. The Contractor is solely responsible for repairing all damages to the work and to the site, including any City infrastructure, and any adjacent properties resulting from its decision to work in the rain.

The Contractor shall not work in the dark except as approved by the Engineer and shall provide lighting for night work as detailed elsewhere in this contract. The Engineer may stop the work or may require the Contractor to defer certain work to another day, if, in the Engineer's opinion, the Contractor cannot be complete the work within the remaining daylight hours, or if inadequate daylight is present to properly perform or inspect the work. No compensation shall be due to the Contractor for unused materials or downtime, when the Engineer directs work stoppage for reasons due to darkness and/or inadequate remaining daylight. The Contractor is solely

responsible for repairing all damages to the work and to the site, including any City infrastructure, and any adjacent properties, which result from working in the dark.

Assessment of Liquidated Damages will occur until the required work is complete in the current construction season. If, with the Engineer's approval, work extends beyond seasonal limitations, the assessment of Liquidated Damages will discontinue until the work resumes in the following construction season.

If the construction contract is not complete within the specified period(s) including any extensions of time granted thereto, at the sole discretion of the City of Ann Arbor it may terminate the Contract. Should this occur no additional compensation will be due to the Contractor, and the Contractor may be forbidden to bid on future City of Ann Arbor projects for a period of at least three (3) years. If the Engineer elects to terminate the Contract, payment for contract items with a Lump Sum unit price will be up to a maximum amount equal to the percentage of the contract work that is complete at the time of termination.

The City's decision to delete streets or phases, add streets, change the construction limits on streets, or, the City's contribution to a delay of the construction on any one street shall not entitle the Contractor to receive additional compensation for work on any other street(s) or phase(s), nor shall it relieve the Contractor of any responsibilities for completion of work on any other street(s) or phase(s).

Include any/all efforts to organize, coordinate, and schedule the project work in the contract unit price bid for the pay item **General Conditions, Max \$_____**.

Street Resurfacing Project – 2021

Schedule of Streets

Location (Street)	Limits of Work	Start of Work	Open to Traffic or *Completion of Work	Date Restrictions and Project Coordination	**Maximum Calendar Days	Liquidated Damages per Calendar Day
MAJOR STREETS						
Packard Street Shared Use Path	Independence Blvd to Platt Rd			AAATA, INDP, MMRL, UMFB	30	\$500
Huron Parkway approach to Lindsay Lane	Deceleration/right turn lane approach to Lindsay Ln			AAATA, MMRL	14	\$500
MINOR (LOCAL) STREETS						
Traffic Calming						
Glenwood Road	Washtenaw Ave to Override Dr	07/01/2021		INDP, LABR	21	\$500
Phase 1						
Baldwin Avenue	Packard St to E Stadium Blvd					
Brockman Boulevard	Packard St to E Stadium Blvd					
Carhart Avenue	Crestland St to Winchell Dr					
Crestland Street	Packard St to Amelia Pl/ Saint Francis Dr			AAPS1, MMRL	35	\$750
Eastover Place	Jewett St/Packard St to Ferdon Rd					
Ferdon Road	Eastover Pl to South Blvd					
Saint Francis Drive	Amelia Pl/Crestland St to Nature Cove Ct					
Phase 2A						
Canterbury Road	Towner Blvd/Dorchester Rd to Platt Rd					
Dorchester Road	Manchester Rd to Towner Blvd/Canterbury Rd					
Independence Boulevard 2	Manchester Rd to Nottingham Rd			AAPS1, AAPS2, INDP	35	\$750
Manchester Road	End of Cul-de-sac to Scio Church Rd					
Towner Boulevard	Dorchester Rd/Canterbury Rd to Hampshire Rd					

Street Resurfacing Project – 2021

Schedule of Streets

Location (Street)	Limits of Work	Start of Work	Open to Traffic or *Completion of Work	Date Restrictions and Project Coordination	**Maximum Calendar Days	Liquidated Damages per Calendar Day
MINOR (LOCAL) STREETS - CONTINUED						
Phase 2B						
Chesterfield Street	Packard St to Cranbrook					
Cranbrook Road	Chesterfield St/Hampshire Rd to Towner Blvd					
Gladstone Avenue	Packard St to Candlewick Dr			LABR	35	\$750
Independence Boulevard 1	Packard St to Manchester Rd					
Victoria Avenue	Ridge Ave to Camelot Rd					
Yorkshire Road	Dorchester Rd to Nottingham Rd					
Phase 3						
Brandywine Street	Packard St to Yost Blvd					
Eddy Street	Verle Ave to Southerly End					
Marshall Street	Verle Ave to Verle Ave					
Saint Aubin Avenue	La Salle St to Creek Dr				35	\$750
Verle Avenue	Westerly End to Platt Rd					
Yost Boulevard	Terhune Rd to Darrow Dr/Parkwood Ave					

*Complete all work required for this project location by the date shown.

**Maximum calendar days allowed to open project location or phase to traffic, or to complete all required work if so designated in the above table.

Date Restrictions and Project Coordination

AAATA - Coordinate work and maintenance of traffic with that of the Ann Arbor Area Transportation Authority for bus route service.

AAPS1 - No work permitted when Ann Arbor Public Schools are in session (before June 14, 2021 or after August 28, 2021).

AAPS2 - Coordinate work and maintenance of traffic with City of Ann Arbor Public Schools Allen Elementary School site work.

INDP - No work during the Independence Day holiday period from 3:00 p.m. July 2 to 7:00 a.m. July 6, 2021.

MMRL - No work during the Memorial Day holiday period from 3:00 p.m. May 28 to 7:00 a.m. June 1, 2021.

LABR - No work during the Labor Day holiday period from 3:00 p.m. September 3 to 7:00 a.m. September 7, 2021.

Street Resurfacing Project – 2021

Schedule of Streets

Date Restrictions and Project Coordination (continued)

UMFB - No work permitted during scheduled home game dates (TBD) for University of Michigan Football.

Notes

1. Date Restrictions shown above are based on a preliminary project construction schedule developed by the City for planning purposes. These may change for project locations with no specific required start and/or open to traffic or completion of work dates.
2. Work operations on the Huron Parkway and Glenwood Avenue locations are not included in the limitations specified in the Project Schedule and may occur in conjunction with one (1) major street or shared use path location and one (1) local phase; however, the Contractor will not be permitted to work on any of these locations simultaneously unless approved by the Engineer.

CITY OF ANN ARBOR
DETAILED SPECIFICATION
FOR
MAXIMUM UNIT WEIGHT

AA:DAD

1 of 1

03/10/18

Determination of the maximum dry density per cubic foot (lbs/ft³) will be using test method AASHTO T-180 unless otherwise directed by the Engineer. Use the determined value(s) as the maximum unit weight when measuring the in place compaction or density of soils unless such value(s) are determined by an alternate test method as directed by the Engineer.

CITY OF ANN ARBOR
DETAILED SPECIFICATION
FOR
REMOVING CONCRETE ITEMS

AA:DAD

1 of 2

03/11/19

a. Description. This work consists of removing concrete items including curb, gutter, curb and gutter, integral curb, sidewalk, sidewalk ramps, driveway openings, and driveway approach pavements as shown on the plans, in accordance with section 204 of the Michigan Department of Transportation (MDOT) 2012 Standard Specifications for Construction, except as specified herein, and as directed by the Engineer.

b. Materials. Provide materials in accordance with those specified in section 204 of the MDOT Standard Specifications for Construction.

c. Construction. Complete this work, as applicable, according to in section 204 of the MDOT 2012 Standard Specifications for Construction, as described below, and as directed by the Engineer.

Replace concrete curb, gutter, curb and gutter, sidewalk, sidewalk ramps, drive openings, and driveway approaches within 24 hours of their removal.

Prior to the start of work, the Engineer and Contractor together will identify and field measure all concrete removal items. The Engineer will approve of all removal limits prior to the Contractor performing any concrete removal work.

Perform full-depth saw cutting at removal limits, including those necessary to construct 2-foot wide "Det M" driveway openings, and including those necessary to provide for the partial removal of existing drive approaches as shown on the plans, as directed by the Engineer, and as marked for removal. The Contractor shall cut steel reinforcement bars as directed by the Engineer at all areas of removal. Perform any/all saw cutting under wet conditions to prevent excessive airborne dust. Clean up any/all resulting slurry and debris to the satisfaction of the Engineer immediately after performing saw cutting work.

The work includes excavation of any/all concrete designated for removal; stump and brush removal, as required; disposal of removed materials; and backfilling and compaction, as required.

The Contractor will coordinate with the City Forester prior to the removal of any tree roots.

At various times throughout the work, the Engineer may direct the Contractor to use smaller and/or lighter equipment, and to defer certain work tasks, in order to protect the grade and/or adjacent areas. The Contractor shall not be entitled to any additional compensation for the use of smaller equipment, lighter equipment, or work task deferral.

Use blade graders, maintainers, vibratory rollers, and/or other equipment as necessary, and as directed by the Engineer. The use of each specific piece of equipment is subject to the approval of the Engineer.

Where replacing existing concrete curb or curb and gutter on a street with a concrete (or brick) base, the Engineer may direct the Contractor to remove a one (1) foot wide, full-depth section of pavement and pavement base immediately in front of the curb and gutter. As part of this pavement/base removal, the Contractor will perform additional (double) full-depth saw-cutting along the entire removal limits, and take sufficient care so as not to damage and/or disturb any adjacent pavement, pavement base, and/or any other site feature, all as directed by the Engineer. The removals will be to a sufficient width and depth to allow for the placement and removal of the curb and gutter formwork. After the removal of the formwork, the Contractor will replace the concrete base to its original thickness and elevation(s).

Excavated/removal areas shall be adequately protected with barricades and/or fencing at all times.

Removed or excavated materials not incorporated into the work will become the property of the Contractor and be immediately removed and properly disposed of off-site. DO NOT stockpile overnight on site, or adjacent to it, any removed or excavated materials.

Replace and compact any/all base, subbase, or subgrade materials removed without authorization with materials specified by the Engineer. The Contractor will perform this work at its expense.

d. Measurement and Payment. Measure and pay for the completed work, as described, at the respective contract unit prices using the following respective pay items:

<u>Pay Item</u>	<u>Pay Unit</u>
Curb, Gutter, and Curb and Gutter, Any Type, Rem	Foot
Sidewalk, Sidewalk Ramp, and Driveway Approach, Any Thickness, Rem	Square Yard

Measure **Curb, Gutter, and Curb and Gutter, Any Type, Rem** lengths in place by the unit foot and pay for it at the contract unit price, which price includes the costs for all labor, equipment and materials necessary to complete the work.

Measure **Sidewalk, Sidewalk Ramp, and Driveway Approach, Any Thickness, Rem** areas in place by the square yard and pay for it at the contract unit price, which price includes the costs for all labor, equipment and materials to complete the work.

Saw cutting is not a separate contract pay item. Include payment for this work in the appropriate item of work for which it applies. The Contractor shall include any/all costs for saw cutting to remove concrete items including curb, gutter, curb and gutter, integral curb, sidewalk, sidewalk ramps, driveway openings, and driveway approach pavements in the respective contract unit prices bid for **Curb, Gutter, and Curb and Gutter, Any Type, Rem** and **Sidewalk, Sidewalk Ramp, and Driveway Approach, Any Thickness, Rem**.

CITY OF ANN ARBOR
DETAILED SPECIFICATION
FOR
VERTICAL EXPLORATORY EXCAVATION

AA:DAD

1 of 2

03/10/18

a. Description. The use of this detailed specification is to compensate the Contractor to locate underground infrastructure, such as culverts, sewers, utilities, and/or to expose the existing pavement section. Use must only be as directed and approved by the Engineer. This detailed specification is not to compensate the Contractor for the responsibilities in subsection 107.12 of the Standard Specifications for Construction.

This work consists of conducting a vertical exploratory investigation to expose an existing culvert, sewer, utility/utility service, or the existing pavement section in order to verify the location, condition, size, material, alignment and/or composition; allowing the Engineer to document the necessary information; and backfilling the excavation. It includes providing necessary lane, shoulder and/or sidewalk closures required to perform the work.

The intent of "Exploratory Excavation" is not to provide a means for the Contractor to locate each existing utility throughout the project, but for those that appear to be in conflict with the proposed work and their location is unclear or unknown. The Contractor is responsible for "using reasonable care to establish the precise location of the underground facilities in advance of construction" (Public Act 174 of 2013 - Miss Dig Law) as a part of the overall project contract.

b. Materials. Use Granular Material Class III in accordance with section 902 of the Standard Specifications for Construction for backfill. Use material removed during exploratory investigation for backfill only if approved by of the Engineer.

c. Construction. The owner of any sewer or utility to be exposed will not take the facilities out of service during the exploratory investigation. Contact utility owners in accordance with subsection 107.12 of the Standard Specifications for Construction.

Establish necessary lane, shoulder and/or sidewalk closures required to perform work.

Advance the exploratory excavation using vacuum excavation, hand digging, conventional machine excavation, or a combination thereof subject to approval of the Engineer. Allow the Engineer access to document the necessary information. If the technique used to advance the excavation causes any damage to the existing facilities, immediately contact the utility owner and cease all work until Engineer approves of an alternate method.

Take care to protect the exposed culvert, sewer or utility from damage during construction. Repair or replace culvert, sewer or utility, damaged during exploratory excavation, in accordance with the standard specifications and as approved by the Engineer.

Obtain the Engineer's approval before backfilling the excavation. Complete backfilling no later than 24 hours after approval. Backfill in accordance with subsection 204.03.C of the Standard Specifications for Construction. Dispose of excess material in accordance with the standard specifications.

The Contractor is responsible for all costs associated with the repair work and out of service time of all broken or damaged existing culverts, sewers or utilities resulting from any action by the Contractor. If the exploratory investigation results in damage to utilities, contact the owner of such utility to coordinate the repair.

d. Measurement and Payment. Measure and pay for the completed work, as described, at the contract unit price for the following pay item:

<u>Pay Item</u>	<u>Pay Unit</u>
Exploratory Excavation, Vertical	Foot

Measure **Exploratory Investigation, Vertical** by the foot from top of existing grade vertically to the bottom of the excavation for a 4-foot maximum diameter hole, or as approved by the Engineer. Measure and pay for the excavated depth of each 4-foot maximum diameter hole separately. One paid excavation may be include multiple utility verifications if the utilities are close in proximity.

Exploratory Investigation, Vertical includes all cost for labor, equipment and materials necessary to complete the work, including all costs associated with repair or replacement resulting from the Contractor's activities.

CITY OF ANN ARBOR

DETAILED SPECIFICATION
FOR
GRADING SIDEWALKS, SIDEWALK RAMPS, AND DRIVEWAYS

AA:DAD

1 of 1

03/11/19

a. Description. Remove miscellaneous structures and materials, and complete all earthwork required to construct new and replacement sidewalks, sidewalk ramps, driveways, and driveway approaches to the lines and grades shown on the plans and/or as directed by the Engineer. Complete this work according to the Michigan Department of Transportation (MDOT) 2012 Standard Specifications for Construction, this detailed specification, and as directed by the Engineer.

b. Materials. Provide materials in accordance with subsection 205.02 of the MDOT 2012 Standard Specifications for Construction as necessary to achieve the required cross section(s). The Contractor may use excavated material, if suitable, as embankment with approval by the Engineer.

c. Construction. Complete this work, as applicable, according to subsection 205.03 of the MDOT 2012 Standard Specifications for Construction. Grading for sidewalks and sidewalk ramps includes, but is not limited to, the following work:

1. Stripping and stockpiling topsoil for use in turf establishment as approved.
2. Removing rocks or boulders less than 0.5 cubic yards in volume.
3. Excavating material to a depth necessary for construction.
4. Disposing of excess and unsuitable material according to section 205 of the MDOT 2012 Standards Specifications for Construction.
5. Furnishing and placing embankment material to the grades necessary for construction.
6. Shaping, grading, and compacting the subgrade and embankment to proposed grades to prepare it for subbase or aggregate base bedding materials or for an aggregate surface course.
7. Matching new sidewalk, sidewalk ramp, and driveway approach grades with existing grades as required.

d. Measurement and Payment. Measure and pay for the completed work, as described, at the contract unit price using the following pay items:

<u>Pay Item</u>	<u>Pay Unit</u>
Grading, Driveway Approach	Square Yard
Grading, Sidewalk	Square Yard
Grading, Sidewalk Ramp	Square Yard

Measure **Grading, Driveway Approach; Grading, Sidewalk; and Grading, Sidewalk Ramp** areas in place by the unit square yard and pay for them at their respective contract unit prices, which prices include the costs for all labor, equipment and materials necessary to complete the work.

CITY OF ANN ARBOR

DETAILED SPECIFICATION
FOR
GRADING SIDEWALKS, SIDEWALK RAMPS, AND DRIVEWAYS

AA:DAD

1 of 2

03/23/20

a. Description. Remove miscellaneous structures and materials, and complete all earthwork required to construct new and replacement sidewalks, sidewalk ramps and driveway approaches to the lines and grades shown on the plans and/or as directed by the Engineer. Complete this work according to the Michigan Department of Transportation (MDOT) 2012 Standard Specifications for Construction, this detailed specification, and as directed by the Engineer.

b. Materials. Provide materials in accordance with subsection 205.02 of the MDOT 2012 Standard Specifications for Construction as necessary to achieve the required cross section(s). The Contractor may use excavated material, if suitable, as embankment with approval by the Engineer.

c. Construction. Complete this work, as applicable, according to subsection 205.03 of the MDOT 2012 Standard Specifications for Construction. Grading for sidewalks, sidewalk ramps and driveway approaches includes, but is not limited to, the following work:

1. Stripping and stockpiling topsoil for use in turf establishment as approved.
2. Removing rocks or boulders less than 0.5 cubic yards in volume.
3. Excavating material to a depth necessary for construction.
4. Disposing of excess and unsuitable material according to section 205 of the MDOT 2012 Standards Specifications for Construction.
5. Shaping, grading, and compacting the subgrade to proposed grades to prepare it for embankment, subbase or aggregate base bedding materials or for an aggregate surface course.
6. Furnishing and placing embankment material to the grades necessary for construction.
7. Shaping, grading, and compacting embankment to proposed grades to prepare it for subbase or aggregate base bedding materials or for an aggregate surface course.
8. Matching new sidewalk, sidewalk ramp, and driveway approach grades with existing grades as required.

d. Measurement and Payment. Measure and pay for the completed work, as described, at the contract unit price using the following pay items:

<u>Pay Item</u>	<u>Pay Unit</u>
Grading, Driveway Approach	Square Yard
Grading, Sidewalk	Square Yard
Grading, Sidewalk Ramp	Square Yard

Measure **Grading, Driveway Approach; Grading, Sidewalk;** and **Grading, Sidewalk Ramp** areas in place by the unit square yard and pay for them at their respective contract unit prices, which prices include the costs for all labor, equipment and materials necessary to complete the work.

CITY OF ANN ARBOR
DETAILED SPECIFICATION
FOR
MACHINE GRADING

AA:DAD

1 of 5

03/11/19

a. Description. This work consists of constructing earth grades by excavating, cutting, filling, trimming, and grading, and maintaining the work in a finished condition until such time of acceptance by the Engineer. Complete machine grading in accordance with section 205 of the Michigan Department of Transportation (MDOT) 2012 Standard Specifications for Construction as shown on the plans, and as specified herein with the exception that subgrade undercutting, which if included in the Contract the Engineer will pay for separately. Machine grading includes all the work described herein, and as directed by Engineer.

b. Materials. Use materials meeting the requirements specified in subsection 205.02 of the MDOT 2012 Standard Specifications for Construction.

c. Construction. Use construction methods meeting the requirements specified in subsection 205.03 of the MDOT 2012 Standard Specifications for Construction, except as specified herein.

1. Soils Information - Soil information provided as part of the contract documents is for informational purposes only and shall not relieve the Contractor of the responsibility of investigating all local conditions before bidding.
2. General Provisions:
 - A. Grade around mailboxes, trees, light poles, power poles, and the like, which are to remain in place. The Contractor is responsible for any damage caused to such structures.
 - B. Maintain the work in a finished condition until acceptance by the Engineer.
3. Pavement Sawcutting - The work includes the full-depth saw cutting of pavement at the construction limits, and elsewhere as required.
4. Clearing, and Removal of Trees and Vegetation - Remove and properly dispose of off-site all vegetation; brush; roots; and trees and stumps less than 6 inch in diameter, as shown on the plans, and as directed by the Engineer and as required to complete the project.
5. Removal and Salvaging of Topsoil – Perform the removal, salvaging and stockpiling of topsoil, and all related work in accordance with subsection 205.03.A.1 of the MDOT 2012 Standard Specifications for Construction.
6. Miscellaneous Removals - The removal of HMA, aggregate, and/or concrete materials from around manholes, structures, and utility covers, and the removal of HMA curbing, HMA driveway wedges, HMA surface on existing curb and gutter, and HMA surfaces required for removal in other miscellaneous areas. It also includes the removal of any surface feature located within the grading limits requiring removal and for which there is no specific pay item established in the Contract.
7. Protection of the Grade – Keep work well drained at all times. Undercut and backfill any

foundation, pathway or roadway embankment or subgrade damaged by rain, as directed by the Engineer.

The Contractor is responsible for maintaining the foundation, pathway or roadway embankment, and subgrade.

Do not use rubber-tired equipment on the foundation, pathway or roadway embankment, or subgrade, when its use causes, in the opinion of the Engineer, unnecessary damage to the foundation, road embankment or subgrade. Conduct operations and provide the necessary equipment to ensure the satisfactory completion of the work without damaging the foundation, pathway or roadway embankment or subgrade. This may require the transporting and movement of materials over additional distances.

At various times throughout the work, the Engineer may direct the Contractor to use smaller and/or lighter equipment, and to defer certain work tasks, in order to protect the grade and/or adjacent areas. The Engineer will not grant an extension of time or any additional compensation for the use of smaller equipment, lighter equipment, or work task deferral.

8. Removal of Cable, Conduits and Pipe - Remove, and properly dispose of off-site, all abandoned cables, conduit, and pipe encountered at, or above the bottom of any earthwork excavation or undercut. Where the inverts of existing conduits or pipe are less than 16 inches below the bottom of any earth excavation or undercutting, remove the conduits and/or pipe and fill void with an Engineer approved material. Compact fill material to 95% of its maximum unit weight in lifts not exceeding 12 inches.

9. Foundation Preparation – The pathway or roadway “foundation” definition is the original or established earth subgrade of the pathway or roadway upon which the Contractor will place embankment material. Complete foundation work in accordance with subsection 205.03.A of the MDOT 2012 Standard Specifications for Construction as shown on the plans, and as specified herein.

Compact foundation to 95% of its maximum unit weight, as measured by the AASHTO T-180 method, to a depth of at least 10 inches. If this is not achievable, in the opinion of the Engineer, perform “**Subgrade Undercutting, Type __**” or “**Subgrade Manipulation**” as described herein, on the foundation.

10. Pathway or Roadway Embankment Construction – The pathway or roadway “embankment” definition is the construction of earth on the prepared foundation to form the subgrade. Complete pathway or roadway embankment in accordance with subsection 205.03 H of the MDOT 2012 Standard Specifications for Construction as shown on the plans, and as specified herein. Compact pathway or roadway embankment to a minimum of 95% of its maximum unit weight, as measured by the AASHTO T-180 method.

11. Subgrade Construction - The pathway or roadway “subgrade” definition is the final earth grade that extends from grading limit to grading limit. Construct the subgrade by performing earth excavation and embankment work in accordance with subsection 205.03.G and subsection 205.03 H of the MDOT, respectively, of the 2012 Standard Specifications for Construction, as shown on the plans, and as specified herein.

Construct the subgrade to the contours and cross-sections shown on the plans, as specified herein, and as directed by the Engineer. To achieve this, the work will include, but not be

limited to:

- A. Removal and disposal off-site of any surplus or unsuitable materials.
- B. Furnishing from off-site any additional Engineer approved fill materials necessary.
- C. Moving existing and/or furnished materials longitudinally and transversely as necessary.
- D. Cutting, placing, compacting, and trimming existing and/or furnished materials to construct the pathway or roadway embankment and subgrade to the specified tolerances.
- E. Stockpiling, and moving again, any excavated materials requiring delayed placement due to construction staging.

Grade the earth subgrade to accommodate all pathway or roadway subbases and aggregate bases; all infiltration trench, bioswale and adjacent planting bed materials; curb and gutter, driveways, sidewalks, and other structures; infiltration trench and bioswale planting mixes, and topsoil; and any other features that the subgrade supports.

Prepare the subgrade to ensure uniform support for the pavement structure. Place the finished subgrade to within 1 inch below and $\frac{3}{4}$ inch above plan grade. Variations within this tolerance will be gradual.

Compact subgrade to a minimum of 95% of its maximum unit weight, as measured by the AASHTO T-180 method, to a depth of 10 inches. If this is not achievable, in the opinion of the Engineer, perform "**Subgrade Undercutting, Type __**" or "**Subgrade Manipulation**" as described herein, on the foundation.

Use equipment and methods of construction best suited, in the opinion of the Engineer, to perform the earthwork operations and meet the project requirements. The use of various equipment and methods of construction are subject to the approval of the Engineer. The Engineer may disallow the use of certain equipment and methods of construction and require the use of other equipment and/or methods of construction.

13. Test Rolling - Test-roll the foundation and/or subgrade with a pneumatic tired roller with a suitable body for ballast loading and a variable gross load capacity between 25 and 40 tons. Instead of this test roller, with the approval of the Engineer, the Contractor may use a fully loaded single axle or tandem axle dump truck.

14. Subgrade Undercutting – Perform "subgrade undercutting" on the foundation or subgrade in accordance with section 205.03.E of the MDOT 2012 Standard Specifications for Construction, as shown on the plans, as specified herein, and as directed by the Engineer.

15. Subgrade Manipulation – Perform "subgrade manipulation" on the foundation or subgrade in accordance with section 205.03.F of the MDOT 2012 Standard Specifications for Construction, as shown on the plans, as specified herein, and as directed by the Engineer.

Where required, perform subgrade manipulation on the foundation or subgrade soils by thoroughly scarifying, blending, and mixing to a depth of 12 inches. Accomplish this work by means of a large diameter disc, motor grader, or other equipment approved by the

Engineer. Upon manipulation of the foundation or subgrade to the satisfaction of the Engineer and allow it dry, and compact the soil to 95% of its maximum dry density as measured by the AASHTO T-180 method. The time required for drying the soil will not be a basis for an extension of time.

16. Rock Excavation – Remove of rocks and boulders, concrete and masonry. Perform rock excavation in accordance with section 205.03.B of the MDOT 2012 Standard Specifications for Construction, as shown on the plans, and as directed by the Engineer.

17. Lowering Structures - Prior to cutting the subgrade, remove structure covers, lower the structures to a point between 8 inches and 12 inches below the proposed subgrade, and cover the structures with a steel plate. Do not raise structures prior to placing pathway or roadway embankment.

Use steel plates for covering structure openings conforming to the plan detail and of sufficient thickness to carry any/all traffic loads, and prevent the infiltration of debris into the structures. Peg and properly place plates to prevent movement under all traffic.

Lower valve boxes to a point between 8 inches and 12 inches below the proposed subgrade. Do not raise valve boxes prior to placing pathway or roadway embankment.

Backfill the voids in the grade above the steel plates used for structure lowering and valve box lowering, and compact it to 95% of its maximum dry density, with an Engineer approved coarse aggregate.

Coordinate the lowering of any private and/or non-city owned utility structure with the private utility company/owner.

18. Structure Covers - As directed by the Engineer and within two days of their removal, the stockpile on-site, in a location that is mutually agreeable to the Engineer and Contractor, the existing structure covers. City of Ann Arbor forces will pick-up the structure covers at a time that is convenient to them and mutually agreeable to the Contractor. Provide equipment and personnel to load the castings on City vehicle(s) for removal from the site by the City forces.

19. Structure and Sewer Cleanliness – Protect all sewers, and structures, including manholes, gate wells, valve boxes, inlet structures and curbs from damage and contamination by debris and construction materials. Maintain structures clean of construction debris and properly cover them at all times during the construction. The Contractor will immediately clean any structures and/or sewers contaminated with construction debris.

20. Tree Trimming - The Contractor shall coordinate with the City of Ann Arbor Public Works to schedule trimming of trees by City forces or an authorized subcontractor.

d. Measurement and Payment. Measure and pay for the completed work, as described, at the contract unit price using the following pay item:

<u>Pay Item</u>	<u>Pay Unit</u>
Machine Grading, Special	Square Yard

Measure **Machine Grading, Special** area by the unit square yard and pay for it at the contract unit price, which price includes costs for all labor, equipment and materials necessary to complete the work.

Due to the project nature there is a likely probability that some or all of the excavated material may not be suitable for use fill material. Consequently, there may be imbalances between the amount of earth excavation available for reuse as embankment, and the amount of embankment needed for the construction activities shown on the plans, or as directed by the Engineer. The unit price bid for this work includes the costs to address this probable imbalance and to furnish, stockpile and re-handle, place, and compact any Engineer approved material necessary to complete the work of constructing the embankment and subgrade to the cross sections shown on the plans.

The described work for **Machine Grading, Modified** includes the removal and offsite disposal of any surplus or unsuitable materials and the furnishing from off-site any additional Engineer approved fill materials necessary to construct the embankment and subgrade to the contours and cross-sections shown on the plans.

The Contractor, at its sole expense, will remedy, as directed by the Engineer, any damage to the foundation, pathway, or roadway embankment or subgrade caused by traffic or its operations.

The Engineer will not pay for separately the removal of conduit or pipe, or any of the work, described in this section.

The Engineer will not pay additional compensation or allow extensions of contract time for additional measures required to protect the grade as specified.

Machine Grading, Modified includes costs for all labor, equipment and materials necessary to complete any subgrade undercutting and/or subgrade manipulation unless the Contract includes separate pay items for this work.

Rock excavation will apply only to removal of rocks and boulders, concrete and masonry less than $\frac{1}{2}$ cubic yard in volume. Measure boulders individually and compute the volume from the average dimension measured in three directions. If included in Contract, the Engineer will pay for the quantity exceeding $\frac{1}{2}$ cubic yard in volume as **Rock Excavation**, otherwise it will pay for as extra work.

The Contractor is responsible for all direct and indirect damages caused by unclean or damaged sewers or structures resulting from its work or operations.

The Engineer will not pay additional compensation or allow extensions of contract time for tree trimming measures and coordination of this work with City forces.

CITY OF ANN ARBOR
DETAILED SPECIFICATION
FOR
UNDERCUTTING

AA:DAD

1 of 2

03/23/20

a. Description. This work includes the removal of existing unstable and/or unsuitable base, subbase and/or subgrade soil material(s) that may be susceptible to frost heaving or differential frost action in the areas and limits identified by the Engineer. It also includes installing stabilization geotextile and/or structural geogrid as necessary and backfilling to replace these material(s) and remedy the unstable soil conditions. Perform this work in accordance with section 205 of the Michigan Department of Transportation (MDOT) 2012 Standard Specifications for Construction, as directed by the Engineer, and as modified herein.

b. Materials. Provide Granular Material Class II and 21AA dense-graded aggregate materials in accordance with those specified in section 902 of the MDOT 2012 Standard Specifications for Construction.

Provide Coarse Aggregate 3x1 in accordance with sections 902 and 916 the MDOT 2012 Standard Specifications for Construction, except as modified herein. Coarse crushed aggregate must consist of a well graded crushed natural aggregate ranging from one (1) inch to three (3) inch inches in size with no more than 7 percent by weight passing the No. 200 sieve. Coarse aggregate crushed content must be at least 95%.

Provide stabilization geotextile materials in accordance with section 910 of the MDOT 2012 Standard Specifications for Construction.

Provide structural geogrid materials in accordance with the Detailed Specification for Structural Geogrid.

c. Construction. Use construction methods as described in subsection 205.03.E of the Standard Specifications for Construction, and as directed by the Engineer.

After either removing the pavement, performing rough/finish grading, and/or at the time of proof rolling, the Engineer will inspect the grade to determine the need for, and the limits of, undercuts. Excavate to the required depth, trim, shape, and re-compact the undercut areas as directed by the Engineer. Properly dispose of all excess materials.

Backfill areas of Undercutting, Type IIA with class 21AA dense-graded aggregate, areas of Undercutting, Type IIB with Granular Material Class II, and areas Undercutting, Type IIC with Coarse Aggregate 3x1 unless directed otherwise by the Engineer.

Place stabilization geotextile and structural geogrid as directed by the Engineer in areas where subgrade soils require added stability. Place stabilization geotextile as directed by the Engineer in areas where is the potential of intermixing of dissimilar materials.

Place and compact the aggregate fill in maximum lifts of not more than 12 inches thick. At the discretion of the Engineer, aggregate fill lifts of up to 24 inches may be allowed based on the assessment of subgrade soil conditions.

Compact undercutting backfill material (>12 inches below the finish base grade) to not less than 95% of its maximum unit weight. Compact undercutting backfill material (≤12 inches below the finish base grade) to not less than 98% of its maximum unit weight. Determine the maximum unit weight of backfill materials using the AASHTO T-180 test.

The Engineer may elect to use one or more types of undercutting to address poor soil conditions identified in a specific area of the project.

d. Measurement and Payment. Measure and pay for the completed work, as described, at the contract unit prices using the following pay items:

<u>Pay Item</u>	<u>Pay Unit</u>
Undercutting, Type IIA.....	Cubic Yard
Undercutting, Type IIB.....	Cubic Yard
Undercutting, Type IIC	Cubic Yard

Measure **Subgrade Undercutting, Type IIA, Subgrade Undercutting, Type IIB, and Subgrade Undercutting, Type IIC** volumes in place by the unit cubic yard and pay for them at their respective contract unit prices, which prices include the costs for all labor, equipment and materials necessary to complete the work.

When one or more than types of undercutting are used to address poor soil conditions identified in a specific area of the project, each type will be measured and paid for separately.

Stabilization geotextile and structural geogrid will each be measured and paid for separately.

CITY OF ANN ARBOR

DETAILED SPECIFICATION
FOR
SOIL EROSION AND SEDIMENTATION CONTROL – INLET FILTER

AA:DAD

1 of 1

03/11/18

a. Description. This work consists of installing and maintaining inlet filters, as shown on the plans, in accordance with section 208 of the Michigan Department of Transportation (MDOT) 2012 Standard Specifications for Construction and. Install filters in existing and proposed inlets to restrict and minimize amounts of sediment entering into the storm sewer system and water courses. The related work includes the installation, maintenance and removal of the filter cloth, cleaning as required during the performance of the project work, removing and disposing of accumulated sediment, and replacement of filters if required by the Engineer to provide a properly working inlet filter and a well-drained site.

b. Materials. The following devices are approved for use as acceptable alternatives:

1. Siltsack Type B, Regular Flow, by ACF Environmental, Inc.
2. Inlet Pro Sediment Bag, Standard Flow, with optional foam deflector by Hanes GeoComponents.
3. Dandy Curb Bag, Dandy Bag, Dandy Curb Sack, Dandy Sack, or Dandy Pop by Dandy Products, Inc.
4. Basin Bag, Regular Flow by CSI Geoturf.

The Contractor shall submit product data sheets and a sample of the filter material used for inlet filters to the Engineer for approval prior to ordering materials.

c. Construction. The Contractor shall install, maintain, clean, and re-install and/or replace inlet filters in accordance with the manufacturer’s specifications and as directed by the Engineer. The Contractor shall dispose of debris off-site.

d. Measurement and Payment. Measure and pay for the completed work, as described, at the contract unit price for the following pay item:

<u>Pay Item</u>	<u>Pay Unit</u>
Erosion Control, Inlet Filter	Each

Measure **Erosion Control, Inlet Filter** individually in place by unit each and pay for it at the contract unit price, which price includes all costs for labor, equipment and materials necessary to furnish, install, maintain, clean and remove the inlet filter, and to re-install and/or replace the inlet filter as needed.

CITY OF ANN ARBOR
DETAILED SPECIFICATION
FOR
AGGREGATE BASE

AA:DAD

1 of 1

03/11/19

a. Description. This work consists of constructing an aggregate base course on a surface approved by the Engineer using only crushed limestone. The aggregate base shall be in accordance with section 302 of the 2012 Michigan Department of Transportation (MDOT) Standard Specifications for Construction, except as herein modified:

b. Material. Provide aggregate material meeting the requirements for Class 21AA dense-graded aggregate as specified in section 902 of the MDOT 2012 Standard Specifications for Construction. The ONLY permitted material shall be crushed limestone unless otherwise approved by the Engineer.

c. Construction. Construct aggregate base course in accordance with subsection 302.03 of the 2012 MDOT Standard Specifications for Construction. Deliver Class 21AA dense-graded aggregate to the job site in a thoroughly blended condition and handle in such a manner that there will be no mixing of underlying soil with the base aggregate.

d. Measurement and Payment. Measure and pay for the completed work, as described, at the contract unit prices using the following pay items:

<u>Pay Item</u>	<u>Pay Unit</u>
Aggregate Base, Modified	Ton
Aggregate Base, 8 inch, Modified	Square Yard
Aggregate Base, 10 inch, Modified	Square Yard

Measure **Aggregate Base, Modified** weight by the unit ton and pay for it at contract unit price, which price includes costs for all labor, equipment and materials necessary to complete the work. Load weight tickets from a certified scale and accepted at the job site by the City's agent will be the basis for measurement.

Measure **Aggregate Base, 8 inch, Modified** and **Aggregate Base, 10 inch, Modified** compacted in place area respectively by the unit square yard and pay for them at their respective contract unit prices, which prices include costs for all labor, equipment and materials necessary to complete the work.

Weigh any/all unused/waste material on a certified scale to determine quantity(s), unless the Engineer approves an alternate method to arrive at these amount(s). Provide load weight tickets to the City's agent for any/all unused/waste material.

CITY OF ANN ARBOR
 DETAILED SPECIFICATION
 FOR
STRUCTURAL GEOGRID

OHM:BA/AA:DAD

1 of 3

3/11/2019

a. Description. This work consists of placing structural geogrid as shown in the plans, and as directed by the Engineer. Perform work in accordance with section 308 of the 2012 Michigan Department of Transportation (MDOT) Standard Specifications for Construction, except as herein provided.

b. Material. Furnish geogrid manufactured with high profile rectangular shaped ribs oriented radially in three or more directions to form uniform triangular shaped apertures having significant dimensional stability through all ribs and junctions of the geogrid structure to maintain reinforcement and aggregate confinement capabilities under repeated dynamic loads throughout the pavement life cycle. Furnish geogrid material resistant to ultraviolet degradation, all forms of biological and chemical degradation, and physical damage normally encountered in earth and road construction activities. Furnish geogrid having three-dimensional ribs with a depth to width ratio of at least 1.0 to optimize aggregate interlock, and the physical and geometric properties specified in Table 1 below for the designated 'Type' of geogrid material shown on the plans.

Table 1. Geogrid Properties

Property	Test Method	TYPE			
		Subbase	Subgrade	Base	High Performance (HP) Base
Aperture (Aggregate) Size		Small (Fine)	Large (V. Coarse)	Standard	Standard
Nominal Pitch ⁽²⁾ , mm		33	60	40	40
Junction Efficiency ⁽³⁾ , %	ASTM D6637-10 D7737-11	93	93	93	93
Aperture Stability ⁽⁴⁾ , kg-cm/deg @ 5.0 kg-cm	GRI-GG9 (Modified)	-	3.0	3.0	3.6
Radial Stiffness at Low Strain ⁽⁵⁾ , kN/m @ 0.5% Strain	ASTM D6637-10	200	350	225	300
Isotropic Stiffness Ratio ⁽⁶⁾		-	0.6		
Overall Flexural Rigidity, mg-cm	ASTM D7748-12	0.5x10 ⁶	2.0x10 ⁶		
Chemical Resistance ⁽⁷⁾	EPA 9090	100%	100%	100%	100%
Resistance to Ultra-Violet Light and Weathering ⁽⁸⁾	ASTM D4355-05	70%	70%	70%	70%

1. Unless indicated otherwise, values shown are minimum average roll values (MARVs) determined in accordance with ASTM D4759-02. Brief descriptions of test procedures are given in the following notes.
2. Height of (triangular) aperture, measured node axis to rib.
3. Load transfer capability expressed as a percentage of ultimate tensile strength.
4. In-plane torsional rigidity measured by applying a moment to the central junction of a 225mm x 225mm specimen restrained at its perimeter.
5. Radial stiffness is determined from tensile stiffness measured in any in-plane axis from testing.

- 6. The ratio between the minimum and maximum observed values of radial stiffness at 0.5% strain, measured on rib and midway between rib directions.
- 7. Resistance to loss of load capacity or structural integrity when subjected to immersion testing in chemically aggressive environments.
- 8. Resistance to loss of load capacity or structural integrity when subjected to 500 hours of ultraviolet light and aggressive weathering.

Submit representative geogrid product sample, product data sheet, and the manufacturer’s published installation guidelines. Basis for acceptance will be on a general certification, along with a certificate of analysis that confirms the geogrid material supplied meets the requirements of Table 1. The Engineer may sample and test material shipped to the project to verify certification documents.

The Engineer may consider alternate geogrid materials if they meet or exceed the project design intent. The Engineer must pre-approve alternate materials in writing by the Engineer prior to installation. Submit performance test data for evaluation at least two weeks prior to the anticipated shipment to the project. The Engineer will accept in-air laboratory testing alone for performance testing. Where applicable, calibrate the alternate geogrid material to the selected pavement design methodology furnish verification. The Engineer retains the sole discretion to approve alternate materials based on the submittal. Rejection of alternate material submittals shall not be the basis for any claim for additional compensation nor extension of time.

c. Construction. Protect stored materials from exposure to mud, wet concrete, epoxy or other deleterious materials. Store at temperatures above -20°F (-29°C). Lay flat or stand on end rolled materials. Do not store geogrid materials exposed to direct sunlight for extended periods as recommended by the manufacturer. The Engineer will reject geogrid materials with damage or manufacturing defects.

Prepare all areas immediately beneath the geogrid installation area per the plans and pertinent specifications. Install geogrid according to the manufacturer's recommendations. Place geogrid required only for immediately pending work to prevent undue exposure or damage to the geogrid, not to exceed 3 calendar days. After placing a layer of geogrid, use approved suitable means to anchor the geogrid in position until the subsequent backfill layer can be placed. Overlap adjacent rolls of geogrid as directed to maintain at least 1 ft overlap after backfill placement (larger overlaps may be necessary on softer subgrade soils).

Do not operate equipment directly on the geogrid. Place backfill outward from road embankment centerline, pushing a sufficient aggregate surcharge to assist in tensioning the geogrid without creating excessive wrinkles or damage. Do not operate tracked equipment on less than 6 inches of loose aggregate. Avoid sudden braking and sharp turning movements to prevent damage to the geogrid. Grade and compact cover aggregate according to the plans and relevant contract item specifications.

d. Measurement and Payment. Measure and pay for the completed work, as described, at the contract unit price using the following pay item:

<u>Pay Item</u>	<u>Pay Unit</u>
Structural Geogrid (Type).....	Square Yard

Measure **Structural Geogrid (Type)** in place area by the unit square yard and pay for it at contract unit price, which price includes costs for all labor, equipment and materials necessary to complete

the work including placement and anchoring, hand work necessary to establish grades, splicing, and repairing protective coatings. The Engineer will make no allowance for overlap, splices, or material cut off or wasted.

CITY OF ANN ARBOR
DETAILED SPECIFICATION
FOR
FLEXIBLE PIPE COUPLING

AA:DAD

1 of 1

03/11/19

a Description. Use flexible pipe coupling to adjoin pipes of different sizes or materials as directed by the Engineer, and as described herein.

b Materials. Use FerncoTM Flexible coupling with stainless steel shear rings; Indiana Seal Flexible Couplings; or an Engineer approved equal.

c Construction. Install flexible coupling per the specifications of the manufacturer, and provide stainless steel shear rings regardless of pipe bedding conditions.

d Measurement and Payment. Prior to payment for this item, the Contractor shall submit its receipt(s) from the manufacturer or supplier to the Engineer. Receipt(s) should detail the cost of each coupling and related components including shipping charges and taxes. The Engineer will review and approve these costs and pay for them as an extra to the contract. The Contractor shall include all labor and equipment costs necessary to install the flexible pipe coupling(s) in the contract unit price(s) for the pay item(s) directly associated with this work.

CITY OF ANN ARBOR
DETAILED SPECIFICATION
FOR
ADJUSTING STRUCTURE COVERS

AA:DAD

1 of 3

03/11/19

a. Description. This work includes the final adjustment of all drainage and utility structure covers whether shown or not on the plans in accordance with section 403 of the Michigan Department of Transportation (MDOT) 2012 Standard Specifications for Construction, applicable standard or special details, and as specified herein. Utility structures comprise gate valve wells/manholes, sanitary sewer manholes, gate valve boxes, monument boxes, and electrical/traffic signal handholes.

The Contractor will also coordinate with the private utility(s) any required adjustment(s) of structure covers to ensure performance of proper adjustments prior to placing any final paving materials.

b. Materials. Provide materials in accordance with those specified in subsection 403.02 of the MDOT Standard Specifications for Construction.

In hot mix asphalt (HMA) pavement areas, make adjustments using MDOT P-NC concrete (658 lbs/cyd) as specified in subsection 601.02 of the MDOT 2012 Standard Specifications for Construction. In areas of concrete (PCC) pavement, adjust structures at the time of paving and encase them with the grade of concrete used for the roadway.

c. Construction. Complete this work, as applicable, according to subsection 403.03 of the MDOT 2012 Standard Specifications for Construction, as described below, and as directed by the Engineer.

Adjust any/all structure covers, monument boxes, water valve boxes and other public utility underground access or control point covers to conform to the finished surface section and elevation. Perform the structure cover adjustments in lawn areas and those using a one-step process. Perform structure cover adjustments in HMA pavement areas in two steps: step one is the lowering of the structure cover to below the subgrade elevation and plating of the structure; step two is the final adjustment to finish grade made prior to placing the HMA top course. In areas of concrete pavement, make the final adjustment of structure covers to finish grade at the time of concrete pavement forming. The Engineer shall approve of all structure cover adjustments prior to the placement of any HMA and/or concrete pavement.

Any/all final structures cover adjustments are to be to the elevation that results in their top surface being flush with the finished grade. Accomplish and check this work using a 10-foot straight edge placed parallel, and then perpendicular to, the pavement centerline. Failure to meet these conditions will result in the readjustment of the structure and finish patching of the area, as directed by the Engineer, at the Contractor's expense.

All private utility (Electric, Gas, Telecommunications, etc.) structure and valve covers will be adjusted during this project by the Utility. It is the responsibility of the Contractor to coordinate with these private utilities by giving adequate notice and arranging for any adjustment of structures or valves by these utilities. The Contractor is solely responsible for ensuring completion of this work in a timely manner.

The Contractor shall replace existing structures covers, top portions of valve boxes and monument boxes as shown on the plans and as directed by the Engineer.

The Contractor shall remove and stockpile on site at a location mutually agreed upon by the Contractor and Engineer any/all existing structure covers designated for salvage and within two days of their removal deliverer them to the City’s W.R. Wheeler Service Center (4251 Stone School Rd, Ann Arbor, MI). Any structure covers not designated for salvage shall become the property of the Contractor, and disposed of, as required, by the Contractor.

Any/all adjustments in areas HMA pavement include backfilling with Grade P-NC concrete from the depth of excavation necessary for adjustment to an elevation flush with the HMA leveling course.

Adjust structure covers to be flush with or ¼ inch below final pavement surface.

d. Measurement and Payment. Measure and pay for the completed work, as described, at the respective contract unit prices using the following respective pay items:

<u>Pay Item</u>	<u>Pay Unit</u>
Dr Structure Cover, Adj, Case 1, Modified	Each
Dr Structure Cover, Adj, Case 2, Modified	Each
Monument Box, Adj.....	Each

Measure **Dr Structure Cover, Adj, Case 1, Modified** and **Dr Structure Cover, Adj, Case 2, Modified** and **Monument Box, Adj** individually in place by the unit each and pay for them at their respective contract unit prices, which prices include costs for all labor, equipment and materials necessary to complete the work.

Backfilling with Grade P-NC concrete is not a separate contract item, and payment for **Dr Structure Cover, Adj, Case 1, Modified** includes furnishing and placing this material.

Payment for transporting salvaged frames and covers from the project site to the W.R. Wheeler Center is included in the unit prices bid for the above structure cover adjustment items of work.

Where the required adjustment of a structure is more than 6 inches above/below the proposed finished grade of the structure, measure and pay for it as **Dr Structure Cover, Adj, Add Depth, Modified**. This also includes the repair of manholes and structures requiring less than the substantial rebuilding of the structure, as determined by the Engineer.

There is a possibility that the Contractor may find hidden utility structures during the work. It is the Contractor's responsibility to inform the respective utility owner(s) of the findings. In such instances, the City may direct the Contractor to adjust the structure(s) to grade. The Engineer will pay this work as either **Dr Structure Cover, Adj, Case 1, Modified** or **Dr Structure Cover, Adj, Case 2, Modified** depending on the location of the hidden structure(s).

The Engineer will pay for adjusting covers on new drainage or utility structures, monuments boxes, valve boxes, etc. in their respective items of work and not pay for them under these items of work. Perform this work in accordance with this detailed specification.

The Engineer will pay for the adjustment of gate valve boxes and electrical/traffic signal handholes as **Dr Structure Cover, Adj, Case ____, Modified** unless there are separate pay items in the contract to address this work.

CITY OF ANN ARBOR
DETAILED SPECIFICATION
FOR
DRAINAGE STRUCTURE, DOUBLE INLET

AA:DAD

1 of 1

03/11/19

a. Description. This work consists of constructing a double inlet drainage structure at the location(s) as shown on the plans in accordance with section 403 of the Michigan Department of Transportation (MDOT) 2012 Standard Specifications for Construction, the City of Ann Arbor Standard Detail SD-S-11 shown on the plans, as directed by the Engineer, and as described herein.

b. Materials. Provide materials in accordance with subsection 403.02 of the MDOT 2012 Standard Specifications for Construction.

c. Construction. Construct double inlet drainage structures in accordance with subsection 403.03 of the MDOT 2012 Standard Specifications for Construction.

d. Measurement and Payment. Measure and pay for the completed work, as described, at the contract unit price using the following pay item:

Pay Item

Pay Unit

Dr Structure, Double Inlet.....Each

Measure **Dr Structure, Double Inlet** in place by the unit each and pay for it at the contract unit price, which price includes all cost for labor, equipment and materials necessary to complete the work.

CITY OF ANN ARBOR
DETAILED SPECIFICATION
FOR
DRAINAGE AND UTILITY STRUCTURE RECONSTRUCTION

AA:DAD

1 of 3

03/05/20

a. Description. This work consists of reconstructing drainage and utility structures in accordance with section 403 of the Michigan Department of Transportation (MDOT) 2012 Standard Specifications for Construction, as shown on the plans, as directed by the Engineer, and as specified herein.

b. Materials. Provide materials in accordance with subsection 403.02 of the MDOT 2012 Standard Specifications for Construction except as specified herein.

Construct drainage structures of precast or cast in place reinforced concrete sections, or concrete masonry units. Construct all sanitary sewer manholes and gate wells (water main valve manholes) of precast reinforced concrete sections.

Use precast reinforced concrete bases, bottom sections, manhole risers, grade adjustment rings, concentric cones, eccentric cones, and flat slab tops conforming to the requirements of ASTM C 478. Joints on precast manholes used on all sanitary sewers will meet ASTM C 443, rubber O-ring gasket.

Use concrete masonry units conforming to the requirements for concrete masonry units for catch basins and manholes, ASTM C 139.

Use concrete brick conforming to the requirements for concrete building brick, ASTM C 55, Grade N-1.

Plastic coated manhole steps will be injection molded of copolymer, polypropylene, encapsulating a ½-inch grade 60 steel reinforcing bar. Plastic-coated manhole steps will meet the performance test described in ASTM C-478, Paragraph II, and have an impact resistance of 300 ft-lbs, with only minor deflection and no cracking or breaking. The steps will resist pull out forces of 1500 lbs.

c. Construction. Use construction methods for reconstructing drainage structures, where directed by the Engineer, conforming to subsection 403.03 of the MDOT 2012 Standard Specifications for Construction except as specified herein.

Excavate to the depth and width required to permit the construction of the required base. The excavation width will be greater than the base. Trim the bottom of the excavation to a uniform horizontal bed and completely dewater before placing any structure components.

Use concrete block construction only for storm sewer manholes and inlets and construct these structures to the size and dimensions shown on the plans. Use clean masonry block units, place them in a full bed of mortar, and thoroughly bond them together in place by completely filling the vertical end grooves with mortar to interlock them with the adjacent blocks. The mortar beds and joints will not exceed ¾ inch thickness. Completely fill vertical joints and fill joints on the inside face of the structure by rubbing them full of mortar and striking them smooth as construction proceeds vertically. Place and strike smooth a ½" thick mortar coat on the entire outside face of

the structure. Heat all masonry materials, sand, and water to over 50° F during freezing weather and cover and protect the completed work from damage by freezing.

Construct circular precast manhole sections in accordance with the details as shown on the plans. Construct manhole stack units on level poured-in-place bases, precast concrete bases, or precast concrete bottom sections.

Construct precast cone sections in accordance with the details as shown on the plans. These units will be eccentric for all manholes, precast or block. Top all structures with a minimum of one and a maximum of three adjustment courses. Adjustment courses will be 2 inches in height and constructed using bricks or precast adjustment rings.

Construct manholes, inlets, gate wells, and other structures within 2-1/2 inches of plumb.

Frames and cover castings will be set in full mortar beds and pointed on the structure interior to a smooth, brushed finish. The covers will be set flush with sidewalk, roadway pavement, or ground surfaces. Notify the Engineer prior to the final paving to allow inspection of the final casting adjustments for all utility structures. In gravel streets, set covers six to eight inches below finished gravel surface.

Extend sewer pipes into structures a minimum of 1/2 inch and a maximum of 3 inches.

Finish flow channels for sewer structures in accordance with the details as shown on the plans. Screed and float all flow channels to a smooth, uniform surface and troweled to a hard surface finish.

Furnish and place stubs for future sewer connections as shown on the plans and as directed by the Engineer. Properly support and brace connections when they are not resting on original ground so that any settlement will not disturb the connection. Stubs will consist of one length of sewer pipe, of the size indicated on the plans, with a watertight plug.

Keep the excavation in a dry condition.

Sealing Manhole Cone/Chimney Interface Area:

Place an epoxy or urethane sealing product at the junction of the drainage structure cone/chimney interface as detailed on the plans or as directed by the Engineer. Use only products approved by the Engineer and manufactured by one of the suppliers listed below:

NPR-3501 Neopoxy (epoxy) manufactured by NeoPoxy International, 27057 Industrial Boulevard, Hayward, CA 94545, Phone 510.782.1290, Fax 510.782.1292 (www.NeoPoxy.us)

EasySeal SG (urethane) manufactured by Cretex Specialty Products, N16 W23390 Stone Ridge Drive, Suite A, Waukesha WI 53188, Phone 800 345 3764, Fax 262.542.0301 (www.cretexseals.com)

Flex-Seal (urethane) manufactured by Sealing Systems, Inc, 9350 County Road 19, Loretto, MN 55357, Phone 800-478-2054, Fax 763-478-8868 (www.ssiselingsystems.com)

For the purposes of this work, the definition of the manhole chimney is the masonry units sitting atop the pre-cast concrete or manhole block corbel or cone sections and extending up to the bottom of the drainage structure cover. Apply sealant to the entire chimney section. Thoroughly clean the chimney section as detailed in the installation instructions of the sealant manufacturer. Apply all products in strict accordance with the recommendations and installation requirements of the manufacturer. The Engineer will approve the chosen sealing product prior to commencement of the work.

d. Measurement and Payment. Measure and pay for the completed work, as described, at the contract unit price for the following pay item:

<u>Pay Item</u>	<u>Pay Unit</u>
Structure, Reconstruct	Each

Measure **Structure, Reconstruct** in place by unit each and pay for it at the contract unit price, which price includes all costs for labor, equipment and materials to complete the work. It also includes any/all costs necessary for dewatering and adjustments required to accommodate field conditions encountered during construction.

CITY OF ANN ARBOR
 DETAILED SPECIFICATION
 FOR
DRAINAGE AND UTILITY STRUCTURES

AA:DAD

1 of 1

03/10/18

a. Description. This work consists of cleaning, pointing, and temporary lowering drainage and utility (storm, sanitary, and water) structures whether shown or not on the plans, as directed by the Engineer, and as herein provided.

b. Materials. Provide materials in accordance with subsection 403.02 of the Michigan Department of Transportation (MDOT) 2012 Standard Specifications for Construction, unless otherwise directed by the Engineer.

c. Construction. Clean, point, and temporary lower drainage and utility structures in accordance with subsection 403.03 of the MDOT 2012 Standard Specifications for Construction, and as directed by the Engineer.

Reconstruct drainage and utility structures from the base using precast reinforced concrete units or concrete block masonry.

Point structures by removing loose and damaged mortar, filling joints between concrete and masonry units with new mortar, and striking joints so the exposed surface is smooth and free of voids.

d. Measurement and Payment. Measure and pay for the completed work, as described, at the respective contract unit prices using the following respective pay items:

<u>Pay Item</u>	<u>Pay Unit</u>
Dr Structure, Cleaning, Modified	Each
Dr Structure, Point.....	Each
Dr Structure, Temp Lowering, Modified	Each

Measure **Dr Structure, Cleaning, Modified**; **Dr Structure, Point**; and **Dr Structure, Temp Lowering, Modified** individually in place by their respective units each and pay for them at their respective contract unit prices, which prices include the costs for all labor, equipment and materials necessary to complete the work.

CITY OF ANN ARBOR
 DETAILED SPECIFICATION
 FOR
STRUCTURE COVERS

AA:DAD

1 of 2

03/11/19

a. Description. This work shall consist of replacing and furnishing frames and covers for utility (storm, sanitary, and water) structures as shown on the plans and as directed by the Engineer, in accordance with section 403 of the edition of the Michigan Department of Transportation (MDOT) 2012 Standard Specifications for Construction, except as specified herein.

b. Materials. Provide materials meeting the requirements of subsection 403.02 and section 908 of the MDOT 2012 Standard Specifications. Provide frames and covers conforming to the model(s) shown in the table below, or equivalent approved by the Engineer.

Type of Casting	Associated Pay Item (MDOT Designation)	EJ No.	NEENAH No.
Manhole Frame and Cover (sanitary sewer)	Dr Structure Cover, Special	1040AGS	
Manhole Frame and Cover (storm sewer and water)	Dr Structure Cover, Type B, Modified (Cover B)	1040 w/ Type A Cover Type M1	
Curb Inlet/Catch Basin Frame and Cover (mountable curb & gutter)	Dr Structure Cover, Type C, Modified (Cover C)	7045Z w/ 7045M1 Sinusoidal Grate	R-3249F
Flat Inlet Frame and Cover	Dr Structure Cover, Type D, Modified (Cover D)	5000 w/ Type M2 Sinusoidal Grate	
Inlet/Catch Basin Frame and Cover	Dr Structure Cover, Type E, Modified (Cover E)		
Inlet/Catch Basin Frame and Cover	Dr Structure Cover, Type G, Modified (Cover G)		
Curb Inlet/Catch Basin Frame and Cover (barrier curb & gutter)	Dr Structure Cover, Type K, Modified (Cover K)	7045Z w/ 7045M1 Sinusoidal Grate	R-3249F

Provide frames and covers with machined bearing surfaces.

Provide manhole covers labeled with "CITY OF ANN ARBOR" and "WATER","STORM", or "SANITARY" whichever is applicable. Use the City's custom logo in use at the time of the project (see drawings attached).

Use Dr Structure Cover, Special for all sanitary sewer manhole covers unless otherwise directed by the Engineer.

Frames and covers for monument and gate (water-valve) boxes will be provided by the City of Ann Arbor. The Contractor shall transport these to the site from the City's W.R. Wheeler Service Center located at 4251 Stone School Road.

c. Construction. The Contractor shall store materials on site and/or at locations arranged by the Contractor, subject to the approval of the Engineer. The Contractor shall not store materials or equipment, including metal castings and steel plates, on any lawn areas.

The Contractor shall deliver all salvaged covers and castings to the W.R. Wheeler Service Center within two days of their removal.

d. Measurement and Payment. Measure and pay for the completed work, as described, at the respective contract unit prices using the following respective pay items:

<u>Pay Item</u>	<u>Pay Unit</u>
Dr Structure Cover, Type B, Modified	Each
Dr Structure Cover, Type D, Modified	Each
Dr Structure Cover, Type E, Modified	Each
Dr Structure Cover, Type G, Modified	Each
Dr Structure Cover, Type K, Modified	Each
Dr Structure Cover, Special	Each

Measure **Dr Structure Cover, Type ____, Modified** and **Dr Structure Cover, Special** individually in place by their respective units each and pay for them at their respective contract unit prices, which prices include all cost for labor, equipment and materials necessary to complete the work.

Payment for transporting new covers to the project site from the W.R. Wheeler Center is included in the unit prices bid for the above drainage structure cover items of work.

1040A Cover

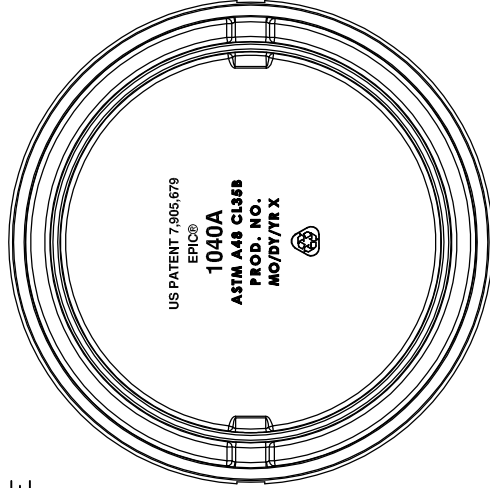
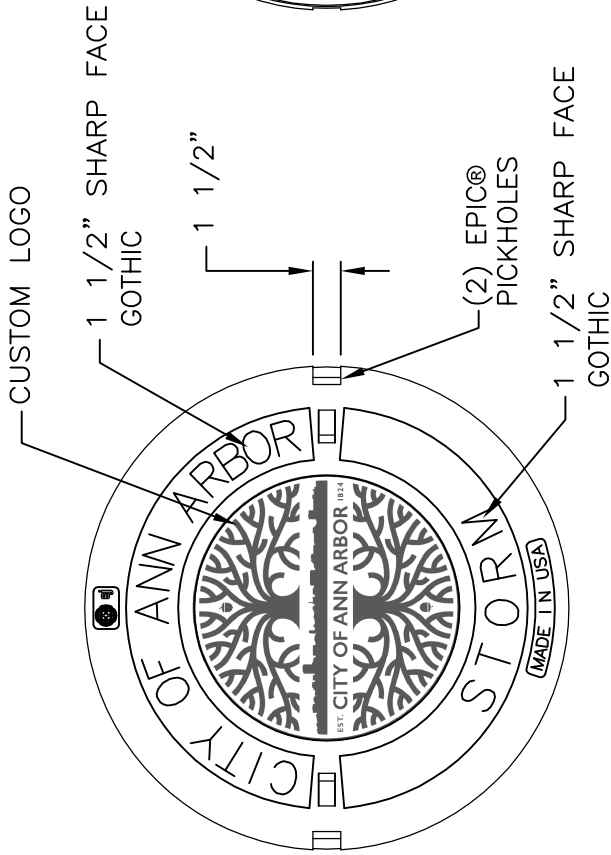

BOTTOM VIEW

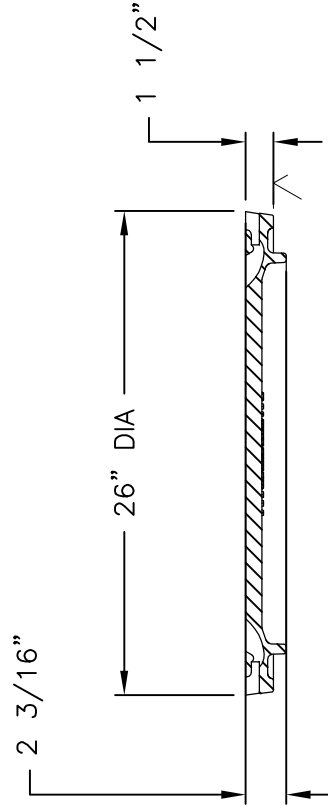

SECTION

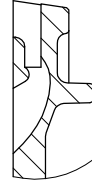

EPICOR® DETAIL

Product Number

001040325

Design Features

- Materials Gray Iron (CL35B)
- Design Load Heavy Duty
- Open Area n/a
- Coating Dipped
- Designates Machined Surface

Certification

- ASTM A48
- Country of Origin: USA

Drawing Revision

5/4/2018 Designer: DAE
8/29/2018 Revised By: DAE

Disclaimer

Weights (lbs./kg) dimensions (inches/mm) and drawings provided for your guidance. We reserve the right to modify specifications without prior notice.

CONFIDENTIAL: This drawing is the property of EJ GROUP, Inc., and embodies confidential information, registered marks, patents, trade secret information, and/or know how that is the property of EJ GROUP, Inc. Copyright © 2012 EJ GROUP, Inc. All rights reserved.

Contact

800 626 4653
ejco.com

1040A Cover

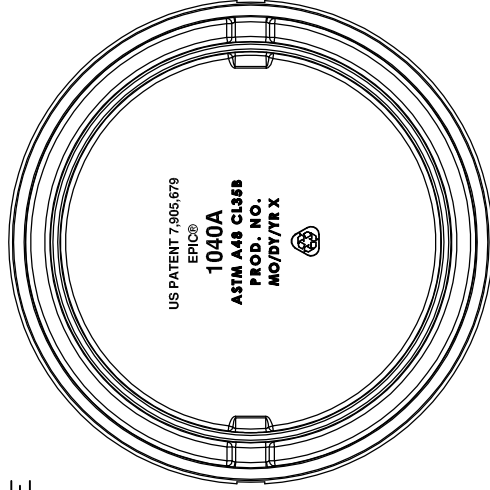
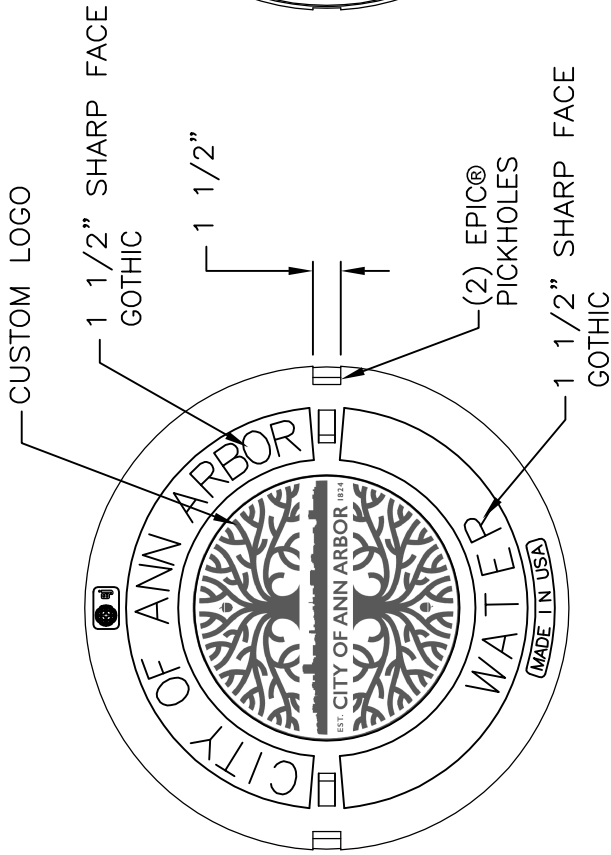

BOTTOM VIEW

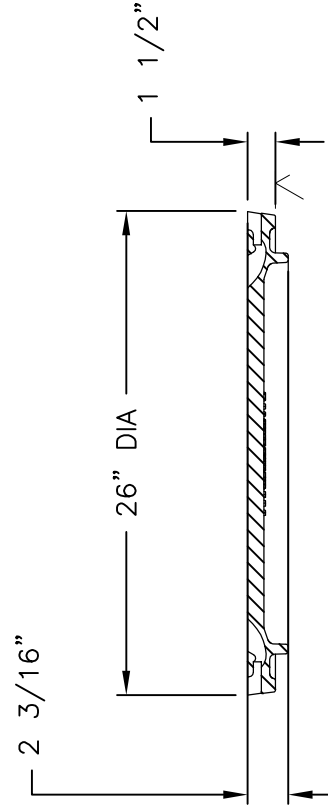

SECTION

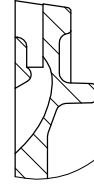

EPICOR® DETAIL

Product Number

001040324

Design Features

- Materials Gray Iron (CL35B)
- Design Load Heavy Duty
- Open Area n/a
- Coating Dipped
- Designates Machined Surface

Certification

- ASTM A48
- Country of Origin: USA

Drawing Revision

5/4/2018 Designer: DAE
8/29/2018 Revised By: DAE

Disclaimer

Weights (lbs./kg) dimensions (inches/mm) and drawings provided for your guidance. We reserve the right to modify specifications without prior notice.

CONFIDENTIAL: This drawing is the property of EJ GROUP, Inc., and embodies confidential information, registered marks, patents, trade secret information, and/or know how that is the property of EJ GROUP, Inc. Copyright © 2012 EJ GROUP, Inc. All rights reserved.

Contact

800 626 4653
ejco.com

1040AGS Cover

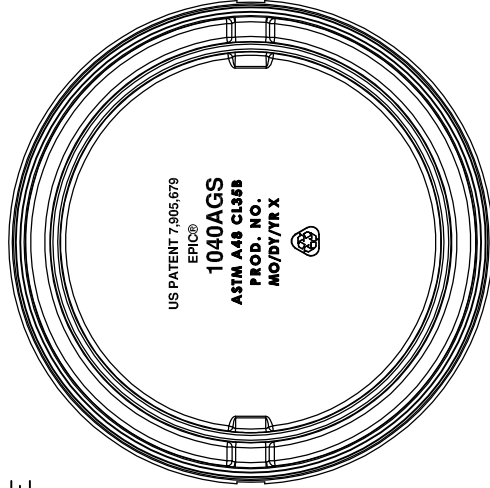
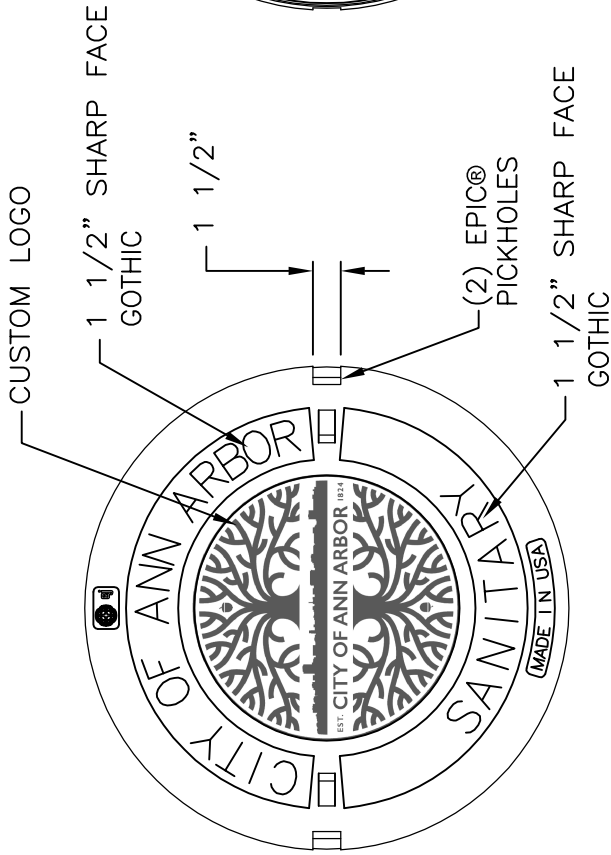

BOTTOM VIEW

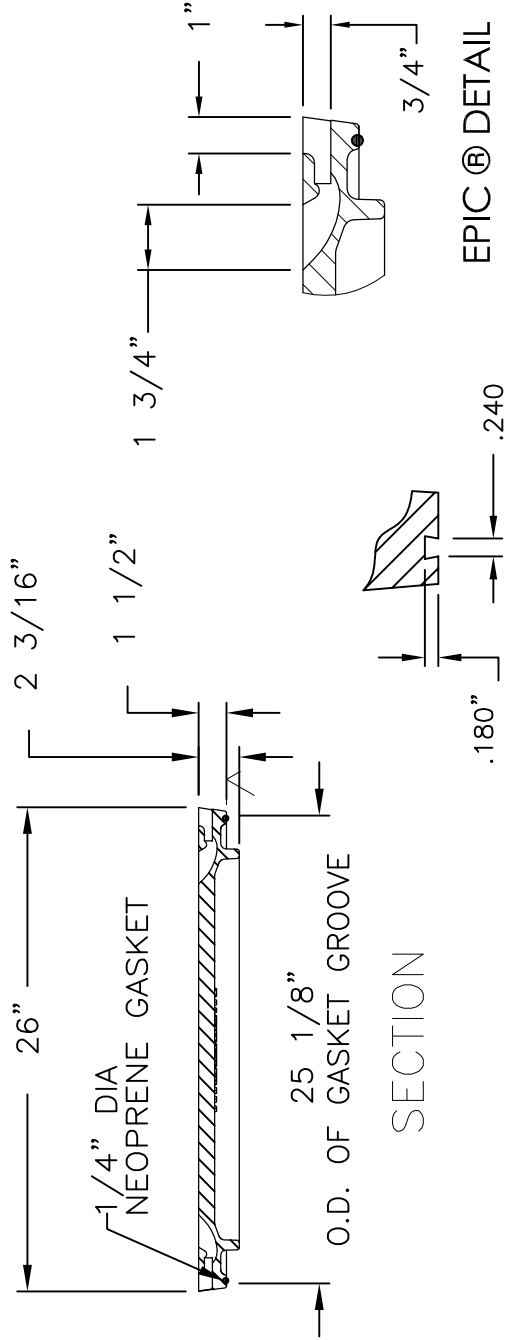

SECTION

EPIC® DETAIL

GROOVE DETAIL

Product Number

001040326

Design Features

- Materials Gray Iron (CL35B)
- Design Load Heavy Duty
- Open Area n/a
- Coating Dipped
- Designates Machined Surface

Certification

- ASTM A48
- Country of Origin: USA

Drawing Revision

5/11/2018 Designer: DAE
8/29/2018 Revised By: DAE

Disclaimer

Weights (lbs./kg) dimensions (inches/mm) and drawings provided for your guidance. We reserve the right to modify specifications without prior notice.

CONFIDENTIAL: This drawing is the property of EJ GROUP, Inc., and embodies confidential information, registered marks, patents, trade secret information, and/or know how that is the property of EJ GROUP, Inc. Copyright © 2012 EJ GROUP, Inc. All rights reserved.

Contact

800 626 4653
ejco.com

CITY OF ANN ARBOR
DETAILED SPECIFICATION
FOR
SUBGRADE UNDERDRAIN

AA:DAD

1 of 2

03/11/19

a. Description. The work consists of installing 6-inch geotextile-wrapped perforated or slotted underdrain whether or not shown on the plans in accordance with section 404 of the Michigan Department of Transportation (MDOT) 2012 Standard Specifications for Construction, applicable standard or special details, as described herein, and as directed by the Engineer.

b. Material. Provide materials meeting the requirements specified in subsection 404.02 of the MDOT 2012 Standard Specifications for Construction, and as specified herein:

Fine Aggregate, 2NS.....	902
Underdrain Pipe, Perforated or Slotted	909.07.B

Geotextile (Filter Fabric) – Use approved geotextile fabric for encasing the pipe such as nylon, polypropylene, fiberglass, or polyester and that is either woven, heat bonded, knitted or of continuous fibers. In a loose unstrained condition, knitted polyester fabrics will weigh at least 3.0 ounces per square yard and all other geotextiles will weigh at least 3.5 ounces per square yard. The fabric will be strong and tough and have porosity such that the fabric will retain soil particles larger than 0.106 mm (No. 140 sieve) and will pass aggregate particles finer than 0.025mm. Store and handle geotextiles carefully and in accordance with the manufacturer's recommendations and do not expose them to heat or direct sunlight to such extent as to significantly affect its strength or toughness. Do not use torn or punctured geotextiles.

c. Construction Methods. Install geotextile-wrapped underdrain for subgrade drainage as shown on the plans and as specified in subsection 404.03 of the MDOT 2012 Standard Specifications for Construction, with the following exceptions and additions:

1. Construct the trench to a minimum width of 18 inches and the install the underdrain at the line grade and depth as indicated on the plans. Maintain line and grade by means of a laser. The Engineer will not set line, grade or provide staking.
2. Backfill trench with 2NS Fine Aggregate compacted to 95% of its maximum unit weight. Place the first lift of backfill material at a maximum thickness of 6 inches. Place second and subsequent lifts, or portions thereof, at a maximum thickness of 12 inches up to an elevation level with the bottom of the existing aggregate base course, or as directed by the Engineer.
3. Close off upgrade ends of the pipe with suitable plugs to prevent entrance of any material. Manufacture and install all couplings, tees and other fittings to prevent infiltration of any material. If during the course of construction, the Contractor encounters existing underdrains or other drains, plug their ends to the satisfaction of the Engineer such that material cannot enter the pipe(s).
4. Tap downgrade ends of the pipe into existing or new drainage structures. However, it may be necessary to tap underdrain into either existing or new storm sewer, or into existing or new inlet leads as directed by the Engineer.

5. Construct trench bottom and edge drain to the percent of grade indicated on the plans or as determined by the Engineer, with the minimum percent of grade being 0.5%. In addition, construct the underdrain to have a minimum cover, from top of pipe to finished pavement grade, of 36 inches.

6. During the construction of underdrain runs, it may be necessary to terminate construction due to conflicts with buried obstructions or at such time when restricted by the minimum cover requirements. The Engineer will review conflicts on a case-by-case basis and make a decision on whether to continue installing pipe or terminate runs prematurely. The Engineer will not allow adjustment to the contract unit price or additional payments for changes in the contract quantity due to Engineer directed field changes associated with buried obstructions encountered during construction or other reasons.

7. Completely cover and secure the geotextile material to the pipe.

d. Measurement and Payment. Measure and pay for the completed work, as described, at the contract unit price for the following pay item:

<u>Pay Item</u>	<u>Pay Unit</u>
Underdrain, Subgrade, 6 inch, Special	Foot

Measure **Underdrain, Subgrade, 6 inch, Special** length in place by the unit foot and pay for it at the contract unit price, which price includes all cost for labor, equipment and materials necessary to complete the work.

The unit price includes the cost to furnish and install the 6-inch perforated or slotted pipe with geotextile wrap in addition to required pipe fittings and/or plugs. It also includes furnishing and placing and compacting 2NS granular bedding and trench backfill material, taps to new and existing drainage structures and storm sewers or inlet leads, all excavation, final trimming required to meet the dimensions of the typical and specific cross-sections, and the disposal of all surplus excavated materials.

CITY OF ANN ARBOR
DETAILED SPECIFICATION
FOR
COLD MILLING FOR CONCRETE CURB AND GUTTER REVEAL

AA:DAD

1 of 1

03/04/20

a. Description. This work consists of cold milling existing concrete curb and gutter areas overlaid with HMA material to reveal the edge-of-metal of the curb and gutter in accordance with section 501 of the Michigan Department of Transportation 2012 Standard Specifications for Construction, as directed by the Engineer, and as described herein.

b. Materials. None specified.

c. Construction. Perform localized cold milling along the concrete gutter pan overlaid with HMA to reveal the edge-of-metal of the existing concrete curb and gutter. Perform this work in accordance with subsection 501.03 of the MDOT 2012 Standard Specifications for Construction, and as directed by the Engineer at the location designated by the Engineer. Perform subsequent handwork and/or necessary machine work to remove HMA overlay material from the gutter pan, and dispose of this material properly.

d. Measurement and Payment. Measure and pay for the completed work, as described, at the contract unit price using the following pay item:

Pay Item	Pay Unit
Cold Milling for Concrete Curb and Gutter Reveal	Syd

Measure **Cold Milling for Concrete Curb and Gutter Reveal** weight by the unit ton and pay for it at the contract unit price, which price includes the cost for all labor, equipment and materials required to remove, load, haul, and dispose of the cold milled material, and cleaning the cold milled surface. The Engineer will not pay for material picked up by cleaning after cold milling.

CITY OF ANN ARBOR
 DETAILED SPECIFICATION
 FOR
HOT MIX ASPHALT (HMA) APPLICATION ESTIMATE

AA:DAD

1 of 2

02/19/21

a. Description. Perform this work in accordance with the requirements of section 501 of the Michigan Department of Transportation (MDOT) 2012 Standard Specifications for Construction, and as herein specified.

b. Materials.

PAY ITEM	HMA MIX	APPLICATION RATE	ESTIMATED THICKNESS	BINDER PERFORMANCE GRADE	AWI (min)
Packard Street Shared Use Path					
Shared use Path, HMA	LVSP	385 lb/syd	3.5 inches	PG 58-28	220
Shared use Path, HMA, Wedging	5E1	Varies between 55 and 250 lb/syd	Varies between 0.5 and 2.25 inches	PG 64-28	N/A
Minor (Local) Streets					
(1) HMA, LVSP	LVSP (top)	220 lb/syd	2.0 inches	PG 58-28	220
	LVSP (leveling)	220 lb/syd	2.0 inches	PG 58-28	N/A
(2) HMA, LVSP	LVSP (top)	165 lb/syd or 220 lb/syd	1.5 inches or 2.0 inches	PG 58-28	220
(3) Hand Patching	LVSP	Varies maximum = 330 lb/syd	Varies - maximum = 3.0 inches	PG 58-28	N/A
(4) HMA Approach	LVSP	Place in two courses/lifts at 220 lb/syd	Varies maximum = 2.0 inches/lift	PG 58-28	220
HMA, Wedging, 36A	36A	Varies between 110 and 330 lb/syd	Varies between 1.0 and 3.0 inches	PG 58-28	220

- (1) Applies to streets where asphalt pavement removal and replacement is full depth.
- (2) Applies to streets where asphalt pavement removal and replacement is only partial depth. See construction scope and sequencing notes on subset cover sheets for removal and replacement depth/thickness on these streets.
- (3) The Contractor may use alternative top course E mixes for Hand Patching with approval by the Engineer. LVSP is approved for use only on minor (local) streets.
- (4) HMA Approach mix shall match that used for mainline paving (top course) on the street for which the adjacent side street approaches are being paved unless otherwise approved or directed by the Engineer.

Use the respective mixes indicated above on Major and Local streets unless the plans note otherwise or directed otherwise by the Engineer. Submit mix designs and obtain approval from the Engineer for all HMA mixtures proposed for use. For approach and hand patching work on Major Streets, use the same HMA mixture respectively as specified for the top course unless otherwise approved by the Engineer.

Use 3.5% as target air void content of for leveling courses, top courses and shoulders paved in the same operation as the leveling and top courses. Use 3% as a target air void content of for base courses and shoulders not paved in the same operation as the leveling and top courses. Use 3% as a target air void content of for shared use paths.

The Performance Grade asphalt binder range for the HMA mixture shall be as noted above. Apply Bond Coat material accordance with the requirements of the Detailed Specification for HMA Paving.

Apply bond coat at a uniform rate between 0.05 and 0.10 gallons per square yard as directed and approved by the Engineer. Bond Coat is not a separate pay item; the HMA items of work for which it applies include payment for furnishing and placing bond coat.

c. Measurement and Payment. Measure and pay for this work as provided elsewhere in the contract documents.

CITY OF ANN ARBOR
DETAILED SPECIFICATION
FOR
HOT MIX ASPHALT (HMA) PAVING

AA:DAD

1 of 3

03/11/19

a. Description. This work consists of constructing hot mix asphalt (HMA) pavement base, leveling, and top courses in accordance with section 501 of the Michigan Department of Transportation (MDOT) 2012 Standard Specifications for Construction, except as modified herein, and as directed by the Engineer.

b. Materials. None specified.

c. Construction.

1. Equipment: All equipment shall conform to subsection 501.03.A of the MDOT 2012 Standard Specifications for Construction, except as modified herein.

The Contractor shall have a 10-foot long straight edge, rubber-tired backhoe (Case 580 type, or equivalent), air-compressor with the ability to develop a minimum pressure of 100 pounds per square inch and continuous rated capacity of 150 cubic feet per minute of airflow, and jackhammer available during all paving operations. The Contractor shall be required to perform any miscellaneous cleaning, trimming, material removal, and other tasks as required by the Engineer in order to ensure the proper and orderly placement of all HMA materials on this project.

The Contractor shall provide sufficient rollers to achieve the specified asphalt densities.

At various times throughout the work, the Engineer may direct the Contractor to use smaller and/or lighter equipment, and to defer certain work tasks, in order to protect the grade and/or adjacent areas; including hauling units. The Contractor shall not be entitled to any additional compensation for the use of smaller equipment, lighter equipment, or work task deferral.

2. Cleaning and Bond Coat Application: Cleaning and bond coat application shall be performed in accordance with subsections 501.03.C and 501.03.D of the MDOT 2012 Standard Specifications for Construction, except as modified herein, and as directed by the Engineer.

The Contractor shall furnish and operate throughout the construction period, vacuum-type street cleaning and utility structure cleaning equipment (Vac-All, Vector, etc.) approved by the Engineer, and when directed by the Engineer, for street cleaning immediately prior to, and for street and utility structure cleaning after any and all paving. The cleaning equipment shall be of sufficient power to remove dust, dirt, and debris from the pavement and from utility structures in and adjacent to the construction area. The Engineer shall approve the vac-all or similar equipment prior to beginning the work. The equipment used shall have an effective means for preventing any dust resulting from the operation from escaping into the air.

Apply bond coat at a rate of 0.10 gallons per square yard. Before placing the bond coat, the thoroughly clean the existing pavement surface. The Contractor shall also thoroughly clean

all joints, cracks, and edges to a minimum depth of one inch with compressed air, vac-all type equipment, or other approved mechanical or hand methods, to remove all dirt, debris, and all foreign material.

3. HMA Placement: Placement shall conform to subsection 501.03.F of the MDOT 2012 Standard Specifications for Construction, except as modified herein, and as directed by the Engineer.

HMA placement shall not commence until a "Permit to Place" (no additional costs are required to obtain this permit) has been issued in writing by the Engineer. The Engineer will issue a Permit to Place after approving the aggregate base course or the adjacent, underlying layer of pavement section.

The Engineer must approve the final structure adjustments prior to the issuance of the "Permit to Place" for the top course.

Place the top course with a ¼" lip along the edge of the curb and gutter/edge of metal.

All HMA thickness dimensions are compacted-in-place.

4. Paving Operation Scheduling: The Contractor shall schedule the paving operation to avoid leaving longitudinal cold joints "open" overnight.

In all cases, the Contractor shall pave the primary road's through-traffic lanes ("main line") first, from point-of-beginning to the point-of-ending. All other paving including, but not limited to; acceleration and deceleration lanes, intersection approaches, and center left-turn lanes shall be paved following completion of main line paving, unless authorized by the Engineer prior to the placement of any pavement.

5. Rate of Paver Operation: Maintain a paving machine rate of travel so that HMA placement and paving operation is continuous; resulting in no transverse cold joints. The rate of travel; however, shall never exceed 50 feet per minute.

The Contractor shall furnish and operate enough material, equipment, and hauling units to keep the paving machine(s) moving continuously at all times. Failure to do so shall be cause for the suspension of paving operations until the Contractor can demonstrate to the satisfaction of the Engineer that it has dedicated sufficient resources to perform the work in accordance with the project specifications.

6. Longitudinal and Transverse Joints: These joints shall conform to subsection 502.03.F of the MDOT 2012 Standard Specifications for Construction, and as specified herein.

For mainline HMA paving, the width of the mat for each pass of the paver shall be not less than 10.5 feet, or greater than 15 feet, except as noted in the plans and as directed by the Engineer. The Engineer will direct the layout of all HMA longitudinal joints during construction.

7. Feather Joints – shall be constructed so as to vary the thickness of the HMA from zero inches to the required paving thickness at the rate of approximately 1.5" over a

distance of 10 feet, or as directed by the Engineer. The Contractor shall rake the larger pieces of aggregate out of feather joints prior to compaction.

8. **Butt Joints:** Construction of butt joints, where directed by the Engineer, shall conform to subsections 501.03.C.3 and 501.03.C.4 of the MDOT 2012 Standard Specifications for Construction, except as modified herein.

When the Engineer specifies or directs placement of a butt joint, remove the existing HMA surface to the thickness of the proposed overlay, or full-depth, as directed by the Engineer, for the full width or length of the joint. The HMA material shall be saw cut to the directed depth along the pavement edge or removal line to prevent tearing of the pavement surface. Cut joints that will be exposed in the completed surface must be cut with a saw or a cold-milling machine or other methods approved by the Engineer. Joints that will be covered by HMA must be cut with a saw, a cold-milling machine, or other methods approved by the Engineer.

9. **Rakers:** The Contractor shall provide a minimum of two asphalt rakers during the placement of all wearing and leveling courses.

10. **Faulty Mixtures:** The Contractor and Engineer shall carefully observe the paving operation for signs of faulty mixtures. The Contractor, at its sole expense, shall remove or correct points of weakness in the surface prior to paving subsequent lifts of HMA material. Such corrective action may include the removal and replacement of thin or contaminated sections of pavement, segregated HMA, and any sections that are weak or unstable. Once the Contractor or his representative is notified by the Engineer that the material being placed is out of allowable tolerances, or that there is a problem with the paving operation, the Contractor shall stop the paving operation at once, and shall not be permitted to continue placing HMA material until again authorized by the Engineer. The Engineer will not pay for separately any costs associated with meeting the above requirements, and will include them in the HMA work item(s) the Contractor was performing at the time of discovery of the faulty mixture.

d. Measurement and Payment. The contract includes no separate pay items for measurement and payment of the costs associated with meeting the requirements of this detailed specification. The Contractor shall include these costs in the unit prices bid for the HMA items in the contract.

The Contractor shall return any/all trucks to the plant with unused HMA remaining after the work is complete, and these trucks shall be re-weighed and the corrected weight slip provided to the Engineer. There will no payment any unused HMA material. All weight slips must include the type of mixture (codes are not acceptable), as well as vehicle number, gross weight, tare weight and net weight.

CITY OF ANN ARBOR
 DETAILED SPECIFICATION
 FOR
HOT MIX ASHALT (HMA) PAVEMENT REPAIR

AA:DAD

1 of 1

03/23/20

a. Description. This work consists of repairing areas of failed asphalt pavement by cold milling the existing pavement and placing new hot mix asphalt (HMA) material as directed by the Engineer, and as described herein. Complete pavement repairs in the cold milled surface prior to placement of the first hot mix asphalt paving course.

b. Materials. Provide materials in accordance with subsection 501.02 of the MDOT 2012 Standard Specifications for Construction and as shown on the special detail.

c. Construction. Cold mill designated repair locations and place Hand Patching, Modified according to the details on the plans, and in accordance with subsection 501.03 of the MDOT 2012 Standard Specifications for Construction. The Engineer will designate repair locations after the pavement has been cold milled as shown on the plans. The milling machine must return to the designated repair locations to apply milling for an additional depth of 3 inches. Hand Patching, Modified must be placed in the repair area and roller compacted prior to placement of the paving course.

d. Measurement and Payment. Measure and pay for the completed work, as described, at the respective contract unit prices using the following respective pay items:

Pay Item	Pay Unit
Cold Milling HMA Surface, Modified.....	Square Yard
Hand Patching, Modified.....	Ton

Measure **Cold Milling HMA Surface, Modified** area by the unit square yard and pay for it at the contract unit price, which price includes the cost for all labor, equipment and materials required to remove, load, haul, and dispose of the cold milled material, and cleaning the cold milled pavement. The Engineer will not pay for material picked up by cleaning after cold milling.

Measure **Hand Patching, Modified** by weight in tons of the material used to perform the work and pay for it at the contract unit price, which prices includes the cost for all labor, equipment and materials to complete the work including providing, placing by hand or other methods, and compacting the HMA mixture.

Return any/all trucks to the plant with unused HMA remaining after the Hand Patching, Modified work is complete. Re-weigh these trucks and provide a weight slip for this material to the Engineer. There will be no payment for any unused HMA material. All weight slips must include the type of mixture (codes are not acceptable), as well as vehicle number, gross weight, tare weight and net weight.

CITY OF ANN ARBOR
DETAILED SPECIFICATION
FOR
HMA TRAFFIC CALMING MEASURES

AA:DAD

1 of 2

02/20/21

a. Description. This work consists of constructing traffic calming devices at locations directed by the Engineer, in accordance with the special details shown on the plans, and as described herein.

b. Materials. Provide materials in accordance with section 501 of the Michigan Department of Transportation (MDOT) 2012 Standard Specifications for Construction. Use MDOT mixture HMA, LVSP for this work, or an acceptable substitute approved by the Engineer.

c. Construction. Perform work in accordance with section 501 of the MDOT 2012 Standard Specifications for Construction, and as directed by the Engineer.

Furnish and operate all temporary traffic control devices and provide traffic regulator control necessary to complete traffic calming device construction.

Submit a temporary traffic control plan to the Engineer for approval a minimum of 48 hours in advance of this work.

Clean the existing surface with compressed air and/or vacuum type street cleaning equipment to remove dirt and debris prior to placement of HMA material. Provide compressed air from a source capable of supplying air at a minimum pressure of 90 psi and at a rate 150 cubic feet per minute of at the nozzle.

Apply MDOT SS-1h bond coat on all asphalt and concrete surfaces within the area where installing the traffic calming measure. Apply at a rate between 0.05 and 0.10 gallons/square yard using a power distributor hand sprayer. Do not place bond coat material on pavement and concrete curb and gutter surfaces adjacent to the traffic calming measures being placed that are not approved for paving.

Placing traffic calming devices using an asphalt paving machine or, where approved by the Engineer, place HMA material directly by hand. Do not place HMA materials on pavement and concrete curb and gutter surfaces adjacent to the traffic calming measures being placed that are not approved for paving.

Use City of Ann Arbor provided template when constructing traffic calming devices unless otherwise directed by the Engineer.

Construct traffic calming devices using two (2) lifts/layers of HMA material. Compact each lift of HMA mixture to between 92 and 96 percent (or as determined acceptable by the Engineer) of the theoretical maximum density, as listed on the approved Job Mix Formula.

Provide a 10-foot long straight-edge and a 10-foot long level during all paving operations.

Place temporary pavement markings to delineate and differentiate the traffic calming devices for traffic as directed by the Engineer.

Place permanent pavement markings as required and in accordance with the special details on the plans and as directed by the Engineer.

d. Measurement and Payment. Measure and pay for the completed work, as described, at the contract unit price using the following pay items:

<u>Pay Item</u>	<u>Pay Unit</u>
Raised Crosswalk, HMA	Square Yard
Raised Intersection, HMA	Square Yard
Speed Hump, HMA	Square Yard
Speed Table, HMA.....	Square Yard

Measure **Raised Crosswalk, HMA; Raised Intersection, HMA; Speed Hump, HMA; and Speed Table, HMA** areas in place by the unit square yard and pay for them at their respective contract unit prices, which prices include the costs for all labor, equipment and materials necessary to complete the work including providing, placing and compacting the HMA mixture.

Measure and pay for separately temporary traffic control devices and traffic regulator control.

Measure and pay for separately temporary and permanent pavement markings.

CITY OF ANN ARBOR
DETAILED SPECIFICATION
FOR
HMA, WEDGING, 36A

AA:DAD

1 of 1

03/23/20

a. Description. This work consists of constructing hot mix asphalt (HMA) finish wedges at drive approaches, sidewalk ramps, and any other location(s) directed by the Engineer, and as described herein.

b. Materials. Provide materials in accordance with section 501 of the Michigan Department of Transportation (MDOT) 2012 Standard Specifications for Construction. Use MDOT mixture HMA, 36A for this work, or an acceptable substitute approved by the Engineer.

c. Construction. Perform work in accordance with section 501 of the MDOT 2012 Standard Specifications for Construction, and as directed by the Engineer.

Complete all finish wedging within two days of placing the top course pavement.

Have a 10-foot long straight-edge, backhoe, air-compressor and jackhammer available during all paving operations.

Use finish wedges to provide good vertical and horizontal transitions between old and new construction, to eliminate areas of standing water in the top coarse surface and to provide for positive drainage.

Construct joints by feathering the edges of all finish wedges (including the raking out of all large pieces of aggregate) to provide a high quality, smooth riding surface.

Clean the existing surface with compressed air and/or vacuum type street cleaning equipment prior to placement of wedging material.

Apply MDOT SS-1h bond coat on all asphalt and concrete surfaces within the wedging area at a rate between 0.05 and 0.10 gallons/square yard using a power distributor hand sprayer.

d. Measurement and Payment. Measure and pay for the completed work, as described, at the contract unit price for the following pay item:

<u>Pay Item</u>	<u>Pay Unit</u>
HMA, Wedging, 36A.....	Ton

Measure **HMA, Wedging, 36A** by weight in tons of the material used to perform the work and pay for it at the contract unit price, which price includes all cost for labor, equipment and materials necessary to complete the work including providing, placing and compacting the HMA mixture.

Return any/all trucks to the plant with unused HMA remaining after the work is complete. Re-weigh these trucks and provide a weight slip for this material to the Engineer. There will be no payment for any unused HMA material. All weight slips must include the type of mixture (codes are not acceptable), as well as vehicle number, gross weight, tare weight and net weight.

CITY OF ANN ARBOR

DETAILED SPECIFICATION
FOR

REMOVING HOT MIX ASPHALT AROUND STRUCTURE COVERS

AA:DAD

1 of 1

02/25/18

a. Description. This work consists of removing hot mix asphalt (HMA) from around existing (not lowered) structure covers during the cold milling operations as required, whether structures are shown or not shown on the plans, and as herein provided. Covers include those used for storm, sanitary, and water structures, gate and monument boxes, and other private utility structures.

This item does not apply to locations (streets) where structures have been temporary lowered in advance of the cold milling operations.

b. Materials. None specified.

c. Construction. Remove HMA surface adjacent to structure covers to the same depth as the cold milled surface without the removal of the aggregate or concrete base. Complete work in accordance with subsections 204.03 and 501.03 of the Michigan Department of Transportation (MDOT) 2012 Standard Specifications for Construction, and as directed by the Engineer.

Remove HMA surface, any thickness, from around existing structure covers using a milling machine, and/or hand tools, or other means as approved by the Engineer. Repair or replacement of any structure covers damaged during this operation is the sole responsibility of the Contractor.

d. Measurement and Payment. Measure and pay for the completed work, as described, at the contract unit price for the following pay item:

<u>Pay Item</u>	<u>Pay Unit</u>
HMA Surface, Around Structure Cover, Rem.....	Each

Measure **HMA Surface, Around Structure Cover, Rem** individually in place by the unit each and pay for it at the contract unit price, which price includes all cost for labor, equipment and materials necessary to complete the work.

The number of castings within the milling limits shall constitute the final amount. Measurement shall take place with both the Engineer and the Contractor (or their agents) present.

CITY OF ANN ARBOR
DETAILED SPECIFICATION
FOR
CONCRETE PLACEMENT AND PROTECTION

AA:DAD

1 of 2

02/28/19

a. Description. This work consists of furnishing all labor, material, and equipment necessary to furnish, place, and protect all concrete material in accordance with the Michigan Department of Transportation (MDOT) 2012 Standard Specifications for Construction and the requirements of this detailed specification. These requirements do not apply to concrete bridge decks, unless otherwise noted.

b. Materials. Use concrete meeting the requirements of sections 601 and 701 of the Michigan Department of Transportation (MDOT) 2012 Standard Specifications for Construction.

Propose specific concrete mix designs for the intended project purpose in accordance with the requirements of this detailed specification and other applicable detailed specifications and/or project requirements. The Engineer's acceptance of a mix design does not relieve the Contractor of its responsibility for the manufacture of the concrete mixture(s), the placement, or performance.

c. Construction. Perform all concrete placement operations in weather that is suitable for the successful placement and curing of the concrete materials. Do not place concrete during periods of active precipitation.

Complete all necessary formwork, base and/or sub-base preparation, and any other related items deemed necessary for the proper completion of the work. Do not commence with placement of concrete until the Engineer provides all needed approvals for placement. The Engineer's approval of the Contractor to place concrete shall not relieve the Contractor of its responsibility for the proper placement and protection of the concrete materials or its long-term performance.

During periods when precipitation is threatening, provide durable, plastic sheeting, approved by the Engineer, in sufficient quantity to cover and protect all freshly placed concrete and keep it from exposed to any precipitation. Arrange the placement of the plastic sheeting such that it does not mar the surface of any freshly placed concrete, and any/all seams in the plastic sheeting are watertight. Install adequate supports along and over the freshly placed concrete to prevent any contact between it and the plastic sheeting. Ensure placement of sufficient dams or barriers along the edges of freshly placed concrete to prevent erosion of the underlying materials or damage to the edges. All measures shall be effective.

Remove and replace any concrete damaged by precipitation. The Engineer will determine the extent of any damage and the limits of removal and replacement.

Place concrete only when the rate of surface evaporation at the site is less than 0.20 pounds per square foot per hour, according to figure 706-1 of the MDOT 2012 Standard Specifications for Construction. Provide approved equipment for determining the relative humidity and wind velocity at the site.

Perform the addition of water at the placement site in accordance with subsection 601.03.E.4 of the MDOT 2012 Standard Specifications for Construction. Do not add water to placed concrete in order to aid finishing.

Perform concrete curing in accordance with subsection 602.03.M of the MDOT 2012 Standard Specifications for Construction. Curing operations will take precedence over texturing operations and continued concrete placement. Apply curing compound to achieve uniform coverage over the entire surface. Place curing compound so that it is free of spots, blotches, and/or uncovered or non-uniformly covered areas. Should the Engineer determine that any such areas exist, it will direct the Contractor to re-apply curing compound immediately at no additional cost to the project.

Take all precautions when placing concrete to protect it from damage due to the elements. Do not place concrete during precipitation events.

Protect concrete from weather and temperature according to the requirements of subsection 602.03.T of the MDOT 2012 Standard Specifications for Construction. Do not place concrete when the temperature of the plastic concrete mixture is greater than 90° F. Cover concrete with insulated blankets, or using other means approved by the Engineer, to protect it from damage during low temperature conditions. Protect concrete until it has reached a compressive strength of at least 1000 psi, or as directed by the Engineer.

d. Measurement and Payment. The contract includes no separate pay items for measurement and payment of the costs associated with meeting the requirements of this detailed specification. Include these costs in the unit price bids for the concrete items in the contract.

Removal and replacement, as determined and directed by the Engineer, of any concrete damaged by precipitation or cold weather is at the expense of the Contractor.

CITY OF ANN ARBOR
 DETAILED SPECIFICATION
 FOR
FLOWABLE FILL

AA:DAD

1 of 2

02/24/18

a. Description. This work consists of furnishing and placing flowable fill material as backfill between new and/or replacement curb and gutter and the existing pavement and at other miscellaneous locations as shown on the plans, and as directed by the Engineer.

b. Materials. Provide flowable fill material, as directed by the Engineer, meeting one the following mixes:

1. Portland cement, fly ash, and water.
2. Portland cement, granular material, fly ash, and water.
3. Fly ash, granular material, and water.

Provide materials in accordance with the following requirements:

		⁽³⁾ <u>Specific Gravity</u>
Portland Cement	MDOT Section 901	3.15
Fly Ash	⁽¹⁾ ASTM C 618(I)	2.40
Granular Material, CI II	⁽²⁾ MDOT Section 902	2.60
Water	MDOT Section 911	1.00

Note: Reference to MDOT relates to applicable sections of the Michigan Department of Transportation 2012 Standard Specifications for Construction.

⁽¹⁾Except there is no limit on the loss of ignition.

⁽²⁾Except that 100% shall pass 3/4-inch sieve.

⁽³⁾Specific gravity values used for mix proportions given. If material used differs from these values make appropriate adjustments as required to achieve an acceptable mixture.

Acceptable mixtures for flowable fill are as follows:

1. FF Mix Number One - Cement Stabilized Fly Ash Mixture (Class F Fly Ash)

Portland Cement	100 lbs/cyd
Fly Ash (Class F)	2000 lbs/cyd
Water	Sufficient amounts to produce the desired flowability (approx. 80 gal/cyd)

2. FF Mix Number Two - Controlled Density Fill Mixture (Class F Fly Ash)

Portland Cement	50 lbs/cyd
Fly Ash (Class F)	500 lbs/cyd
Granular Material	2600 lbs/cyd
Water	Sufficient amounts to produce the desired flowability (approx. 50 gal/cyd)

3. FF Mix Number Three - Controlled Density Fill Mixture (Class C Fly Ash)

Fly Ash (Class C)	300 lbs/cyd
Granular Material	2600 lbs/cyd
Water	Sufficient amounts to produce the desired flowability (approx. 50 gal/cyd)

c. Construction. Furnish and place flowable fill material as directed by the Engineer.

The Contractor shall provide all necessary materials and appurtenances to ensure proper placement of flowable fill. All flowable fill, after setting, should be capable of removal by conventional mechanical excavation methods.

d. Measurement and Payment. Measure and pay for the completed work, as described, at the contract unit price for the following pay item:

<u>Pay Item</u>	<u>Pay Unit</u>
Flowable Fill	Cubic Yard

Measure **Flowable Fill** volume in place by the unit cubic yard and pay for it at the contract unit price, which price includes the cost for all labor, equipment and materials necessary to complete the work.

The Engineer will not pay for any flowable fill used at the Contractor's option.

CITY OF ANN ARBOR
 DETAILED SPECIFICATION
 FOR
CONCRETE CURB AND GUTTER, AND DRIVEWAY OPENINGS

AA:DAD

1 of 2

03/11/19

a. Description. This work consists of constructing concrete curb and gutter, and concrete driveway openings at the locations shown on the plans in accordance with section 802 of the Michigan Department of Transportation (MDOT) 2012 Standard Specifications for Construction, applicable standard or special details, as directed by the Engineer, and as specified herein.

b. Materials. Provide materials meeting the requirements specified in subsection 802.02 of the MDOT 2012 Standard Specifications for Construction and as specified herein.

Use concrete mixture Grade P-NC (658 pounds/cubic yard cement content) for Driveway Opening, Conc, Det M, Modified as specified in subsection 601.02 of the MDOT 2012 Standard Specifications.

Use either Grade P1 or S2 concrete for all other concrete curb and gutter specified herein. The Contractor may elect to add GGBFS to P1 mixtures in accordance with the requirements of the contract documents. The Engineer will not pay any additional amount for concrete mixtures containing GGBFS.

Provide concrete mixtures containing 6AA coarse aggregates that are either natural or limestone and meet the requirements of section 902 the MDOT 2012 Standard Specifications for Construction.

The Contractor is solely responsibility for providing specific concrete mix designs that meet the requirements of this detailed specification.

c. Construction. Use construction methods in accordance with subsection 802.03 of the MDOT 2012 Standard Specifications for Construction.

Place expansion joints of the thickness shown on the details or as directed by the Engineer.

d. Measurement and Payment. Measure and pay for the completed work, as described, at the respective contract unit prices using the following respective pay items:

<u>Pay Item</u>	<u>Pay Unit</u>
Curb and Gutter, Conc, Barrier.....	Foot
Curb and Gutter, Conc, Mountable	Foot
Driveway Opening, Conc, Det M, Modified	Foot

Measure **Curb and Gutter, Conc** and **Driveway Opening, Conc, Det M, Modified** lengths in place by the unit foot and pay for them at their respective contract unit prices, which prices include the costs for all labor, equipment and materials to complete the work.

Measurement in place by the unit foot and payment for concrete curb and gutter (without the curb face) at curb openings for sidewalk ramps will be at the contact unit price for **Curb and Gutter, Conc.**

Where the Engineer directs the use of high early strength concrete for pay items not specifically designated to use Grade P-NC concrete, it will pay separately for the additional cement. The Engineer will not pay for cement separately for pay items that designated to use Grade P-NC concrete.

CITY OF ANN ARBOR
DETAILED SPECIFICATION
FOR
DETECTABLE WARNING SURFACE

AA:DAD

1 of 2

03/11/19

a. Description. This work consists of furnishing and installing cast in place detectable warning units in compliance to the Americans with Disabilities Act (ADA) Title 49 CFR Transportation, Part 37.9 Standards for Accessible Transportation Facilities, Appendix A, section 4.29.2 Detectable Warnings on Walking Surfaces. Complete work in accordance with the Detailed Specification for “Concrete Sidewalk, Sidewalk Ramps, and Driveway Approach”, section 803 of the Michigan Department of Transportation (MODT) 2012 Standard Specifications for Construction, MDOT Standard Plan Series R-28, as indicated on the plans, and as modified herein.

b. Materials. Use color Federal Number 22144 (frequently referred to as “Colonial Red” or “Brick Red”) for detectable warning tiles.

The following apply to this detailed specification: American Society for Testing and Materials (ASTM) Test Methods B117, C1028, D543, D570, D638, D695, D790, D2486, D2565, D5420, and E84.

Provide detectable warning tiles meeting the following material properties, dimensions, and tolerances using the most current test methods:

1. Water Absorption: Not to exceed 0.35% when tested in accordance with ASTM-D570
2. Slip Resistance: 0.80 minimum combined wet/dry static coefficient of friction on top domes and field area, when tested in accordance with ASTM C1028.
3. Compressive Strength: 18,000 psi minimum, when tested in accordance with ASTM D695.
4. Tensile Strength: 10,000 psi minimum, when tested in accordance with ASTM D638.
5. Flexural Strength: 24,000 psi minimum, when tested in accordance with ASTM D790.
6. Chemical Stain Resistance: No reaction to 1% hydrochloric acid, urine, chewing gum, soap solution, motor oil, bleach, calcium chloride, when tested in accordance with ASTM D543 or D1308.
7. Wear Depth: 300 minimum, when tested in accordance with ASTM C501.
8. Flame Spread: 25 maximum, when tested in accordance with ASTM E84.
9. Gardner Impact: 50 in.-lbs. minimum, when tested in accordance with Geometry “GE” of ASTM D5420.
10. Accelerated Weathering of Tile when tested by ASTM-G155 or ASTM G151 shall exhibit the following result- $\Delta E < 6.0$ as well as no deterioration, fading or chalking of surface when exposed to 3000 hours minimum exposure.
11. Wheel Loading: The cast in place tile shall be mounted on a concrete platform with a 1/2” airspace at the underside of the tile top plate then subjected to the specified maximum load of 10,400 lbs., corresponding to an 8,000 lb individual wheel load and a 30% impact factor. The tile shall exhibit no visible damage at the maximum load of 10,400 lbs using AASHTO-HB17 single sheet HS20-44 loading “Standard Specifications for Highways and Bridges.”

12. Salt and Spray Performance of Tile and Adhesive System when tested to ASTM-B117 not to show any deterioration or other defects after 100 hours of exposure

Submit manufacturer’s literature describing products, installation procedures and maintenance instructions. Provide cast-in-place detectable surface tiles and accessories as produced by a single manufacturer.

Samples for Verification Purposes: Submit two (2) tile samples minimum 6” x 8” of the kind proposed for use. Properly label samples to show the following information: Name of Project; Submitted by; Date of Submittal; Manufacture’s Name; Catalog No.; and Date of Fabrication.

Material Test Reports: Submit current test reports from a qualified, independent, testing laboratory that verify materials proposed for use comply with requirements of this detailed specification. Use a certified and qualified independent testing laboratory to perform any/all other tests required by this detailed specification to ensure the proposed cast-in-place tactile warning system is compliant. All test reports submitted shall be certified by the testing laboratory and shall clearly state that all tests were completed within 5 years of the date of the submittal. The manufacturer shall certify in writing that the materials provided to the project are manufactured with the same materials and manufacturing procedures as those used in the materials on which the tests were performed.

c. Construction. Installer Qualifications: Engage an experienced installer who has successfully completed tile installations similar in material, design, and extent required for this project.

Follow manufacturer specifications for installation, except where they conflict with MDOT Standard Plan Series R-28, or other project requirements.

d. Measurement and Payment. Measure and pay for the completed work, as described, at the respective contract unit prices using the following respective pay items:

<u>Pay Item</u>	<u>Pay Unit</u>
Detectable Warning Surface, Modified.....	Foot

Measure **Detectable Warning Surface, Modified** length in place by the unit foot and pay for it at the contract unit price, which price includes the costs for all labor, equipment and materials to complete the work.

CITY OF ANN ARBOR
DETAILED SPECIFICATION
FOR
SIDEWALK RETAINING WALLS

AA:DAD

1 of 4

02/26/18

a. Description. This work consists of constructing concrete retaining walls adjacent to sidewalks in accordance with the requirements and special details included herein, and as directed by the Engineer.

b. Materials. Provide concrete Grade P-NC, unless otherwise directed by the Engineer, meeting the requirements of subsection 602.03 of the Michigan Department of Transportation (MDOT) 2012 Standard Specifications for Construction.

c. Construction. Construct retaining walls in accordance with special details included herein. Curb face exposure shall be 6 inches to 36 inches.

The Contractor shall excavate, cut, remove stumps, remove brush, remove pavement, grade, and trim as needed and as directed, and shall furnish, place, grade, and compact any materials needed to perform the work.

Complete all subgrade work prior to placing concrete items, unless directed or approved by the Engineer.

At locations where the subgrade, subbase or base becomes either disturbed, saturated or otherwise damaged, and where directed by the Engineer, the Contractor shall remove a minimum 6-inch thick layer of the subgrade, subbase or base, and replace it with approved 21AA Aggregate material, compacted in place.

The Contractor shall coordinate with the City Forester prior to the removal of any tree roots 2 inches in diameter or greater.

The Contractor shall maintain on-site at all times, a sufficient quantity of adequate materials to protect concrete items. The Engineer may suspend or defer concrete placement if rain protection is not available. The Contractor shall not be entitled to any additional compensation due to work suspension or deferral resulting from a lack of adequate rain protection.

The Contractor is responsible for any damage to concrete items, including but not limited to vandalism; vehicular, pedestrian and/or miscellaneous structural damage; surface texture damage; and rain damage.

d. Measurement and Payment. Measure and pay for the completed work, as described, at the contract unit price using the following pay items:

<u>Pay Item</u>	<u>Pay Unit</u>
Sidewalk Retaining Wall, Integral, 6 inch to 18 inch Height	Square Foot
Sidewalk Retaining Wall, Integral, 18 inch to 30 inch Height	Square Foot

Measure **Sidewalk Retaining Wall, Integral, __ inch to __ inch Height** exposed vertical face

areas in place by the unit square foot and pay for them at their respective contract unit prices, which prices include the costs for all labor, equipment and materials necessary to complete the work.

The Engineer will pay for separately all sidewalk work performed adjacent to any retaining wall.

INTEGRAL SIDEWALK RETAINING WALL (6" - 18") DETAIL

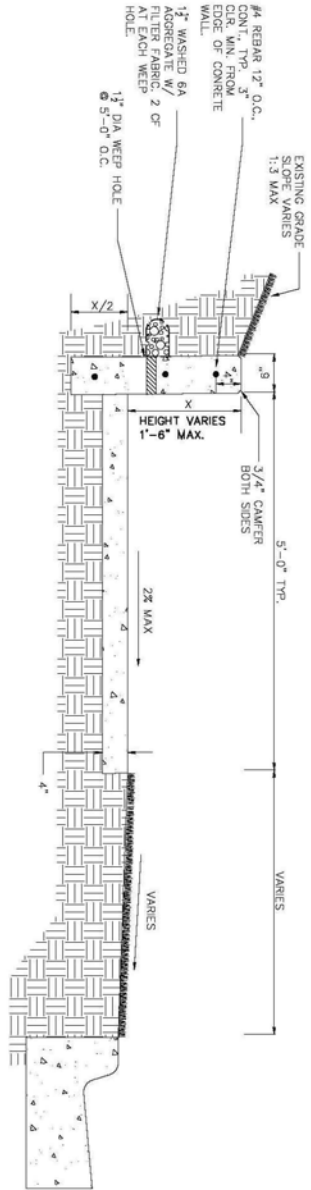

INTEGRAL SIDEWALK RETAINING WALL (18"-36") DETAIL

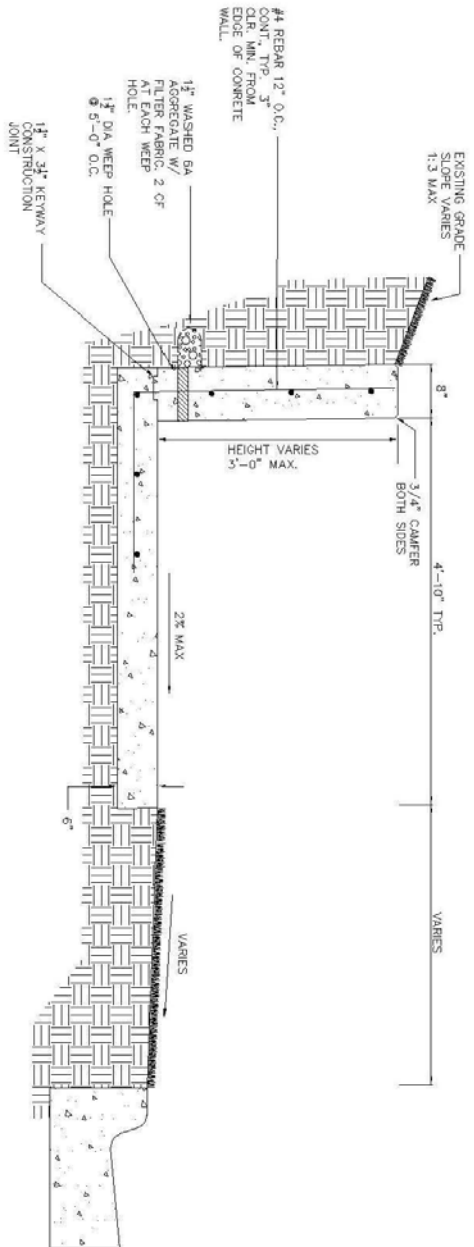

CITY OF ANN ARBOR
DETAILED SPECIFICATION
FOR
REMOVAL AND REINSTALLATION OF CONCRETE OR CLAY BRICK PAVERS

AA:DAD

1 of 2

03/11/19

a. Description. This work consists of removing, stockpiling and reinstalling concrete, clay, or other type material, brick sidewalk pavers. Furnish and install sand base, concrete base, fine aggregate leveling bed, fine aggregate joint filler, and any additional brick pavers as shown on the plans, and as directed by the Engineer.

b. Materials. Provide base material, where required, meeting requirements for Class 21AA of dense-graded aggregate in accordance with section 902 of the Michigan Department of Transportation (MDOT) 2012 Standard Specifications for Construction and the Detailed Specification for Aggregate Base. Provide subbase material, where required, meeting requirements for Class II granular material in accordance with section 902 of the MDOT 2012 Standard Specifications for Construction.

Construct concrete base, where required, using Grade P1 or Grade P2 concrete in accordance with section 601 of the MDOT 2012 Standard Specifications for Construction.

Construct a fine aggregate leveling bed shall consisting of a 3:1 mix of 2NS fine aggregate (3 parts) and Type N masonry cement (1 part). Use 2MS fine aggregate as joint filler. Provide masonry cement and fine aggregate materials in accordance with sections 901 and 902, respectively, of the MDOT 2012 Standard Specifications for Construction.

Use additional brick pavers as required matching the material and color of the existing brick pavers in the areas adjoining the removal/replacement limits.

c. Construction. Remove and salvage existing pavers, remove any existing mortar or bituminous setting bed and concrete base, to the limits specified by the Engineer, down to the existing aggregate base. Where an existing base is not present, remove the subbase to a sufficient depth for construction of the proposed section as shown on the attached detail, or as directed by the Engineer. Store and protect salvaged pavers on-site in an area approved by the Engineer until they are ready for use.

Shape, grade, and compact the existing base materials, and construct the base to match the existing adjacent elevations.

Blend fine aggregate and mortar uniformly to create the leveling bed mix. Place leveling bed on aggregate base or existing concrete base to the depth shown on the Plans. Use control bars and/or guides to screed the fine aggregate leveling bed.

Match new/reinstalled brick pattern with that of the existing adjacent brickwork. Use string lines or other devices as necessary to insure straight joint lines and final surface elevations. Butt paving units tight to adjacent concrete paving and to each other. Protect newly laid pavers at all times by plywood panels on which workers stand. Use a plate vibratory compactor (minimum of 5,000lbs compaction force) and make a minimum of three (3) passes to set paving units in leveling course prior to filling joints. Protect pavers from chipping and cracking during compaction.

Spread fine aggregate joint filler over paver surface and broom into joints, and mist lightly with water to settle sand into joints. Allow to surface dry and repeat process, as required, to fill joints

completely. Remove excess sand upon completion.

Take any necessary precautions to prevent damage or theft to pavers during removal, salvage, and replacement. The Engineer will not pay additional compensation for the replacement of damaged or stolen pavers.

d. Measurement and Payment. Measure and pay for the completed work, as described, at the contract unit price using the following pay item:

Pay Item

Pay Unit

Sidewalk, Conc or Clay Brick Pavers, Rem and Reinstall..... Square Foot

Measure **Sidewalk, Conc or Clay Brick Pavers, Rem and Reinstall** area in place by the unit square foot and pay for it at the contract unit price, which price includes all cost for labor, equipment and materials necessary to complete the work.

CITY OF ANN ARBOR
DETAILED SPECIFICATION
FOR
CONCRETE SIDEWALK, SIDEWALK RAMP AND DRIVEWAY APPROACH

AA:DAD

1 of 2

03/11/19

a. Description. This work consists of constructing concrete sidewalks, sidewalk ramps, or driveway approaches of the types as indicated on the plans in accordance with attached details, and as directed by the Engineer. All work shall be in accordance with sections 801 and/or 803 of the Michigan Department of Transportation (MDOT) 2012 Standard Specifications for Construction, and as specified herein.

b. Materials. Provided materials meeting the requirements specified subsections 801.02 and/or 803.02 of the MDOT 2012 Standard Specifications for Construction and as specified herein.

Use concrete mixture Grade P-NC (658 pounds/cubic yard cement content) for driveway approaches as specified in subsection 601.02 of the MDOT 2012 Standard Specifications.

Use either Grade P1 or S2 concrete for all remaining items covered by this detailed specification. The Contractor may elect to add GGBFS to P1 mixtures in accordance with the requirements of the contract documents. The Engineer will not pay any additional amount for concrete mixtures containing GGBFS.

Provide concrete mixtures containing 6AA coarse aggregates that are either natural or limestone and meet the requirements of section 902 the MDOT 2012 Standard Specifications for Construction.

The Contractor is solely responsibility for providing specific concrete mix designs that meet the requirements of this detailed specification.

c. Construction Methods. Perform this work in accordance with subsections 801.03 and/or 803.03 of the MDOT 2012 Standard Specifications for Construction and as required herein. The Contractor is responsible to construct all sidewalks, sidewalk ramps, curbs, and all other concrete items within ADAAG and PROWAG compliance. Construct all sidewalk ramps in accordance with MDOT Standard Plan Series R-28.

Place any/all concrete on a minimum of 4 inches of Granular Material Class II compacted to 95% of its maximum dry density unless otherwise directed by the Engineer.

Prior to placing any concrete, the compact and trim the subgrade to the final elevation. If a cold joint is required, clean existing concrete with compressed air to expose the aggregate in the concrete.

Where indicated on the plans, horizontally saw cut curbs to provide openings for sidewalk ramps. The Engineer will define the extent of the saw cuts both horizontally and vertically.

Install all sidewalk ramps with detectable warning tiles. Reference the Detailed Specification for Detectable Warning Surface for additional requirements.

d. Measurement and Payment. Measure and pay for the completed work, as described, at the respective contract unit prices using the following respective pay items:

<u>Pay Item</u>	<u>Pay Unit</u>
Driveway, Nonreinf Conc, 6 inch, Modified	Square Yard
Driveway, Nonreinf Conc, 8 inch, Modified	Square Yard
Sidewalk, Conc, 4 inch, Modified	Square Foot
Sidewalk, Conc, 6 inch, Modified	Square Foot
Sidewalk, Conc, 8 inch, Modified	Square Foot
Sidewalk Ramp, Conc, 6 inch, Modified.....	Square Foot
Sidewalk Ramp, Conc, 8 inch, Modified.....	Square Foot

Measure **Driveway, Nonreinf Conc, _ inch, Modified** areas in place by the unit square yard and pay for them at their respective contract unit prices, which prices include the costs for all labor, equipment and materials to complete the work.

Measure **Sidewalk, Conc, _ inch, Modified** and **Sidewalk Ramp, Conc, _ inch, Modified** areas in place by the unit square foot and pay for them at their respective contract unit prices, which prices include the costs for all labor, equipment and materials to complete the work.

Saw cutting is not a separate contract pay item, and payment for this work will be included in the appropriate item of work for which it applies. The Contractor shall include any/all costs for saw cutting to place concrete driveways, sidewalk and sidewalk ramps in the respective contract unit prices bid for **Driveway, Nonreinf Conc, _ inch, Modified; Sidewalk, Conc, _ inch, Modified; and Sidewalk Ramp, Conc, _ inch, Modified.**

Where the Engineer directs the use of high early strength concrete for pay items not specifically designated to use Grade P-NC concrete, it will separately for the additional cement. The Engineer will not pay for cement separately for pay items that designated to use Grade P-NC concrete.

The pay items, **Granular Material Class II** and **Subbase, CIP**, are for the furnishing, placement, grading and compaction of bedding material respectively beneath replacement and new sidewalks and sidewalk ramps.

The pay items for **Grading, Driveway Approach; Grading, Sidewalk;** and **Grading, Sidewalk Ramp** respectively include earth excavation, furnishing and placement of embankment material, and preparing the grade for placement of Aggregate Base, Granular Material Class II or Subbase, CIP bedding material beneath replacement and new sidewalks and sidewalk ramps.

Measurement in place by the unit foot and payment for detectable warning tiles in sidewalk ramps will be at the contact unit price for **Detectable Warning Surface, Modified** in accordance with the Detailed Specification for Detectable Warning Surface.

CITY OF ANN ARBOR
 DETAILED SPECIFICATION
 FOR
SHARED USE PATH GRADING

AA:DAD

1 of 2

03/23/20

a. Description. This work consists of removing miscellaneous structures and materials, and completing all earthwork required to construct new and replacement asphalt paths to the lines and grades shown on the plans and/or as directed by the Engineer. Complete this work according to sections 205 and 806 Michigan Department of Transportation (MDOT) 2012 Standard Specifications for Construction, this detailed specification, and as directed by the Engineer.

b. Materials. Provide Granular Material Class II and 21AA dense-graded aggregate materials in accordance with those specified in section 902 of the MDOT 2012 Standard Specifications for Construction as necessary to achieve the required cross section(s). The Contractor may use excavated material, if suitable, as embankment with approval by the Engineer.

c. Construction. Complete this work, as applicable, according to subsections 205.03 and 806.03 of the MDOT 2012 Standard Specifications for Construction. Grading for shared use path includes, but is not limited to, the following work:

1. Stripping and stockpiling topsoil for use in turf establishment as approved.
2. Removing rocks or boulders less than 0.5 cubic yards in volume.
3. Excavating material to a depth necessary for construction.
4. Required brushing and tree trimming and removal of materials resulting from this work.
5. Removing and disposing of overburden vegetation and soils alongside the existing pathway edges prior to any crushing and shaping activities.
6. Disposing of excess and unsuitable material according to section 205 of the MDOT 2012 Standards Specifications for Construction.
7. Shaping, grading, and compacting the subgrade to proposed grades to prepare it for embankment or aggregate base bedding material.
8. Furnishing and placing embankment material to the grades necessary for construction.
9. Shaping, grading, and compacting embankment to proposed grades to prepare it for aggregate base bedding material.
10. Matching new shared use path grades with existing or new grades as required.

d. Measurement and Payment. Measure and pay for the completed work, as described, at the contract unit price using the following pay items:

<u>Pay Item</u>	<u>Pay Unit</u>
Shared use Path, Grading, Modified	Square Yard

Measure **Shared use Path, Grading, Modified** area in place by the unit square yard and pay for it at the contract unit price, which price includes the costs for all labor, equipment and materials necessary to complete the work.

CITY OF ANN ARBOR
 DETIALED SPECIFICATION
 FOR
HOT MIX ASPHALT (HMA) SHARED USE PATH WEDGING

AA:DAD

1 of 2

03/23/20

a. Description. This work consists of constructing hot mix asphalt (HMA) wedging along shared use paths as directed by the Engineer, and as described herein.

b. Materials. Provide materials in accordance with section 501 of the Michigan Department of Transportation (MDOT) 2012 Standard Specifications for Construction. Use HMA mixture shown in the Detailed Specification for Hot Mix Asphalt (HMA) Application Estimate included in the contract for this work, or an acceptable substitute approved by the Engineer.

c. Construction. Perform work in accordance with section 501 of the MDOT 2012 Standard Specifications for Construction, and as directed by the Engineer.

Place wedging material in accordance with the application rate shown in the Detailed Specification for Hot Mix Asphalt (HMA) Application Estimate included in the contract.

Have a 10-foot long straight-edge, backhoe, air-compressor and jackhammer available during all paving operations for wedging work.

Use wedging to provide good vertical and horizontal transitions between old and new construction, eliminate areas of standing water in the wearing surface and provide for positive drainage, and to perform cross slope correction to achieve compliance with current standards.

Construct joints by feathering the edges of all wedging (including the raking out of all large pieces of aggregate) to provide a high quality, smooth riding surface.

Clean the existing surface with compressed air and/or vacuum type street cleaning equipment prior to placement of wedging material.

Apply MDOT SS-1h bond coat on all asphalt and concrete surfaces within the wedging area at a rate between 0.05 and 0.10 gallons/square yard as directed by the Engineer using a power distributor hand sprayer.

d. Measurement and Payment. Measure and pay for the completed work, as described, at the contract unit price for the following pay item:

<u>Pay Item</u>	<u>Pay Unit</u>
Shared use Path, HMA, Wedging	Ton

Measure **Shared use Path, HMA, Wedging** by weight in tons of the material used to perform the work and pay for it at the contract unit price, which price includes all cost for labor, equipment and materials necessary to complete the work including providing, placing and compacting the HMA mixture.

Return any/all trucks to the plant with unused HMA remaining after the work is complete, and re-weigh these trucks to obtain an accurate quantity of unused/waste material. Provide to the Engineer, a corrected or new weight ticket/slip that accounts for the unused material. There will be no payment for any unused HMA material. All weight tickets/slips must include the type of mixture (codes are not acceptable), as well as vehicle number, gross weight, tare weight, and net weight.

CITY OF ANN ARBOR
DETAILED SPECIFICATION
FOR
FENCE, PROTECTIVE, MODIFIED

AA:DAD

1 of 2

03/11/19

a. Description. This work consists of taking all reasonable measures to protect all existing trees and vegetation designated for protection within the project limits and the construction influence area, in accordance with subsection 201.03.A.2 and section 808 of the Michigan Department of Transportation (MDOT) 2012 Standard Specifications for Construction, as directed by the Engineer, and as specified herein. The work also consists of installing protective fencing at the limits of the construction area as shown on the plans or in areas directed by the Engineer.

b. Materials. Use orange, vinyl, snow fence fabric material, 4 feet tall. Use 6 foot long, T-shaped, metal posts or 2-inch square hardwood stakes.

c. Construction. Install protective fence at the limits of the construction area as shown on the plans or as directed by the Engineer.

Do not operate equipment within or beyond in any area(s) bounded by protection fence without the approval of the Engineer.

Do not stockpile or store construction material, supplies, and/or equipment within or beyond in any area(s) bounded by protection fence

The Engineer will not permit any vehicles and/or personnel within or beyond in any area(s) bounded by protection fence

Attach no chains, cables, ropes, nails, or other articles to any tree at any time.

Prune tree roots 1-1/2 inch or greater in diameter exposed during construction. The Engineer shall review and approve all pruning operations. Perform all root pruning with sharp tools and provide clean cuts so not damage the remaining bark or root. The Contractor shall not perform any backfilling operations until all root maintenance work is complete.

The City Forester or an approved forestry specialist will direct the repair(s) to any damaged to trees owned by the City of Ann Arbor or other trees designated for protection.

Damage to plant roots caused by Contractor operations to the extent the plant requires removal will result in one of the following actions:

1. The Contractor will replace the plant with a commensurate number of plants, 2½" caliper trees of the species as determined by the City.
2. Compensate the City of Ann Arbor for the cash value of the plant or tree as determined by the City of Ann Arbor's Forester.

The City of Ann Arbor is solely responsible for determining the corrective action and directing the Contractor as to which of above will be acceptable.

The City Forester will supervise the replacement of any trees.

Remove protection fence when directed by the Engineer.

d. Measurement and Payment. Measure and pay for the completed work, as described, at the contract unit price using the following pay item:

<u>Pay Item</u>	<u>Pay Unit</u>
Fence, Protective, Modified.....	Foot

Measure **Fence, Protective, Modified** length in place by the unit foot and pay for it at the contract unit price, which price includes all cost for labor, equipment and materials necessary to complete the work. The contract unit price also includes payment for any/all cost related to fence maintenance, and reinstallation as required, during the construction period.

The Contractor is solely responsible for any/all repair or replacement costs associated with damage to existing trees and vegetation caused by its construction activities and/or operations.

CITY OF ANN ARBOR
 DETAILED SPECIFICATION
 FOR
PERMANENT PAVEMENT MARKINGS

AA:DAD

1 of 1

02/24/18

a. Description. This work consists of providing and placing permanent pavement markings in accordance with the Michigan Manual on Uniform Traffic Control Devices (MMUTCD). Provide pavement markings that conform to the plans, section 811 of the Michigan Department of Transportation (MDOT) 2012 Standard Specifications for Construction, MDOT Pavement Marking Standard Plans, City of Ann Arbor Special Details, as directed by the Engineer, and as specified herein.

b. Materials. Provide materials in accordance with sections 811 and 920 of the MDOT 2012 Standard Specifications for Construction. Provide the Material Safety Data Sheets to the Engineer for required materials and supplies. Dispose of unused material and containers in accordance with the Federal Resource Conservation Recovery Act (RCRA) of 1976 as amended, and 1994 PA 451, Part 111 Hazardous Waste Management. Provide samples of permanent pavement marking materials upon request.

c. Construction Methods. The preparation and placement of permanent pavement markings shall conform to section 811 of the MDOT 2012 Standard Specifications, the plans, and as specified herein.

d. Measurement and Payment. Measure and pay for the completed work, as described, at the respective contract unit prices using the following respective pay items:

<u>Pay Item</u>	<u>Pay Unit</u>
Pavt Mrkg, Thermopl, Lt Turn Arrow Sym	Each
Pavt Mrkg, Thermopl, Only.....	Each
Pavt Mrkg, Thermopl, Rt Turn Arrow Sym	Each
Pavt Mrkg, Thermopl, Speed Hump Chevron, White	Each
Pavt Mrkg, Thermopl, Thru Arrow Sym	Each

Measure **Pavt Mrkg, Thermopl, Lt Turn Arrow Sym; Pavt Mrkg, Thermopl, Only; Pavt Mrkg, Thermopl, Rt Turn Arrow Sym; Pavt Mrkg, Thermopl, Speed Hump Chevron, White;** and **Pavt Mrkg, Thermopl, Thru Arrow Sym** individually in place by the unit each and pay for them at their respective contract unit prices, which prices include the costs for all labor, equipment and materials to complete the work.

CITY OF ANN ARBOR
DETAILED SPECIFICATION
FOR
MAINTENANCE OF TRAFFIC

AA:DAD

1 of 4

02/20/21

a. Description. The work consists of maintaining traffic at the locations identified on the “Schedule of Streets” for duration of the work. Maintain traffic in accordance with the plans, subsection 104.11 and section 812 of the Michigan Department of Transportation (MDOT) 2012 Standard Specifications for Construction, the Michigan Manual of Uniform Traffic Control Devices (MMUTCD), applicable supplemental specifications, as directed by the Engineer, and as herein specified.

The following, and herein included, Michigan Department of Transportation (MDOT) Maintaining Traffic Typicals, and Work Zone Device Standard Plans and Special Details apply to the project: M0020a, M0040a, M0110a, M140a, M0232a, M250a, M410a, M440a, M470a, M500a, WZD-100-A, and WZD-125-E.

These maintaining traffic provisions are subject to change in the event of special community activities.

Place permanent pavement marking items included in the contract per the MDOT 2012 Standard Specifications for Construction prior to the removal of any devices required to temporarily maintain traffic during construction. If approved to open to traffic prior to the placement of permanent pavement markings, place temporary pavement markings as directed by the Engineer.

b. Materials. Provide materials for all devices to temporarily control and maintain traffic meeting the requirements of section 812 of the MDOT 2012 Standard Specifications for Construction, the MMUTCD, and the applicable MDOT typicals and details included herein.

Use sign sizes shown on the plans, unless otherwise directed by the Engineer. Install all temporary signs on driven posts, which are to remain in the same place for 14 days or more. Install all other temporary signs on portable supports. Install all signs to have a minimum bottom height of 7.0 feet.

Use only plastic drums for channelizing devices when implementing any/all lane closures. 42 inch channelizing devices are permissible at certain locations with approval from the Engineer.

Furnish paper bills of lading/delivery tickets to the Engineer on the jobsite for all temporary traffic control devices delivered to the various project locations.

c. Construction. Use construction methods meeting the requirements of section 812 of the MDOT 2012 Standard Specifications for Construction, and as described herein.

Furnish and place all necessary temporary traffic control devices to maintain traffic during construction. Keep all work, construction equipment, and material storage behind the curb, or behind barricades or channelizing devices, all in combination with protective fencing, if required to protect open excavations, and do not in any way hamper vehicle movement or impair traffic vision. Provide protection to all uncured concrete sidewalk, driveways, and curb and gutter as

needed until all traffic, foot or otherwise, can cross without damage. Install additional barricades and protective fencing at the end of each day to insure no disturbance to the work area. Distances between warning, regulatory, and guide signs as shown on the typicals and details are approximate, and may require field adjustment, as directed by the Engineer.

Maintain two-way traffic as shown on the plans, access for local traffic on local streets, and always keep all intersections open to traffic unless specifically authorized in writing by the Engineer.

Maintain traffic to prevent vehicles from driving into active work areas. Remove and replace patch areas that extend more than halfway across the roadway to provide a minimum of half the pavement width at all times for maintaining traffic.

Remove existing pavement markings and place temporary pavement markings as directed by the Engineer.

All temporary traffic/pedestrian control devices furnished by the Contractor remain the property of the Contractor. The City is not responsible for stolen or damaged signs, barricades, plastic drums and other traffic maintenance items. Replace missing and/or damaged traffic control devices immediately, at no additional cost to the City.

1. Construction Influence Area (CIA). The CIA at each location consists of the width of the right-of-way and easements, and the limits of any advance temporary construction signing shown on the plans and applicable maintaining traffic typicals along the street under construction and any/all cross streets. Posted detour routes are not part of the CIA.

Furnish, erect, maintain, and upon completion of the work, remove all traffic control devices within and around the CIA, and along posted detour routes, for the safety and protection of traffic. This includes, but is not limited to, regulatory and warning signs, barricades, channeling devices and other minor devices where required by the Engineer.

Coordinate operations with all subcontractors, utilities, and/or other contractors performing work on this and other projects within, or adjacent to, the Construction Influence Area (CIA). Avoid conflicts in maintaining traffic operations, signing, and orderly progress of other contract work.

2. Permits. Prior to the start of construction, obtain a "Right-of-Way" Permit from City of Ann Arbor Customer Services Unit. Notify the Project Engineer and obtain a "Traffic Detour or Lane Closure" Permit from the Engineering Unit a minimum of 72 business hours prior to the implementation of any traffic shifts, lane closures and street closures. There are no fees associated with these permits.

3. Work Times and Restrictions. Conduct all work on Monday through Saturday between 7:00am and 8:00pm unless, prior to commencement of construction, the City authorizes a plan identifying alternate days and hours of work. Should night work be required for any reason, notify the Project Engineer a minimum of three (3) working days (72 hours) in advance of such work, and the work must have the approval of the City prior to commencement.

Only perform work of an emergency nature or work required to insure traffic safety on Sunday and only with prior approval by the City.

Perform no road work nor permit any traffic interruptions, including lane closures, on Sundays, and during the Memorial Day, Independence Day (July 4th), and Labor Day holiday periods unless otherwise authorized by the Engineer. All streets and sidewalks that can be open will be open. Trucking on or off site will not be permitted.

During non-working periods, any area with uncompleted work will have plastic drums at specific locations and protective fencing, as directed by the Engineer, and at no additional cost to the project.

4. **Traffic Restrictions.** At all times conduct work to insure the least possible obstruction to traffic and inconvenience to the public, and property owners including businesses and residents proximate to the work.

Do not interfere with traffic on major streets between the hours of 7:00 a.m. to 9:00 a.m. and 3:30 p.m. to 6:00 p.m. unless otherwise approved by the Engineer or as specified on a Lane Closure Permit. Make all major changes in traffic control either between 9:00 a.m. and 3:30 p.m. or between 7:00 p.m. and 6:30 a.m. in order to minimize interference with rush hour traffic. All traffic controls must be in place and ready for traffic each day by 6:30 a.m. and 3:30 p.m. The City will permit temporary obstruction of traffic for loading and unloading of trucks only if the Contractor provides traffic regulators (flag persons) in conformance with Part VI of the MMUTCD. During temporary obstructions, a minimum of two traffic regulators are required. Include the cost of traffic regulators (flag control) in the unit price for the contract pay item "**Traf Regulator Control**".

Maintain access to businesses, residences, and side street(s) within the CIA for the duration of the project. The Contractor shall make every effort to coordinate its operations to minimize interruptions affecting this access. Notify the Project Engineer forty-eight (48) hours in advance of performing any work on or near business or residential driveways, and stage work so that it is part-width when it is necessary to work in these areas. The Engineer will not allow the Contractor to prohibit access to businesses and residences during any phase of construction and may require traffic regulator control at its discretion.

Maintain 9 feet wide minimum lane widths and greater widths whenever feasible. Schedule work so not to require any traffic stoppage under any circumstance unless otherwise approved by the Engineer. Suspend work within the CIA during peak traffic hours, and/or at the direction of the Engineer when construction activity(s) unduly hamper or delay traffic.

5. **Emergency Services.** Notify local police, fire departments and emergency response units a minimum of three business days (72 hours) prior to the closure of any lanes, or traffic shifts causing restricted movements of traffic or restricted access. Keep "live" fire hydrants in or adjacent to the work and fire fighting forces made aware of their availability at all times during construction.

d. Measurement and Payment. Measure and pay for the completed work, as described, at the contract unit price using the following pay items in accordance with subsection 812.04 of the Standard Specifications for Construction.

<u>Pay Item</u>	<u>Pay Unit</u>
Barricade, Type III, High Intensity, Double Sided, Lighted, Furn	Each
Barricade, Type III, High Intensity, Double Sided, Lighted, Oper.....	Each
Channelizing Device, 42 inch, Fluorescent, Furn.....	Each
Channelizing Device, 42 inch, Fluorescent, Oper	Each
Lighted Arrow, Type C, Furn	Each
Lighted Arrow, Type C, Oper	Each
Plastic Drum, Fluorescent, Lighted, Furn.....	Each
Plastic Drum, Fluorescent, Lighted, Oper	Each
Sign Cover	Each
Sign, Portable, Changeable Message, Furn	Each
Sign, Portable, Changeable Message, Oper.....	Each
Sign, Type B, Temp, Prismatic, Furn	Square Foot
Sign, Type B, Temp, Prismatic, Oper.....	Square Foot
Sign, Type B, Temp, Prismatic, Special, Furn	Square Foot
Sign, Type B, Temp, Prismatic, Special, Oper.....	Square Foot
Traf Regulator Control.....	Lump Sum
Minor Traffic Control, Modified, Max \$____	Lump Sum

The quantities for maintaining traffic are estimates and based on the signing and related traffic control devices deemed necessary for this project as shown on the plans and applicable MDOT Maintaining Traffic Typical and include traffic regulators and minor traffic devices.

Payment for furnishing and operating temporary traffic control devices shall be for the maximum quantity in use on each street at any one time with exception to lighted arrows and portable changeable message signs, which payment shall be for furnishing and operating the maximum quantity in use at any one time during the entire project (all streets and/or phases).

Any additional signing or maintaining traffic devices required to expedite the construction is at the Contractor's expense unless approved by the Engineer.

Include any/all costs for transporting temporary traffic control devices in their respective contract unit prices bid for the individual traffic control items of work set up in the contract.

The Engineer will pay for temporary traffic control devices only once irrespective of the number of times moved. Include any/all costs for temporary traffic control devices not addressed by this detailed specification, or where there is no separate pay item in the contract, in the unit price for **Minor Traffic Control, Max \$_____**.

MINIMUM MERGING TAPER LENGTH "L" (FEET)

OFFSET FEET	POSTED SPEED LIMIT, MPH (PRIOR TO WORK AREA)									
	25	30	35	40	45	50	55	60	65	70
1	10	15	20	27	45	50	55	60	65	70
2	21	30	41	53	90	100	110	120	130	140
3	31	45	61	80	135	150	165	180	195	210
4	42	60	82	107	180	200	220	240	260	280
5	52	75	102	133	225	250	275	300	325	350
6	63	90	123	160	270	300	330	360	390	420
7	73	105	143	187	315	350	385	420	455	490
8	83	120	163	213	360	400	440	480	520	560
9	94	135	184	240	405	450	495	540	585	630
10	104	150	204	267	450	500	550	600	650	700
11	115	165	225	293	495	550	605	660	715	770
12	125	180	245	320	540	600	660	720	780	840
13	135	195	266	347	585	650	715	780	845	910
14	146	210	286	374	630	700	770	840	910	980
15	157	225	307	400	675	750	825	900	975	1050

TAPER LENGTH "L" IN FEET

THE FORMULAS FOR THE MINIMUM LENGTH OF A MERGING TAPER IN DERIVING THE "L" VALUES SHOWN IN THE ABOVE TABLES ARE AS FOLLOWS:

"L" = $\frac{W \times S^2}{60}$ WHERE POSTED SPEED PRIOR TO THE WORK AREA IS 40 MPH OR LESS

"L" = S x W WHERE POSTED SPEED PRIOR TO THE WORK AREA IS 45 MPH OR GREATER

- L = MINIMUM LENGTH OF MERGING TAPER
- S = POSTED SPEED LIMIT IN MPH PRIOR TO WORK AREA
- W = WIDTH OF OFFSET

TYPES OF TAPERS

UPSTREAM TAPERS

- MERGING TAPER
- SHIFTING TAPER
- SHOULDER TAPER
- TWO-WAY TRAFFIC TAPER

DOWNSTREAM TAPERS (USE IS OPTIONAL)

TAPER LENGTH

- L - MINIMUM
- 1/2 L - MINIMUM
- 1/3 L - MINIMUM
- 100' - MAXIMUM
- 100' - MINIMUM (PER LANE)

 TRAFFIC AND SAFETY MAINTAINING TRAFFIC TYPICAL	TABLES FOR "L", "D" AND "B" VALUES		
	DRAWN BY: CON:AE:djf	JUNE 2006	M0020a
CHECKED BY: BMM	PLAN DATE:	1 OF 2	
FILE: K:/DGN/TSR/STDS/ENGLISH/MNTTRF/M0020a.dgn		REV.	08/21/2006

DISTANCE BETWEEN TRAFFIC CONTROL DEVICES "D"
AND LENGTH OF LONGITUDINAL BUFFER SPACE ON
"WHERE WORKERS PRESENT" SEQUENCES

"D" DISTANCES	POSTED SPEED LIMIT, MPH (PRIOR TO WORK AREA)									
	25	30	35	40	45	50	55	60	65	70
D (FEET)	250	300	350	400	450	500	550	600	650	700

GUIDELINES FOR LENGTH OF
LONGITUDINAL BUFFER SPACE "B"

SPEED* MPH	LENGTH FEET
20	33
25	50
30	83
35	132
40	181
45	230
50	279
55	329
60	411
65	476
70	542

* POSTED SPEED, OFF PEAK 85TH PERCENTILE SPEED PRIOR TO WORK STARTING, OR THE ANTICIPATED OPERATING SPEED

1 BASED UPON AMERICAN ASSOCIATION OF STATE HIGHWAY AND TRANSPORTATION OFFICIALS (AASHTO) BRAKING DISTANCE PORTION OF STOPPING SIGHT DISTANCE FOR WET AND LEVEL PAVEMENTS (A POLICY ON GEOMETRIC DESIGN OF HIGHWAY AND STREETS), AASHTO. THIS AASHTO DOCUMENT ALSO RECOMMENDS ADJUSTMENTS FOR THE EFFECT OF GRADE ON STOPPING AND VARIATION FOR TRUCKS.

 Michigan Department of Transportation TRAFFIC AND SAFETY MAINTAINING TRAFFIC TYPICAL	TABLES FOR "L", "D" AND "B" VALUES		
	DRAWN BY: CON:AE:djf CHECKED BY: BMM	JUNE 2006 PLAN DATE:	M0020a
FILE: K:/DGN/TSR/STDS/ENGLISH/MNTTRF/M0020a.dgn REV. 08/21/2006			

SIGN PLACEMENT IS THE SAME FOR BOTH DIRECTIONS

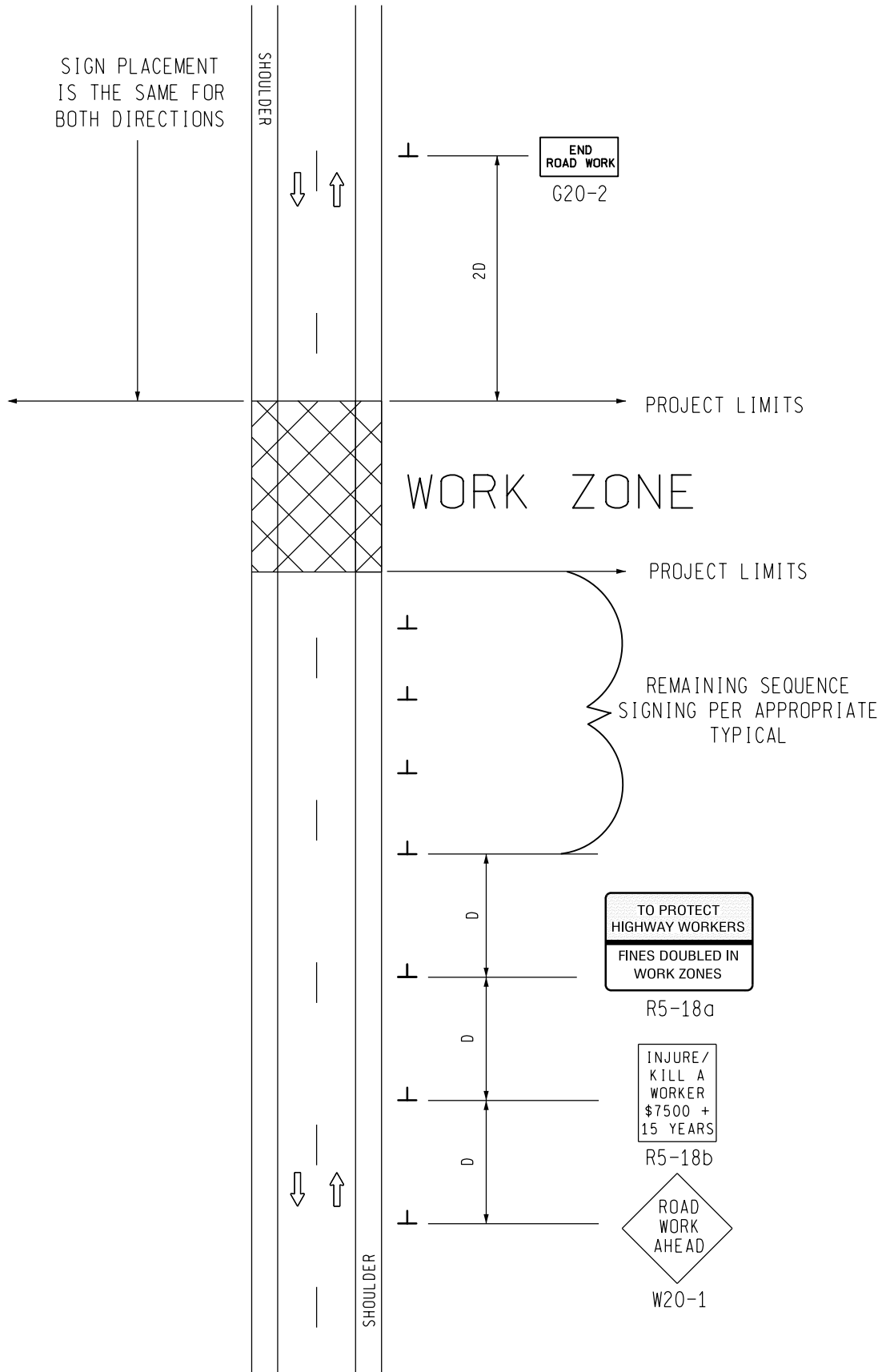

SIGN = 68 f+2 - TYPE B
FOR ONE DIRECTION OF TRAFFIC
W20-1 QUANTITY INCLUDED
WITH APPROPRIATE TYPICAL
FOR SEQUENCE SIGNING

MDOT
Michigan Department of Transportation
TRAFFIC AND SAFETY
MAINTAINING TRAFFIC
TYPICAL

TYPICAL ADVANCE SIGNING TREATMENT FOR LONG, INTERMEDIATE AND SHORT TERM STATIONARY WORK ZONE OPERATIONS OF LESS THAN TWO MILES IN LENGTH WHERE TRAFFIC CONTROL DEVICES MAY REMAIN AT END OF WORK DAY ON AN UNDIVIDED TWO-WAY ROADWAY

DRAWN BY: CON:AE:djf
CHECKED BY: BMM:CRB

OCTOBER 2011
PLAN DATE:

M0040a

SHEET
1 OF 2

NOT TO SCALE

FILE: PW_RD/TS/Typicals/Signs/MT NON FWY/M0040a.dgn REV. 10/13/2011

NOTES

- 30. THE APPROPRIATE ADVANCE SIGNING SEQUENCE(S), (M0030a THROUGH M0080a) SHALL BE USED ON ALL PROJECTS.
- 32. THESE SIGNS SHALL BE LEFT IN PLACE AT THEIR PRESCRIBED LOCATIONS FOR THE DURATION OF THE PROJECT AND UNTIL ALL TEMPORARY TRAFFIC CONTROL HAS BEEN REMOVED.
- 35. THESE SIGNS ARE INTENDED TO BE USED WITHIN THE LIMITS OF THE TEMPORARY SEQUENCE SIGNING AS IS SHOWN ON 1 OF 2. THESE SIGNS ARE NOT TO BE INTERMINGLED WITH ANY OTHER TEMPORARY SEQUENCE SIGNING EXCEPT AS SHOWN.



SIGN SIZES

G20-2	-	48" x 24"
R5-18a	-	96" x 60"
R5-18b	-	48" x 60"
W20-1	-	48" x 48"

 TRAFFIC AND SAFETY MAINTAINING TRAFFIC TYPICAL	TYPICAL ADVANCE SIGNING TREATMENT FOR LONG, INTERMEDIATE AND SHORT TERM STATIONARY WORK ZONE OPERATIONS OF LESS THAN TWO MILES IN LENGTH WHERE TRAFFIC CONTROL DEVICES MAY REMAIN AT END OF WORK DAY ON AN UNDIVIDED TWO-WAY ROADWAY						
DRAWN BY: CON:AE:djf CHECKED BY: BMM:CRB	<table style="width: 100%; border-collapse: collapse;"> <tr> <td style="width: 40%; border-bottom: 1px solid black;">OCTOBER 2011</td> <td style="width: 20%;"></td> <td style="width: 40%;"></td> </tr> <tr> <td style="text-align: center;">PLAN DATE:</td> <td style="text-align: center; vertical-align: middle; font-size: large;">M0040a</td> <td style="text-align: right; vertical-align: middle; font-size: small;">SHEET 2 OF 2</td> </tr> </table>	OCTOBER 2011			PLAN DATE:	M0040a	SHEET 2 OF 2
OCTOBER 2011							
PLAN DATE:	M0040a	SHEET 2 OF 2					
FILE: PW_RD/TS/Typicals/Signs/MT NON FWY/M0040a.dgn REV. 10/13/2011							

NOT TO SCALE

KEY

- • • CHANNELIZING DEVICES
-  LIGHTED ARROW PANEL (CAUTION MODE)
-  TRAFFIC FLOW
- REFLECTS EXISTING SPEED LIMIT
- * USE THE "NEXT -- MILES" SIGN WHEN SHOULDER CLOSURE EXCEEDS 1 MILE IN LENGTH

SIGN = 120 ft± - TYPE B
 W/PLAQUE = 132 ft± - TYPE B
 PLUS ADDITIONAL R2-1's
 THROUGHOUT WORK AREA

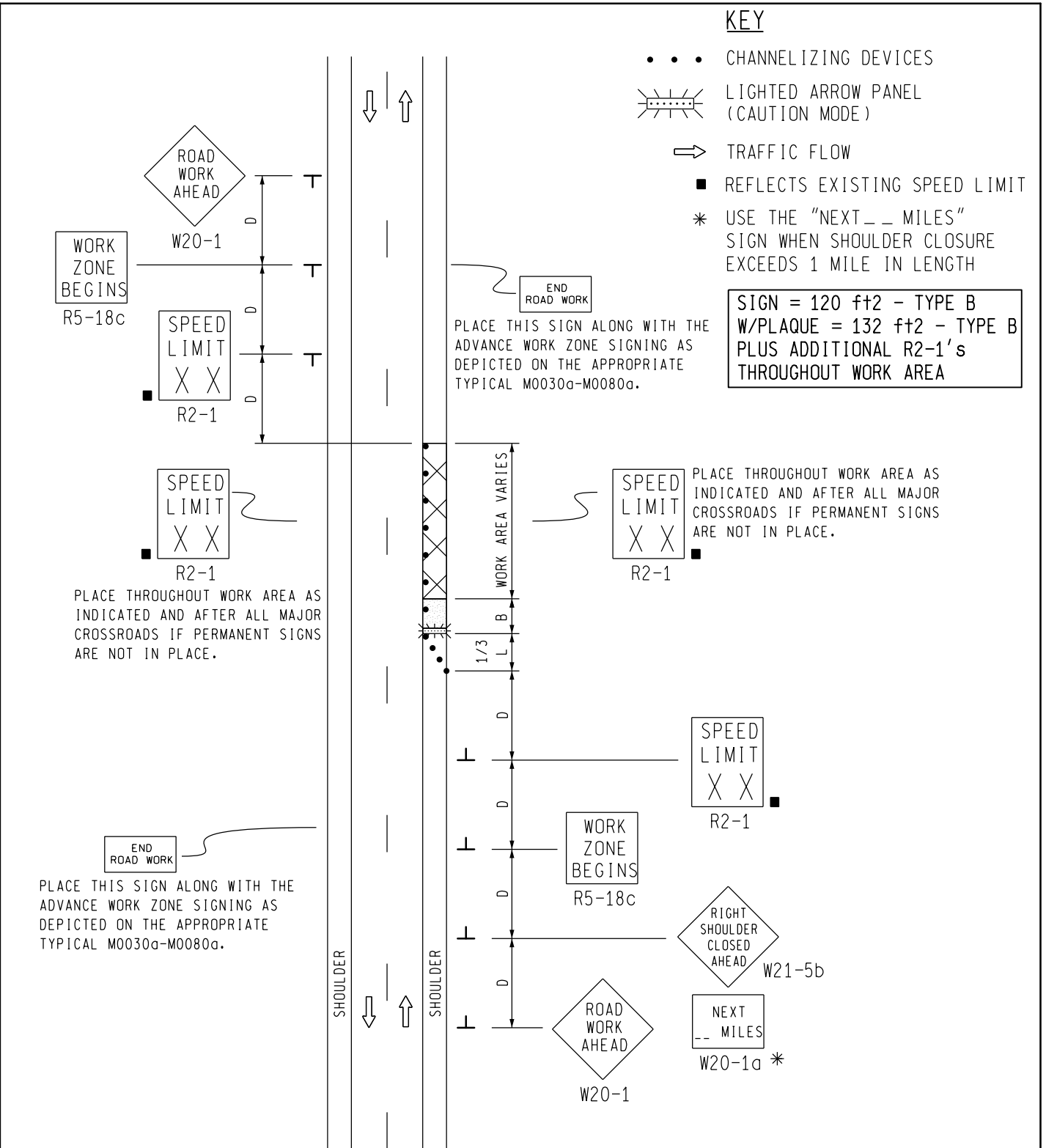

 Michigan Department of Transportation TRAFFIC AND SAFETY MAINTAINING TRAFFIC TYPICAL	TYPICAL TEMPORARY TRAFFIC CONTROL FOR A SHOULDER CLOSURE ON A TWO LANE TWO-WAY ROADWAY NO SPEED REDUCTION	
	DRAWN BY: CON:AE:djf CHECKED BY: BMM:CRB	OCTOBER 2011 PLAN DATE:
FILE: PW_RD/TS/Typicals/Signs/MT NON FWY/M0110a.dgn REV. 10/04/2011		

NOT TO SCALE

NOTES

1. D = DISTANCE BETWEEN TRAFFIC CONTROL DEVICES
 $1/3 L$ = MINIMUM LENGTH OF TAPER
 B = LENGTH OF LONGITUDINAL BUFFER
 SEE M0020a FOR "D," "L," AND "B" VALUES
2. ALL NON-APPLICABLE SIGNING WITHIN THE CIA SHALL BE MODIFIED TO FIT CONDITIONS, COVERED OR REMOVED.
3. DISTANCES BETWEEN SIGNS, THE VALUES FOR WHICH ARE SHOWN IN TABLE D, ARE APPROXIMATE AND MAY NEED ADJUSTING AS DIRECTED BY THE ENGINEER.
- 3A. THE "WORK ZONE BEGINS" (R5-18c) SIGN SHALL BE USED ONLY IN THE INITIAL SIGNING SEQUENCE IN THE WORK ZONE. SUBSEQUENT SEQUENCES IN THE SAME WORK ZONE SHALL OMIT THIS SIGN AND THE QUANTITIES SHALL BE ADJUSTED APPROPRIATELY.
- 4E. THE MAXIMUM RECOMMENDED DISTANCE(S) BETWEEN CHANNELIZING DEVICES SHOULD BE EQUAL IN FEET TO THE POSTED SPEED IN MILES PER HOUR ON TAPER(S) AND TWICE THE POSTED SPEED IN THE PARALLEL AREA(S).
5. FOR OVERNIGHT CLOSURES, TYPE III BARRICADES SHALL BE LIGHTED.
6. WHEN CALLED FOR IN THE FHWA ACCEPTANCE LETTER FOR THE SIGN SYSTEM SELECTED, THE TYPE A WARNING FLASHER, SHOWN ON THE WARNING SIGNS, SHALL BE POSITIONED ON THE SIDE OF THE SIGN NEAREST THE ROADWAY.
7. ALL TEMPORARY SIGNS, TYPE III BARRICADES, THEIR SUPPORT SYSTEMS AND LIGHTING REQUIREMENTS SHALL MEET NCHRP 350 CRASHWORTHLY REQUIREMENTS STIPULATED IN THE CURRENT EDITION OF THE MICHIGAN MANUAL ON UNIFORM TRAFFIC CONTROL DEVICES, THE CURRENT EDITION OF THE STANDARD SPECIFICATIONS FOR CONSTRUCTION, THE STANDARD PLANS AND APPLICABLE SPECIAL PROVISIONS. ONLY DESIGNS AND MATERIALS APPROVED BY MDOT WILL BE ALLOWED.
8. WHEN BUFFER AREAS ARE ESTABLISHED, THERE SHALL BE NO EQUIPMENT OR MATERIALS STORED OR WORK CONDUCTED IN THE BUFFER AREA.
- 29A. THE TYPE OF REFLECTIVE SHEETING USED FOR THE W20-1a PLAQUE SHALL BE THE SAME AS THE TYPE USED FOR THE PARENT SIGN.

SIGN SIZES

DIAMOND WARNING	- 48" x 48"
W20-1a PLAQUE	- 48" x 36"
R2-1 REGULATORY	- 48" x 60"
R5-18c REGULATORY	- 48" x 48"

NOT TO SCALE

 TRAFFIC AND SAFETY MAINTAINING TRAFFIC TYPICAL	TYPICAL TEMPORARY TRAFFIC CONTROL FOR A SHOULDER CLOSURE ON A TWO LANE TWO-WAY ROADWAY NO SPEED REDUCTION	
	DRAWN BY: CON:AE:djf	OCTOBER 2011
CHECKED BY: BMM:CRB	PLAN DATE:	M0110a
FILE: PW_RD/TS/Typicals/Signs/MT NON FWY/M0110a.dgn REV. 10/04/2011		





PLACE THROUGHOUT WORK AREA AS INDICATED AND AFTER ALL MAJOR CROSSROADS IF PERMANENT SIGNS ARE NOT IN PLACE.

PLACE THIS SIGN ALONG WITH THE ADVANCE WORK ZONE SIGNING AS DEPICTED ON THE APPROPRIATE TYPICAL M0030a-M0080a.

PLACE THROUGHOUT WORK AREA AS INDICATED AND AFTER ALL MAJOR CROSSROADS IF PERMANENT SIGNS ARE NOT IN PLACE.

PLACE THIS SIGN ALONG WITH THE ADVANCE WORK ZONE SIGNING AS DEPICTED ON THE APPROPRIATE TYPICAL M0030a-M0080a.

KEY

-  TRAFFIC REGULATOR
-  CHANNELIZING DEVICES
-  LIGHTED ARROW PANEL (CAUTION MODE)
-  TRAFFIC FLOW
-  REFLECTS EXISTING SPEED LIMIT

SIGN = 200 ft± - TYPE B PLUS ADDITIONAL R2-1's THROUGHOUT WORK AREA

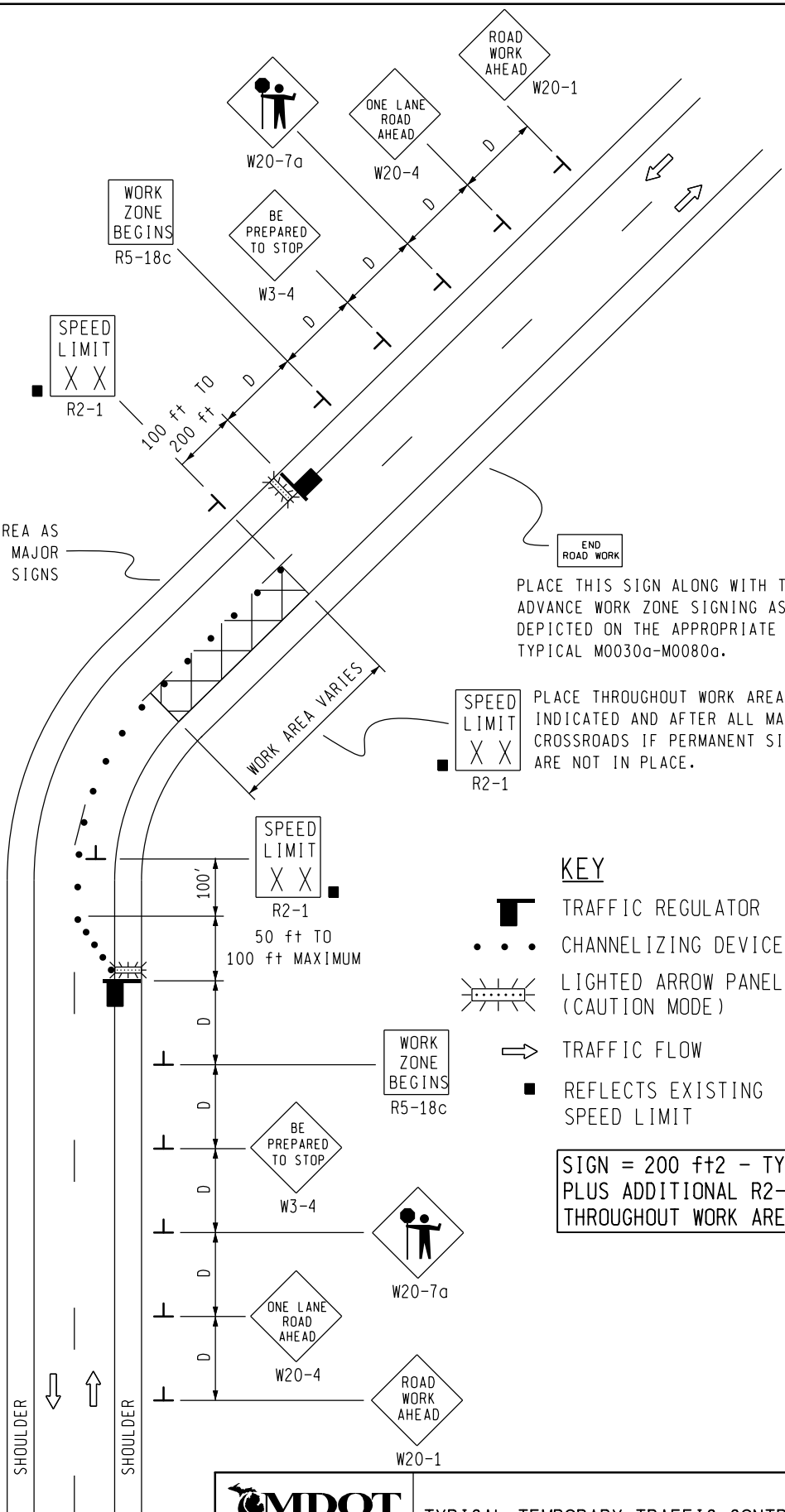

MDOT
Michigan Department of Transportation
TRAFFIC AND SAFETY
MAINTAINING TRAFFIC
TYPICAL

DRAWN BY: CON:AE:djf
CHECKED BY: BMM:CRB

TYPICAL TEMPORARY TRAFFIC CONTROL FOR A TWO-LANE TWO-WAY ROADWAY WHERE ONE LANE IS CLOSED UTILIZING TRAFFIC REGULATORS, NO SPEED REDUCTION

OCTOBER 2011	M0140a	SHEET 1 OF 2
PLAN DATE:		

NOT TO SCALE

NOTES

- 1H. D = DISTANCE BETWEEN TRAFFIC CONTROL DEVICES AND LENGTH OF LONGITUDINAL BUFFERS
SEE **M0020a** FOR "D" VALUES.
2. ALL NON-APPLICABLE SIGNING WITHIN THE CIA SHALL BE MODIFIED TO FIT CONDITIONS, COVERED OR REMOVED.
3. DISTANCES BETWEEN SIGNS, THE VALUES FOR WHICH ARE SHOWN IN TABLE D, ARE APPROXIMATE AND MAY NEED ADJUSTING AS DIRECTED BY THE ENGINEER.
- 3A. THE "WORK ZONE BEGINS" (R5-18c) SIGN SHALL BE USED ONLY IN THE INITIAL SIGNING SEQUENCE IN THE WORK ZONE. SUBSEQUENT SEQUENCES IN THE SAME WORK ZONE SHALL OMIT THIS SIGN AND THE QUANTITIES SHALL BE ADJUSTED APPROPRIATELY.
- 4A. THE MAXIMUM RECOMMENDED DISTANCE(S) BETWEEN CHANNELIZING DEVICES IN THE TAPER AREA(S) SHOULD BE 15 FEET AND SHOULD BE EQUAL IN FEET TO TWICE THE POSTED SPEED IN MILES PER HOUR IN THE PARALLEL AREA(S).
5. FOR OVERNIGHT CLOSURES, TYPE III BARRICADES SHALL BE LIGHTED.
6. WHEN CALLED FOR IN THE FHWA ACCEPTANCE LETTER FOR THE SIGN SYSTEM SELECTED, THE TYPE A WARNING FLASHER, SHOWN ON THE WARNING SIGNS, SHALL BE POSITIONED ON THE SIDE OF THE SIGN NEAREST THE ROADWAY.
7. ALL TEMPORARY SIGNS, TYPE III BARRICADES, THEIR SUPPORT SYSTEMS AND LIGHTING REQUIREMENTS SHALL MEET NCHRP 350 CRASHWORTHLY REQUIREMENTS STIPULATED IN THE CURRENT EDITION OF THE MICHIGAN MANUAL ON UNIFORM TRAFFIC CONTROL DEVICES, THE CURRENT EDITION OF THE STANDARD SPECIFICATIONS FOR CONSTRUCTION, THE STANDARD PLANS AND APPLICABLE SPECIAL PROVISIONS. ONLY DESIGNS AND MATERIALS APPROVED BY MDOT WILL BE ALLOWED.
9. ALL TRAFFIC REGULATORS SHALL BE PROPERLY TRAINED AND SUPERVISED.
- 9A. IN ANY OPERATION INVOLVING MORE THAN ONE TRAFFIC REGULATOR, ONE PERSON SHOULD BE DESIGNATED AS HEAD TRAFFIC REGULATOR.
10. ALL TRAFFIC REGULATORS' CONDUCT, THEIR EQUIPMENT, AND TRAFFIC REGULATING PROCEDURES SHALL CONFORM TO THE CURRENT EDITION OF THE MICHIGAN MANUAL OF UNIFORM TRAFFIC CONTROL DEVICES (MMUTCD) AND THE CURRENT EDITION OF THE MDOT HANDBOOK ENTITLED "TRAFFIC REGULATORS INSTRUCTION MANUAL."
11. WHEN TRAFFIC REGULATING IS ALLOWED DURING THE HOURS OF DARKNESS, APPROPRIATE LIGHTING SHALL BE PROVIDED TO SUFFICIENTLY ILLUMINATE THE TRAFFIC REGULATOR'S STATIONS.
- 12E. THE MAXIMUM DISTANCE BETWEEN THE TRAFFIC REGULATORS SHALL BE NO MORE THAN 2 MILES IN LENGTH UNLESS RESTRICTED FURTHER IN THE SPECIAL PROVISIONS FOR MAINTAINING TRAFFIC. ALL SEQUENCES OF MORE THAN 2 MILES IN LENGTH WILL REQUIRE WRITTEN PERMISSION FROM THE ENGINEER BEFORE PROCEEDING.
13. WHEN INTERSECTING ROADS OR SIGNIFICANT TRAFFIC GENERATORS (SHOPPING CENTERS, MOBILE HOME PARKS, ETC.) OCCUR WITHIN THE ONE-LANE TWO-WAY OPERATION, INTERMEDIATE TRAFFIC REGULATORS AND APPROPRIATE SIGNING SHALL BE PLACED AT THESE LOCATIONS.
14. ADDITIONAL SIGNING AND/OR ELONGATED SIGNING SEQUENCES SHOULD BE USED WHEN TRAFFIC VOLUMES ARE SIGNIFICANT ENOUGH TO CREATE BACKUPS BEYOND THE W3-4 SIGNS.
15. THE HAND HELD (PADDLE) SIGNS REQUIRED BY THE MMUTCD TO CONTROL TRAFFIC WILL BE PAID FOR AS PART OF FLAG CONTROL.
- 28E. THE TRAFFIC REGULATORS SHOULD BE POSITIONED AT OR NEAR THE SIDE OF THE ROAD SO THAT THEY ARE SEEN CLEARLY AT A MINIMUM DISTANCE OF 500 FEET. THIS MAY REQUIRE EXTENDING THE BEGINNING OF THE LANE CLOSURE TO OVERCOME VIEWING PROBLEMS CAUSED BY HILLS AND CURVES.

SIGN SIZES

DIAMOND WARNING - 48" x 48"
 R2-1 REGULATORY - 48" x 60"
 R5-18c REGULATORY - 48" x 48"

NOT TO SCALE

 TRAFFIC AND SAFETY MAINTAINING TRAFFIC TYPICAL	TYPICAL TEMPORARY TRAFFIC CONTROL FOR A TWO-LANE TWO-WAY ROADWAY WHERE ONE LANE IS CLOSED UTILIZING TRAFFIC REGULATORS, NO SPEED REDUCTION		
DRAWN BY: CON:AE:djf	OCTOBER 2011	M0140a	SHEET
CHECKED BY: BMM:CRB	PLAN DATE:		2 OF 2
FILE: PW_RD/TS/Typicals/Signs/MT NON FWY/M0140a.dgn REV. 10/04/2011			

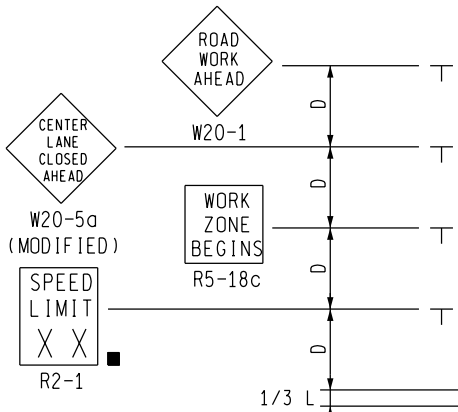

NO SPEED REDUCTION THIS DIRECTION

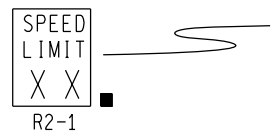

PLACE THROUGHOUT WORK AREA AS INDICATED AND AFTER ALL MAJOR CROSSROADS IF PERMANENT SIGNS ARE NOT IN PLACE.

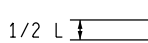

PLACE THIS SIGN ALONG WITH THE ADVANCE WORK ZONE SIGNING AS DEPICTED ON THE APPROPRIATE TYPICAL M0030a-M0050a.

PLACE THIS SIGN ALONG WITH THE ADVANCE WORK ZONE SIGNING AS DEPICTED ON THE APPROPRIATE TYPICAL M0030a-M0050a.

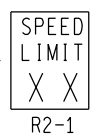
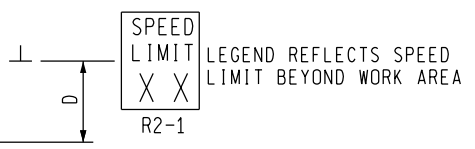

PLACE THROUGHOUT WORK AREA AS INDICATED IN THE NOTES.

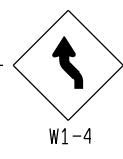
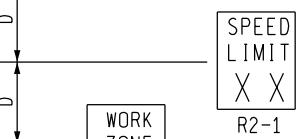

KEY

- • • CHANNELIZING DEVICES
- ⚡ LIGHTED ARROW PANEL (CAUTION MODE)
- ➡ TRAFFIC FLOW
- REFLECTS EXISTING SPEED LIMIT

SIGN = 200 f+2 - TYPE B PLUS ADDITIONAL R2-1's THROUGHOUT WORK AREA

↑ MAXIMUM 10MPH SPEED REDUCTION THIS DIRECTION

MDOT
Michigan Department of Transportation
TRAFFIC AND SAFETY
MAINTAINING TRAFFIC
TYPICAL

TYPICAL TEMPORARY TRAFFIC CONTROL FOR CLOSING ONE LANE OF A THREE LANE ROADWAY WITH CLFLTO AND SHIFTING ONE THROUGH LANE INTO THE CLFLTO USING A SINGLE STEP DOWN IN SPEED LIMIT IN ONE DIRECTION ONLY

DRAWN BY: CON:AE:DJF
CHECKED BY: BMM:CRB

OCTOBER 2011
PLAN DATE:

M0232a

SHEET 1 OF 2

NOT TO SCALE

NOTES

- 1F. D = DISTANCE BETWEEN TRAFFIC CONTROL DEVICES
 $1/2 L$, AND $1/3 L$ = MINIMUM LENGTH OF TAPER
 B = LENGTH OF LONGITUDINAL BUFFER
 SEE M0020a FOR "D," "L," AND "B" VALUES
2. ALL NON-APPLICABLE SIGNING WITHIN THE CIA SHALL BE MODIFIED TO FIT CONDITIONS, COVERED OR REMOVED.
3. DISTANCES BETWEEN SIGNS, THE VALUES FOR WHICH ARE SHOWN IN TABLE D, ARE APPROXIMATE AND MAY NEED ADJUSTING AS DIRECTED BY THE ENGINEER.
- 3A. THE "WORK ZONE BEGINS" (R5-18c) SIGN SHALL BE USED ONLY IN THE INITIAL SIGNING SEQUENCE IN THE WORK ZONE. SUBSEQUENT SEQUENCES IN THE SAME WORK ZONE SHALL OMIT THIS SIGN AND THE QUANTITIES SHALL BE ADJUSTED APPROPRIATELY.
- 4E. THE MAXIMUM RECOMMENDED DISTANCE(S) BETWEEN CHANNELIZING DEVICES SHOULD BE EQUAL IN FEET TO THE POSTED SPEED IN MILES PER HOUR ON TAPER(S) AND TWICE THE POSTED SPEED IN THE PARALLEL AREA(S).
5. FOR OVERNIGHT CLOSURES, TYPE III BARRICADES SHALL BE LIGHTED.
6. THE TYPE A WARNING FLASHER SHOWN ON THE WARNING SIGNS SHALL BE POSITIONED ON THE SIDE OF THE SIGN NEAREST THE ROADWAY.
7. ALL TEMPORARY SIGNS, TYPE III BARRICADES, THEIR SUPPORT SYSTEMS AND LIGHTING REQUIREMENTS SHALL MEET NCHRP 350 CRASHWORTHLY REQUIREMENTS STIPULATED IN THE CURRENT EDITION OF THE MICHIGAN MANUAL ON UNIFORM TRAFFIC CONTROL DEVICES, THE CURRENT EDITION OF THE STANDARD SPECIFICATIONS FOR CONSTRUCTION, THE STANDARD PLANS AND APPLICABLE SPECIAL PROVISIONS. ONLY DESIGNS AND MATERIALS APPROVED BY MDOT WILL BE ALLOWED.
8. WHEN BUFFER AREAS ARE ESTABLISHED, THERE SHALL BE NO EQUIPMENT OR MATERIALS STORED OR WORK CONDUCTED IN THE BUFFER AREA.
- 16A. ADDITIONAL SPEED LIMIT SIGNS REFLECTING THE REDUCED SPEED SHALL BE PLACED AFTER EACH MAJOR CROSSROAD THAT INTERSECTS THE WORK AREA WHERE THE REDUCED SPEED IS IN EFFECT, AND AT INTERVALS ALONG THE ROADWAY SUCH THAT NO SPEED LIMIT SIGNS REFLECTING THE REDUCED SPEED ARE MORE THAN TWO MILES APART.
- 16B. WHEN REDUCED SPEED LIMITS ARE UTILIZED IN THE WORK AREA, ADDITIONAL SPEED LIMIT SIGNS RETURNING TRAFFIC TO ITS NORMAL SPEED SHALL BE PLACED BEYOND THE LIMITS OF THE REDUCED SPEED AS INDICATED.
- 16E. WHEN EXISTING SPEED LIMITS ARE REDUCED MORE THAN 10 MPH, THE SPEED LIMIT SHALL BE STEPPED DOWN IN NO MORE THAN 10 MPH INCREMENTS.
21. ALL EXISTING PAVEMENT MARKINGS WHICH ARE IN CONFLICT WITH EITHER PROPOSED CHANGES IN TRAFFIC PATTERNS OR PROPOSED TEMPORARY TRAFFIC MARKINGS, SHALL BE REMOVED BEFORE ANY CHANGE IS MADE IN THE TRAFFIC PATTERN. EXCEPTION WILL BE MADE FOR DAYTIME-ONLY TRAFFIC PATTERNS THAT ARE ADEQUATELY DELINEATED BY OTHER TRAFFIC CONTROL DEVICES.

SIGN SIZES

DIAMOND WARNING	- 48" x 48"
W1-6 WARNING	- 48" x 24"
RECTANGULAR REGULATORY	- 48" x 60"
R5-18c REGULATORY	- 48" x 48"

NOT TO SCALE

 TRAFFIC AND SAFETY MAINTAINING TRAFFIC TYPICAL	TYPICAL TEMPORARY TRAFFIC CONTROL FOR CLOSING ONE LANE OF A THREE LANE ROADWAY WITH CLFLTO AND SHIFTING ONE THROUGH LANE INTO THE CLFLTO USING A SINGLE STEP DOWN IN SPEED LIMIT IN ONE DIRECTION ONLY		
	DRAWN BY: CON:AE:DJF	OCTOBER 2011	M0232a
CHECKED BY: BMM:CRB	PLAN DATE:	2 OF 2	
FILE: PW: RD/T&S/Typicals/Signs/MT/MT NonFwy/M0232a REV. 10/18/2011			

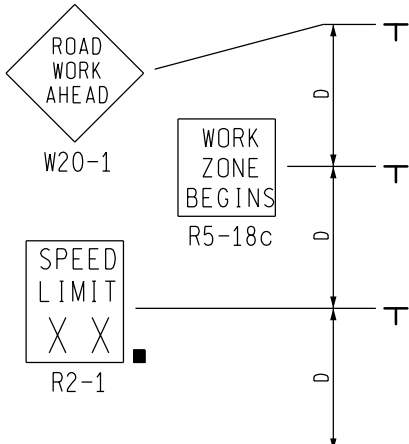

NO SPEED REDUCTION THIS DIRECTION

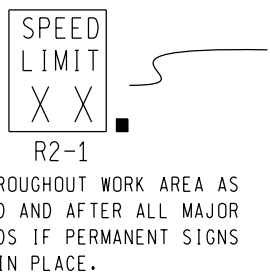

PLACE THROUGHOUT WORK AREA AS INDICATED AND AFTER ALL MAJOR CROSSROADS IF PERMANENT SIGNS ARE NOT IN PLACE.

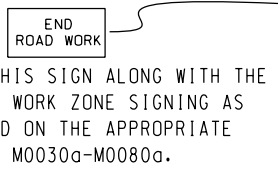

PLACE THIS SIGN ALONG WITH THE ADVANCE WORK ZONE SIGNING AS DEPICTED ON THE APPROPRIATE TYPICAL M0030a-M0080a.

KEY

- • • CHANNELIZING DEVICES
- ← LIGHTED ARROW PANEL
- TRAFFIC FLOW
- REFLECTS EXISTING SPEED LIMIT

SIGN = 172 f+2 - TYPE B PLUS ADDITIONAL R2-1's THROUGHOUT WORK AREA

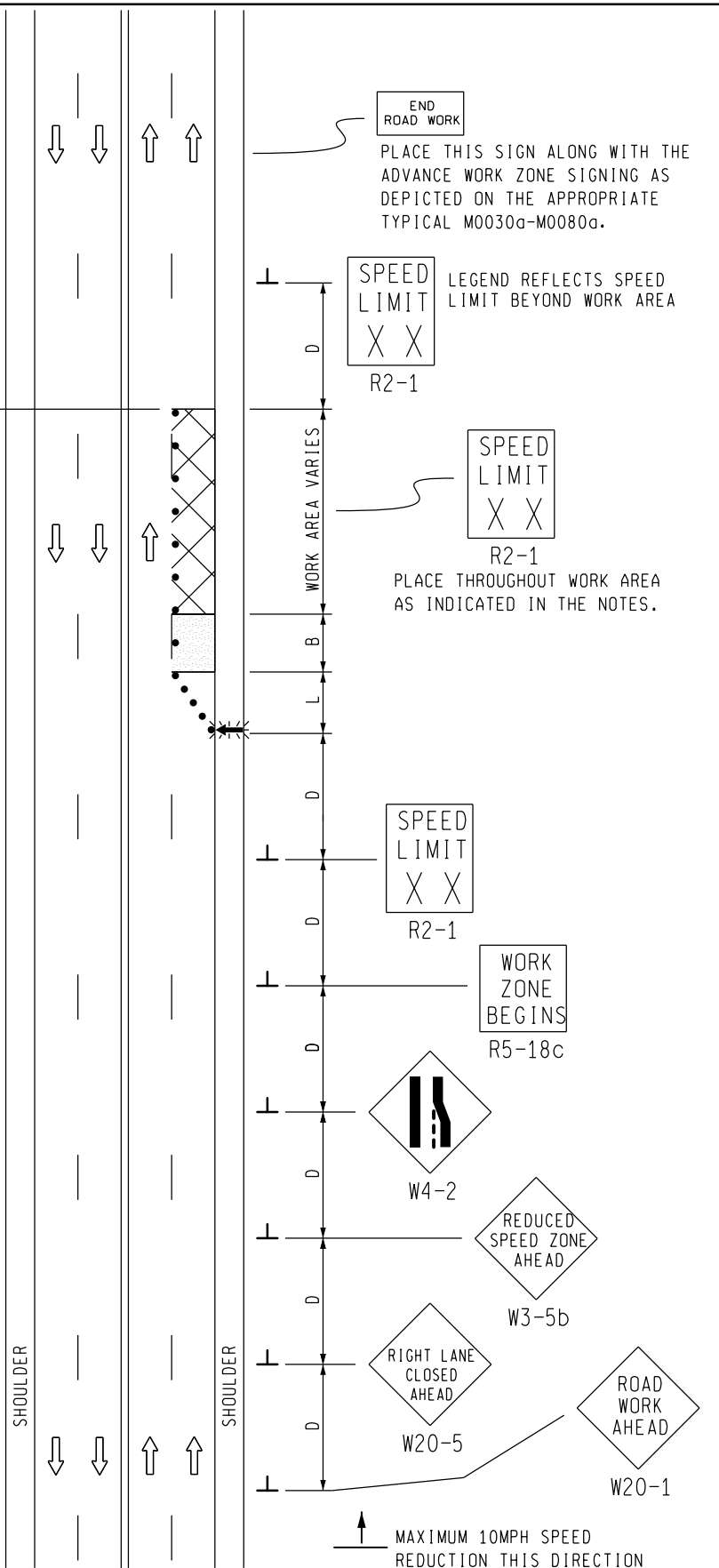

END ROAD WORK
PLACE THIS SIGN ALONG WITH THE ADVANCE WORK ZONE SIGNING AS DEPICTED ON THE APPROPRIATE TYPICAL M0030a-M0080a.

SPEED LIMIT XX
R2-1
LEGEND REFLECTS SPEED LIMIT BEYOND WORK AREA

SPEED LIMIT XX
R2-1
PLACE THROUGHOUT WORK AREA AS INDICATED IN THE NOTES.

SPEED LIMIT XX
R2-1

WORK ZONE BEGINS
R5-18c

RIGHT LANE CLOSED AHEAD
W20-5

REDUCED SPEED ZONE AHEAD
W3-5b

ROAD WORK AHEAD
W20-1

MAXIMUM 10MPH SPEED REDUCTION THIS DIRECTION

MDOT
Michigan Department of Transportation
TRAFFIC AND SAFETY
MAINTAINING TRAFFIC
TYPICAL

TYPICAL TEMPORARY TRAFFIC CONTROL FOR A ONE-LANE CLOSURE ON AN UNDIVIDED MULTI-LANE ROADWAY USING A SINGLE STEP DOWN IN SPEED LIMIT IN ONE DIRECTION ONLY

DRAWN BY: CON:AE:djf
CHECKED BY: BMM:CRB

OCTOBER 2011
PLAN DATE:

M0250a

SHEET
1 OF 2

NOT TO SCALE

NOTES

- 1B. D = DISTANCE BETWEEN TRAFFIC CONTROL DEVICES
L = MINIMUM LENGTH OF TAPER
B = LENGTH OF LONGITUDINAL BUFFER
SEE M0020a FOR "D," "L," AND "B" VALUES
2. ALL NON-APPLICABLE SIGNING WITHIN THE CIA SHALL BE MODIFIED TO FIT CONDITIONS, COVERED OR REMOVED.
3. DISTANCES BETWEEN SIGNS, THE VALUES FOR WHICH ARE SHOWN IN TABLE D, ARE APPROXIMATE AND MAY NEED ADJUSTING AS DIRECTED BY THE ENGINEER.
- 3A. THE "WORK ZONE BEGINS" (R5-18c) SIGN SHALL BE USED ONLY IN THE INITIAL SIGNING SEQUENCE IN THE WORK ZONE. SUBSEQUENT SEQUENCES IN THE SAME WORK ZONE SHALL OMIT THIS SIGN AND THE QUANTITIES SHALL BE ADJUSTED APPROPRIATELY.
- 4E. THE MAXIMUM RECOMMENDED DISTANCE(S) BETWEEN CHANNELIZING DEVICES SHOULD BE EQUAL IN FEET TO THE POSTED SPEED IN MILES PER HOUR ON TAPER(S) AND TWICE THE POSTED SPEED IN THE PARALLEL AREA(S).
5. FOR OVERNIGHT CLOSURES, TYPE III BARRICADES SHALL BE LIGHTED.
6. WHEN CALLED FOR IN THE FHWA ACCEPTANCE LETTER FOR THE SIGN SYSTEM SELECTED, THE TYPE A WARNING FLASHER, SHOWN ON THE WARNING SIGNS, SHALL BE POSITIONED ON THE SIDE OF THE SIGN NEAREST THE ROADWAY.
7. ALL TEMPORARY SIGNS, TYPE III BARRICADES, THEIR SUPPORT SYSTEMS AND LIGHTING REQUIREMENTS SHALL MEET NCHRP 350 CRASHWORTHY REQUIREMENTS STIPULATED IN THE CURRENT EDITION OF THE MICHIGAN MANUAL ON UNIFORM TRAFFIC CONTROL DEVICES, THE CURRENT EDITION OF THE STANDARD SPECIFICATIONS FOR CONSTRUCTION, THE STANDARD PLANS AND APPLICABLE SPECIAL PROVISIONS. ONLY DESIGNS AND MATERIALS APPROVED BY MDOT WILL BE ALLOWED.
8. WHEN BUFFER AREAS ARE ESTABLISHED, THERE SHALL BE NO EQUIPMENT OR MATERIALS STORED OR WORK CONDUCTED IN THE BUFFER AREA.
- 16A. ADDITIONAL SPEED LIMIT SIGNS REFLECTING THE REDUCED SPEED SHALL BE PLACED AFTER EACH MAJOR CROSSROAD THAT INTERSECTS THE WORK AREA WHERE THE REDUCED SPEED IS IN EFFECT, AND AT INTERVALS ALONG THE ROADWAY SUCH THAT NO SPEED LIMIT SIGNS REFLECTING THE REDUCED SPEED ARE MORE THAN TWO MILES APART.
- 16B. WHEN REDUCED SPEED LIMITS ARE UTILIZED IN THE WORK AREA, ADDITIONAL SPEED LIMIT SIGNS RETURNING TRAFFIC TO ITS NORMAL SPEED SHALL BE PLACED BEYOND THE LIMITS OF THE REDUCED SPEED AS INDICATED.
- 16E. WHEN EXISTING SPEED LIMITS ARE REDUCED MORE THAN 10 MPH, THE SPEED LIMIT SHALL BE STEPPED DOWN IN NO MORE THAN 10 MPH INCREMENTS.
21. ALL EXISTING PAVEMENT MARKINGS WHICH ARE IN CONFLICT WITH EITHER PROPOSED CHANGES IN TRAFFIC PATTERNS OR PROPOSED TEMPORARY TRAFFIC MARKINGS, SHALL BE REMOVED BEFORE ANY CHANGE IS MADE IN THE TRAFFIC PATTERN. EXCEPTION WILL BE MADE FOR DAYTIME-ONLY TRAFFIC PATTERNS THAT ARE ADEQUATELY DELINEATED BY OTHER TRAFFIC CONTROL DEVICES.
26. THE LIGHTED ARROW PANEL SHALL BE LOCATED AT THE BEGINNING OF THE TAPER AS SHOWN. WHEN PHYSICAL LIMITATIONS RESTRICT ITS PLACEMENT AS INDICATED, THEN IT SHALL BE PLACED AS CLOSE TO THE BEGINNING OF THE TAPER AS POSSIBLE.

SIGN SIZES

DIAMOND WARNING	- 48" x 48"
RECTANGULAR REGULATORY	- 48" x 60"
R5-18c REGULATORY	- 48" x 48"

NOT TO SCALE

 TRAFFIC AND SAFETY MAINTAINING TRAFFIC TYPICAL	TYPICAL TEMPORARY TRAFFIC CONTROL FOR A ONE-LANE CLOSURE ON AN UNDIVIDED MULTI-LANE ROADWAY USING A SINGLE STEP DOWN IN SPEED LIMIT IN ONE DIRECTION ONLY		
DRAWN BY: CON:AE:djf	OCTOBER 2011	M0250a	SHEET
CHECKED BY: BMM:CRB	PLAN DATE:		2 OF 2
FILE: PW_RD/TS/Typicals/Signs/MT NON FWY/M0250a.dgn REV. 10/11/2011			

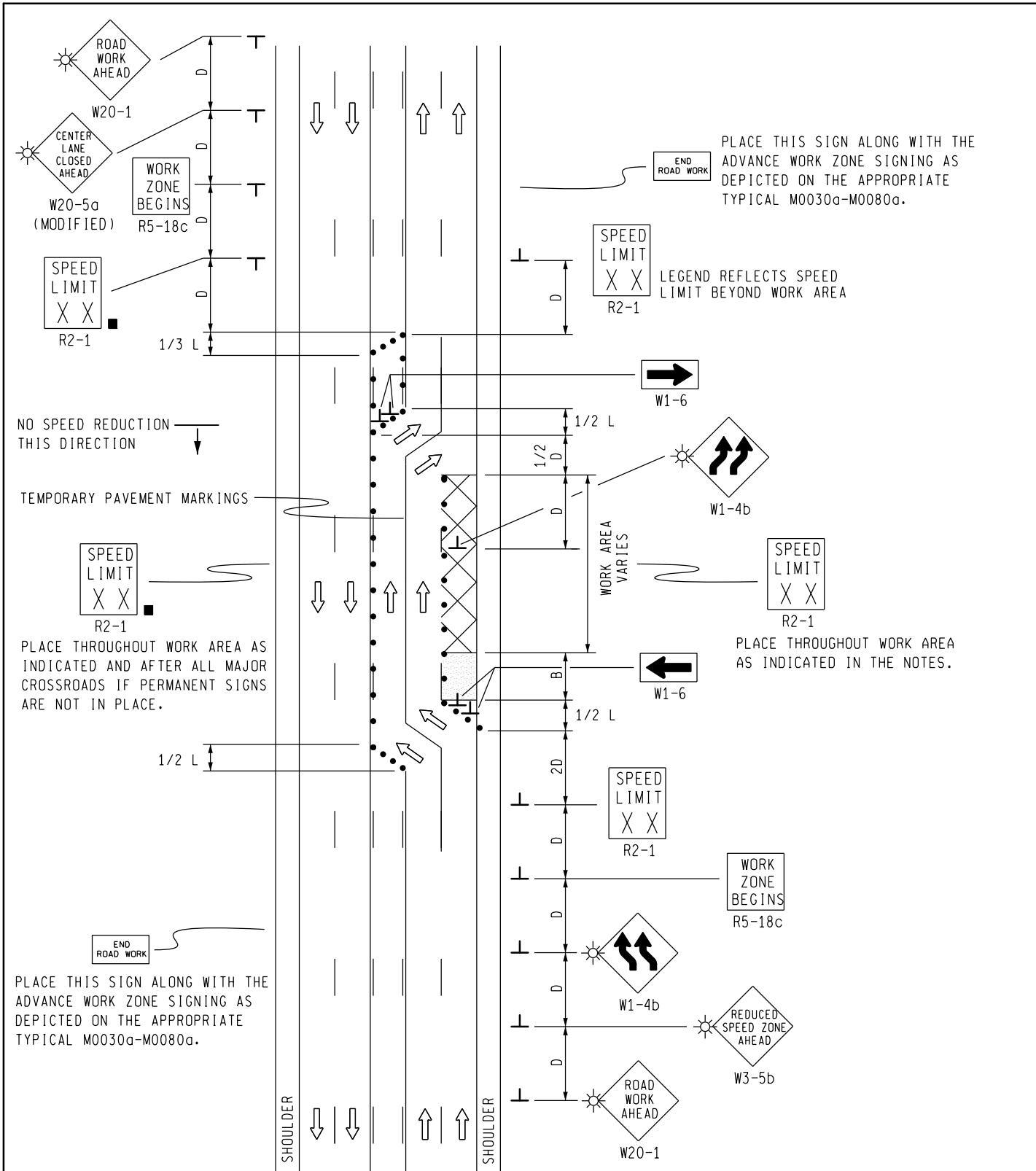

KEY

- • • CHANNELIZING DEVICES
- ☀ TYPE A WARNING FLASHER (REQUIRED)
- ➡ TRAFFIC FLOW
- REFLECTS EXISTING SPEED LIMIT

SIGN = 220 ft±2 - TYPE B PLUS ADDITIONAL R2-1's THROUGHOUT WORK AREA

↑ MAXIMUM 10MPH SPEED REDUCTION THIS DIRECTION

<p>Michigan Department of Transportation</p> <p>TRAFFIC AND SAFETY</p> <p>MAINTAINING TRAFFIC TYPICAL</p>		<p>TYPICAL TEMPORARY TRAFFIC CONTROL FOR CLOSING ONE LANE OF A FIVE-LANE UNDIVIDED ROADWAY AND MAINTAINING TWO THROUGH LANES IN EACH DIRECTION USING A SINGLE STEP DOWN IN SPEED LIMIT IN ONE DIRECTION ONLY</p>	
<p>DRAWN BY: CON:AE:djf</p> <p>CHECKED BY: BMM:CRB</p>	<p>OCTOBER 2011</p> <p>PLAN DATE:</p>	<p>M0410a</p>	<p>SHEET 1 OF 2</p>
<p>FILE: K:\-DGN-TSR-STD5-ENGLISH-MNTTRF-M0410a.dgn</p>		<p>REV. 10/19/2011</p>	

NOT TO SCALE

NOTES

- 1F. D = DISTANCE BETWEEN TRAFFIC CONTROL DEVICES
1/2 L, AND 1/3 L = MINIMUM LENGTH OF TAPER
B = LENGTH OF LONGITUDINAL BUFFER
SEE M0020a FOR "D," "L," AND "B" VALUES
2. ALL NON-APPLICABLE SIGNING WITHIN THE CIA SHALL BE MODIFIED TO FIT CONDITIONS, COVERED OR REMOVED.
3. DISTANCES BETWEEN SIGNS, THE VALUES FOR WHICH ARE SHOWN IN TABLE D, ARE APPROXIMATE AND MAY NEED ADJUSTING AS DIRECTED BY THE ENGINEER.
- 3A. THE "WORK ZONE BEGINS" (R5-18c) SIGN SHALL BE USED ONLY IN THE INITIAL SIGNING SEQUENCE IN THE WORK ZONE. SUBSEQUENT SEQUENCES IN THE SAME WORK ZONE SHALL OMIT THIS SIGN AND THE QUANTITIES SHALL BE ADJUSTED APPROPRIATELY.
- 4E. THE MAXIMUM RECOMMENDED DISTANCE(S) BETWEEN CHANNELIZING DEVICES SHOULD BE EQUAL IN FEET TO THE POSTED SPEED IN MILES PER HOUR ON TAPER(S) AND TWICE THE POSTED SPEED IN THE PARALLEL AREA(S).
5. FOR OVERNIGHT CLOSURES, TYPE III BARRICADES SHALL BE LIGHTED.
6. THE TYPE A WARNING FLASHER SHOWN ON THE WARNING SIGNS SHALL BE POSITIONED ON THE SIDE OF THE SIGN NEAREST THE ROADWAY.
7. ALL TEMPORARY SIGNS, TYPE III BARRICADES, THEIR SUPPORT SYSTEMS AND LIGHTING REQUIREMENTS SHALL MEET NCHRP 350 CRASHWORTHLY REQUIREMENTS STIPULATED IN THE CURRENT EDITION OF THE MICHIGAN MANUAL ON UNIFORM TRAFFIC CONTROL DEVICES, THE CURRENT EDITION OF THE STANDARD SPECIFICATIONS FOR CONSTRUCTION, THE STANDARD PLANS AND APPLICABLE SPECIAL PROVISIONS. ONLY DESIGNS AND MATERIALS APPROVED BY MDOT WILL BE ALLOWED.
8. WHEN BUFFER AREAS ARE ESTABLISHED, THERE SHALL BE NO EQUIPMENT OR MATERIALS STORED OR WORK CONDUCTED IN THE BUFFER AREA.
- 16A. ADDITIONAL SPEED LIMIT SIGNS REFLECTING THE REDUCED SPEED SHALL BE PLACED AFTER EACH MAJOR CROSSROAD THAT INTERSECTS THE WORK AREA WHERE THE REDUCED SPEED IS IN EFFECT, AND AT INTERVALS ALONG THE ROADWAY SUCH THAT NO SPEED LIMIT SIGNS REFLECTING THE REDUCED SPEED ARE MORE THAN TWO MILES APART.
- 16B. WHEN REDUCED SPEED LIMITS ARE UTILIZED IN THE WORK AREA, ADDITIONAL SPEED LIMIT SIGNS RETURNING TRAFFIC TO ITS NORMAL SPEED SHALL BE PLACED BEYOND THE LIMITS OF THE REDUCED SPEED AS INDICATED.
- 16E. WHEN EXISTING SPEED LIMITS ARE REDUCED MORE THAN 10 MPH, THE SPEED LIMIT SHALL BE STEPPED DOWN IN NO MORE THAN 10 MPH INCREMENTS.
21. ALL EXISTING PAVEMENT MARKINGS WHICH ARE IN CONFLICT WITH EITHER PROPOSED CHANGES IN TRAFFIC PATTERNS OR PROPOSED TEMPORARY TRAFFIC MARKINGS, SHALL BE REMOVED BEFORE ANY CHANGE IS MADE IN THE TRAFFIC PATTERN. EXCEPTION WILL BE MADE FOR DAYTIME-ONLY TRAFFIC PATTERNS THAT ARE ADEQUATELY DELINEATED BY OTHER TRAFFIC CONTROL DEVICES.

SIGN SIZES

DIAMOND WARNING	- 48" x 48"
W1-6 WARNING	- 48" x 24"
RECTANGULAR REGULATORY	- 48" x 60"
R5-18c REGULATORY	- 48" x 48"

NOT TO SCALE

 TRAFFIC AND SAFETY MAINTAINING TRAFFIC TYPICAL	TYPICAL TEMPORARY TRAFFIC CONTROL FOR CLOSING ONE LANE OF A FIVE-LANE UNDIVIDED ROADWAY AND MAINTAINING TWO THROUGH LANES IN EACH DIRECTION USING A SINGLE STEP DOWN IN SPEED LIMIT IN ONE DIRECTION ONLY	
	DRAWN BY: CON:AE:djf	OCTOBER 2011
CHECKED BY: BMM:CRB	PLAN DATE:	SHEET 2 OF 2
FILE: K:\DGN-TSR-STD5-ENGLISH-MNTTRF-M0410a.dgn		REV. 10/19/2011

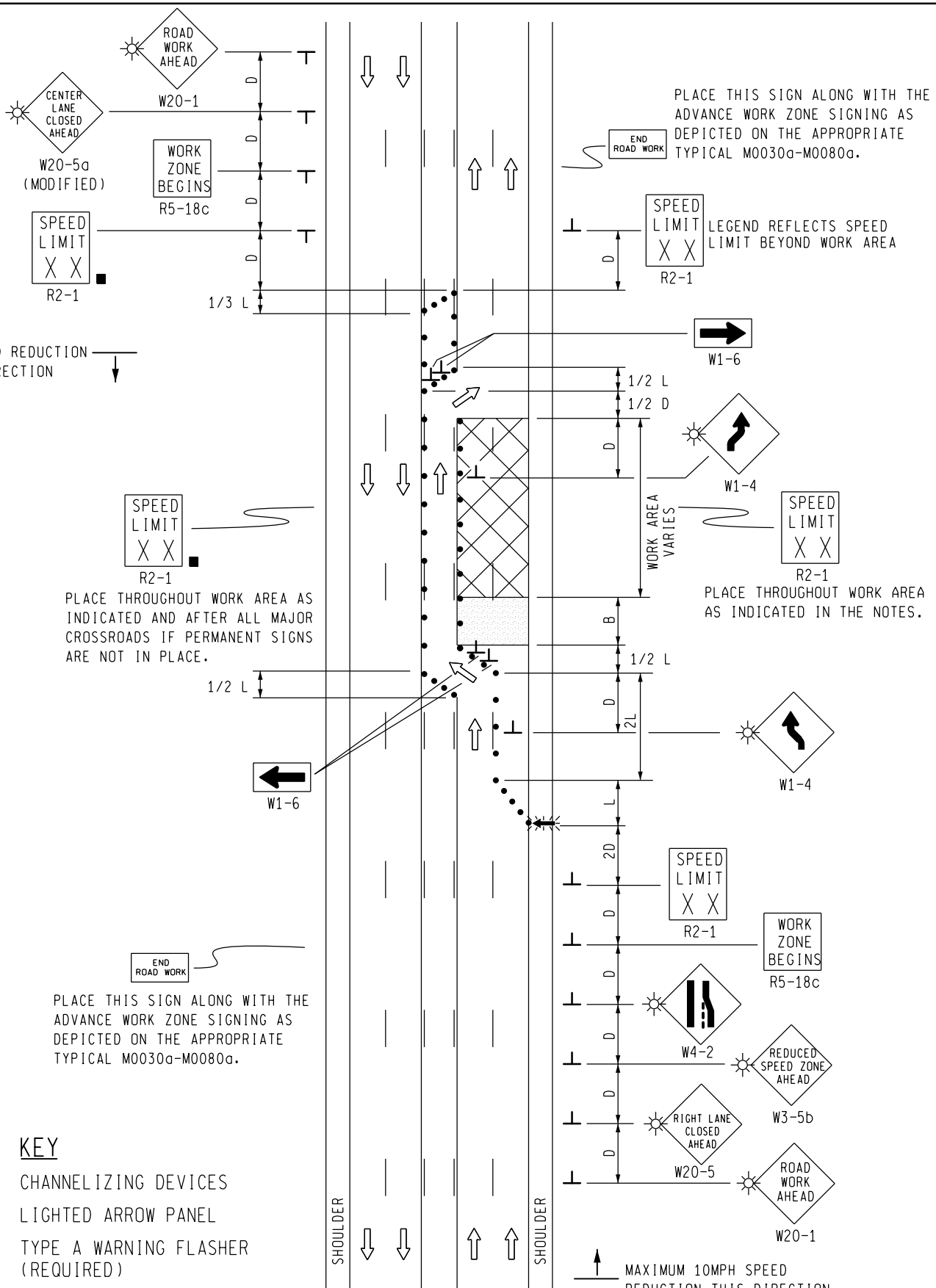

KEY

- • • CHANNELIZING DEVICES
- ← LIGHTED ARROW PANEL
- ☀ TYPE A WARNING FLASHER (REQUIRED)
- TRAFFIC FLOW
- REFLECTS EXISTING SPEED LIMIT

SIGN = 252 ft+2 - TYPE B PLUS ADDITIONAL R2-1's THROUGHOUT WORK AREA

NOT TO SCALE

MDOT
Michigan Department of Transportation
TRAFFIC AND SAFETY
MAINTAINING TRAFFIC
TYPICAL

TYPICAL TEMPORARY TRAFFIC CONTROL FOR CLOSING TWO ADJACENT THROUGH LANES OF A FIVE-LANE UNDIVIDED ROADWAY USING A SINGLE STEP DOWN IN SPEED LIMIT IN ONE DIRECTION ONLY

DRAWN BY: CON:AE:djf	OCTOBER 2011	M0440a	SHEET 1 OF 2
CHECKED BY: BMM:CRB	PLAN DATE:		
FILE: K:\DGN-TSR-STD5-ENGL\SH-MNTTRF-M0440a.dgn		REV.	10/20/2011

NOTES

- 1E. D = DISTANCE BETWEEN TRAFFIC CONTROL DEVICES
L, 1/2 L, AND 1/3 L = MINIMUM LENGTH OF TAPER
B = LENGTH OF LONGITUDINAL BUFFER
SEE **M0020a** FOR "D," "L," AND "B" VALUES
2. ALL NON-APPLICABLE SIGNING WITHIN THE CIA SHALL BE MODIFIED TO FIT CONDITIONS, COVERED OR REMOVED.
3. DISTANCES BETWEEN SIGNS, THE VALUES FOR WHICH ARE SHOWN IN TABLE D, ARE APPROXIMATE AND MAY NEED ADJUSTING AS DIRECTED BY THE ENGINEER.
- 3A. THE "WORK ZONE BEGINS" (R5-18c) SIGN SHALL BE USED ONLY IN THE INITIAL SIGNING SEQUENCE IN THE WORK ZONE. SUBSEQUENT SEQUENCES IN THE SAME WORK ZONE SHALL OMIT THIS SIGN AND THE QUANTITIES SHALL BE ADJUSTED APPROPRIATELY.
- 4E. THE MAXIMUM RECOMMENDED DISTANCE(S) BETWEEN CHANNELIZING DEVICES SHOULD BE EQUAL IN FEET TO THE POSTED SPEED IN MILES PER HOUR ON TAPER(S) AND TWICE THE POSTED SPEED IN THE PARALLEL AREA(S).
5. FOR OVERNIGHT CLOSURES, TYPE III BARRICADES SHALL BE LIGHTED.
6. THE TYPE A WARNING FLASHER SHOWN ON THE WARNING SIGNS SHALL BE POSITIONED ON THE SIDE OF THE SIGN NEAREST THE ROADWAY.
7. ALL TEMPORARY SIGNS, TYPE III BARRICADES, THEIR SUPPORT SYSTEMS AND LIGHTING REQUIREMENTS SHALL MEET NCHRP 350 CRASHWORTHY REQUIREMENTS STIPULATED IN THE CURRENT EDITION OF THE MICHIGAN MANUAL ON UNIFORM TRAFFIC CONTROL DEVICES, THE CURRENT EDITION OF THE STANDARD SPECIFICATIONS FOR CONSTRUCTION, THE STANDARD PLANS AND APPLICABLE SPECIAL PROVISIONS. ONLY DESIGNS AND MATERIALS APPROVED BY MDOT WILL BE ALLOWED.
8. WHEN BUFFER AREAS ARE ESTABLISHED, THERE SHALL BE NO EQUIPMENT OR MATERIALS STORED OR WORK CONDUCTED IN THE BUFFER AREA.
- 16A. ADDITIONAL SPEED LIMIT SIGNS REFLECTING THE REDUCED SPEED SHALL BE PLACED AFTER EACH MAJOR CROSSROAD THAT INTERSECTS THE WORK AREA WHERE THE REDUCED SPEED IS IN EFFECT, AND AT INTERVALS ALONG THE ROADWAY SUCH THAT NO SPEED LIMIT SIGNS REFLECTING THE REDUCED SPEED ARE MORE THAN TWO MILES APART.
- 16B. WHEN REDUCED SPEED LIMITS ARE UTILIZED IN THE WORK AREA, ADDITIONAL SPEED LIMIT SIGNS RETURNING TRAFFIC TO ITS NORMAL SPEED SHALL BE PLACED BEYOND THE LIMITS OF THE REDUCED SPEED AS INDICATED.
- 16E. WHEN EXISTING SPEED LIMITS ARE REDUCED MORE THAN 10 MPH, THE SPEED LIMIT SHALL BE STEPPED DOWN IN NO MORE THAN 10 MPH INCREMENTS.
21. ALL EXISTING PAVEMENT MARKINGS WHICH ARE IN CONFLICT WITH EITHER PROPOSED CHANGES IN TRAFFIC PATTERNS OR PROPOSED TEMPORARY TRAFFIC MARKINGS, SHALL BE REMOVED BEFORE ANY CHANGE IS MADE IN THE TRAFFIC PATTERN. EXCEPTION WILL BE MADE FOR DAYTIME-ONLY TRAFFIC PATTERNS THAT ARE ADEQUATELY DELINEATED BY OTHER TRAFFIC CONTROL DEVICES.
26. THE LIGHTED ARROW PANEL SHALL BE LOCATED AT THE BEGINNING OF THE TAPER AS SHOWN. WHEN PHYSICAL LIMITATIONS RESTRICT ITS PLACEMENT AS INDICATED, THEN IT SHALL BE PLACED AS CLOSE TO THE BEGINNING OF THE TAPER AS POSSIBLE.

SIGN SIZES

DIAMOND WARNING	- 48" x 48"
W1-6 WARNING	- 48" x 24"
RECTANGULAR REGULATORY	- 48" x 60"
R5-18c REGULATORY	- 48" x 48"

NOT TO SCALE

 TRAFFIC AND SAFETY MAINTAINING TRAFFIC TYPICAL	TYPICAL TEMPORARY TRAFFIC CONTROL FOR CLOSING TWO ADJACENT THROUGH LANES OF A FIVE-LANE UNDIVIDED ROADWAY USING A SINGLE STEP DOWN IN SPEED LIMIT IN ONE DIRECTION ONLY		
	DRAWN BY: CON:AE:djf	OCTOBER 2011	M0440a
CHECKED BY: BMM:CRB	PLAN DATE:	2 OF 2	
FILE: K:\DGN-TSR-STD5-ENGLISH-MNTTRF-M0440a.dgn		REV.	10/20/2011

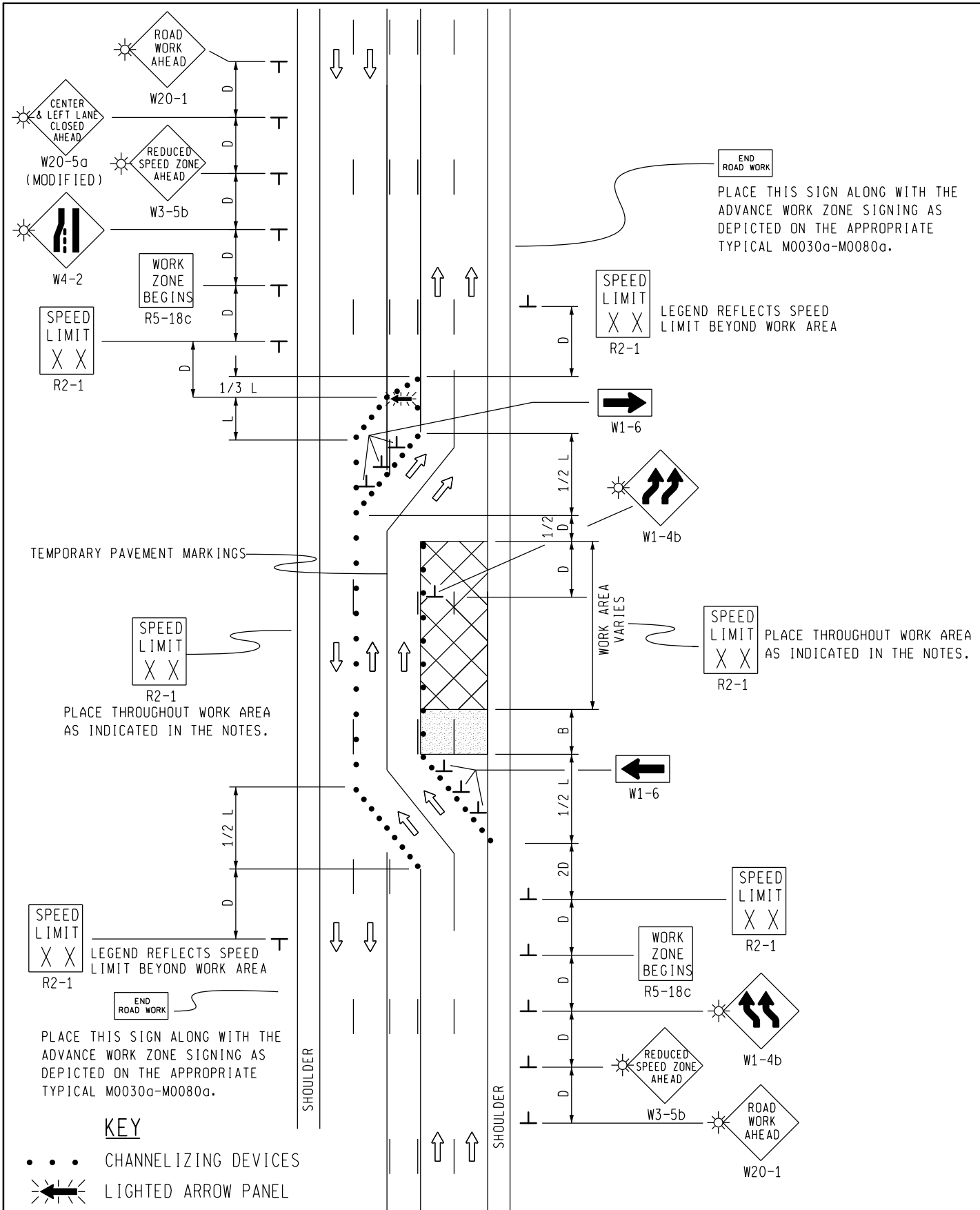

PLACE THIS SIGN ALONG WITH THE ADVANCE WORK ZONE SIGNING AS DEPICTED ON THE APPROPRIATE TYPICAL M0030a-M0080a.

LEGEND REFLECTS SPEED LIMIT BEYOND WORK AREA

PLACE THROUGHOUT WORK AREA AS INDICATED IN THE NOTES.

PLACE THROUGHOUT WORK AREA AS INDICATED IN THE NOTES.

LEGEND REFLECTS SPEED LIMIT BEYOND WORK AREA

PLACE THIS SIGN ALONG WITH THE ADVANCE WORK ZONE SIGNING AS DEPICTED ON THE APPROPRIATE TYPICAL M0030a-M0080a.

KEY

- • • CHANNELIZING DEVICES
- ← LIGHTED ARROW PANEL
- ☀ TYPE A WARNING FLASHER (REQUIRED)
- TRAFFIC FLOW

SIGN = 288 ft± - TYPE B PLUS ADDITIONAL R2-1's THROUGHOUT WORK AREA

NOT TO SCALE



TRAFFIC AND SAFETY
MAINTAINING TRAFFIC
TYPICAL

TYPICAL TEMPORARY TRAFFIC CONTROL FOR CLOSING TWO ADJACENT THROUGH LANES OF A FIVE-LANE UNDIVIDED ROADWAY USING A SINGLE STEP DOWN IN SPEED LIMIT

DRAWN BY: CON:AE:djf	OCTOBER 2011	M0470a	SHEET 1 OF 2
CHECKED BY: BMM:CRB	PLAN DATE:		
FILE: K:\DGN-TSR-STDS-ENGLISH-MNTTRF-M0470a.dgn		REV.	10/20/2011

NOTES

- 1E. D = DISTANCE BETWEEN TRAFFIC CONTROL DEVICES
L, 1/2 L, AND 1/3 L = MINIMUM LENGTH OF TAPER
B = LENGTH OF LONGITUDINAL BUFFER
SEE **M0020a** FOR "D," "L," AND "B" VALUES
2. ALL NON-APPLICABLE SIGNING WITHIN THE CIA SHALL BE MODIFIED TO FIT CONDITIONS, COVERED OR REMOVED.
3. DISTANCES BETWEEN SIGNS, THE VALUES FOR WHICH ARE SHOWN IN TABLE D, ARE APPROXIMATE AND MAY NEED ADJUSTING AS DIRECTED BY THE ENGINEER.
- 3A. THE "WORK ZONE BEGINS" (R5-18c) SIGN SHALL BE USED ONLY IN THE INITIAL SIGNING SEQUENCE IN THE WORK ZONE. SUBSEQUENT SEQUENCES IN THE SAME WORK ZONE SHALL OMIT THIS SIGN AND THE QUANTITIES SHALL BE ADJUSTED APPROPRIATELY.
- 4E. THE MAXIMUM RECOMMENDED DISTANCE(S) BETWEEN CHANNELIZING DEVICES SHOULD BE EQUAL IN FEET TO THE POSTED SPEED IN MILES PER HOUR ON TAPER(S) AND TWICE THE POSTED SPEED IN THE PARALLEL AREA(S).
5. FOR OVERNIGHT CLOSURES, TYPE III BARRICADES SHALL BE LIGHTED.
6. THE TYPE A WARNING FLASHER SHOWN ON THE WARNING SIGNS SHALL BE POSITIONED ON THE SIDE OF THE SIGN NEAREST THE ROADWAY.
7. ALL TEMPORARY SIGNS, TYPE III BARRICADES, THEIR SUPPORT SYSTEMS AND LIGHTING REQUIREMENTS SHALL MEET NCHRP 350 CRASHWORTHY REQUIREMENTS STIPULATED IN THE CURRENT EDITION OF THE MICHIGAN MANUAL ON UNIFORM TRAFFIC CONTROL DEVICES, THE CURRENT EDITION OF THE STANDARD SPECIFICATIONS FOR CONSTRUCTION, THE STANDARD PLANS AND APPLICABLE SPECIAL PROVISIONS. ONLY DESIGNS AND MATERIALS APPROVED BY MDOT WILL BE ALLOWED.
8. WHEN BUFFER AREAS ARE ESTABLISHED, THERE SHALL BE NO EQUIPMENT OR MATERIALS STORED OR WORK CONDUCTED IN THE BUFFER AREA.
- 16A. ADDITIONAL SPEED LIMIT SIGNS REFLECTING THE REDUCED SPEED SHALL BE PLACED AFTER EACH MAJOR CROSSROAD THAT INTERSECTS THE WORK AREA WHERE THE REDUCED SPEED IS IN EFFECT, AND AT INTERVALS ALONG THE ROADWAY SUCH THAT NO SPEED LIMIT SIGNS REFLECTING THE REDUCED SPEED ARE MORE THAN TWO MILES APART.
- 16B. WHEN REDUCED SPEED LIMITS ARE UTILIZED IN THE WORK AREA, ADDITIONAL SPEED LIMIT SIGNS RETURNING TRAFFIC TO ITS NORMAL SPEED SHALL BE PLACED BEYOND THE LIMITS OF THE REDUCED SPEED AS INDICATED.
- 16E. WHEN EXISTING SPEED LIMITS ARE REDUCED MORE THAN 10 MPH, THE SPEED LIMIT SHALL BE STEPPED DOWN IN NO MORE THAN 10 MPH INCREMENTS.
21. ALL EXISTING PAVEMENT MARKINGS WHICH ARE IN CONFLICT WITH EITHER PROPOSED CHANGES IN TRAFFIC PATTERNS OR PROPOSED TEMPORARY TRAFFIC MARKINGS, SHALL BE REMOVED BEFORE ANY CHANGE IS MADE IN THE TRAFFIC PATTERN. EXCEPTION WILL BE MADE FOR DAYTIME-ONLY TRAFFIC PATTERNS THAT ARE ADEQUATELY DELINEATED BY OTHER TRAFFIC CONTROL DEVICES.
- 26C. THE LIGHTED ARROW PANEL SHALL BE LOCATED AT THE BEGINNING OF THE MERGING TAPER AS SHOWN. WHEN PHYSICAL LIMITATIONS RESTRICT ITS PLACEMENT AS INDICATED, THEN IT SHALL BE PLACED AS CLOSE TO THE BEGINNING OF THE MERGING TAPER AS POSSIBLE.

SIGN SIZES

DIAMOND WARNING	- 48" x 48"
W1-6 WARNING	- 48" x 24"
RECTANGULAR REGULATORY	- 48" x 60"
R5-18c REGULATORY	- 48" x 48"

NOT TO SCALE

 TRAFFIC AND SAFETY MAINTAINING TRAFFIC TYPICAL	TYPICAL TEMPORARY TRAFFIC CONTROL FOR CLOSING TWO ADJACENT THROUGH LANES OF A FIVE-LANE UNDIVIDED ROADWAY USING A SINGLE STEP DOWN IN SPEED LIMIT	
	DRAWN BY: CON:AE:djf	OCTOBER 2011
CHECKED BY: BMM:CRB	PLAN DATE:	SHEET 2 OF 2
FILE: K:\DGN-TSR-STD5-ENGLISH-MNTTRF-M0470a.dgn		REV. 10/20/2011

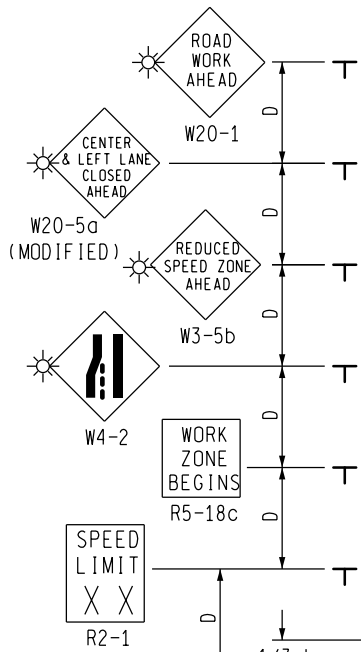

PLACE THIS SIGN ALONG WITH THE ADVANCE WORK ZONE SIGNING AS DEPICTED ON THE APPROPRIATE TYPICAL M0030a-M0080a.



PLACE THROUGHOUT WORK AREA AS INDICATED IN THE NOTES.

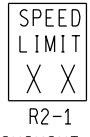

PLACE THROUGHOUT WORK AREA AS INDICATED IN THE NOTES.

LEGEND REFLECTS SPEED LIMIT BEYOND WORK AREA



KEY

- • • CHANNELIZING DEVICES
- ← LIGHTED ARROW PANEL
- ☀ TYPE A WARNING FLASHER (REQUIRED)
- ⇒ TRAFFIC FLOW

SIGN = 320 ft± - TYPE B PLUS ADDITIONAL R2-1's THROUGHOUT WORK AREA

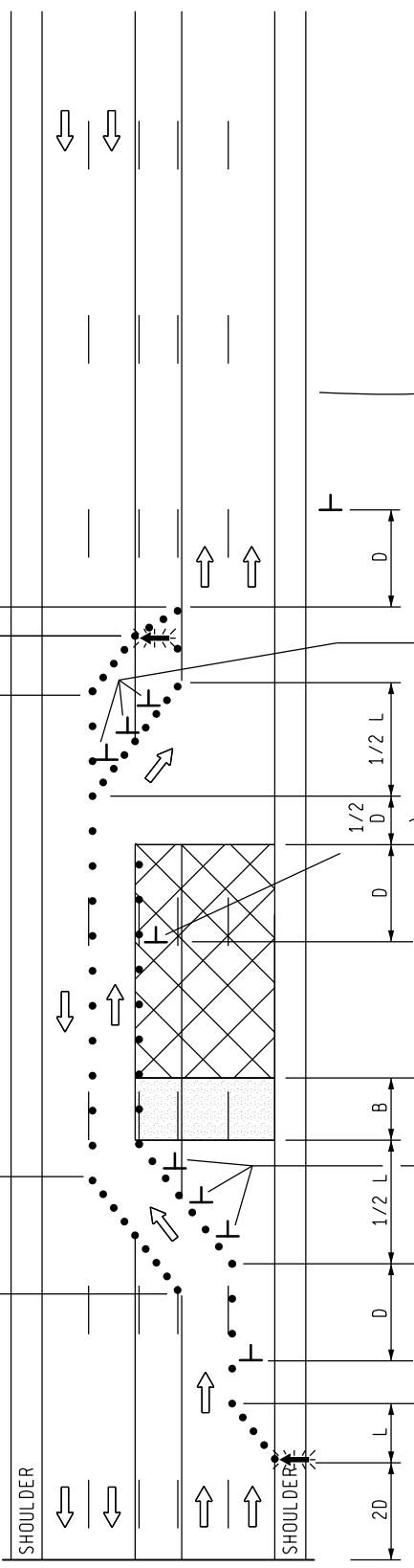

A MATCH A

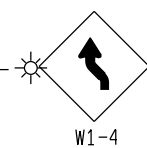
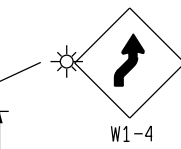

<p>TRAFFIC AND SAFETY MAINTAINING TRAFFIC TYPICAL</p>		TYPICAL TEMPORARY TRAFFIC CONTROL FOR CLOSING THREE LANES OF A FIVE-LANE UNDIVIDED ROADWAY USING A SINGLE STEP DOWN IN SPEED LIMIT	
		DRAWN BY: CON:AE:djf CHECKED BY: BMM:CRB	OCTOBER 2011 PLAN DATE:
NOT TO SCALE		FILE: K:\-DGN-TSR-STDS-ENGLISH-MNTTRF-M0500a.dgn REV. 10/20/2011	

A MATCH A

END ROAD WORK
 PLACE THIS SIGN ALONG WITH THE ADVANCE WORK ZONE SIGNING AS DEPICTED ON THE APPROPRIATE TYPICAL M0030a-M0080a.

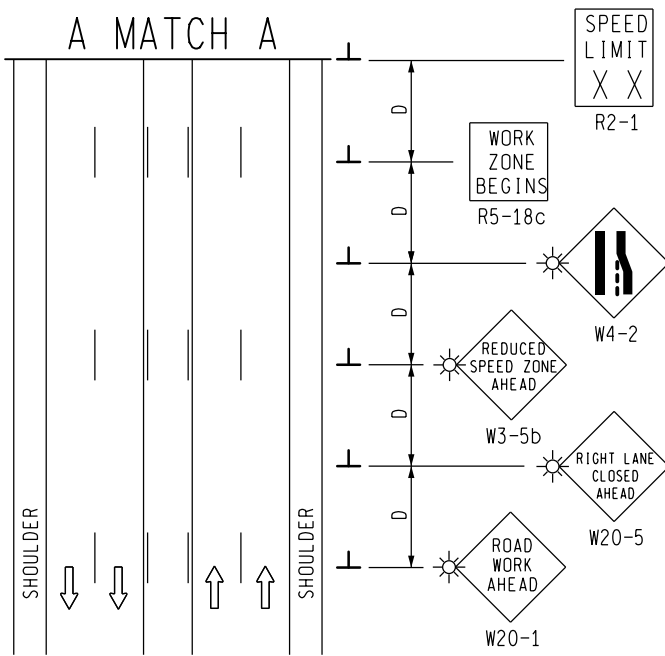

<p>TRAFFIC AND SAFETY MAINTAINING TRAFFIC TYPICAL</p>	TYPICAL TEMPORARY TRAFFIC CONTROL FOR CLOSING THREE LANES OF A FIVE-LANE UNDIVIDED ROADWAY USING A SINGLE STEP DOWN IN SPEED LIMIT	
	DRAWN BY: CON:AE:djf CHECKED BY: BMM:CRB	OCTOBER 2011 PLAN DATE:
FILE: K:-DGN-TSR-STDS-ENGLISH-MNTTRF-M0500a.dgn REV. 10/20/2011		

NOT TO SCALE

NOTES

- 1E. D = DISTANCE BETWEEN TRAFFIC CONTROL DEVICES
L, 1/2 L, AND 1/3 L = MINIMUM LENGTH OF TAPER
B = LENGTH OF LONGITUDINAL BUFFER
SEE **M0020a** FOR "D," "L," AND "B" VALUES
2. ALL NON-APPLICABLE SIGNING WITHIN THE CIA SHALL BE MODIFIED TO FIT CONDITIONS, COVERED OR REMOVED.
3. DISTANCES BETWEEN SIGNS, THE VALUES FOR WHICH ARE SHOWN IN TABLE D, ARE APPROXIMATE AND MAY NEED ADJUSTING AS DIRECTED BY THE ENGINEER.
- 3A. THE "WORK ZONE BEGINS" (R5-18c) SIGN SHALL BE USED ONLY IN THE INITIAL SIGNING SEQUENCE IN THE WORK ZONE. SUBSEQUENT SEQUENCES IN THE SAME WORK ZONE SHALL OMIT THIS SIGN AND THE QUANTITIES SHALL BE ADJUSTED APPROPRIATELY.
- 4E. THE MAXIMUM RECOMMENDED DISTANCE(S) BETWEEN CHANNELIZING DEVICES SHOULD BE EQUAL IN FEET TO THE POSTED SPEED IN MILES PER HOUR ON TAPER(S) AND TWICE THE POSTED SPEED IN THE PARALLEL AREA(S).
5. FOR OVERNIGHT CLOSURES, TYPE III BARRICADES SHALL BE LIGHTED.
6. THE TYPE A WARNING FLASHER SHOWN ON THE WARNING SIGNS SHALL BE POSITIONED ON THE SIDE OF THE SIGN NEAREST THE ROADWAY.
7. ALL TEMPORARY SIGNS, TYPE III BARRICADES, THEIR SUPPORT SYSTEMS AND LIGHTING REQUIREMENTS SHALL MEET NCHRP 350 CRASHWORTHLY REQUIREMENTS STIPULATED IN THE CURRENT EDITION OF THE MICHIGAN MANUAL ON UNIFORM TRAFFIC CONTROL DEVICES, THE CURRENT EDITION OF THE STANDARD SPECIFICATIONS FOR CONSTRUCTION, THE STANDARD PLANS AND APPLICABLE SPECIAL PROVISIONS. ONLY DESIGNS AND MATERIALS APPROVED BY MDOT WILL BE ALLOWED.
8. WHEN BUFFER AREAS ARE ESTABLISHED, THERE SHALL BE NO EQUIPMENT OR MATERIALS STORED OR WORK CONDUCTED IN THE BUFFER AREA.
- 16A. ADDITIONAL SPEED LIMIT SIGNS REFLECTING THE REDUCED SPEED SHALL BE PLACED AFTER EACH MAJOR CROSSROAD THAT INTERSECTS THE WORK AREA WHERE THE REDUCED SPEED IS IN EFFECT, AND AT INTERVALS ALONG THE ROADWAY SUCH THAT NO SPEED LIMIT SIGNS REFLECTING THE REDUCED SPEED ARE MORE THAN TWO MILES APART.
- 16B. WHEN REDUCED SPEED LIMITS ARE UTILIZED IN THE WORK AREA, ADDITIONAL SPEED LIMIT SIGNS RETURNING TRAFFIC TO ITS NORMAL SPEED SHALL BE PLACED BEYOND THE LIMITS OF THE REDUCED SPEED AS INDICATED.
- 16E. WHEN EXISTING SPEED LIMITS ARE REDUCED MORE THAN 10 MPH, THE SPEED LIMIT SHALL BE STEPPED DOWN IN NO MORE THAN 10 MPH INCREMENTS.
21. ALL EXISTING PAVEMENT MARKINGS WHICH ARE IN CONFLICT WITH EITHER PROPOSED CHANGES IN TRAFFIC PATTERNS OR PROPOSED TEMPORARY TRAFFIC MARKINGS, SHALL BE REMOVED BEFORE ANY CHANGE IS MADE IN THE TRAFFIC PATTERN. EXCEPTION WILL BE MADE FOR DAYTIME-ONLY TRAFFIC PATTERNS THAT ARE ADEQUATELY DELINEATED BY OTHER TRAFFIC CONTROL DEVICES.
- 26C. THE LIGHTED ARROW PANEL SHALL BE LOCATED AT THE BEGINNING OF THE MERGING TAPER AS SHOWN. WHEN PHYSICAL LIMITATIONS RESTRICT ITS PLACEMENT AS INDICATED, THEN IT SHALL BE PLACED AS CLOSE TO THE BEGINNING OF THE MERGING TAPER AS POSSIBLE.

SIGN SIZES

DIAMOND WARNING	- 48" x 48"
W1-6 WARNING	- 48" x 24"
RECTANGULAR REGULATORY	- 48" x 60"
R5-18c REGULATORY	- 48" x 48"

NOT TO SCALE

 TRAFFIC AND SAFETY MAINTAINING TRAFFIC TYPICAL	TYPICAL TEMPORARY TRAFFIC CONTROL FOR CLOSING THREE LANES OF A FIVE-LANE UNDIVIDED ROADWAY USING A SINGLE STEP DOWN IN SPEED LIMIT		
	DRAWN BY: CON:AE:djf	OCTOBER 2011	M0500a
CHECKED BY: BMM:CRB	PLAN DATE:	3 OF 3	
FILE: K:\DGN-TSR-STD5-ENGLISH-MNTTRF-M0500a.dgn		REV.	10/20/2011

SIGN MATERIAL SELECTION TABLE

SIGN SIZE	SIGN MATERIAL TYPE		
	TYPE I	TYPE II	TYPE III
≤ 36" X 36"		X	X
>36" X 36" ≤ 96" TO WIDE		X	
> 96" WIDE TO 144" WIDE	X	X	
> 144" WIDE	X		

TYPE I ALUMINUM EXTRUSION
 TYPE II PLYWOOD
 TYPE III ALUMINUM SHEET

ROUNDING OF CORNERS IS NOT REQUIRED FOR TYPE I OR II SIGNS.
 VERTICAL JOINTS ARE NOT PERMITTED.
 HORIZONTAL JOINTS THROUGH SIGN LEGEND OR SYMBOLS ARE NOT PERMITTED.

POST SIZE REQUIREMENTS TABLE

SIGN AREA (ft ²)	POST TYPE		
	U-CHANNEL STEEL	SQUARE TUBULAR STEEL	WOOD
≤ 9	1 - 3 lb/ft*	1 - 2" 12 or 14 GA*	N/A
9 ≤ 20	2 - 3 lb/ft	2 - 2" 12 or 14 GA	1 - 4" X 6"*
> 20 ≤ 30	N/A	N/A	2 - 4" X 6"
> 30 ≤ 60	N/A	N/A	2 - 6" X 8"
> 60 ≤ 84	N/A	N/A	3 - 6" X 8"

*SIGNS 4 FEET AND GREATER IN WIDTH REQUIRE 2 POSTS.
 SIGNS GREATER THAN 8 FEET IN WIDTH REQUIRE 2 OR 3 WOOD
 POSTS DEPENDING ON AREA OF SIGN.
 A MAXIMUM OF 2 POSTS WITHIN A 7' PATH IS PERMITTED.

 PREPARED BY DESIGN DIVISION	DEPARTMENT DIRECTOR Kirk T. Steudle APPROVED BY: _____ DIRECTOR, BUREAU OF FIELD SERVICES	MICHIGAN DEPARTMENT OF TRANSPORTATION BUREAU OF DEVELOPMENT STANDARD PLAN FOR GROUND DRIVEN SIGN SUPPORTS FOR TEMP SIGNS		
	DRAWN BY: CON/ECH CHECKED BY: AUG	APPROVED BY: _____ DIRECTOR, BUREAU OF DEVELOPMENT	_____ F.H.W.A. APPROVAL	11/2/2017 PLAN DATE

2 POST SIGN SUPPORT SPACING

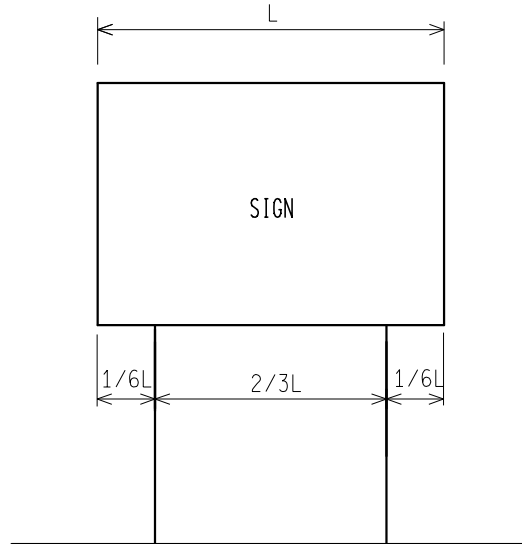

3 POST SIGN SUPPORT SPACING

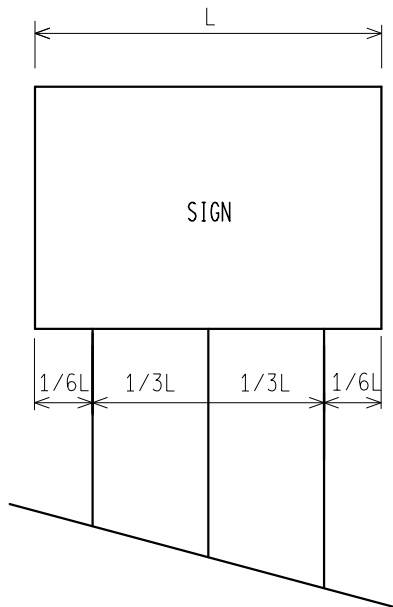

* FOR ALL 11' AND 12' LONG SIGNS ON 3 WOOD SUPPORTS, SPREAD POSTS SO AS TO HAVE A 8' MIN. TO 9' MAX. DISTANCE BETWEEN OUTSIDE POSTS.

NOT TO SCALE

MICHIGAN DEPARTMENT OF TRANSPORTATION
BUREAU OF DEVELOPMENT STANDARD PLAN

F.H.W.A. APPROVAL

11/2/2017
PLAN DATE

WZD-100-A

SHEET
2 OF 11

NOTE: THE ORIGINAL SIGNED COPY IS KEPT ON FILE AT THE MICHIGAN DEPARTMENT OF TRANSPORTATION.

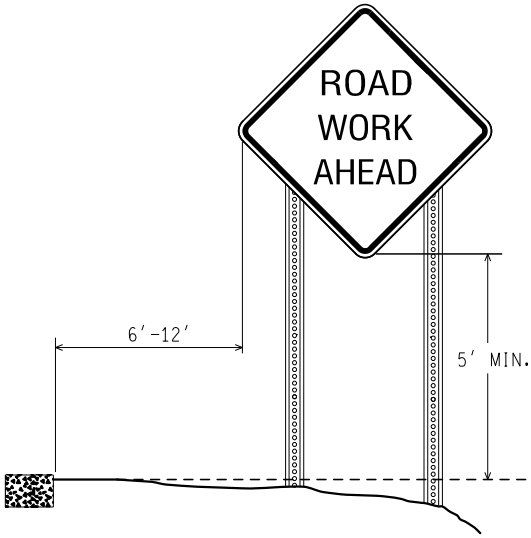

RURAL

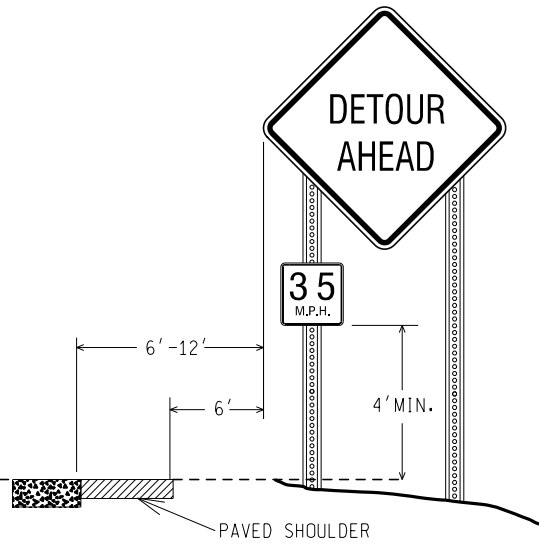

RURAL WITH ADVISORY SPEED PLATE

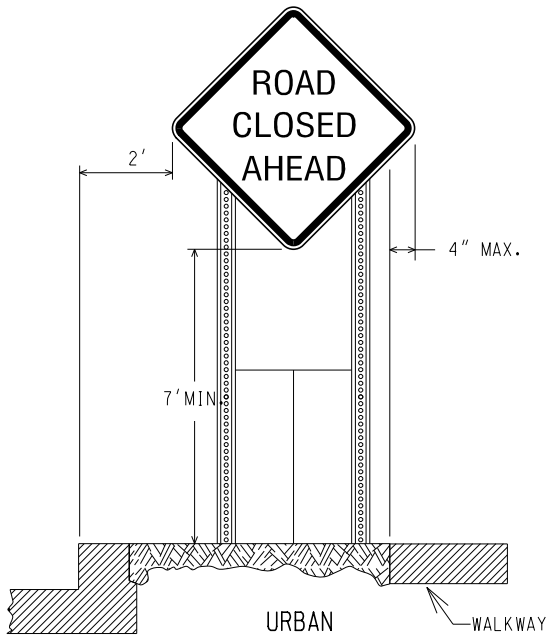

(CURBED AREAS OR WHERE WALKWAYS ARE PRESENT)

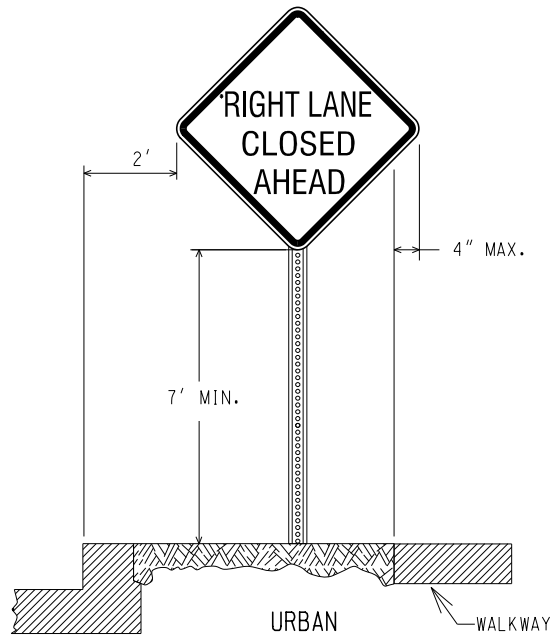

(CURBED AREAS OR WHERE WALKWAYS ARE PRESENT)

BOTTOM HEIGHT AND OFFSET

NOT TO SCALE

MICHIGAN DEPARTMENT OF TRANSPORTATION
BUREAU OF DEVELOPMENT STANDARD PLAN

F.H.W.A. APPROVAL

11/2/2017
PLAN DATE

WZD-100-A

SHEET
3 OF 11

NOTE: THE ORIGINAL SIGNED COPY IS KEPT ON FILE AT THE MICHIGAN DEPARTMENT OF TRANSPORTATION.

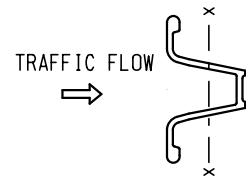
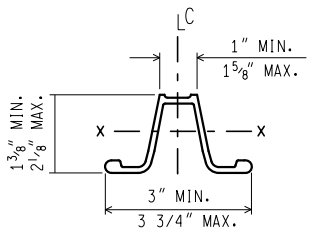
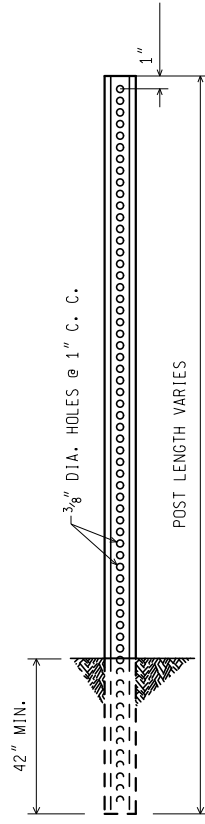

WEIGHT = 3 lbs/ft
 SECT. MOD. X.-X. = 0.31 CUBIC INCHES MIN.

3 lb. U - CHANNEL STEEL POST
 (NO SPLICE)

MOUNT SIGN ON OPEN FACE OF
 U - CHANNEL STEEL POST

NOT TO SCALE

MICHIGAN DEPARTMENT OF TRANSPORTATION BUREAU OF DEVELOPMENT STANDARD PLAN	F.H.W.A. APPROVAL	11/2/2017 PLAN DATE	WZD-100-A	SHEET 4 OF 11
--	-------------------	------------------------	-----------	------------------

NOTE: THE ORIGINAL SIGNED COPY IS KEPT ON FILE AT THE MICHIGAN DEPARTMENT OF TRANSPORTATION.

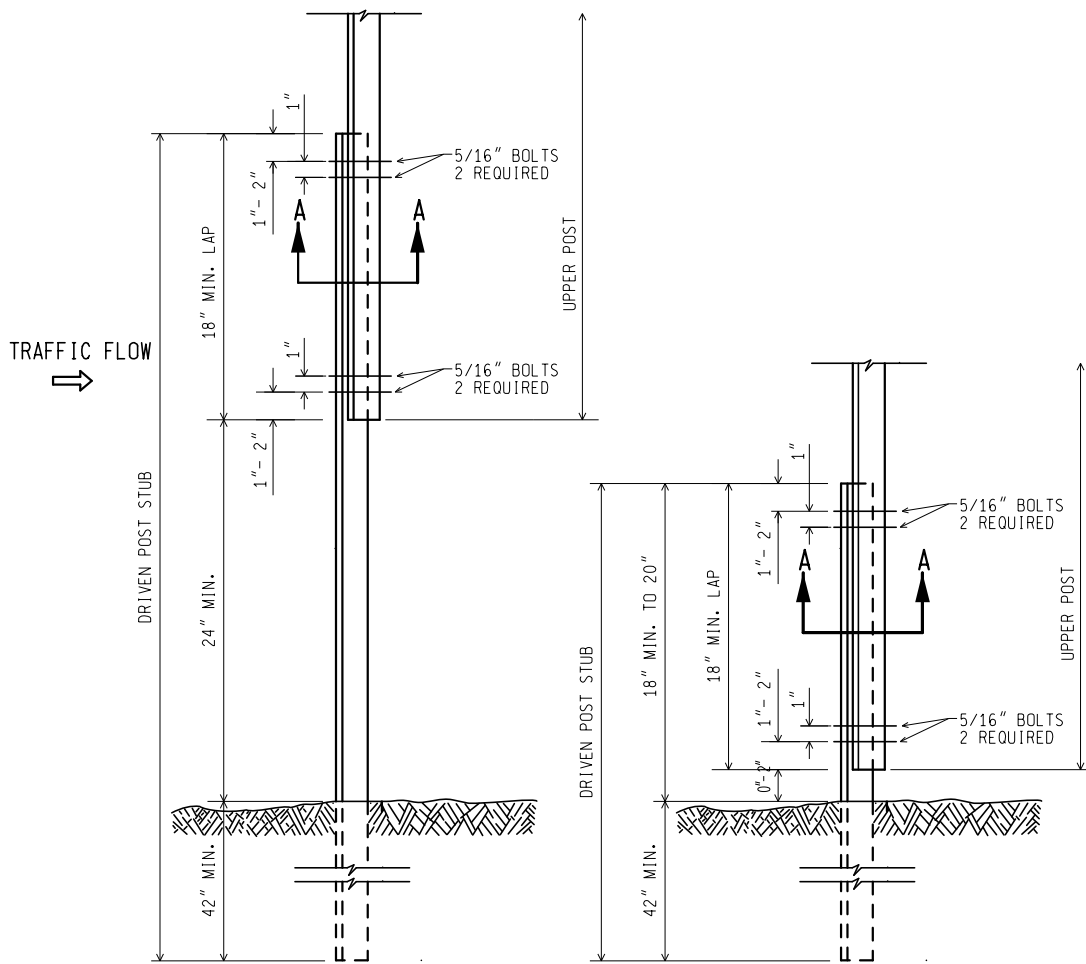

3 lb. U - CHANNEL STEEL POST
(WITH SPLICE)

MOUNT SIGN ON OPEN FACE OF
UPPER U - CHANNEL STEEL POST

NOT TO SCALE

MICHIGAN DEPARTMENT OF TRANSPORTATION BUREAU OF DEVELOPMENT STANDARD PLAN	F.H.W.A. APPROVAL	11/2/2017 PLAN DATE	WZD-100-A	SHEET 5 OF 11
--	-------------------	------------------------	-----------	------------------

NOTE: THE ORIGINAL SIGNED COPY IS KEPT ON FILE AT THE MICHIGAN DEPARTMENT OF TRANSPORTATION.

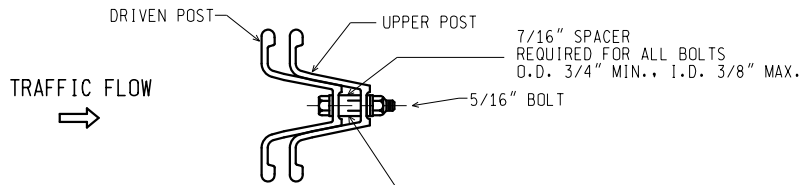

SECTION A-A

7/16" SPACER
 REQUIRED FOR ALL BOLTS
 O.D. 3/4" MIN., I.D. 3/8" MAX.

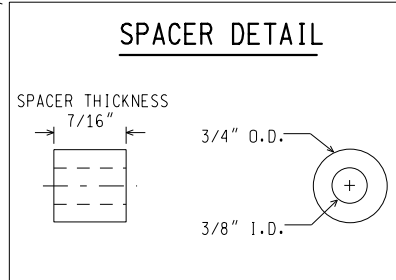

NOTES:

1. THE SPACER THICKNESS SHALL BE 1/16" LESS THAN THE GAP BETWEEN THE POST WHEN POSITIONED IN THE UNBOLTED CONFIGURATION.
2. THE EXTERIOR BOLT (CLOSEST TO LAP), SPACER, WASHER, AND NUT SHALL BE INSTALLED IN A PREPUNCHED HOLE 1" TO 2" FROM THE END OF THE LAP.
3. THE INTERIOR BOLT (FARTHEST FROM LAP), SPACER, WASHER, AND NUT SHALL BE INSTALLED IN THE NEXT PREPUNCHED HOLE.
4. THE DRIVEN POST SHALL ALWAYS BE MOUNTED IN FRONT OF THE UPPER POST WITH RESPECT TO THE ADJACENT ONCOMING TRAFFIC, REGARDLESS OF THE DIRECTION THE SIGN IS FACING.
5. THE SPLICE LAP SHALL BE FASTENED BY FOUR-5/16" DIA. GALVANIZED A449 BOLTS (SAE J429 GRADE 5) OR GALVANIZED A325 BOLTS.

3 lb. U - CHANNEL STEEL POST
 (WITH SPLICE)

NOT TO SCALE

MICHIGAN DEPARTMENT OF TRANSPORTATION BUREAU OF DEVELOPMENT STANDARD PLAN	F.H.W.A. APPROVAL	11/2/2017 PLAN DATE	WZD-100-A	SHEET 6 OF 11
--	-------------------	------------------------	-----------	------------------

NOTE: THE ORIGINAL SIGNED COPY IS KEPT ON FILE AT THE MICHIGAN DEPARTMENT OF TRANSPORTATION.

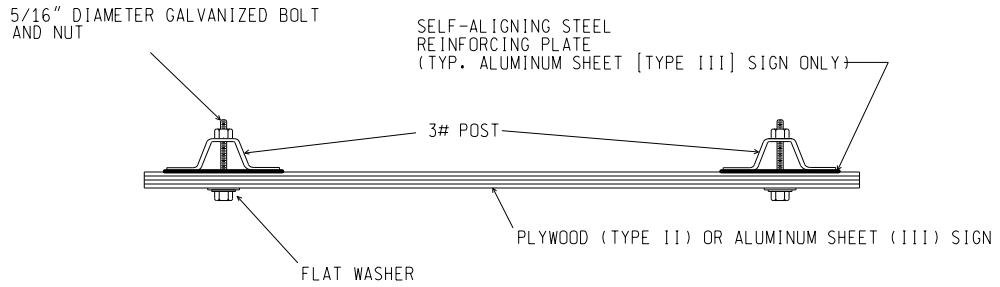

SIGN TO 3 lb. POST CONNECTION

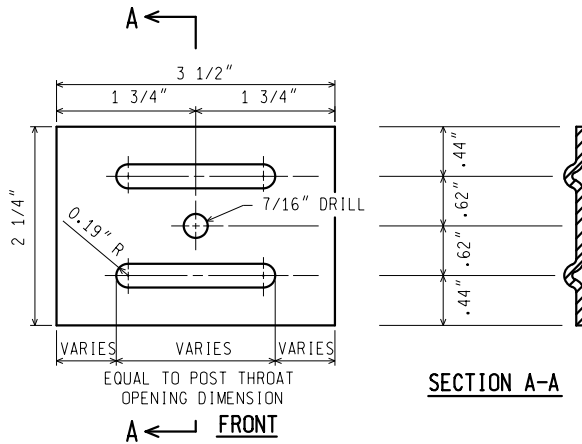

NOTES: (FOR STEEL SIGN REINF' PLATE)

1. MATERIAL: 12 GAUGE CARBON STEEL.
2. TOLERANCE ON ALL DIMENSIONS $\pm 0.0625"$
3. FINISH-AFTER STAMPING AND PUNCHING, GALVANIZE ACCORDING TO CURRENT SPECIFICATIONS FOR ZINC (HOT GALVANIZE) COATINGS ON PRODUCTS FABRICATED FROM PLATES OR STRIPS

STEEL SIGN REINFORCING PLATE
REQUIRED FOR TYPE III SIGNS ONLY

3 lb. U - CHANNEL STEEL POST SIGN CONNECTION

NOT TO SCALE

MICHIGAN DEPARTMENT OF TRANSPORTATION
BUREAU OF DEVELOPMENT STANDARD PLAN

F.H.W.A. APPROVAL

11/2/2017
PLAN DATE

WZD-100-A

SHEET
7 OF 11

NOTE: THE ORIGINAL SIGNED COPY IS KEPT ON FILE AT THE MICHIGAN DEPARTMENT OF TRANSPORTATION.

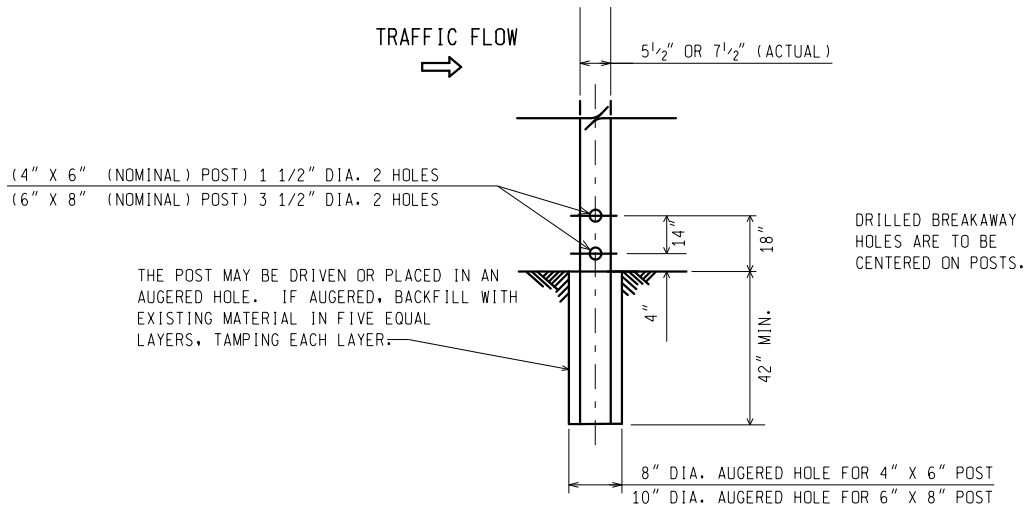

**WOOD POST BREAKAWAY HOLES/
 DIRECT EMBEDMENT DETAILS**

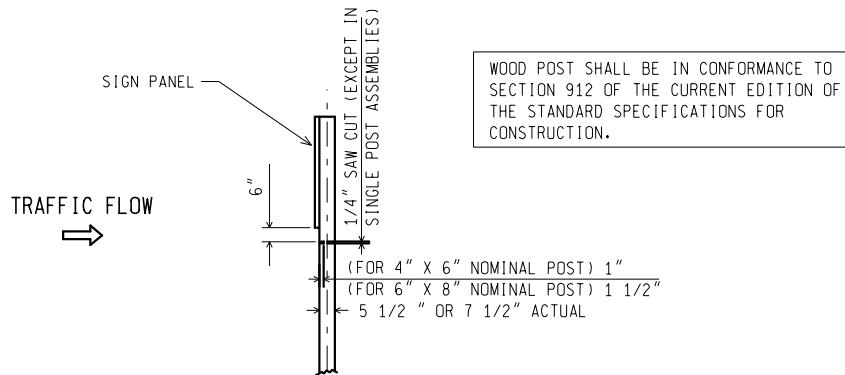

**SAW CUT DETAIL
 (MULTIPLE POST INSTALLATIONS)**

WOOD POST DETAILS

NOT TO SCALE

MICHIGAN DEPARTMENT OF TRANSPORTATION
 BUREAU OF DEVELOPMENT STANDARD PLAN

F.H.W.A. APPROVAL

11/2/2017
 PLAN DATE

WZD-100-A

SHEET
 8 OF 11

NOTE: THE ORIGINAL SIGNED COPY IS KEPT ON FILE AT THE MICHIGAN DEPARTMENT OF TRANSPORTATION.

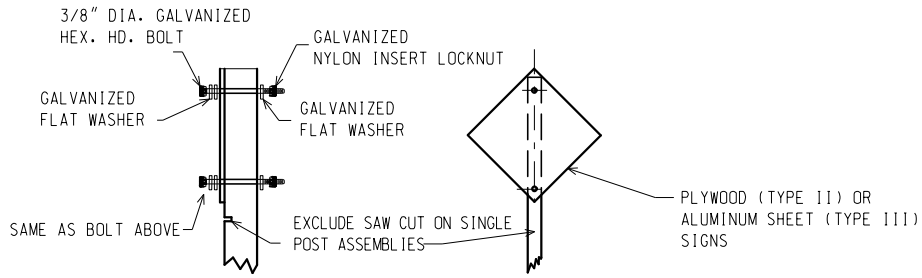

TYPE II AND TYPE III SIGNS

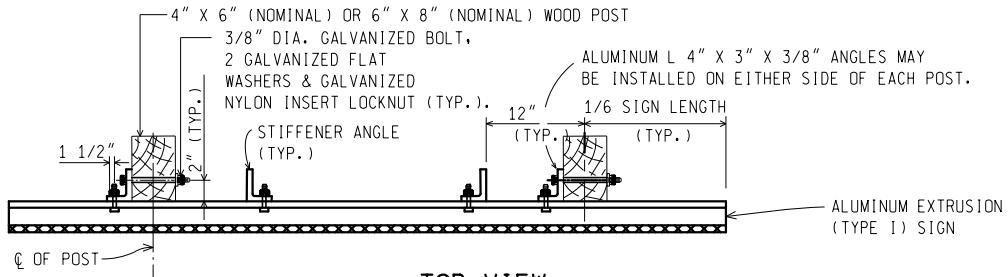

**TOP VIEW
TYPE I SIGN**

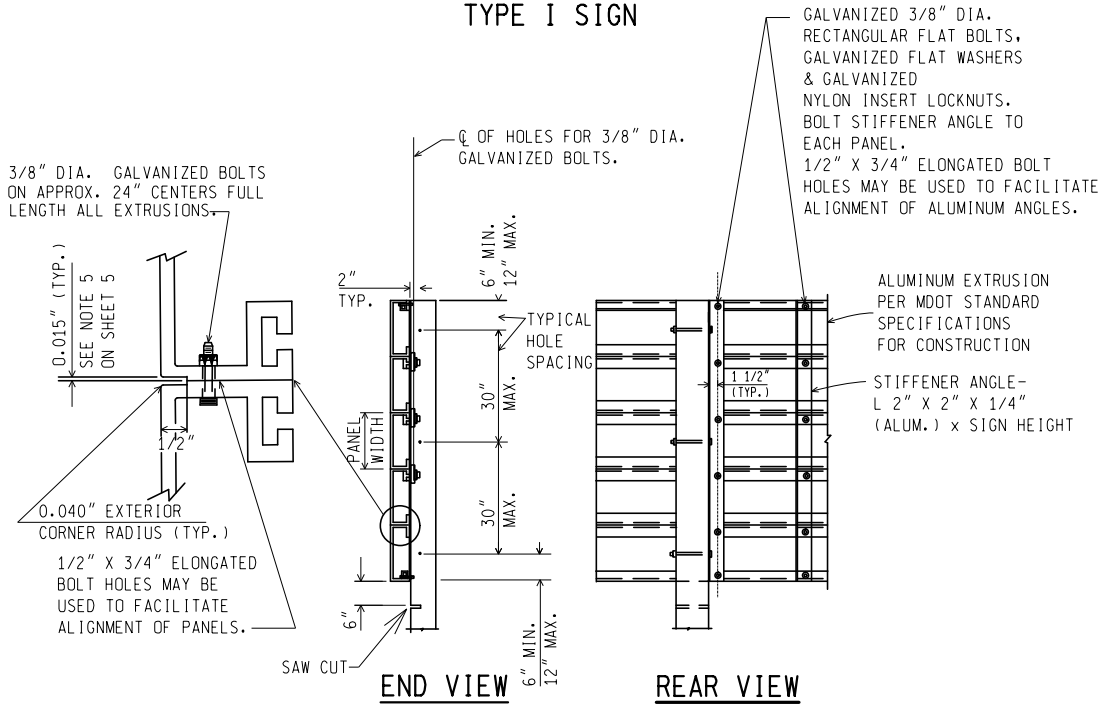

TYPE I SIGN - ERECTION DETAILS

WOOD POST CONNECTIONS

NOT TO SCALE

MICHIGAN DEPARTMENT OF TRANSPORTATION
BUREAU OF DEVELOPMENT STANDARD PLAN

F.H.W.A. APPROVAL

11/2/2017
PLAN DATE

WZD-100-A

SHEET
9 OF 11

NOTE: THE ORIGINAL SIGNED COPY IS KEPT ON FILE AT THE MICHIGAN DEPARTMENT OF TRANSPORTATION.

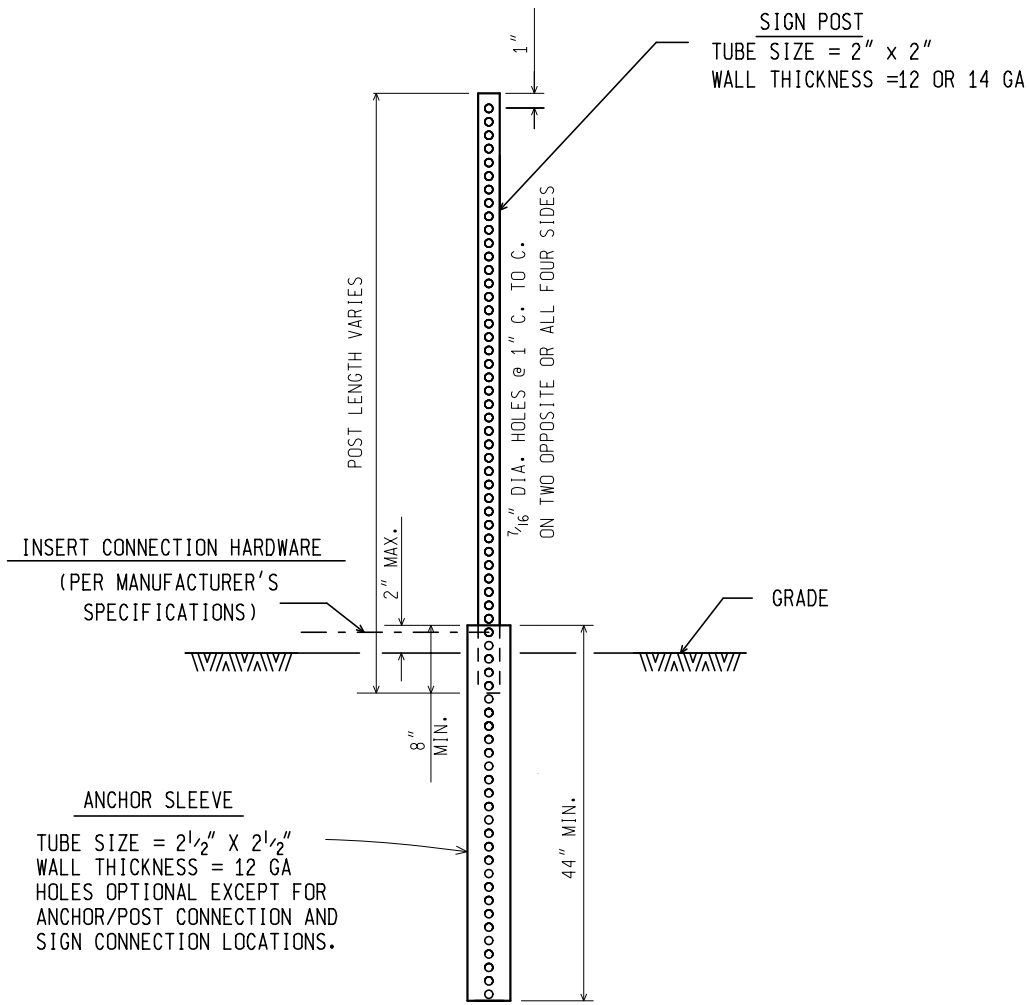

SQUARE TUBULAR STEEL POST

NOT TO SCALE

MICHIGAN DEPARTMENT OF TRANSPORTATION BUREAU OF DEVELOPMENT STANDARD PLAN	F.H.W.A. APPROVAL	11/2/2017 PLAN DATE	WZD-100-A	SHEET 10 OF 11
--	-------------------	------------------------	-----------	-------------------

NOTE: THE ORIGINAL SIGNED COPY IS KEPT ON FILE AT THE MICHIGAN DEPARTMENT OF TRANSPORTATION.

GENERAL NOTES:

1. A MAXIMUM OF TWO POSTS WITHIN A 7 FOOT PATH IS PERMITTED.
2. ALL SIGN POSTS SHALL COMPLY WITH NCHRP 350.
3. ALL POSTS SHALL BE EMBEDDED A MINIMUM OF 42".
4. BRACING OF POST IS NOT PERMITTED.
5. SIGN SHALL BE LEVEL, AND UPRIGHT FOR THE DURATION OF INSTALLATION.
6. ERECT POSTS SO THE SIGN FACE AND SUPPORTS DO NOT VARY FROM PLUMB BY MORE THAN 3/16" IN 3'. PROVIDE A CENTER-TO-CENTER DISTANCE BETWEEN POSTS WITHIN 2 PERCENT OF PLAN DISTANCE.
7. NO MORE THAN ONE SPLICE PER POST, AS SHOWN, WILL BE PERMITTED.
8. POST TYPES SHALL NOT BE MIXED WITHIN A SIGN SUPPORT INSTALLATION.
9. NO VERTICAL JOINTS ARE PERMITTED IN SIGN. NO HORIZONTAL JOINTS THROUGH SIGN LEGEND OR SYMBOLS ARE PERMITTED IN SIGN
10. REMOVE SIGN POSTS AND/OR POST STUBS IN THEIR ENTIRETY WHEN NO LONGER REQUIRED.
11. ALL LABOR, MATERIALS, AND EQUIPMENT, INCLUDING TEMPORARY SUPPORTS REQUIRED TO INSTALL, MAINTAIN, RELOCATE, AND/OR REMOVE THE TEMPORARY SIGN, INCLUDING SUPPORTS, ARE CONSIDERED TO BE INCLUDED IN THE COST OF THE TEMPORARY SIGN.
12. SAW CUTS IN WOOD POSTS ARE TO BE PARALLEL TO THE BOTTOM OF THE SIGN.
13. POSTS SHALL NOT EXTEND MORE THAN 4" ABOVE TOP OF SIGN.
14. TEMPORARY WOOD SUPPORTS DO NOT REQUIRE PRESERVATIVE TREATMENT.

NOT TO SCALE

MICHIGAN DEPARTMENT OF TRANSPORTATION BUREAU OF DEVELOPMENT STANDARD PLAN	F.H.W.A. APPROVAL	11/2/2017 PLAN DATE	WZD-100-A	SHEET 11 OF 11
--	-------------------	------------------------	-----------	-------------------

NOTE: THE ORIGINAL SIGNED COPY IS KEPT ON FILE AT THE MICHIGAN DEPARTMENT OF TRANSPORTATION.

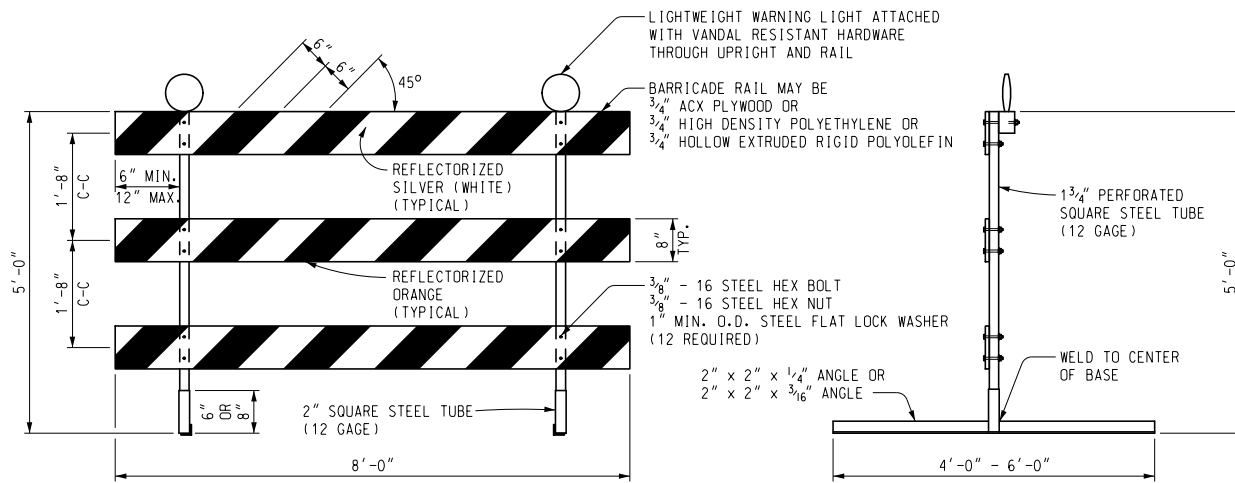

FRONT ELEVATION

SIDE VIEW

PERFORATED SQUARE STEEL TUBE OPTION

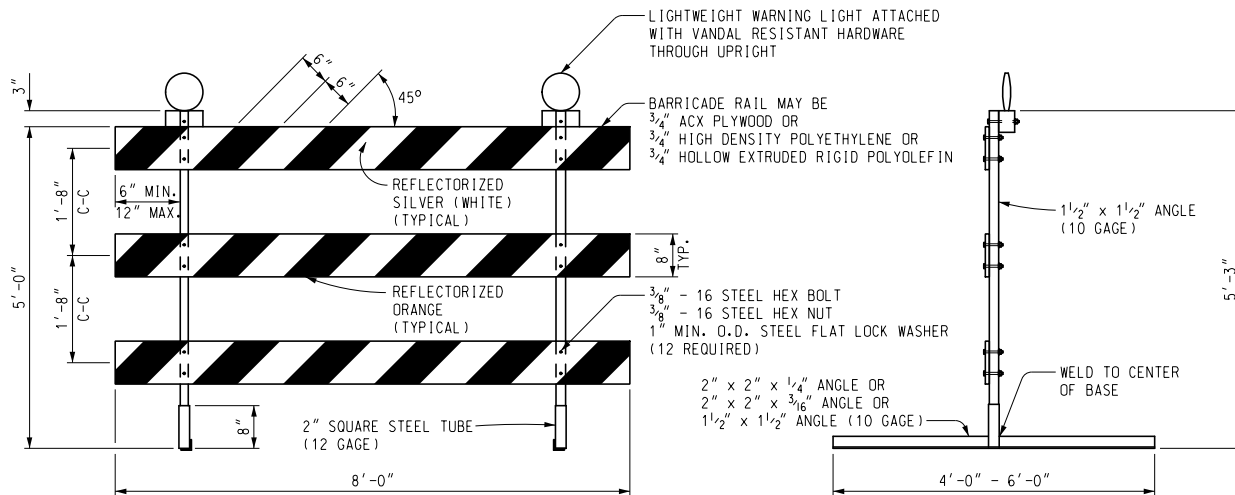

FRONT ELEVATION

SIDE VIEW

ANGLE IRON OPTION

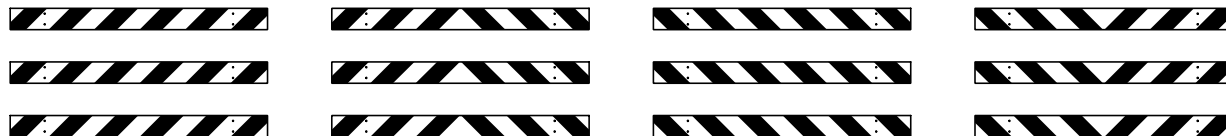

LEFT DIRECTIONAL

BI-DIRECTIONAL

RIGHT DIRECTIONAL

CLOSURES

**BARRICADE RAIL SHEETING OPTIONS
TYPE III BARRICADES**

Other Type III Barricades meeting current NCHRP crash worthy criteria can be found on the FHWA Safety website at http://safety.fhwa.dot.gov/roadway_dept/road_hardware/wzd.htm



PREPARED BY
DESIGN DIVISION

DRAWN BY: ECH

CHECKED BY: MWB

DEPARTMENT DIRECTOR
Kirk T. Steudle

APPROVED BY: _____
DIRECTOR, BUREAU OF FIELD SERVICES
ENGINEER OF DEVELOPMENT

APPROVED BY: _____
(SPECIAL DETAIL)
DIRECTOR, BUREAU OF DEVELOPMENT

MICHIGAN DEPARTMENT OF TRANSPORTATION
BUREAU OF DEVELOPMENT STANDARD PLAN FOR

**Temporary
Traffic Control Devices**

F.H.W.A. APPROVAL

1/18/11
PLAN DATE

WZD-125-E

SHEET
1 OF 3

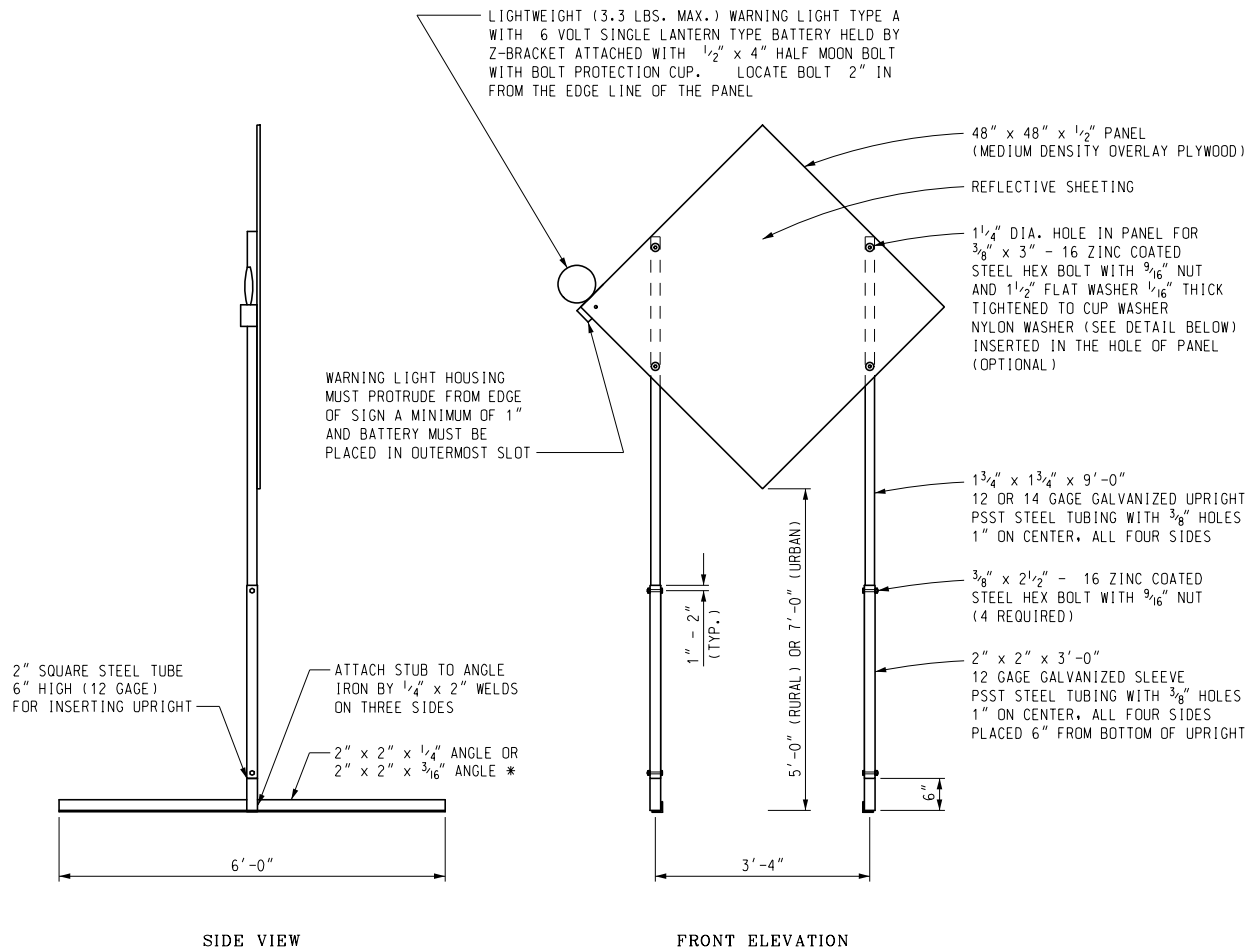

TEMPORARY SIGN SUPPORT
 (WARNING LIGHT PLACED ON SIDE CLOSEST TO TRAFFIC)
 * SIGN STAND IS BALLASTED WITH FOUR OR MORE 35 LB SANDBAGS. A MINIMUM OF ONE ON EACH END.
 UPRIGHTS SHALL NOT EXTEND ABOVE THE SIGN PANEL.

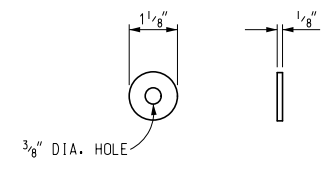
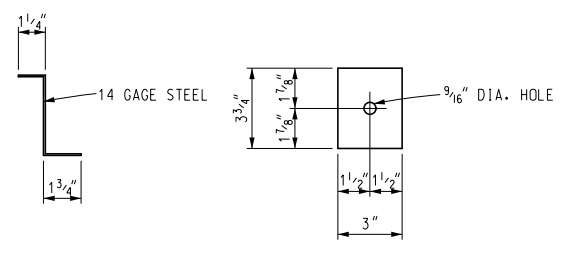

Other temporary sign supports meeting current NCHRP crash worthy criteria can be found on the FHWA Safety website at http://safety.fhwa.dot.gov/roadway_dept/road_hardware/wzd.htm

NOT TO SCALE

MICHIGAN DEPARTMENT OF TRANSPORTATION BUREAU OF DEVELOPMENT STANDARD PLAN	SPECIAL DETAIL F.H.W.A. APPROVAL	1/18/11 PLAN DATE	WZD-125-E	SHEET 2 OF 3
--	-------------------------------------	----------------------	-----------	-----------------

- PLASTIC DRUM
- ▲▲▲ PROPOSED TYPE III BARRICADE
- △△△ EXISTING TYPE III BARRICADE

SYMBOLS TO BE USED ON PLANS

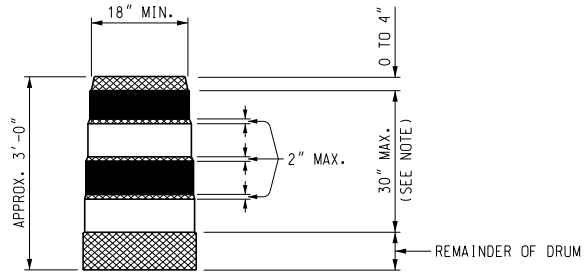

- REFLECTORIZED ORANGE
- REFLECTORIZED WHITE
- NON REFLECTORIZED ORANGE

NOTE:
 DRUMS SHALL HAVE AT LEAST 4 HORIZONTAL REFLECTORIZED STRIPES (2 ORANGE AND 2 WHITE) OF 6" UNIFORM WIDTH, ALTERNATING IN COLOR WITH THE TOPMOST REFLECTORIZED STRIPE BEING ORANGE. NON REFLECTORIZED SPACES BETWEEN THE HORIZONTAL REFLECTORIZED ORANGE AND WHITE STRIPES SHALL BE ORANGE IN COLOR AND EQUAL IN WIDTH.

PLASTIC DRUM

NOTES:

2" PERFORATED SQUARE STEEL TUBES MAY BE USED TO FABRICATE THE HORIZONTAL BASE OF THE TYPE III BARRICADE.

WARNING LIGHTS SHALL BE PLACED ACCORDING TO THE CURRENT STANDARD SPECIFICATIONS FOR CONSTRUCTION AND ALL OTHER PROVISIONS IN THE CONTRACT ON TYPE III BARRICADES.

SEE ROAD STANDARD PLANS R-113-SERIES FOR TEMPORARY CROSSOVERS FOR DIVIDED ROADWAY, AND R-126-SERIES FOR TYPICAL LOCATION AND SPACING OF PLASTIC DRUMS FOR PLACEMENT OF TEMPORARY CONCRETE BARRIER.

SIGNS, BARRICADES, AND PLASTIC DRUMS SHALL BE FACED WITH PRESSURE-SENSITIVE REFLECTIVE SHEETING ACCORDING TO THE CURRENT STANDARD SPECIFICATIONS FOR CONSTRUCTION.

SANDBAGS SHALL BE USED WHEN SUPPLEMENTAL WEIGHTS ARE REQUIRED TO ACHIEVE STABILITY OF THE BARRICADE. THE SANDBAGS SHALL BE PLACED SO THEY WILL NOT COVER OR OBSTRUCT ANY REFLECTIVE PORTION OF THE TRAFFIC CONTROL DEVICE.

NOT TO SCALE

MICHIGAN DEPARTMENT OF TRANSPORTATION
 BUREAU OF DEVELOPMENT STANDARD PLAN

(SPECIAL DETAIL)
 F.H.W.A. APPROVAL

1/18/11
 PLAN DATE

WZD-125-E

SHEET
 3 OF 3

CITY OF ANN ARBOR
DETAILED SPECIFICATION
FOR
MINOR TRAFFIC CONTROL

AA:DAD

1 of 4

03/11/19

a. Description. This work consists of protecting and maintaining vehicular and pedestrian traffic, in accordance with the sections 104.11 and 812 of the of the Michigan Department of Transportation (MDOT) 2012 Standard Specifications for Construction; Part 6 of the 2011 Edition of the Michigan Manual of Uniform Traffic Control Devices (MMUTCD); as directed by the Engineer, and as described herein.

The work includes, but is not limited to the following:

- The furnishing and operating of miscellaneous signs, warning devices, flags, and cones;
- The operation of additional signs furnished by the City;
- Furnishing and installing meter bags;
- Coordinating with Republic Parking System to have meter bags installed and removed;
- Maintaining pedestrian traffic;
- Temporarily covering/uncovering traffic controls as directed;
- Temporarily covering/uncovering existing signs as directed;
- Any/all other miscellaneous and/or incidental items that are necessary to perform the work properly.

b. Materials. Provide materials and equipment meeting the requirements specified in section 812 of the MDOT 2012 Standard Specifications for Construction.

c. Construction. Perform the work required by this detailed specification throughout the life of the Contract.

Maintain pedestrian traffic at all times. For maintaining normal pedestrian traffic while performing sidewalk and driveway repair place, Pedestrian Type II Baricade, Temp, Pedestrian Type II Channelizer, Temp, "Sidewalk Closed" and/or "Cross Here" signs at locations directed by the Engineer.

All temporary traffic/pedestrian control devices furnished by the Contractor will remain the property of the Contractor. The City is not responsible for stolen or damaged signs, barricades, barricade lights or other traffic maintenance items. Replace missing or damaged traffic control devices immediately. Preserve, protect, and maintain all existing signs, and signs erected by the City of Ann Arbor on this project. At the direction of the Engineer, City forces will repair or replace any existing City owned signs damaged by the Contractor during the work. Repair/replacement of other signs damaged by the Contractor will be its responsibility to perform in a timely manner.

Temporarily cover conflicting traffic and/or parking signs when directed by the Engineer.

The City will enforce parking violation citations issued to the Contractor, subcontractor, and material suppliers including each of their respective employees under appropriate City Code.

Where there is metered parking within the influence of project work, the Contractor will coordinate with Republic Parking System to have meter bags temporarily installed prior to commencing with any work, and removed when the work is complete.

Maintain vehicular and pedestrian traffic during the work by the use of traffic regulators, channelizing devices and signs as necessary, and as directed by the Engineer, and in accordance with 2011 Edition of the MMUTCD. This detailed specification includes typical applications for maintaining pedestrian traffic in accordance with the 2011 Edition of the MMUTCD.

In order to maintain areas of on street parking available for residents, the Engineer may direct the contractor to cover and uncover temporary "No Parking" signs within the project limits multiple times throughout the course of the project.

d. Measurement and Payment. Measure and pay for the completed work, as described, at the contract unit price using the following pay item:

<u>Pay Item</u>	<u>Pay Unit</u>
Minor Traffic Control, Max \$____	Lump Sum

Measure **Minor Traffic Control, Max \$____** by the unit lump sum and pay for it at the contract unit price, which price includes costs for all labor, equipment and materials necessary to complete the work. The contract unit price also includes payment for any/all costs related to any temporary traffic control devices directed for use by the Engineer where there is no specific pay item in the Contract, for repeated covering and uncovering of signs, and maintaining pedestrian traffic.

Include any/all costs for transporting temporary traffic control devices required by this detailed specification, or where there is no separate pay item in the contract, in the unit price for **Minor Traffic Control, Max \$____**.

The Contractor is solely responsible for any/all repair and/or replacement costs associated with damage to existing signs caused by its construction activities and/or operations.

Measurement will be on a pro rata basis at the time of each progress payment, and based on the ratio of work completed during the payment period and the total contract amount. When all of the work of this Contract is complete, the measurement of this item shall be 1.0 Lump Sum, less any deductions incurred for inadequate performance as described herein. This amount will not increase for any reason, including extensions of time, extras, and/or additional work.



Figure 6H-28. Sidewalk Detour or Diversion (TA-28)

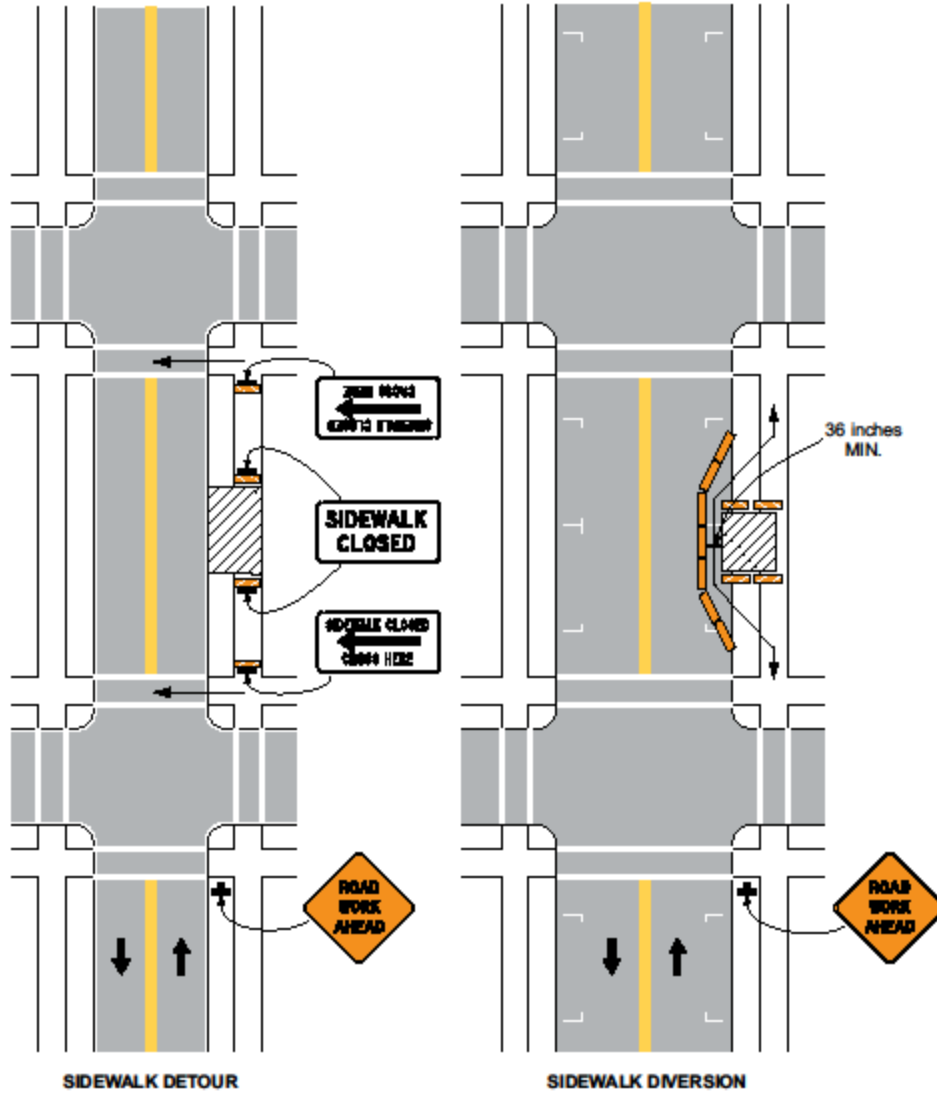

Typical Application 28

Note: See Tables 6H-2 and 6H-3 for the meaning of the symbols and/or letter codes used in this figure.

Figure 6H-29. Crosswalk Closures and Pedestrian Detours (TA-29)

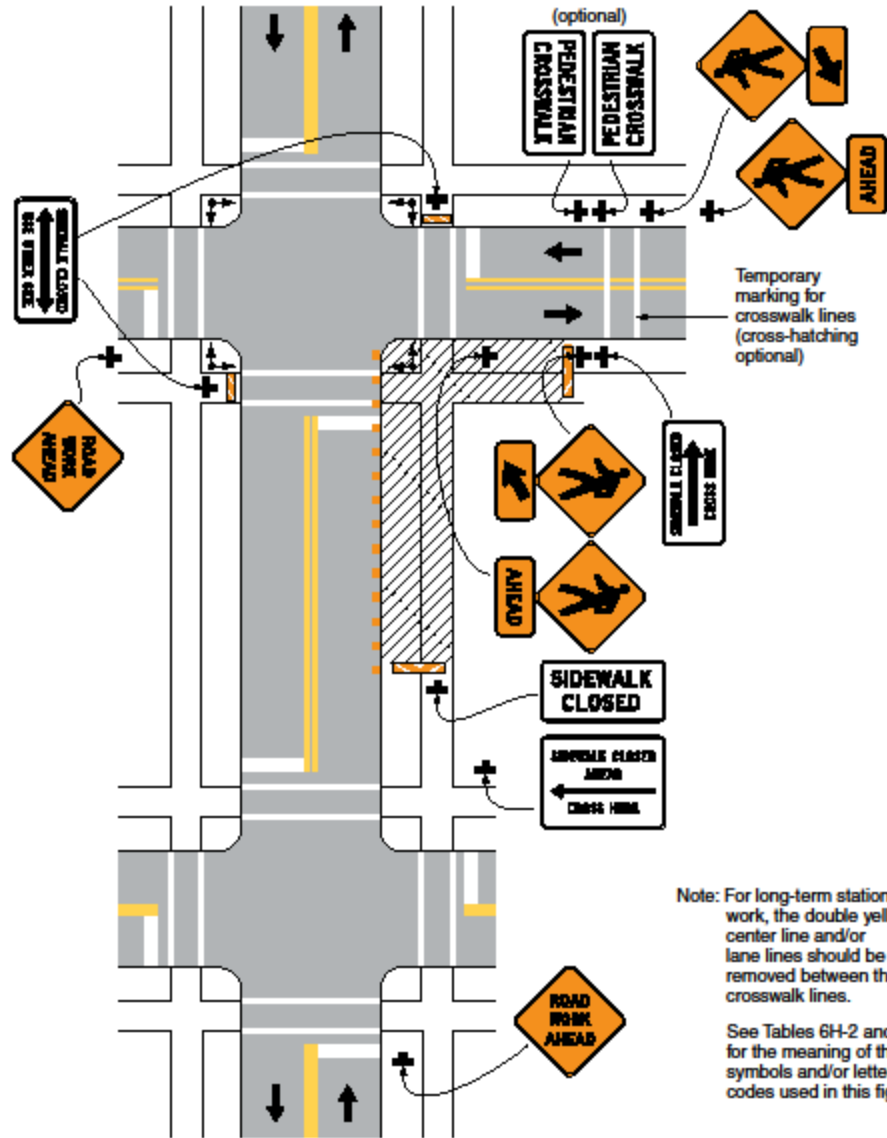

Typical Application 29

CITY OF ANN ARBOR
 DETAILED SPECIFICATION
 FOR
TEMPORARY NO PARKING SIGNS

AA:DAD

1 of 1

03/11/19

a. Description. This work consists of installing, maintaining and removing of "No Parking" signs and posts as outlined herein and as referenced on the plans. Install "No Parking" signs in accordance with the section 812 of the Michigan Department of Transportation (MDOT) 2012 Standard Specifications for Construction Standard Specifications and the 2011 Michigan Manual of Uniform Traffic Control Devices (MMUTCD).

b. Materials. The City will furnish "No Parking" signs to the Contractor at no cost. The Contractor will furnish the sign support and mounting hardware materials in accordance with those specified in section 919 of the MDOT 2012 Standard Specifications for Construction.

c. Construction. Place temporary "No Parking" signs prior to the commencement of any construction activity as directed by the Engineer. Obtain a permit for "Temporary Permission of Reserve Parking Lane for Work Related Purposes" from the City's Engineering Unit. Obtain this permit a minimum of five (5) business days prior to the posting of "No Parking" signs.

Securely bolt the signs to the sign supports as directed by the Engineer. Imbed all sign supports at least two feet into the ground, and ensure that installations are stable and safe. Provide a minimum six feet and maximum seven feet of clearance between the bottom of the installed sign and the ground. Place signs at intervals no greater than 75 feet, and as necessary to eliminate parking in the construction area.

Install temporary "No Parking" signs be in accordance with the permit, as as directed by the Engineer, and at least 48 hours prior to the proposed start-of-work/enforcement date. Cover temporary "No Parking" signs to allow for on-street parking until 48 to 24 hours prior to the start of the work. Cover temporary "No Parking" signs during non-working periods longer than 72 hours. Prior to beginning work and during construction, cover existing/permanent "No Parking" signs having messages that conflict with those that are temporary. Remove temporary "No Parking" signs and posts upon the completion of work at each location. Return signs to the City upon completion of all contract work, and/or when no longer needed.

d. Measurement and Payment. Measure and pay for the completed work, as described, at the contract unit price using the following pay item:

<u>Pay Item</u>	<u>Pay Unit</u>
Temporary No Parking Sign	Each

Measure **Temporary No Parking Sign** individually in place by the unit each and pay for it at the contract unit price, which price includes all cost for labor, equipment and materials necessary to complete the work. Measurement will be for the maximum number of signs installed on a project location at any one time. The unit price also includes the removal and return of "No Parking" signs to the City upon completion of the project, and the covering of any existing/permanent "No Parking" signs.

The City will back charge the Contractor for replacement costs associated with damaged and/or unreturned signs.

CITY OF ANN ARBOR
 DETAILED SPECIFICATION
 FOR
TEMPORARY PAVEMENT MARKINGS

AA:DAD

1 of 1

02/24/18

a. Description. This work consists of furnishing, installing, and disposing of temporary symbol special pavement markings in accordance with the contract and as directed by the Engineer. Where temporary special pavement markings are required in this contract, use Type R temporary wet reflective special markings if the markings applied during the project require removal during the life of the contract.

b. Materials.

Temporary Special Markings - Wet Reflective, Type R, Tape. Provide Type R temporary special markings from the Qualified Products List (subsection 922.06.A of the Standard Specifications for Construction). Apply and remove tape in accordance with the manufacturer's instructions. The tape must remain flexible and conform to the texture of the pavement surface during use. All curved arrows, curved legends, and curved symbols must be precut or fabricated prior to placement in the field.

c. Construction. Install the temporary pavement markings in accordance with the Michigan Department of Transportation (MDOT) Pavement Marking Standard Plan PAVE-900 Series.

Temporary Special Markings - Wet Reflective, Type R, Tape. Between April 15 and November 1, place Type R wet reflective tape in accordance with the manufacturer's specifications for existing temperature and pavement conditions.

Fabricate symbols prior to placement placed in the field.

Replace Type R wet reflective tape that fails, as directed by the Engineer. The Engineer will not pay for special markings that fail due to improper installation per the manufacturer's specifications. The Engineer will document the failure and meet with the Contractor and/or supplier to discuss reason for failure. Payment will be as determined by the Engineer. Unless documented in the Inspector's Daily Report (IDR) the Engineer will otherwise assume marking failure is a result of damage by traffic. The Engineer will pay for marking failure due to traffic or not clearly documented in an IDR at the contract unit price.

d. Measurement and Payment. Measure and pay for the completed work, as described, at the contract unit price using the following pay item:

<u>Pay Item</u>	<u>Pay Unit</u>
Pavt Mrkg, Wet Reflective, Type R, Tape, Rt Turn Arrow Sym	Each

Measure **Pavt Mrkg, Wet Reflective, Type R, Tape, Rt Turn Arrow Sym** individually in place by the unit each and pay for it at the contract unit price, which price includes the costs for all labor, equipment and materials necessary to provide, place, maintain (as noted), remove, and properly dispose of the temporary pavement marking.

CITY OF ANN ARBOR
 DETAILED SPECIFICATION
 FOR
PROTECTING AND PRESERVING IRRIGATION SYSTEMS

AA:DAD

1 of 1

03/11/19

a. Description. This work consists of protecting, preserving, and repairing, as required, existing irrigation systems that are likely located within the project limits and potentially affected by the project work. These underground sprinkler systems may irrigate both private property and portions of the public right-of-way, and utilize several different materials and/or suppliers for the various system components. Installations may be under or directly adjacent to paved areas, sidewalks, driveways, or curbs; may extend into landscaped islands or the lawn extension area; and may require relocation as part of the project construction. Work involves investigating and locating any systems, protecting them from damage, and ensuring their continued and proper operation during the performance of project work. It also includes re-establishing operations as necessary, and upon completion of all project work, to ensure that all existing sprinkler systems encountered are functioning in a satisfactory manner as determined by the Engineer.

b. Materials. None specified.

c. Construction. Perform all necessary investigations to determine the precise location of the irrigation systems, and all affected components, prior to the commencement of construction operations. Determine all impacts to the systems that could result from the project work, and take the necessary actions to ensure that the systems will remain functional and/or re-established them in such a manner at appropriate intermediate and final project milestones so they operate the same or better condition than prior to construction activities.

Contact all property owners prior to the commencement of the work in order to determine the impacts to their irrigation systems and coordinate project work with them to ensure satisfactory operation of their irrigation systems during construction.

The Engineer and affected property owner will approve any/all necessary repair work to an irrigation system, and the Contractor will complete such work as directed by the Engineer and prior to the conclusion of work at the project location.

d. Measurement and Payment. Measure and pay for the completed work, as described, at the contract unit price using the following pay item:

<u>Contract Item (Pay Item)</u>	<u>Pay Unit</u>
Irrigation System, Protection and Maintenance.....	Dollar

Measure **Irrigation System, Protection and Maintenance** by the unit dollar and pay for it at the contract unit price, which price includes all cost for labor, equipment and materials necessary to complete the work.

CITY OF ANN ARBOR
 DETAILED SPECIFICATION
 FOR
SLOPE RESTORATION

AA:DAD

1 of 3

03/11/19

a. Description. This work consists of preparing all manicured lawns and slopes on non-freeway projects designated for slope restoration on the plans or by the Engineer, and applying topsoil, fertilizer, seed, and mulch blankets to those areas. Turf establishment shall be in accordance with section 816 of the Michigan Department of Transportation (MDOT) 2012 Standard Specifications for Construction and Standard Plan Series R-100, except as modified herein or otherwise directed by the Engineer.

b. Materials. The materials and application rates shall meet the requirements specified in subsection 816.02 and section 917 of the MDOT 2012 Standard Specifications for Construction and as specified herein unless otherwise directed by the Engineer.

1. Topsoil Surface: Place 4 inches of topsoil in area disturbed areas designated for restoration. Topsoil shall be free of all stones one inch in diameter or greater.
2. Turf Seed Mixture: Use seed mixture shown in table below. Seed shall be fresh, clean, dry, new-crop seed complying with the AOSA's "Rules for Testing Seed", tested for purity and germination tolerances.

Species/Variety	Mix Proportions (percent by weight)	Purity (percent)	Germination (percent)
Baron Kentucky Bluegrass	25	90	80
Kentucky Bluegrass 98/80	15	98	80
Park Kentucky Bluegrass	15	90	80
Omega III Perennial Ryegrass	20	98	90
Creeping Red Fescue	25	95	90

Maximum weed content shall be 0.30%.

3. Chemical Fertilizer Nutrient: Use Class A fertilizer.
4. 4. Mulch Blanket: Use excelsior mulch blanket free of chemical additives. The netting thread and anchoring devices must be 100 percent biodegradable. **Use no polypropylene or other non-biodegradable netting.** Provide wood or other biodegradable anchors, at least 6 inches in length, as approved by the Engineer. **Do not use steel wire staples or pins to anchor mulch blankets.**

c. Construction. Construction methods shall be in accordance to subsections 816.03 and 817.03 of the MDOT 2012 Standard Specifications for Construction. Begin this work as soon as possible after final grading of the areas designated for slope restoration but no later than the maximum time limitations stated in subsection 208.03 of the Standard Specifications for Construction. It may be necessary, as directed by the Engineer, to place materials by hand.

Restore all areas as shown on the plans and others disturbed by the Contractor's activity(s) and as identified by the Engineer. Slope restoration includes furnishing and placing topsoil, applying seed and fertilizer, placing mulch blankets, and watering as necessary for the establishment of turf.

Prior to placing topsoil, grade, shape, compact and assure all areas to be seeded are weed free. Place topsoil to the minimum depth required, to meet proposed finished grade. Spread and rake topsoil to provide a uniform surface free of large clumps, rocks, brush, roots, or other

deleterious materials, as determined by the Engineer. Remove any stones greater than or equal to 1 inch in diameter. If the area designated for restoration requires more than the minimum depth of topsoil to meet finished grade, the additional depth must be filled using topsoil. Furnishing and placing this additional material is included in this item of work.

Place topsoil that is weed and weed seed free and friable prior to placing seed. Apply seed mixture and fertilizer to prepared soil surface. Incorporate seed into top 1/2 inch of topsoil.

Use mulch blanket on all areas designated for restoration unless otherwise directed by the Engineer. Install mulch blanket per the manufacturer's published instructions.

Protect and maintain restored areas to establish a uniform, dense, vigorous, and weed free turf without mounds and/or depressions. Begin maintenance immediately upon completion of restoration work and continue up to final acceptance. This includes, but is not limited to, watering to promote seed germination and prevent seed and seedlings from drying out; deposition of additional topsoil, re-seeding, fertilizing, and placement of mulch blankets to address areas damaged by washouts and soil erosion, non-uniform germination and bare spots. It also includes any other work required to correct all settlement, erosion, germination, and establishment issues.

If areas washout and/or erode after completing the work and obtaining approval by the Engineer, make the required corrections to prevent future washouts and erosion and replace the topsoil, fertilizer, seed and mulch as required and directed by the Engineer.

Scattered bare spots in seeded areas will not be allowed over three (3) percent of the area nor greater than 6"x 6" in size.

Water seeded areas, at 3 1/2 gallons per square yard, as directed by the Engineer; and continue watering regularly throughout the maintenance period as required and directed by the Engineer.

If the Engineer determines weeds cover more than ten percent of the total area of slope restoration, the Contractor will provide weed control in accordance to subsection 816.03.J of the MDOT 2012 Standard Specifications for Construction.

Prior to acceptance, the Engineer will inspect the restored areas to ensure the turf is well established, weed free, in a vigorous growing condition, and contains the species called for in the seeding mixture. If areas do not promote growth, the Contractor will apply new seed, fertilizer and mulch blankets, and water as required.

Upon fulfillment of the above requirements, the Engineer will accept the slope restoration.

Unless otherwise approved by the Engineer, final acceptance will occur no sooner than October 10 of the same year for areas initially restored during the spring (April 15 - June 15) planting season; or, no sooner than June 15 of the following year for areas initially restored during the prior summer/fall (after June 15) planting season.

d. Measurement and Payment. Measure and pay for the completed work, as described, at the contract unit price using the following pay item:

<u>Pay Item</u>	<u>Pay Unit</u>
Slope Restoration.....	Square Yard

Measure **Slope Restoration** area in place by the unit square yard and pay for it at the contract unit price, which price includes the costs for all labor, equipment and materials necessary to complete the work.

The Contractor will restore areas disturbed by its operations and not required by the Project at its own expense.

The Engineer will not pay for any labor, equipment and material costs for the Contractor to perform watering as required to establish and/or maintain turf.

The Engineer will not pay for any labor, equipment and material costs for the Contractor to provide weed control.

The Contractor will repair and/or clean any damage or soiling to signs, fences, trees, pavements, structures, etc. at its own expense.

After initial placement of the slope restoration measures, the Engineer will certify for payment fifty (50) percent of the total quantity placed for each item. The Engineer will certify for payment the remaining fifty (50) percent of the total quantities upon full establishment and final acceptance of any restored area.

CITY OF ANN ARBOR
DETAILED SPECIFICATION
FOR
ELECTRICAL AND COMMUNICATION HANDHOLES

AA:DAD

1 of 2

03/11/19

a. Description. This work consists of furnishing and installing traffic signal handholes and communication handhole assemblies at the locations shown in the Plans, or as directed by the Engineer. Complete all work in accordance with the current National Electric Code (NEC), section 819 of the Michigan Department of Transportation (MDOT) 2012 Standard Specifications for Construction, except as specified herein.

b. Materials. Provide materials that are new and meet the requirements of the current IEEE, NEMA, ANSI Standards as applicable, and as specified herein.

Submit product data sheets for all handholes, covers and other parts for Engineer approval prior to ordering materials. The location of manufacturer "Quazite Composolite," referenced below, is in Lenoir City, Tennessee.

Provide 12 inch x 18 inch handhole assemblies consisting of a "Quazite Composolite" #PG1118BA12 box and a #PG1118HA41 locking heavy-duty bolt-down type cover with a logo that reads "Street Lighting", or an Engineer approved equivalent. The total depth of the handhole is 12 inches.

Provide 17 inch x 30 inch handhole assemblies consisting of two "Quazite Composolite" boxes with the lower one being a #PG1730BB18 box and the upper one being a #PG1730BA18 and the cover being a #PG1730HA46 locking heavy-duty bolt-down type with a logo that reads "Traffic Signal", or an Engineer approved equivalent. The total depth of the handhole is 36 inches.

Provide 24 inch x 36 inch handhole assemblies consisting of a "Quazite Composolite" #PG2436BA24 box and a # PG2436HA12 locking heavy-duty bolt-down type cover with a logo that reads "Street Lighting", or an Engineer approved equivalent. The total depth of the handhole is 24 inches.

Provide Class II granular material in accordance with section 902 of the MDOT 2012 Standard Specifications for Construction.

c. Construction. Place handholes at all junctions of traffic signal or electrical conduit, and as shown on the plans. Maximum distance between any two handholes is as shown on the Plans, and is not to exceed 500 feet.

Place foundation material consisting of four (4) inches of Granular Material, CI II compacted to 95% of its maximum unit weight.

Set the handhole or stacked units to the proper depth and elevation.

Connect handholes to new and existing conduits, whether shown on the plans or not. Connect all conduits to the handholes in accordance with the latest revision of Article 346 of the National Electrical Code (NEC).

Backfill around the perimeter of the handhole with Granular Material, CI II compacted to 95% of its

maximum unit weight.

d. Measurement and Payment. Measure and pay for the completed work, as described, at the contract unit price using the following pay items:

<u>Pay Item</u>	<u>Pay Unit</u>
Handhole Assembly, 12 inch x 18 inch	Each
Handhole Assembly, 17 inch x 30 inch	Each
Handhole Assembly, 24 inch x 36 inch	Each

Measure **Handhole Assembly, ___ inch x ___ inch** individually in place by the unit each and pay for them at their respective contract unit prices, which prices include the costs for all labor, equipment and materials necessary to complete the work. Payment also includes the excavation and disposal of materials, furnishing, installing and compacting Granular Material, CI II, and all work related to connecting handholes to new and existing conduits, whether or not shown on the plans.

APPENDIX

- Notice(s) to Bidders
- Michigan Department of Transportation (MDOT)
Special Provisions
 - MDOT Supplemental Specifications
 - MDOT Standard Plans/Special Details
- City of Ann Arbor Standard Plans/Special Details
 - Geotechnical Information
- General Decision Number: MI20210001 01/01/2021

CITY OF ANN ARBOR

NOTICE TO BIDDERS

PROJECT COORDINATION

AA:DAD

1 of 1

02/20/21

The City of Ann Arbor hereby notifies the Contractor of several independent construction projects within the local vicinity of, or directly adjacent to, the Construction Influence Area (CIA) of the project locations listed below. These projects may affect various work activities, maintenance of traffic (MOT), and/or trucking operations involved with these locations. The City anticipates construction of these independent project during the same timeframe as this project.

- Towner Boulevard CIA & MOT: Coordinate with Ann Arbor Public Schools Allen Elementary School site work.

The above is not necessarily a complete listing of all area projects that could potentially impact this one. Prior to commencing with any construction, the Contractor shall verify with the City the presence of any other concurrent public or permitted projects within the vicinity.

The Contractor shall coordinate its work on this project with that by Contractor(s) on all other projects within the local vicinity, as directed by the Engineer. The Engineer will make no additional compensation or adjustments to contract unit prices for costs incurred by the Contractor due to coordinating with or delays caused by other projects.

CITY OF ANN ARBOR

NOTICE TO BIDDERS

UTILITY COORDINATION

AA:DAD

1 of 1

03/05/19

The contractor shall cooperate and coordinate construction activities with the owners of utilities as stated in Section 104.08 of the 2012 Michigan Department of Transportation (MDOT) Standard Specifications for Construction. In addition, for the protection of underground utilities, the contractor shall follow the requirements in Section 107.12 of the 2012 MDOT Standard Specifications for Construction. Contractor delay claims, resulting from a utility, will be determined based upon Section 109.05.E of the 2012 MDOT Standard Specifications for Construction.

For protection of underground utilities and in conformance with Public Act 174 of 2013, the contractor shall dial 800-482-7171 or 811 a minimum of three (3) full working days, excluding Saturdays, Sundays, and holidays prior to beginning construction in areas where utilities have not been previously located. The "Miss Dig" alert system will then routinely notify members to locate and mark their facilities. This, however, does not relieve the contractor of the responsibility of notifying utility owners that may not be a part of the system.

There will be no requirement for owners of public or private utilities to move their facilities on or from within the street right-of-way if those facilities will not interfere with the proposed project work and they do not present a hazard to the public or an extraordinary hazard to the Contractor's operations.

The City will not require utilities owners to move additional poles or structures in order to facilitate the operation of construction equipment unless the Engineer determines that such poles or structures constitute a hazard to the public or are dangerous to the Contractor's operations.

Private utility owners will complete any/all necessary relocations prior to construction.

The following is a list of Private and Public Utilities that may or may not have facilities located within the Right-of-Way. This list is for informational purposes only and is not an exhaustive list of utilities located within the Right-of-Way.

ATT – Telecommunications/Fiber Optic
550 South Maple Road
Ann Arbor, MI 48103
Contact: Jeff Lehman 734-996-5334

City of Ann Arbor – Water, Storm, Sanitary,
Telecommunications/Fiber Optic
W.R. Wheeler Service Center
4251 Stone School Road
Ann Arbor, MI 48108 734 794-6351

Comcast – Telecommunications/Fiber Optic
27800 Franklin Road
Southfield, MI 48034
Contact: Ron Sutherland 313-999-8300

DTE Energy – Electric & Street Lighting
8001 Haggerty Road
Belleville, MI 48111
Contact (Electric): Anthony Ignasiak 734-397-44447
Contact (Lighting): Lance Alley 734-397-4188

DTE Energy – Gas
3150 E. Michigan Ave
Ypsilanti Township, MI 48198
Contact: Robert Czapiewski 734-544-7818

MCI – Telecommunications/Fiber Optic
2800 North Glenfille Road
Richardson, TX 75082
Contact: Dean Boyers 972-729-6016

MICHIGAN
DEPARTMENT OF TRANSPORTATION

SPECIAL PROVISION
FOR
PROGRESS SCHEDULE

CFS:JJG

1 of 1

APPR:MB:LFS:01-09-18
FHWA:APPR:03-01-18

Delete the definition for Progress Schedule in subsection 101.03, on page 12 of the Standard Specifications for Construction, in its entirety and replace with the following:

Progress Schedule. A sequential listing of all the controlling operations and the estimated time the operations will remain controlling. The progress schedule is submitted by the Contractor after award and prior to starting work and is reviewed and approved by the Department. When approved, the progress schedule, or updated progress schedule, will become part of the contract.

Delete subsection 102.14, on page 22 of the Standard Specifications for Construction, in its entirety.

Delete the first sentence in the second paragraph of subsection 108.05, on page 74 of the Standard Specifications for Construction, in its entirety and replace with the following.

Submit a critical path method (CPM) schedule if required in the contract documents. Submittal of a progress schedule will not be required as the CPM schedule will replace the progress schedule.

Add the following paragraphs directly below the first paragraph of subsection 108.05.A.1, on page 74 of the Standard Specifications for Construction.

The progress schedule is to be submitted by the Contractor to the Engineer within 7 calendar days of award and prior to starting work.

The Engineer will provide documented approval, comments, or rejection within 7 calendar days of receipt of the Contractor's submittal, resubmittal, or responses.

The Contractor must resolve all responses within 7 calendar days of receipt of any Engineer requests or rejections.

If the progress schedule is not approved within 30 calendar days of contract award, the Engineer may withhold all or part of contract payments until the progress schedule is approved.

Delete the last sentence in the first paragraph of subsection 108.05.A.2, on page 74 of the Standard Specifications for Construction in its entirety.

MICHIGAN
DEPARTMENT OF TRANSPORTATION

SPECIAL PROVISION
FOR
DEBRIS OR MATERIALS IN TRAFFIC LANES

CFS:BRZ

1 of 1

APPR:EMB:DAJ:01-10-08
FHWA:APPR:06-01-11

Delete Subsection 104.07.B.2 on page 36 of the Standard Specifications for Construction, in its entirety and replace it with the following:

2. **Construction Safety Program.** Before beginning work on the project, the Contractor must submit a written "Construction Safety Program" that outlines the plan and procedures for preventing and mitigating accidents and fires on the project and meeting all health and safety requirements of the contract. Also in the program include provisions for meeting the requirements of subsection 812.03 and details for the materials and equipment that will be used to prevent construction related debris or materials from entering the open lanes of traffic and what actions, including traffic control measures, will be taken to immediately and safely remove the debris or material from the roadway. The Contractor must meet with the Engineer to discuss the "Construction Safety Program" and to develop mutual understandings to govern the administration and enforcement of the program.

Replace the second sentence in the first paragraph of Subsection 104.07.C.3 on page 37 of the Standard Specifications for Construction with the following:

The Contractor is responsible, at the Contractor's expense, to provide the necessary materials and equipment to prevent construction related debris or materials from entering the open lanes of traffic. This includes protection of traffic controls, removal of spilled materials or debris from the roadbed or drainage courses, and repair of damaged facilities necessary for public travel and safety.

MICHIGAN
DEPARTMENT OF TRANSPORTATION

SPECIAL PROVISION
FOR
HIGH VISIBILITY CLOTHING

SSA:JDG

1 of 1

APPR:MWB:CRB:05-25-18
FHWA:APPR:06-01-18

Add the following, to the end, of subsection 104.07.B, Safety and Health Requirements, on page 36 of the Standard Specification for Construction:

4. **Worker Visibility.** All workers must wear high-visibility safety apparel as specified in the MMUTCD.

Costs incurred to comply with this requirement will be the responsibility of the Contractor.

Revise the second paragraph of subsection 812.03.G.8, on page 619 of the Standard Specification for Construction to read:

Equip traffic regulators with the following:

- a. High-visibility safety apparel as specified in the MMUTCD;
- b. "Stop/Slow" or "Stop/Stop" sign paddles; and
- c. A two-way radio system and a standby back-up system, if traffic regulators are not visible to each other.

Delete the subsection 922.11.B, on page 944 of the Standard Specification for Construction in its entirety and replace with the following:

- B. **Traffic Regulator's High-Visibility Safety Apparel.** Traffic regulators must wear high-visibility safety apparel as specified in the MMUTCD.

MICHIGAN
DEPARTMENT OF TRANSPORTATION

SPECIAL PROVISION
FOR
TEMPORARY TRAFFIC CONTROL MATERIALS

OFS:RAL

1 of 1

APPR:CRB:JFS:11-21-16
FHWA:APPR:11-22-16

Add the following subsection to subsection 105.01.B, on page 48 of the Standard Specifications for Construction:

1. Temporary traffic control materials that are covered in the Materials Quality Assurance Procedures Manual, section 4.10 *Temporary Traffic Control Certification and Acceptance Procedure*, are not required to be listed in the *Materials Source List*.

MICHIGAN
DEPARTMENT OF TRANSPORTATION

SPECIAL PROVISION
FOR
CONSTRUCTION STAGING AREAS

DES:LFS

1 of 1

APPR:JJG:KAS:10-06-11
FHWA:APPR:10-11-11

Add the following subsection to section 107, on page 70 of the 2012 Standard Specifications for Construction:

107.22 Construction Staging Areas. The contractor must not use any public recreation area as a staging area, marshalling yard, storage facility, or for any other construction support unless it is defined in the contract.

Public recreation areas include: parks, trails, game areas, wildlife and waterfowl refuges, playgrounds, golf courses, athletic fields or similar areas which are publically owned by public school districts, local, state, or federal governments.

Any agreements negotiated between the Contractor and the owner of the public recreation area, before or after the award of the contract will not be considered valid by the Department.

If the Engineer determines the Contractor is in non-compliance with this subsection, penalties up to and including termination of the contract, in accordance with subsection 108.12, may be enacted as well as the immediate restoration of the public recreation area at the Contractor's cost.

MICHIGAN
DEPARTMENT OF TRANSPORTATION

SPECIAL PROVISION
FOR
OPEN TO TRAFFIC

CFS:JJG

1 of 1

APPR:MB:DBP:07-07-17
FHWA:APPR:07-10-17

Delete subsection 107.21, on page 69 of the Standard Specifications for Construction, in its entirety and replace with the following:

107.21. Open to Traffic. The Contractor must not open the project or sections thereof to traffic until approved by the Engineer. Whenever the project or section thereof is in a condition suitable for traffic, the Engineer will determine if it is approved for traffic before project completion and the Contractor must open the project or section thereof to traffic as directed by the Engineer. To determine whether the project or section thereof is approved for traffic, the Engineer will verify that the surfacing material, shoulders, guardrails, signs, and other appurtenances are completed as required by the contract. The Engineer's approval of the project or section thereof for traffic does not constitute partial or final acceptance of the project or any part of it, or a waiver of any provision of the contract. The Contractor is not responsible for the costs of maintaining the section of the project opened for traffic.

If the Engineer approves the entire project or any section of it for traffic and the Contractor opens it to traffic before final acceptance and final payment, the Contractor must perform the remainder of the work in a manner that causes the least obstruction to traffic. The Contractor must make provisions for the safety of traffic as required by the contract. Legal weight restrictions, established by 1949 PA 300 as amended, local ordinances, or legal posting, apply to sections of the project opened to traffic.

Before the seasonal suspension, the Engineer will determine the work the Contractor must complete to bring the project to an acceptable condition for traffic and winter maintenance, including necessary traffic and erosion control measures. Until the Contractor completes this work, the Engineer will not designate the project as approved for traffic. On sections of the project opened to traffic, the Contractor must correct damage due to defective materials, to faulty workmanship, to operations of the Contractor, and to natural causes (except as provided in subsection 107.11 of the Standard Specifications for Construction), at no additional cost to the Department.

MICHIGAN
DEPARTMENT OF TRANSPORTATION

SPECIAL PROVISION
FOR
SCHEDULE OF LIQUIDATED DAMAGES FOR OVERSIGHT

CFS:BED

1 of 1

APPR:MB:JJG: 07-15-16

FHWA:APPR:07-29-16

Delete Table 108-1 in subsection 108.10.C.1, on page 83 of the Standard Specifications for Construction, in its entirety and replace with the following.

Table 108-1		
Schedule of Liquidated Damages for Oversight		
Original Contract Amount		Amount per Calendar Day, \$
From more than, \$	To and including, \$	
0	100,000	400
100,000	500,000	700
500,000	1,000,000	950
1,000,000	5,000,000	1,350
5,000,000	15,000,000	2,300
Over 15,000,000		3,900

MICHIGAN
DEPARTMENT OF TRANSPORTATION

SPECIAL PROVISION
FOR
FORCE ACCOUNT BUSINESS TAXES

CFS:RJC

1 of 1

APPR:JJG:JDM:04-14-15
FHWA:APPR:04-17-15

Delete subsection 109.05.D.8, on page 101 of the 2012 Standard Specifications for Construction in its entirety.

MICHIGAN
DEPARTMENT OF TRANSPORTATION

SPECIAL PROVISION
FOR
**FORCE ACCOUNT MARK-UP FOR BOND PREMIUM, INSURANCE AND PAYROLL
TAXES**

CFS:JJG

1 of 1

APPR:LFS:MB:08-12-16

FHWA:APPR:08-18-16

Delete subsection 109.05.D.4, on page 97 of the Standard Specifications for Construction, in its entirety.

Delete the first paragraph of subsection 109.05.D.3, on page 96 of the Standard Specifications for Construction, in its entirety and replace with the following:

3. **Labor.** The Engineer will pay the Contractor an amount equal to the sum of the following labor costs, plus 55 percent of the sum (for road work) or 60 percent of the sum (for bridge work) to cover the costs of field and home office overhead, bond premium, insurance, payroll taxes and to provide for a reasonable profit.

MICHIGAN
DEPARTMENT OF TRANSPORTATION

SPECIAL PROVISION
FOR
DELAY COSTS

CFS:JJG

1 of 1

APPR:RJC:MB:02-22-17
FHWA:APPR:02-27-17

Delete subsections 109.05.E.1.a through 109.05.E.1.e, on page 102 of the Standard Specifications for Construction, in their entirety and replace with the following:

- a. Proof of cost of project staff salaries, wages, payroll taxes and insurance.
- b. Proof of escalated cost for labor, equipment, and material.
- c. Proof of material storage costs.

MICHIGAN
DEPARTMENT OF TRANSPORTATION

SPECIAL PROVISION
FOR
VERTICAL EXPLORATORY INVESTIGATION

SIG:EMS

1 of 2

APPR:DMG:NL:06-27-17
FHWA:APPR:07-11-17

a. Description. The use of this special provision is to compensate the Contractor to locate underground infrastructure, such as culverts, sewers and utilities, and must only be used as directed and approved by the Engineer. This special provision is not to compensate the Contractor for the responsibilities in subsection 107.12 of the Standard Specifications for Construction.

This work consists of conducting a vertical exploratory investigation to expose an existing culvert, sewer or utility in order to verify the location, condition, size, material and/or alignment; allowing the Engineer to document the necessary information; and backfilling the excavation. This work includes providing necessary lane, shoulder and/or sidewalk closures required to perform work.

b. Materials. Use Granular Material Class III in accordance with section 902 of the Standard Specifications for Construction for backfill. Use material removed during exploratory investigation for backfill only if approved by of the Engineer.

c. Construction. The owner of any sewer or utility to be exposed will not take the facilities out of service during the exploratory investigation. Contact utility owners in accordance with subsection 107.12 of the Standard Specifications for Construction.

Establish necessary lane, shoulder and/or sidewalk closures required to perform work.

Advance the exploratory excavation using vacuum excavation, hand digging, conventional machine excavation, or a combination thereof subject to approval of the Engineer. Allow the Engineer access to document the necessary information. If the technique used to advance the excavation causes any damage to the existing facilities, immediately contact the utility owner and cease all work until an alternate method is approved by the Engineer.

Take care to protect the exposed culvert, sewer or utility from damage during construction. Repair or replace culvert, sewer or utility, damaged during exploratory excavation, in accordance with the standard specifications and as approved by the Engineer.

Obtain the Engineer's approval before backfilling the excavation. Complete backfilling no later than 24 hours after approval has been given. Backfill in accordance with subsection 204.03.C of the Standard Specifications for Construction. Dispose of excess material in accordance with the standard specifications.

The Contractor is responsible for all costs associated with the repair work and out of service time of all broken or damaged existing culverts, sewers or utilities as a result of any action by the Contractor. If the exploratory investigation results in damage to utilities, contact the owner of such utility to coordinate the repair.

d. Measurement and Payment. The completed work, as described, will be measured and paid for at the contract unit price using the following pay item:

Pay Item	Pay Unit
Exploratory Investigation, Vertical.....	Foot

Exploratory Investigation, Vertical will be measured by the foot from top of existing grade vertically to the bottom of the excavation for a 4-foot maximum diameter hole, or as approved by the Engineer. The excavated depth of each 4-foot maximum diameter hole will be measured separately for payment.

Exploratory Investigation, Vertical includes all labor, equipment and materials required to complete the work, including all costs associated with repair or replacement resulting from the Contractor's activities.

MICHIGAN
DEPARTMENT OF TRANSPORTATION

SPECIAL PROVISION
FOR
**NON-COMPLIANCE WITH SOIL EROSION AND SEDIMENTATION CONTROL
REQUIREMENTS**

CFS:DMG

1 of 2

APPR:TWK:HZ:06-13-17

FHWA:APPR:06-13-17

a. Description. This special provision establishes negative adjustments related to the failure to properly install and maintain soil erosion and sedimentation control (SESC) measures and the conditions under which these adjustments will be determined and applied. Nothing in this special provision modifies section 107 of the Standard Specifications for Construction.

Delays to the project as a result of the Contractor conducting corrective actions for SESC measures do not constitute a valid reason for an extension of time.

Ensure deficiencies with SESC measures are corrected in the time frame stated herein. For those deficiencies not corrected within the stated time frame, the Engineer will make a negative adjustment to the contract as stated herein.

b. Materials. None specified.

c. Construction. Install all temporary erosion control measures identified on the plans and as directed by the Engineer for an impacted area of the project prior to the start of any earth disturbance including, but not limited to, clearing, grading and excavation in that area. The Engineer will inspect these measures every 7 days and within 24 hours after a precipitation event that results in a discharge from the site. Deficiencies will be documented on the National Pollutant Discharge Elimination System and SESC Inspection Report (MDOT Form 1126).

If at any time during the project, including the time during the seasonal suspension, the Engineer documents deficient SESC measures, the Engineer will provide written notification with instructions for corrective action to the Contractor. The time frame for completion of these corrective actions will be specified in the notification and will be discussed with the Contractor as necessary.

Deficiencies are defined as one or more of the following:

1. Failure to install or construct SESC measures shown on the plans or as directed by the Engineer;
2. Failure to maintain the measures;
3. Failure to conduct earth change activities in a manner consistent with all applicable environmental permit requirements;
4. Failure to comply with the area limitations or the time limitations stated in subsections 208.03.A and 208.03.B, respectively, of the Standard Specifications for Construction.

SESC deficiencies are either emergency or non-emergency and the time frame for corrective action is determined accordingly. Sediment leaving the right-of-way or entering a drainage structure, waters of the state, or loss of support of the roadbed impacting public safety constitutes an emergency and corrective actions must be completed within 24 hours of notification, including weekends or holidays regardless of whether the Contractor is working or not. Non-emergency deficiencies must be corrected within 5 calendar days of notification.

For those emergency corrective actions not completed within 24 hours of notification, the Contractor will be assessed \$100.00 per hour for every hour the deficiency remains uncorrected after the initial 24 hours of notification. For those non-emergency corrective actions not completed within 5 calendar days, the Contractor will be assessed \$500.00 per day for every day, or part thereof, the deficiency remains uncorrected after the initial 5 days of notification.

If it is not practicable to complete the non-emergency corrective actions within 5 calendar days, the Contractor must document the reasons and propose a corrective action plan to the Engineer within 5 days of notification. The corrective action plan must contain the Contractor's course of action and a time frame for completion. If the reasons and the corrective action plan are acceptable to the Engineer, the Contractor will be allowed to proceed with the plan as proposed without incurring a negative adjustment. If the approved corrective action plan is not completed as proposed, the Contractor will be assessed \$1000.00 per calendar day for every day, or part thereof, the deficiency remains uncorrected after the time frame is exceeded in the approved corrective action plan.

Correct, in the timeframe stated herein, all other emergency or non-emergency SESC deficiencies documented anywhere else on the project during completion of the approved corrective action plan.

d. Measurement and Payment. The Engineer will make the necessary monetary adjustment to the contract amount based on the length of time the Contractor allows the deficiencies to remain uncorrected after the time allowance stated herein and as described to cover any costs incurred by the Department as a result of SESC violations.

All costs associated with corrective actions required due to the Contractor's failure to properly install or maintain SESC measures on this project will be borne by the Contractor.

MICHIGAN
DEPARTMENT OF TRANSPORTATION

SPECIAL PROVISION
FOR
EROSION CONTROL, INLET PROTECTION, FABRIC DROP

CFS:DMG

1 of 2

APPR:TWK:CP:03-22-18
FHWA:APPR:03-29-18

a. Description. This work consists of furnishing and installing acceptable alternatives to inlet protection devices (devices) listed in the *Soil Erosion and Sedimentation Control Manual* when the pay item Erosion Control, Inlet Protection, Fabric Drop is included in the contract.

This work consists of providing all labor, equipment and materials necessary to furnish, install, maintain, dispose of collected material and remove devices at the locations shown on the plans or as directed by the Engineer.

b. Materials. The following devices are approved for use as acceptable alternatives:

1. Siltsack Type B, Regular Flow, by ACF Environmental, Inc.
2. Inlet Pro Sediment Bag, Standard Flow, with optional foam deflector by Hanes Geo Components.
3. Dandy Curb Bag, Dandy Bag, Dandy Curb Sack, Dandy Sack, or Dandy Pop by Dandy Products, Inc.
4. Basin Bag, Regular Flow by CSI Geoturf.
5. Flexstorm Catch-It and Flexstorm Pure used with filter bag types FX, FX+, FXO, PC, PC+ or IL.

Ensure provided devices are sized appropriately for the drainage structures in which they will be installed.

c. Construction. Install, maintain and remove the devices according to the manufacturer's guidelines. Remove material collected by the devices according to the manufacturer's guidelines or as directed by the Engineer.

Dispose of collected material in accordance with subsection 205.03.P of the Standard Specifications for Construction. Those devices that are no longer needed and have been removed may be reused elsewhere on the project as approved by the Engineer.

d. Measurement and Payment. The completed work, as described, will be measured and paid for at the contract unit price using the following pay item:

Pay Item	Pay Unit
Erosion Control, Inlet Protection, Fabric Drop.....	Each

Erosion Control, Inlet Protection, Fabric Drop will be paid for as one each for each time the alternate device listed herein is installed, maintained, and removed at a separate location within the project limits.

MICHIGAN
DEPARTMENT OF TRANSPORTATION

SPECIAL PROVISION
FOR
AGGREGATE BASE COURSE

CFS:JAR

1 of 1

APPR:JAR:ACR:06-26-03
FHWA:APPR:04-19-11

a. Description. This provision modifies the layer thickness requirements for placing and compacting aggregate base course. Delete the 6-inch maximum layer restriction in section 302 of the Standard Specifications for Construction and replace with the following:

Construct a test strip at the start of base work. Compact all layers to a uniform depth of not more than 10 inches (+3/4 inch). If the total plan base thickness exceeds 10 inches, construct the base in layers of equal thickness. Secure the Engineer's approval for the method of placement and compaction before continuing.

If the accepted method is subsequently modified, the Engineer may require another test strip to confirm compliance with the specification. The Engineer may remove a portion of a layer when conducting density testing to assure the compaction requirements are being met full-depth.

b. Measurement and Payment. All additional costs associated with constructing aggregate base course according to this special provision will be included in the related Aggregate Base pay item.

MICHIGAN
DEPARTMENT OF TRANSPORTATION

SPECIAL PROVISION
FOR
WRAPPING CULVERT AND STORM SEWER JOINTS

CFS:DMG

1 of 1

APPR:TRK:DBP:05-31-18
FHWA:APPR:05-31-18

Delete the last two sentences in the first paragraph of subsection 401.03.C, on page 185 of the Standard Specifications for Construction, and replace with the following:

Wrap all culvert pipe joints with geotextile blanket regardless of size and material type. The geotextile blanket must be at least 36 inches wide and installed on the pipe exterior, centered on the joint. The ends of the geotextile blanket must overlap by at least 12 inches.

Delete the last two sentences in the first paragraph of subsection 402.03.C, on page 195 of the Standard Specifications for Construction, and replace with the following:

Wrap all sewer pipe joints with geotextile blanket regardless of size and material type. The geotextile blanket must be at least 36 inches wide and installed on the pipe exterior, centered on the joint. The ends of the geotextile blanket must overlap by at least 12 inches.

MICHIGAN
DEPARTMENT OF TRANSPORTATION

SPECIAL PROVISION
FOR
CULVERT AND SEWER BEDDING AND BACKFILL

BRG:TRK

1 of 2

APPR:JJG:DMG:09-21-15
FHWA:APPR:10-05-15

Delete subsection 401.03.A, on page 185 of the Standard Specifications for Construction, in its entirety and replace with the following:

A. **Excavation and Culvert Bedding.** Excavate in accordance with subsection 206.03.A. Construct pipe culvert bedding using granular material Class IIIA. Bedding must be placed at least 4 inches thick and uncompacted for the entire length of the culvert. Where rock or hardpan is encountered, excavate the trench to at least 6 inches below the proposed bottom of the pipe; place bedding using uncompacted granular material Class IIIA.

Where unstable soil conditions, or obstructions other than rock, require excavation of the trench below the elevation detailed on the plans; undercut, backfill, and compact the trench as directed by the Engineer. Use 6A, 17A, or 34R aggregate as backfill material for undercutting due to unstable soil conditions. Use 34R aggregate for bedding material in lieu of granular material Class IIIA. Place the backfill up to approximately 4 inches below the proposed bottom of the pipe. This work will be paid for as trench undercut and backfill according to subsection 402.04.E.

Delete subsection 401.03.D, on page 187 of the Standard Specifications for Construction, in its entirety and replace with the following:

D. **Backfilling.** Backfill culverts, within the limits of the roadbed, with granular material Class II, III, or IIIA. Place backfill in layers no greater than 10 inches thick and compact each layer to at least 95 percent of the maximum unit weight.

Backfill culvert downspouts, culverts, or portions of culvert outside the limits of the roadbed with granular or suitable material as detailed on the plans. Compact thoroughly as directed by the Engineer. Maintain at least 3 feet of cover, unless trimming for final grade.

Backfill smooth lined CPE and CPV with granular material Class IIIA to at least 1 foot above the pipe and as shown on the plans. The Engineer may allow the use of Class II, Class III or suitable material as backfill above this elevation. Place the backfill in layers no greater than 10 inches. Place the backfill equally on opposite sides of the pipe at the same time.

Stake, or use other methods to maintain the line and grade of the culvert during the backfilling operation.

Delete the last sentence of the second paragraph of subsection 402.03.A, on page 195 of the Standard Specifications for Construction, and replace with the following:

Place bedding using uncompacted granular material Class IIIA to the required elevation.

Delete the third paragraph of subsection 402.03.A, on page 195 of the Standard Specifications for Construction, and replace with the following:

Where unstable soil conditions, or obstructions other than rock, require excavation of the trench below the elevation detailed on the plans; undercut, backfill, and compact the trench as directed by the Engineer. Use 6A, 17A, or 34R aggregate as backfill material for undercutting due to unstable soil conditions. Use 34R aggregate for bedding material in lieu of granular material Class IIIA. Place the backfill up to approximately 4 inches below the proposed bottom of the pipe. This work will be paid for as trench undercut and backfill according to subsection 402.04.E.

MICHIGAN
DEPARTMENT OF TRANSPORTATION

SPECIAL PROVISION
FOR
SAMPLING ASPHALT BINDER ON LOCAL AGENCY PROJECTS

CFS:MF

1 of 1

APPR:JAR:JTL:12-19-01
FHWA:CON. APPR:06-06-11

For informational purposes, original samples of asphalt binder will be taken by the Contractor and delivered to the Engineer prior to incorporation into the mixture. The frequency of sampling will be determined by the Engineer. The cost of obtaining and delivering the samples to the Engineer will be included in the hot mix asphalt (HMA) pay items.

The Contractor must certify in writing that the materials used in the HMA mixture are from the same source as the materials used in developing the HMA mixture design and the bond coat is from an approved supplier as stated in the *Material Quality Assurance Procedures Manual*.

MICHIGAN
DEPARTMENT OF TRANSPORTATION

SPECIAL PROVISION
FOR
RECYCLED HOT MIX ASPHALT MIXTURE ON LOCAL AGENCY PROJECTS

CFS:KPK

1 of 2

APPR:JWB:CJB:03-13-14
FHWA:APPR:03-13-14

Add the following subsection to subsection 501.02.A.2, on page 234 of the Standard Specifications for Construction.

- c. **Reclaimed Asphalt Pavement (RAP) and Binder Grade Selection.** The method for determining the binder grade in HMA mixtures incorporating RAP is divided into three categories designated Tier 1, Tier 2 and Tier 3. Each tier has a range of percentages that represent the contribution of the RAP binder toward the total binder, by weight. The tiers identified below apply to HMA mixtures with the following exception: Superpave mixture types E3, E3 High Stress, E10, E10 High Stress, E30, E30 High Stress, E50, and E50 High Stress used as leveling or top course must be limited to a maximum of 27 percent RAP binder by weight of the total binder in the mixture.

Recycled materials may be used as a substitute for a portion of the new materials required to produce HMA mixtures in accordance with contract.

- **Tier 1 (0% to 17% RAP binder by weight of the total binder in the mixture).** No binder grade adjustment is made to compensate for the stiffness of the asphalt binder in RAP.
- **Tier 2 (18% to 27% RAP binder by weight of the total binder in the mixture).** For all mixtures no binder grade change will occur in Tier 2 for all shoulder and temporary road mixtures.

The required asphalt binder grade must be at least one grade lower for the low temperature than the design binder grade required for the specified project mixture type. Lowering the high temperature of the binder one grade is optional. For example, if the design binder grade for the mixture type is PG 58-22, the required grade for the binder in the HMA mixture containing RAP would be a PG 52-28 or a PG 58-28.

For Marshall Mixes, no binder grade change will be required when Average Daily Traffic (ADT) is above 7000 or Commercial Average Daily Traffic (CADT) is above 700. No binder grade change will occur for LVSP, E03 and E1 mixtures used as leveling or top course.

The asphalt binder grade can also be selected using a blending chart for high and low temperatures. Supply the blending chart and the RAP test data used in determining the binder selection according to *AASHTO M 323*.

- **Tier 3 (\geq 28% RAP binder by weight of the total binder in the mixture).** The binder

grade for the asphalt binder is selected using a blending chart for high and low temperatures per *AASHTO M 323*. Supply the blending chart and the RAP test data used in determining the binder selection.

MICHIGAN
DEPARTMENT OF TRANSPORTATION

SPECIAL PROVISION
FOR
MARSHALL HOT MIX ASPHALT MIXTURE

CFS:JWB

1 of 2

APPR:EHR:CJB:09-25-06
FHWA:APPR:06-06-11

a. Description. Furnish hot mix asphalt (HMA) mixture, designed using Marshall Mixture Design Methods, in accordance with the standard specifications except as modified by this special provision.

b. Mix Design. Submit the mix design for evaluation in accordance with the Department's HMA Production Manual. Use a 50 blow Marshall hammer when compacting mixtures for developing Marshall mix designs.

c. Recycled Mixtures. Substituting reclaimed asphalt pavement (RAP) for a portion of the new material required to produce HMA mixture is allowed provided that the mixture is designed and produced to meet all criteria specified herein, unless otherwise prohibited. RAP materials must be in accordance with the standard specifications.

d. Materials. Table 1 provides the mix design criteria and volumetric properties. Table 2 provides the required aggregate properties. Use aggregates of the highest quality available to meet the minimum specifications. Use the mixture designation number shown in the contract item name when determining mix design properties from Tables 1 and 2.

e. Measurement and Payment. The completed work, as described, will be measured and paid for at the contract unit price using the following pay item:

Pay Item	Pay Unit
HMA, (type).....	Ton

Table 1: Mix Design Criteria and Volumetric Properties

	Mixture No.				
	2C	3C	4C	13A	36A
Target Air Void, % (a)	3.00	4.00	4.00	4.00	4.00
VMA (min) (b)	11.00	13.00	14.00	14.00	15.00
VFA	65-78	65-78	65-78	65-78	65-78
Fines to Binder Ratio (max) (c)	1.2	1.2	1.2	1.2	1.2
Flow (0.01 inch)	8 -16	8 -16	8 -16	8 -16	8 -16
Stability (min), lbs	1200	1200	1200	900	900
a. Lower target air voids by 1.00% if used in a separate shoulder paving operation. Consider reducing air void targets to 3.00% for lower traffic volume roadways when designing 13A and 36A mixtures for local agency use. b. VMA calculated using Gsb of the combined aggregates. c. Ratio of the weight of aggregate passing the No. 200 sieve to total asphalt binder content by weight; including fines and binder contributed by RAP.					

Table 2: Aggregate Properties

	Mixture No.				
	2C	3C	4C	13A	36A
	Percent Passing Indicated Sieve or Property Limit				
1½ inch	100				
1 inch	91-100	100			
¾ inch	90 max.	91-100	100	100	
½ inch	78 max.	90 max.	91-100	75-95	100
⅜ inch	70 max.	77 max.	90 max.	60-90	92-100
No. 4	52 max.	57 max.	67 max.	45-80	65-90
No. 8	15-40	15-45	15-52	30-65	55-75
No. 16	30 max.	33 max.	37 max.	20-50	
No. 30	22 max.	25 max.	27 max.	15-40	25-45
No. 50	17 max.	19 max.	20 max.	10-25	
No. 100	15 max.	15 max.	15 max.	5-15	
No. 200	3-6	3-6	3-6	3-6	3-10
Crushed (min), % (MTM 117)	90	90	90	25	60
Soft Particle (max), % (a)	12.0	12.0	8.0	8.0	8.0
Angularity Index (min) (b)	4.0	4.0	4.0	2.5	3.0
L.A. Abrasion (max), % loss (c)	40	40	40	40	40
Sand Ratio (max) (d)	-	-	-	50	50
<p>a. The sum of the shale, siltstone, structurally weak, and clay-ironstone particles must not exceed 8.0 percent for aggregates used in top course. The sum of the shale, siltstone, structurally weak, and clay-ironstone particles must not exceed 12.0 percent for aggregates used in base and leveling courses.</p> <p>b. The fine aggregate angularity of blended aggregates, determined by MTM 118, must meet the minimum requirement. In mixtures containing RAP, the required minimum fine aggregate angularity must be met by the virgin material. NAA fine aggregate angularity must be reported for information only and must include the fine material contributed by RAP if present in the mixture.</p> <p>c. Los Angeles abrasion maximum loss must be met for the composite mixture, however, each individual aggregate must be less than 50</p> <p>d. Sand ratio for 13A and 36A no more than 50% of the material passing the No. 4 sieve is allowed to pass the No. 30 Sieve.</p>					

MICHIGAN
DEPARTMENT OF TRANSPORTATION

SPECIAL PROVISION
FOR
LOW-TRACKING BOND COAT EMULSIFIED ASPHALT, PERMISSIVE USE

CFS:TRC

1 of 2

APPR:JWB:KPK:11-01-19
FHWA APPR:11-04-19

a. Description. This work consists of electing to furnish low-tracking bond coat emulsified asphalt in lieu of standard bond coat. Ensure all work is in accordance with section 904 of the Standard Specifications for Construction and applicable special provisions, except as modified herein. The low-tracking bond coat emulsified asphalt must conform to approved acceptance test methods and procedures described in the Materials Quality Assurance Procedures Manual. No deviations to acceptance test methods and procedures will be allowed.

b. Materials. The following types of low-tracking bond coat emulsified asphalt are allowed in lieu of the standard bond coat.

Table 1: Low-Tracking Bond Coat (LTBC) Emulsified Asphalt

Emulsified Asphalt Type	Specification Requirements
LTBC-1	Table 2
LTBC-2	Table 3

Table 2: Specification Requirements for LTBC-1

Parameter	Test Method	Minimum	Maximum
Saybolt Furol Viscosity, SFS @ 25 degrees C	<i>AASHTO T59</i>	15	150
Storage Stability, 24 Hrs, %	<i>AASHTO T59</i>	--	1
Storage Stability, 5 Days, %	<i>AASHTO T59</i>	--	5
Residue By Distillation, %	<i>AASHTO T59</i>	50	--
Oil Distillate, %	<i>AASHTO T59</i>	--	1
Sieve Test, %	<i>AASHTO T59</i>	--	0.30
Tests On Residue			
Penetration, @ 25 degrees C	<i>AASHTO T49</i>	--	20
Softening Point Range degrees C	<i>AASHTO T53</i>	60	--
Solubility, %	<i>AASHTO T44</i>	97.5	--

Table 3: Specification Requirements for LTBC-2

Parameter	Test Method	Minimum	Maximum
Saybolt Furol Viscosity, SFS @ 25 degrees C	AASHTO T59	15	100
Storage Stability, 5 Days, %	AASHTO T59	--	5
Residue By Distillation, %	AASHTO T59	50	--
Oil Distillate, %	AASHTO T59	--	1
Sieve Test, %	AASHTO T59	--	0.30
Tests On Residue			
Penetration, @ 25 degrees C	AASHTO T49	--	40
Solubility, %	AASHTO T44	97.5	--

c. Construction. Construct in accordance with subsection 501.03 of the Standard Specifications for Construction.

d. Measurement and Payment. When electing to substitute a low-tracking bond coat emulsified asphalt for the standard bond coat, it is with the understanding that the pay items in the original contract will not be changed and the low-tracking bond coat emulsified asphalt will be provided under those original pay items at the bid prices submitted.

MICHIGAN
DEPARTMENT OF TRANSPORTATION

SPECIAL PROVISION
FOR
ACCEPTANCE OF HOT MIX ASPHALT MIXTURE ON LOCAL AGENCY PROJECTS

CFS:KPK

1 of 7

APPR:CJB:JWB:07-05-16

FHWA:APPR:07-05-16

a. Description. This special provision provides sampling and testing requirements for local agency projects using the roller method and the nuclear density gauge testing. Provide the hot mix asphalt (HMA) mixture in accordance with the requirements of the standard specifications, except where modified herein.

b. Materials. Provide aggregates, mineral filler (if required), and asphalt binder to produce a mixture proportioned within the master gradation limits shown in the contract, and meeting the uniformity tolerance limits in Table 1.

Table 1: Uniformity Tolerance Limits for HMA Mixtures

Parameter		Top and Leveling Course		Base Course		
Number	Description	Range 1 (a)	Range 2	Range 1 (a)	Range 2	
1	% Binder Content	-0.30 to +0.40	±0.50	-0.30 to +0.40	±0.50	
2	% Passing	# 8 and Larger Sieves	±5.0	±8.0	±7.0	±9.0
		# 30 Sieve	±4.0	±6.0	±6.0	±9.0
		# 200 Sieve	±1.0	±2.0	±2.0	±3.0
3	Crushed Particle Content (b)	Below 10%	Below 15%	Below 10%	Below 15%	
a. This range allows for normal mixture and testing variations. The mixture must be proportioned to test as closely as possible to the Job-Mix-Formula (JMF). b. Deviation from JMF.						

Parameter number 2 as shown in Table 1 is aggregate gradation. Each sieve will be evaluated on one of the three gradation tolerance categories. If more than one sieve is exceeding Range 1 or Range 2 tolerances, only the one with the largest exceedance will be counted as the gradation parameter.

The master gradation should be maintained throughout production; however, price adjustments will be based on Table 1. Aggregates which are to be used in plant-mixed HMA mixtures must not contain topsoil, clay, or loam.

c. Construction. Submit a Mix Design and a JMF to the Engineer. Do not begin production and placement of the HMA until receipt of the Engineer's approval of the JMF. Maintain the binder content, aggregate gradation, and the crushed particle content of the HMA mixture within the Range 1 uniformity tolerance limits in Table 1. For mixtures meeting the definition of top or leveling course, field regress air void content to 3.5 percent with liquid asphalt cement unless

specified otherwise on HMA application estimate. For mixtures meeting the definition of base course, field regress air void content to 3.0 percent with liquid asphalt cement unless specified otherwise on HMA application estimate.

Ensure all persons performing Quality Control (QC) and Quality Assurance (QA) HMA field sampling are "Local Agency HMA Sampling Qualified" samplers. At the Pre-Production or Pre-Construction meeting, the Engineer will determine the method of sampling to be used. Ensure all sampling is done in accordance with *MTM 313 (Sampling HMA Paving Mixtures)* or *MTM 324 (Sampling HMA Paving Mixtures Behind the Paver)*. Samples are to be taken from separate hauling loads.

For production/mainline type paving, obtain a minimum of two samples, each being 20,000 grams, each day of production, for each mix type. The Engineer will sample and maintain possession of the sample. Sampling from the paver hopper is prohibited. Each sample will be divided into two 10,000 gram parts with one part being for initial testing and the other part being held for possible dispute resolution testing. Obtain a minimum of three samples for each mix type regardless of the number of days of production.

Obtain samples that are representative of the day's paving. Sample collection is to be spaced throughout the planned tonnage. One sample will be obtained in the first half of the tonnage and the second sample will be obtained in the second half of the tonnage. If planned paving is reduced or suspended, when paving resumes, the remaining sampling must be representative of the original intended sampling timing.

Ensure all persons performing testing are Bit Level One certified or Bit QA/QC Technician certified.

Ensure daily test samples are obtained, except, if the first test results show that the HMA mixture is in specification, the Engineer has the option of not testing additional samples from that day.

At the Pre-Production or Pre-Construction meeting, the Engineer and Contractor will collectively determine the test method for measuring asphalt content (AC) using *MTM 319 (Determination of Asphalt Content from Asphalt Paving Mixtures by the Ignition Method)* or *MTM 325 (Quantitative Extraction of Bitumen from HMA Paving Mixtures)*. Back calculation will not be allowed for determining asphalt content.

Ensure all labs performing local agency acceptance testing are qualified labs per the *HMA Production Manual* and participate in the MDOT round robin process, or they must be *AASHTO Materials Reference Laboratory (AMRL)* accredited for *AASHTO T 30* or *T 27*, and *AASHTO T 164* or *T 308*. Ensure on non-National Highway System (NHS) routes, Contractor labs are made available, and may be used, but they must be qualified labs as previously stated. Contractor labs may not be used on NHS routes. Material acceptance testing will be completed by the Engineer within 14 calendar days, except holidays and Sundays, for projects with less than 5,000 tons (plan quantity) of HMA and within 7 calendars days, except holidays and Sundays, for projects with 5,000 tons (plan quantity) or more of HMA, after the Engineer has obtained the samples. QA test results will be provided to the Contractor after the Engineer receives the QC test results. Failure on the part of the Engineer or the laboratory to provide Quality Assurance test results within the specified time frame does not relieve the Contractor of their responsibility to provide an asphalt mix within specifications.

The correlation procedure for ignition oven will be established as follows. Asphalt binder content based on ignition method from MTM 319. Gradation (*ASTM D 5444*) and Crushed particle content (*MTM 117*) based on aggregate from *MTM 319*. The incineration temperature will be established at the Pre-Production Meeting. The Contractor will provide a laboratory mixture sample to the acceptance laboratory to establish the correction factor for each mix. Ensure this sample is provided to the Engineer a minimum of 14 calendar days prior to production.

For production/mainline type paving, the mixture may be accepted by visual inspection up to a quantity of 500 tons per mixture type, per project (not per day). For non-production type paving defined as driveways, approaches, and patching, visual inspection may be allowed regardless of the tonnage.

The mixture will be considered out-of-specification, as determined by the acceptance tests, if for any one mixture, two consecutive tests per parameter, (for Parameter 2, two consecutive aggregate gradations on one sieve) are outside Range 1 or Range 2 tolerance limits. If a parameter is outside of Range 1 tolerance limits and the second consecutive test shows that the parameter is outside of Range 2, then it will be considered to be a Range 1 out-of-specification. Consecutive refers to the production order and not necessarily the testing order. Out-of-specification mixtures are subject to a price adjustment per the Measurement and Payment section of this special provision.

Contractor operations will be suspended when the mixture is determined to be out-of-specification, but contract time will continue to run. The Engineer may issue a Notice of Non-Compliance with Contract Requirements (Form 1165), if the Contractor has not suspended operations and taken corrective action. Submit a revised JMF or proposed alterations to the plant and/or materials to achieve the JMF to the Engineer. Effects on the Aggregate Wear Index (AWI) and mix design properties will be taken into consideration. Production and placement cannot resume until receipt of the Engineer's approval to proceed.

Pavement in-place density will be measured using one of two approved methods. The method used for measuring in-place density will be agreed upon at a pre-production or pre-construction meeting.

Pavement in-place density tests will be completed by the Engineer during paving operations and prior to traffic staging changes. Pavement in-place density acceptance testing will be completed by the Engineer prior to paving of subsequent lifts and being open to traffic.

Option 1 – Direct Density Method

Use of a nuclear density gauge requires measuring the pavement density using the Gmm from the JMF for the density control target. The required in-place density of the HMA mixture must be 92.0 to 98.0 percent of the density control target. Nuclear density testing and frequency will be in accordance with the *MDOT Density Testing and Inspection Manual*.

Option 2 – Roller Method

The Engineer may use the Roller Method with a nuclear or non-nuclear density gauge to document achieving optimal density as discussed below.

Use of the density gauge requires establishing a rolling pattern that will achieve the required in-place density. The Engineer will measure pavement density with a density gauge using the Gmm from the JMF for the density control target.

Use of the Roller Method requires developing and establishing density frequency curves, and meeting the requirements of Table 2. A density frequency curve is defined as the measurement and documentation of each pass of the finished roller until the in-place density results indicate a decrease in value. The previous recording will be deemed the optimal density. The Contractor is responsible for establishing and documenting an initial or QC rolling pattern that achieves the optimal in-place density. When the density frequency curve is used, the Engineer will run and document the density frequency curve for each half day of production to determine the number of passes to achieve the maximum density. Table 5, located at the end of this special provision, can be used as an aid in developing the density frequency curve. The Engineer will perform density tests using an approved nuclear or non-nuclear gauge per the manufacturer's recommended procedures.

Table 2: Minimum Number of Rollers Recommended Based on Placement Rate

Average Laydown Rate, Square Yards per Hour	Number of Rollers Required (a)	
	Compaction	Finish
Less than 600	1	1 (b)
601 - 1200	1	1
1201 - 2400	2	1
2401 - 3600	3	1
3601 and More	4	1

a. Number of rollers may increase based on density frequency curve.
b. The compaction roller may be used as the finish roller also.

After placement, roll the HMA mixture as soon after placement as the roller is able to bear without undue displacement or cracking. Start rolling longitudinally at the sides of the lanes and proceed toward the center of the pavement, overlapping on successive trips by at least half the width of the drum. Ensure each required roller is 8 tons minimum in weight unless otherwise approved by the Engineer.

Ensure the initial breakdown roller is capable of vibratory compaction and is a maximum of 500 feet behind the paving operations. The maximum allowable speed of each roller is 3 miles per hour (mph) or 4.5 feet per second. Ensure all compaction rollers complete a minimum of two complete rolling cycles prior to the mat temperature cooling to 180 degrees Fahrenheit (F). Continue finish rolling until all roller marks are eliminated and no further compaction is possible. The Engineer will verify and document that the roller pattern has been adhered to. The Engineer can stop production when the roller pattern is not adhered to.

d. Measurement and Payment. The completed work, as described, will be measured and paid for using applicable pay items as described in subsection 501.04 of the Standard Specifications for Construction, or the contract, except as modified below.

Base Price. Price established by the Department to be used in calculating incentives and adjustments to pay items and shown in the contract.

If acceptance tests, as described in section c. of this special provision, show that a Table 1 mixture parameter exceeds the Range 1, but not the Range 2, tolerance limits, that mixture parameter will be subject to a 10 percent penalty. The 10 percent penalty will be assessed based on the acceptance tests only unless the Contractor requests that the 10,000 gram sample part retained for possible dispute resolution testing be tested. The Contractor has 4 calendar days from receipt of the acceptance test results to notify the Engineer, in writing, that dispute resolution testing is requested. The Contractor's QC test results for the corresponding QA test results must result in an overall payment greater than QA test results otherwise the QA tests will not be allowed to be disputed. The Engineer has 4 calendar days to send the dispute resolution sample to the lab once dispute resolution testing is requested. The dispute resolution sample will be sent to an independent lab selected by the Local Agency, and the resultant dispute test results will be used to determine the penalty per parameter, if any. Ensure the independent lab is a MDOT QA/QC qualified lab or an AMRL HMA qualified lab. The independent lab must not have conflicts of interest with the Contractor or Local Agency. If the dispute testing results show that the mixture parameter is out-of-specification, the Contractor will pay for the cost of the dispute resolution testing and the contract base price for the material will be adjusted, based on all test result parameters from the dispute tests, as shown in Table 3 and Table 4. If the dispute test results do not confirm the mixture parameter is out-of-specification, then the Local Agency will pay for the cost of the dispute resolution testing and no price adjustment is required.

If acceptance tests, as described in section c. of this special provision, show that a Table 1 mixture parameter exceeds the Range 2 tolerance limits, the 10,000 gram sample part retained for possible dispute resolution testing will be sent, within 4 calendar days, to the MDOT Central Laboratory for further testing. The MDOT Central Laboratory's test results will be used to determine the penalty per mixture parameter, if any. If the MDOT Central Laboratory's results do not confirm the mixture parameter is out-of-specification, then no price adjustment is required. If the MDOT Central Laboratory's results show that the mixture is out-of-specification and the Engineer approves leaving the out-of-specification mixture in place, the contract base price for the material will be adjusted, based on all parameters, as shown in Table 3 and Table 4.

In the case that the Contractor disputes the results of the test of the second sample obtained for a particular day of production, the test turn-around time frames given would apply to the second test and there would be no time frame on the first test.

The laboratory (MDOT Central Laboratory or independent lab) will complete all Dispute Resolution testing and return test results to the Engineer, who will provide them to the Contractor, within 13 calendar days upon receiving the Dispute Resolution samples.

In all cases, when penalties are assessed, the penalty applies to each parameter, up to two parameters, that is out of specification.

Table 3: Penalty Per Parameter

Mixture Parameter out-of-Specification per Acceptance Tests	Mixture Parameter out-of-Specification per Dispute Resolution Test Lab	Price Adjustment per Parameter
NO	N/A	None
YES	NO	None
	YES	Outside Range 1 but not Range 2: decrease by 10%
		Outside Range 2: decrease by 25%

The quantity of material receiving a price adjustment is defined as the material produced from the time the first out-of-specification sample was taken until the time the sample leading to the first in-specification test was taken.

Each parameter of Table 1 is evaluated with the total price adjustment applied to the contract base price based on a sum of the two parameter penalties resulting in the highest total price adjustment as per Table 4. For example, if three parameters are out-of-specification, with two parameters outside Range 1 of Table 1 tolerance limits, but within Range 2 of Table 1 limits and one parameter outside of Range 2 of Table 1 tolerance limits and the Engineer approves leaving the mixture in place, the total price adjustment for that quantity of material is 35 percent.

Table 4: Calculating Total Price Adjustment

Cost Adjustment as a Sum of the Two Highest Parameter Penalties		
Number of Parameters Out-of-Specification	Range(s) Outside of Tolerance Limits of Table 1 per Parameter	Total Price Adjustment
One	Range 1	10%
	Range 2	25%
Two	Range 1 & Range 1	20%
	Range 1 & Range 2	35%
	Range 2 & Range 2	50%
Three	Range 1, Range 1 & Range 1	20%
	Range 1, Range 1 & Range 2	35%
	Range 1, Range 2 & Range 2	50%
	Range 2, Range 2 & Range 2	50%

Table 5: Density Frequency Curve Development

Tested by: _____ Date/Time: _____

Route/Location:		Air Temp:
Control Section/Job Number:		Weather:
Mix Type:	Tonnage:	Gauge:
Producer:	Depth:	Gmm:

Roller #1 Type:

Pass No.	Density	Temperature	Comments
1			
2			
3			
4			
5			
6			
7			
8			
Optimum			

Roller #2 Type:

Pass No.	Density	Temperature	Comments
1			
2			
3			
4			
5			
6			
7			
8			
Optimum			

Roller #3 Type:

Pass No.	Density	Temperature	Comments
1			
2			
3			
4			
5			
6			
7			
8			
Optimum			

Summary: _____

MICHIGAN
DEPARTMENT OF TRANSPORTATION

SPECIAL PROVISION
FOR
HOT MIX ASPHALT PRICES FOR ADJUSTMENTS

AA:DAD

1 of 1

APPR:MAS:KAS:03-05-19

a. Description. This special provision identifies the price(s) that will be used in all payment adjustments for work related to hot mix asphalt item(s) used in conjunction with this contract.

If the Contractors bid is lower than the established base price any positive adjustment will use the Contractors bid in the calculation for the adjustment. If the Contractors bid is lower than the established base price any negative adjustment will use the base price established herein in the calculation for the adjustment.

If the Contractors bid is higher than the established base price any positive adjustment will use the Contractors bid in the calculation for the adjustment. If the Contractors bid is higher than the established base price any negative adjustment will use the Contractors bid in the calculation for the adjustment.

b. Base Unit Prices. The base price(s) shown below will be used as specified above in calculating adjustments for the pay item(s) listed herein:

Pay Item Code	Pay Item Name	Unit	Base Price
5010025	Hand Patching	Ton	\$165.22
5010033	HMA, 13A	Ton	\$81.01
5010034	HMA, 36A	Ton	\$75.57
5010050	HMA, 4E1	Ton	\$62.00
5010051	HMA, 4E3	Ton	\$67.04
5010056	HMA, 5E1	Ton	\$65.60
5010057	HMA, 5E3	Ton	\$70.95
5010061	HMA Approach	Ton	\$101.64
5010509	HMA, 4E3, High Stress	Ton	\$66.74
5010515	HMA, 5E3, High Stress	Ton	\$74.84
5010520	HMA Approach, High Stress	Ton	\$101.24
5010703	HMA, LVSP	Ton	\$63.04

MICHIGAN
DEPARTMENT OF TRANSPORTATION

SPECIAL PROVISION
FOR
COLD MILLING CONCRETE PAVEMENT

DET:MPR

1 of 1

C&T:APPR:CJB:DMG:10-28-11

a. Description. This work consists of removing the top portion of the existing concrete pavement to the depth and cross section shown on the log or plans, and as directed by the Engineer.

b. Equipment. Use cold-milling machine(s) equipped with positive depth control adjustments and a positive means for controlling the cross slope. The cold-milling equipment must be capable of removing the chips from the pavement and preventing dust from escaping into the air.

c. Construction. Cold-mill the existing concrete pavement to the depth and cross section indicated on the log or plans, and as directed by the Engineer. Collect and dispose of the excess material resulting from the operations as specified in subsections 104.07.D and 204.03.B of the Standard Specifications for Construction. All costs associated with collecting and disposing of material picked up by sweeping after cold-milling will be borne by the Contractor.

Provide a final surface texture that is smooth and free of gouges, holes or large depressions. Prevent damage to the adjacent concrete. Where material is removed below the depth specified due to poor cold-milling practice, backfill and compact the resulting holes or depressions by hand patching in accordance with subsection 501.03.C.9 of the Standard Specifications for Construction. Repair all damage to adjacent surfaces as directed by the Engineer. All costs associated with this corrective work will be borne by the Contractor.

d. Measurement and Payment. The completed work, as described, will be measured and paid for at the contract unit price using the following pay item:

Pay Item	Pay Unit
Cold Milling Conc Pavt	Square Yard

Cold Milling Conc Pavt includes removing, loading, hauling and disposal of the material. This work will be measured by area in square yards regardless of the number of passes required to remove the concrete to the required depth.

MICHIGAN
DEPARTMENT OF TRANSPORTATION

SPECIAL PROVISION
FOR
PAVEMENT ACCEPTANCE FOR JOINTED PLAIN CONCRETE PAVEMENT

CFS:JFS

1 of 1

APPR:JAB:TES:05-18-11

FHWA:APPR:08-10-11

a. Description. This special provision defines the requirements for pavement acceptance that are in addition to those specified in section 602 of the Standard Specifications for Construction. When applicable, the condition for initial acceptance of the pavement according to the Materials and Workmanship Warranty still apply. This special provision does not relieve the Contractor of responsibility for the work according to subsection 107.11 of the Standard Specifications for Construction.

The Engineer will inspect the completed pavement for any visible indication of cracking. If cracking is found, decisions regarding corrective actions will be made jointly by the Engineer and the Construction Field Services Division, in accordance with Table 1.

All costs for the work required to repair or replace any unacceptable pavement are the responsibility of the Contractor. No time extensions will be granted to the Contractor for any required repair work to meet the requirements of this special provision.

For purposes of this special provision, a crack is defined as a fissure of varying length and orientation in the pavement that extends to some measurable depth. A crack may be a single entity or found in groups or clusters with possible associated distress features.

Table 1: Acceptance Factors and Corrective Action

Acceptance Factor	Length	Extent	Severity	Corrective Action (a)(d)
LC	any	single/multiple	all	Replace slab (b)
TC - \geq 1.5 ft. from TJ	any	single/multiple	all	Replace slab (b)
TC - $<$ 1.5 ft. from TJ	any	single/multiple	all	Replace joint (c)
LC = longitudinal crack		TJ = transverse joint		
TC = transverse crack				
<p>a. Repair must establish an acceptable transverse load transfer of efficiency greater than 90%.</p> <p>b. An appropriate corrective treatment (based on the specific crack's characteristics, its location relative to a longitudinal or transverse joint, and the corrective treatment's contribution toward the pavement's intended service life) may be proposed by the Contractor in lieu of full slab replacement. The Contractor's corrective treatment proposal is subject to approval by the Engineer.</p> <p>c. Full-depth PCC repair. FDR must be 6 feet long, minimum, by the entire lane width according to Standard Plan Series R-44. Install contraction joints (Type Crg) at both transverse joint locations.</p> <p>d. Do not overcut into the adjacent lane or shoulder.</p>				

MICHIGAN
DEPARTMENT OF TRANSPORTATION

SPECIAL PROVISION
FOR
CURING CONCRETE PAVEMENT SURFACES

CFS:JFS

1 of 3

APPR:ARB:TES:10-23-19
FHWA:APPR:10-29-19

a. Description. This work sets forth requirements for curing horizontal and vertical surfaces of the concrete pavement. All work will be in accordance with the standard specifications, except as modified herein.

Curing requirements for temporary concrete pavements are not covered by this special provision and will be in accordance with the standard specifications.

b. Materials. Curing materials are specified in subsection 903.06.A of the Standard Specifications for Construction.

c. Construction. For concrete pavements other than temporary applications the following requirements apply.

1. Curing. Curing operations will take precedence over texturing in accordance with subsection 602.03.K of the Standard Specifications for Construction.

Include details for the operation and oversight of curing in the approved Quality Control (QC) plan.

The curing period will commence immediately after application of curing compound and must be continuously maintained until the pavement concrete attains the opening to traffic flexural strength.

Use the fully-automatic, self-propelled mechanical atomizing power sprayer approved by the Engineer to apply the curing compound. Operate the equipment to direct the curing compound onto the surface from two different lateral directions. Do not allow the sprayer to ride on the pavement surface. Ensure the sprayer covers the entire pavement horizontal and vertical surfaces with no puddling, dripping, or non-uniform application occurs.

A foot bridge, or other means, may be used to apply curing compound for concrete pavements and shoulders less than 24 feet wide. Ensure the atomizing mechanical sprayer is capable of uniformly applying the curing compound at the specified rate and timeliness, as described in this special provision.

Do not commence concrete paving until it is demonstrated to the Engineer that the curing materials and personnel are on site and the curing equipment is fully operational.

Maintain a thoroughly mixed compound in accordance with the manufacturer's recommendations. Do not dilute curing compound.

Protect curing compounds from freezing before application.

Temporarily suspend paving operations if it is observed that the curing operations are not in conformance with specification requirements. Resume paving only after action has been taken to correct deficiencies and it has been demonstrated that the corrective action will ensure contract compliance moving forward.

2. Time of Application. Place the curing compound within 30 minutes of screeding and floating the fresh concrete pavement surface or within 15 minutes after the sheen from bleed water has dissipated, whichever is greater. Where applicable, apply the second coat after the first coat dries, but do not allow more than 2 hours between coats. Temporarily suspend paving operations if it is observed that the maximum time limitations between finishing and curing, described above, have been exceeded. Place the curing compound on the edges within 30 minutes after permanent removal of curing blankets. If fixed-forms are removed within 7 days after concrete placement, coat the sides of the pavement with curing compound after removing the forms. Manually operated pressure-type sprayers may be used to coat the sides of formed pavement with curing compound, as approved by the Engineer.

3. Rate of Application. Apply one coat of curing compound at a minimum application rate of 1 gallon per 16 square yards on non-grooved surfaces and two coats at a minimum application rate of 1 gallon per 25 square yards for each coat on grooved surfaces. For grooved surfaces, apply the first coat within the required time of application, described above.

4. Uniformity of Application. Apply curing compound homogeneously to provide a uniform, solid, white opaque coverage on all exposed concrete surfaces (equal to a white sheet of typing paper). Immediately reapply curing compound to surfaces damaged by rain, tracking of the joint saw, Contractor foot traffic, or other activities. If the Engineer determines that the initial or corrective spraying results in unsatisfactory curing, the Engineer may require the Contractor to use the blanket curing method, at no additional cost to the Department.

Replace concrete showing damage due to inadequate curing, at no additional cost to the Department.

5. Protection from Cold Weather. If using cold-weather protection during the curing period, curing compound may be temporarily omitted, if approved by the Engineer.

Protect the concrete pavement from freezing for the entire curing period. Application of curing compound at the minimum rate specified in section c of this special provision is then required immediately after removal of cold-weather protection. Remove and replace concrete slabs damaged by cold weather, as directed by the Engineer, at no additional cost to the Department.

d. Acceptance. Pavement surfaces not in compliance with the curing requirements described in this special provision will be subject to a price adjustment (ADJ). A unit of pavement representing the area for price adjustment (ADJ) will include the entire width of concrete placement times the length of concrete that is not in compliance, as determined by the Engineer. Acceptance will be based on conformance with the time of application, rate of application, and uniformity of application described in section c of this special provision. One or more of the following criteria will warrant price adjustment (ADJ) for a unit of pavement.

1. Time of Application. Price adjustment (ADJ) will apply to all concrete surfaces not

receiving timely application of curing compound, irrespective of conformance with the rate or uniformity criteria.

2. Rate of Application. Price adjustment (ADJ) will apply to concrete surfaces not receiving the specified rate of curing compound within the specified time of application.

3. Uniformity of Application. Price adjustment (ADJ) will apply to concrete surfaces not uniformly coated at the minimum rate of application within the specified time of application.

ADJ = minus one dollar (- \$1.00) per square yard of finished concrete surface.

Positive price adjustment (ADJ) does not apply.

e. Measurement and Payment. All costs associated with this work will be included in the respective concrete pavement items.

Price adjustment (ADJ) described in section d of this special provision will apply to the respective concrete pavement item.

MICHIGAN
DEPARTMENT OF TRANSPORTATION

SPECIAL PROVISION
FOR
**QUALITY CONTROL AND ACCEPTANCE OF PORTLAND CEMENT CONCRETE
(FOR LOCAL AGENCY PROJECTS ONLY)**

CFS:JFS

1 of 21

APPR:TES:DBP:06-14-19
FHWA:APPR:06-14-19

a. Description. The Contractor must administer quality control (QC) and the Department will administer quality assurance (QA) procedures that will be used for acceptance of and payment for all Portland cement concrete (PCC) for the project. Except as explicitly modified by this special provision, all materials, test methods, and PCC mixture requirements of the standard specifications and the contract apply.

Do not place concrete until the Engineer's daily startup testing verifies that the fresh concrete properties have been met, in accordance with subsection d.2 of this special provision.

Provide the Engineer a minimum 24 hours notification prior to each concrete placement.

1. Terminology.

Air Content of Fresh Concrete. The recorded total air content of fresh concrete sampled and tested according to this special provision.

Air Content Test Results. The recorded air content of fresh concrete corresponding to the strength test specimens that were molded for acceptance.

Alkali-Silica Reactivity (ASR). A chemical reaction which occurs over time within concrete between high alkaline cement paste and reactive forms of silica found in some aggregates. In the presence of moisture, an expansive ASR gel is formed which can exert pressure within the concrete, causing random cracking and premature deterioration of the concrete. See subsection c.5.A of this special provision.

Base Price. Price established by the Department to be used in calculating incentives or adjustments to pay items and shown in the contract.

Concrete Mix Design. The process, by which the concrete mixture performance characteristics are defined, based on selected materials, performance requirements, environmental exposure considerations, placement methods, and other factors that control the plastic and hardened properties of the concrete in efforts to produce an economical and durable product.

Job Mix Formula (JMF). The actual batch quantities (mixture proportions) of each constituent included in the concrete mixture, based on adjustments to the target weights attained from the mix design process, necessary to optimize the concrete mixture properties.

Pay Factor (PF). The factor that is determined according to subsections d.3 of this special provision, used to calculate the price adjustment for a discrete quantity of concrete relative

to its respective level of quality. Pay factor will not exceed 1.00. Therefore, there will never be a positive pay adjustment.

Price Adjustment (ADJ). The price adjustment applied to the quantity of concrete represented by the respective quality index analysis described in subsections d.3 of this special provision.

Production Lot. A discrete cubic yard quantity of concrete containing the same JMF and used for the same application, as described in subsection d.2 of this special provision.

Quality Assurance (QA). Activities administered by the Engineer dealing with acceptance of the product, including, but not limited to, materials selection, sampling, testing, construction inspection, and review of Contractor QC documentation. All concrete QA sampling and testing will be administered by the Department. Department administered QA is described in section d of this special provision.

Quality Control (QC). All activities administered by the Contractor to monitor, assess, and adjust production and placement processes to ensure the final product will meet the specified levels of quality, including, but not limited to, training, materials selection, sampling, testing, project oversight and documentation. Contractor administered QC is described in section c of this special provision.

QC Action Limits. A range of values established by the Contractor in the QC plan that, if exceeded, requires that corrective action be taken by the Contractor to restore the continuity and uniformity of the mixture and methods in conformance with specification requirements. The QC action limits must not exceed the QC suspension limits.

QC Plan. The project-specific plan developed by the Contractor describing, in detail, all aspects of production and construction for the project to ensure consistent control of quality to meet specification requirements.

QC Plan Administrator. An employee of, or consultant engaged by the Contractor, responsible for developing and overseeing all aspects of QC for the project. This includes, but is not limited to preparing the QC plan, managing the Contractor QC personnel, communicating routinely with the production personnel to ensure quality, initiating corrective action and suspending operations when the process is found to be producing non-conforming materials, and preparing and submitting all necessary QC documentation to the Engineer within the specified time period.

QC Suspension Limits. A range of values defined in Table 1 that, if exceeded on a single QC test, requires that the Contractor suspend operations and determine, correct, and document the deficiencies before resuming production. The QC suspension limit must not exceed specification requirement thresholds.

Sample. A representative quantity of concrete taken during production which is used to measure the quality characteristics for the concrete.

Sampling Rate. The number of times the fresh concrete is sampled, as described in subsection d.2 of this special provision.

Small Incidental Quantity. A single day's placement of less than 20 cubic yards of concrete used for non-structural or non-pavement related applications, including, but not limited to:

curb and gutter, sidewalks and sidewalk ramps (excluding driveways and driveway ramps), installing sign or fence posts, guard rail or cable rail foundations (excluding end anchorage foundations), or other contract items where the small quantity of concrete is not paid for separately, as approved by the Engineer. Requirements for small incidental quantity consideration are described in subsections c.5.G, d.2.B and d.3 of this special provision. The corresponding weekly QA test results must meet specification limits defined in Table 3.

Specification Limits. The threshold values placed on a quality characteristic used to evaluate the quality of the material.

Strength Sample Test Result. The average of the two companion 28-day compressive strength test specimens taken from the same sample of concrete is considered a strength sample test result.

Strength Test Specimen. A strength test specimen is an individual 6-inch by 12-inch strength test cylinder or 4-inch by 8-inch strength test cylinder molded and cured according to *AASHTO T23/ASTM C 31* and tested according to *AASHTO T22/ASTM C 39*. All respective QC or QA strength test specimens must be the same nominal size. Strength test specimen cylinder size of 4-inch by 8-inch is permitted only if the nominal maximum coarse aggregate particle size, as specified for the coarse aggregate in the concrete mixture, is 1-inch, or less.

Sublot. A portion of a production lot, represented by a complete set of QA tests, as described in subsection d.2.A of this special provision. The Engineer and the Contractor may agree to reduce the typical subplot size based on project staging or other project conditions.

Supplementary Cementitious Materials (SCM). A mineral admixture (slag cement, fly ash) used to replace a portion of the Portland cement, either individually or as a blended cement, in the concrete mixture. SCM requirements are described in subsection c.5 of this special provision.

b. Materials. Mixture requirements must be in accordance with the contract.

c. Contractor Administered Quality Control (QC).

1. Contractor Quality Control Plan (QC plan). Prepare, implement, and maintain a QC plan specific to the project for concrete that will provide quality oversight for production, testing, and control of construction processes. The QC plan must be in conformance with the contract and must identify all procedures used to control production and placement including when to initiate corrective action necessary to maintain the quality and uniformity of the work.

Develop concrete mix designs and JMFs, as specified, and conduct QC sampling, testing, and inspection during all phases of the concrete work at the minimum frequency, or at an increased frequency sufficient to ensure that the work conforms to specification requirements.

Project-specific items required in the QC plan include (where applicable), but are not limited to the following:

A. Organization chart.

- B. QC Plan Administrator and contact information.
- C. The name(s) and credentials of the QC staff.
- D. Methods for interaction between production and QC personnel to engage timely corrective action, including suspension of work.
- E. Coordination of activities.
- F. Documentation, procedures, and submittals.
- G. Project and plant specifics.
- H. Concrete production facilities inspections and certifications.
- I. Current testing equipment calibration documentation including calibration factor.
- J. Testing and initial field curing facilities for QC and QA strength test specimens (AASHTO T23/ASTM C 31).
- K. Stockpile management plan.
- L. Corrective action plan.
- M. Mixing time and transportation, including time from batching to completion of delivery and batch placement rate (batches per hour), along with the manufacturer's documentation relative to the batching equipment's capabilities in terms of maximum mixing capacity and minimum mixing time (*ASTM C 94*).
- N. Placement and consolidation methods including monitoring of vibration, depth checks, and verification of pavement dowel bar alignment.
- O. Process for monitoring stability of air content of fresh concrete during concrete production and placement.
- P. Hot and cold weather protection considerations and methods.
- Q. Control charts with action and suspension limits.
- R. Verification for non-deleterious alkali-silica reactivity (see subsection c.5.A of this special provision).
- S. Mix design and JMFs.
- T. Proposed production lot size and location for use of each JMF on the project.
- U. The frequency of sampling, testing, and yield verification.
- V. Handling, protection, initial curing, and transporting of strength test specimens (*AASHTO T23/ASTM C31*).

- W. Methods to monitor construction equipment loading and open-to-traffic strengths.
- X. Finishing and curing procedure.
- Y. Ride quality control.
- Z. List of QC records to be submitted to the Engineer in accordance with subsection c.2 of this special provision.

Submit the QC plan, for the appropriate items of work, to the Engineer for review a minimum of 10 working days before the start of related work. The Engineer will notify the Contractor of any objections relative to the content of the QC plan within 5 working days of receipt of the QC plan. Do not begin concrete placement before acceptance of the QC plan by the Engineer. If the approved QC plan fails to provide acceptable work, or acceptable control of the work, the Engineer may require the Contractor to revise the QC plan. Revisions to the QC plan must be approved by the Engineer prior to resuming work.

2. QC Records. Maintain complete records of all QC tests and inspections. Document what action was taken to correct deficiencies. Include sufficient information to allow the test results to be correlated with the items of work represented.

Furnish one copy of all QC records, including test reports for the fresh concrete placement, to the Engineer within 24 hours after the date covered by the record in a format acceptable to the Engineer. The Engineer will withhold acceptance of the concrete for failure to provide properly documented and timely QC records and reports.

If the Engineer is performing QA sampling and testing at the same time the Contractor is performing QC sampling and testing, all associated QC records must include the appropriate production lot identification number that correlates with the Department's QA production lot identification number.

3. Personnel Requirements. The QC Plan Administrator must have full authority and responsibility to take all actions necessary for the successful implementation of the QC plan, including but not limited to, the following:

A. Monitoring and utilizing QC tests, control charts, and other QC practices to ensure that delivered materials and proportioning meets specification requirements.

B. Monitoring materials shipped to the project, prior to their use, to ensure their continued compatibility toward producing consistent quality.

C. Periodically inspecting all equipment utilized in transporting, proportioning, mixing, placing, consolidating, finishing, and curing to ensure proper operation.

D. Monitoring materials stockpile management, concrete batching, mixing, transporting, placement, consolidation, finishing, and curing to ensure conformance with specification requirements.

E. Maintaining and submitting all QC records and reports.

F. Directing the necessary corrective action to ensure continual conformance within

the QC action limits.

G. Suspending production for the project when suspension limits are exceeded.

H. Conducting or monitoring adjustments to the JMF.

Individuals performing QC tests must demonstrate that they are proficient and capable of sampling and testing concrete or aggregate, where applicable, in accordance with the associated test procedures and Department requirements prior to commencement of related work. Any adjustments to the JMF must be made by a certified concrete technician (Michigan Concrete Association (MCA) Michigan Level II).

4. QC Laboratory Requirements. Laboratories, including field laboratories and all associated testing equipment that prepare concrete mixes or perform QC testing, must demonstrate to the Engineer that they are equipped, staffed, calibrated, and managed so as to be capable of batching, and testing PCC in accordance with the applicable test methods and procedures. Mix designs and their accompanying JMFs must include a statement, signed by a certified concrete technician (MCA Michigan Level II), that all applicable standard test methods have been followed in verifying the mix design and JMF.

5. Mix Design and Documentation. Design concrete mixtures meeting the requirements specified in Table 1. Provide the grade of concrete for the section number reference application specified in Table 1, or as specified in the contract. Request variance in writing when proposing a mix design that exhibits temperature, slump or air content other than those specified. Include the proposed mix design, JMF, and associated trial batch verification test data. Do not use a grade of concrete with a lower specification limit (LSL) 28-day compressive strength greater than what is designated for the application.

Blended cement meeting the requirements of *ASTM C 595 Type II* is permitted.

Ensure supplementary cementitious materials are from an MDOT Approved Manufacturer. Slag cement must meet the requirements of subsection 901.06 of the Standard Specifications for Construction. Fly ash must meet the requirements of subsection 901.07 of the Standard Specifications for Construction.

Secure prior approval from the Engineer to use concrete intended for early opening to traffic to facilitate driveway gaps or other features necessary for required local access.

Unless otherwise specified in the contract, set accelerating admixtures are prohibited.

Optimized aggregate gradation is required for high performance concrete and concrete mixtures that are placed using a pump. Concrete mixtures for tremie and drilled shaft applications do not require optimized aggregate gradation. The physical requirements for coarse and intermediate aggregates specified in subsection 902.03.C of the Standard Specifications for Construction apply to high performance concrete pavement mixtures. The physical requirements for aggregates used in concrete mixtures for all other applications will be according to the contract.

Unless otherwise specified in the contract, provide either concrete Grade P1 or Grade D for bridge approach slab applications.

Unless otherwise specified in the contract, do not exceed 40 percent replacement of the Portland cement in the concrete mixture with a supplementary cementitious material. Do not exceed 40 percent total replacement of the Portland cement if more than one supplementary cementitious material is used in the concrete mixture.

Use the combined weight of all cementitious materials to determine compliance with the maximum water-cementitious ratio and cementitious material content requirements specified in Table 1.

For night casting, where applicable, a water-reducing admixture may be used in lieu of a water-reducing and retarding admixture, provided the concrete can be placed and finished in the sequence specified on the plans prior to initial set, is not subjected to residual vibration, or is not within the areas influenced by dead load deflections as a result of adjacent concrete placement operations. When the maximum air temperature is not forecast to exceed 60 degrees F for the day, the Contractor may use a water-reducing admixture or a water-reducing retarding admixture.

Table 1: Minimum Mix Design Requirements for Concrete

Mix Design Parameter	Grade of Concrete																												
	P1M (a,b,e)	P1 (a,b)	D,DM (a,b,e)	T	S1 (a)	S2,S2M (a,b,e)	S3/P2 (a)																						
Lower Specification Limit (LSL) (28-day compressive, psi)	3500	3500	4500	3500	4000	3500	3000																						
Rejection Limit for an Individual Strength Sample Test Result	3000	3000	4000	3000	3500	3000	2500																						
Maximum Water/Cementitious Ratio (lb/lb) (c)	0.45																												
Cementitious Material Content (lb/yd ³) (d)	470-564	517-611	517-658	517-611	517-611	517-611	489-517																						
Air Content (percent) (f)	5.5-8.5																												
Slump (inch) (max.)	(g)																												
Section Number Reference (h)	602, 603	602, 603, 801, 802, 803, 810	706, 711, 712	706, 718	705	401, 706, 712, 713, 718, 801, 802, 803, 810, 819	402, 403, 602, 803, 804, 806, 808, 810, 813, 814																						
<p>a. If the local average minimum temperature in the next 10 consecutive days is forecast to be below 40 degrees F, submit a revised QC plan for the Engineer's approval, addressing in detail changes in materials, concrete batching and mixing processes, construction methods, curing, and protection of the in situ concrete to ensure that the necessary quality characteristics of the hardened concrete product will not be compromised as a result of the cold weather. The revised QC plan must be approved by the Engineer prior to cold weather concrete placement. Do not remove supplementary cementitious material from the concrete mixture.</p> <p>b. Use aggregates from only geologically natural sources for pavement, shoulder, miscellaneous pavement (including ramps), concrete pavement overlay, bridge approach slab, structural concrete, drilled shaft, bridge railing, and bridge sidewalk applications.</p> <p>c. Use admixtures as listed in the Qualified Products Lists to reduce mixing water. Ensure concrete in concrete diaphragms contains a water-reducing admixture, or a water-reducing retarding admixture.</p> <p>d. Type III cement is not permitted.</p> <p>e. For grades of concrete requiring optimized gradation, aggregates must meet the physical requirements specified in subsection 902.03.C of the Standard Specifications for Construction.</p> <p>f. For action, suspension, and specification limits, see Tables 2 and 3, where applicable.</p> <p>g. The maximum slump for Grades P1, P1M, and P2 concrete is 3 inches or as documented on the approved JMF. All other grades of concrete will be according to Table 701-1 of the Standard Specifications for Construction.</p>																													
<p>h. Section Number Reference:</p> <table border="0"> <tr> <td>401 Pipe Culverts</td> <td>402 Storm Sewers</td> </tr> <tr> <td>403 Drainage Structures</td> <td>602 Concrete Pavement Construction</td> </tr> <tr> <td>603 Concrete Pavement Restoration</td> <td>705 Foundation Piling</td> </tr> <tr> <td>706 Structural Concrete Construction</td> <td>711 Bridge Railings</td> </tr> <tr> <td>712 Bridge Rehabilitation-Concrete</td> <td>713 Bridge Rehabilitation-Steel</td> </tr> <tr> <td>718 Drilled Shafts</td> <td>801 Concrete Driveways</td> </tr> <tr> <td>802 Concrete Curb, Gutter and Dividers</td> <td>803 Concrete Sidewalk, Sidewalk Ramps, and Steps</td> </tr> <tr> <td>804 Concrete Barriers and Glare Screens</td> <td>806 Shared Use Paths</td> </tr> <tr> <td>808 Fencing</td> <td>810 Permanent Traffic Signs and Supports</td> </tr> <tr> <td>813 Slope Protection</td> <td>814 Paved Ditches</td> </tr> <tr> <td>819 Electrical and Lighting</td> <td></td> </tr> </table>								401 Pipe Culverts	402 Storm Sewers	403 Drainage Structures	602 Concrete Pavement Construction	603 Concrete Pavement Restoration	705 Foundation Piling	706 Structural Concrete Construction	711 Bridge Railings	712 Bridge Rehabilitation-Concrete	713 Bridge Rehabilitation-Steel	718 Drilled Shafts	801 Concrete Driveways	802 Concrete Curb, Gutter and Dividers	803 Concrete Sidewalk, Sidewalk Ramps, and Steps	804 Concrete Barriers and Glare Screens	806 Shared Use Paths	808 Fencing	810 Permanent Traffic Signs and Supports	813 Slope Protection	814 Paved Ditches	819 Electrical and Lighting	
401 Pipe Culverts	402 Storm Sewers																												
403 Drainage Structures	602 Concrete Pavement Construction																												
603 Concrete Pavement Restoration	705 Foundation Piling																												
706 Structural Concrete Construction	711 Bridge Railings																												
712 Bridge Rehabilitation-Concrete	713 Bridge Rehabilitation-Steel																												
718 Drilled Shafts	801 Concrete Driveways																												
802 Concrete Curb, Gutter and Dividers	803 Concrete Sidewalk, Sidewalk Ramps, and Steps																												
804 Concrete Barriers and Glare Screens	806 Shared Use Paths																												
808 Fencing	810 Permanent Traffic Signs and Supports																												
813 Slope Protection	814 Paved Ditches																												
819 Electrical and Lighting																													

A. Alkali-Silica Reactivity. Provide documentation to the Engineer that the concrete mixture does not present the potential for deleterious expansion caused by alkali-silica reactivity (ASR). Provide current ASR test results (valid for 2 years from completion of testing), for the fine aggregate that is proposed to be used in the concrete, from an independent testing laboratory proficient in ASR testing. The independent testing laboratory must certify in writing, including a signed statement that all testing was conducted in accordance with the designated standard test procedures, described herein. Test results must conform to the specified criterion for one of the following standard test methods. ASR testing is not required for concrete pavement repairs and temporary concrete pavements. Use the Rounding Method described in *ASTM E 29* when determining significant digits for reporting expansion test results.

(1) Method 1. *ASTM C 1293*. Concrete Prism Test. If the expansion of concrete prisms is not greater than 0.040 percent (rounded to the nearest 0.001 percent) after 1 year, the fine aggregate is considered non-deleterious to ASR and may be used in the JMF.

(2) Method 2. *ASTM C 1567*. Mortar Bar Test. If no previous test data are available for the fine aggregate that shows it is resistant to ASR using Method 1, above, replace 25 to 40 percent of the Portland cement in the concrete mixture with a supplementary cementitious material. A blended cement meeting the requirements of *ASTM C 595* containing the above Portland cement and supplementary cementitious material proportions may also be used.

Demonstrate the ability of the supplementary cementitious material to control the deleterious expansion caused by ASR by molding and testing mortar bars according to the standard test method described in *ASTM C 1567* using the mix proportions and constituent sources for both the aggregates and the cementitious materials that will be used for the project. Make at least three test specimens for each cementitious materials-aggregate combination. If the average of three mortar bars for a given cementitious materials-aggregate combination produces an expansion less than 0.10 percent (rounded to the nearest 0.01 percent) at 14 days of immersion, the JMF associated with that combination will be considered non-deleterious to ASR. If the average expansion is 0.10 percent (rounded to the nearest 0.01 percent) or greater, the JMF associated with that combination will be considered not sufficient to control the deleterious expansion caused by ASR and the JMF will be rejected.

(3) Method 3. *ASTM C 1260*. Mortar Bar Test. If the expansion of the mortar bars is less than 0.10 percent (rounded to the nearest 0.01 percent) at 14 days of immersion, the fine aggregate is considered non-deleterious to ASR and may be used in the concrete without the need for ASR mitigation.

The Engineer will not approve the use of the JMF if the expansion exceeds the respective threshold limits for the respective ASTM test method used.

B. Contractor Provided Mixes. Provide mix design and accompanying JMFs using the methods of verification included in this special provision. Include sufficient information on constituent materials and admixtures along with trial batch verified physical properties of the fresh concrete, mix proportions per cubic yard for all constituents and compressive strength test results necessary to allow the Engineer to

fully evaluate the expected performance of the concrete mixture.

(1) Mix Documentation. Prepare mix designs for each grade of concrete required on the project. Submit JMF for each mix design, including all required documentation, to the Engineer for review 10 working days before the anticipated date of placement. The Engineer will notify the Contractor of any objections within 5 working days of receipt of the mix documentation. Number or otherwise identify each JMF and reference all accompanying documentation to this identification. Reference each JMF to the appropriate method of verification. Mix design and JMF submittals that do not include all required documentation will be considered incomplete and the Engineer will return them without review.

Mix documentation is valid for 2 years provided the material characteristics have not deviated beyond the requirements specified in the contract.

All mix designs and accompanying JMFs must be traceable to a laboratory meeting the requirements of this special provision.

Submit mix design and JMF on the MDOT Job Mix Formula (JMF) Concrete Field Communication form (MDOT Form Number 1976); include accompanying documentation. List the source of materials, bulk density (unit weight) of coarse aggregate (rodding procedure or shoveling procedure), absorption of aggregates, relative density (specific gravity) of aggregates, aggregate correction factors, batch weights, and project specific or historical laboratory test data. Include the recorded air content of fresh concrete using the same admixture and cementitious material sources to be used in the production of the concrete for the project. A JMF will be approved only if all of the minimum mix design requirements specified in the contract have been met.

(2) Job Mix Formula (JMF). Select proportions for concrete mixtures according to *ACI Standard 211.1*. The volume (oven-dry-rodded) of coarse aggregate per unit volume of concrete must be 65 percent, minimum.

Four methods of verification of proposed JMF are acceptable.

(a) Method 1. Trial Batches. Verification of JMF is based on trial batches with the same materials and proportions proposed for use on the project. Prepare at least one trial batch for each mix design in sufficient time before starting concrete placement to allow for review according to subsection c.5.B.(1) of this special provision. Provide the results of temperature, slump, density (unit weight), air content of fresh concrete, 28-day compressive strength, and age of concrete at the time of strength testing, for a minimum of three independent samples. All samples may be taken from a single trial batch for a mix design provided the trial batch is at least four cubic yards in volume. For JMF trial batch verification purposes only, 7-day compressive strength test results which report at least 70 percent of the specified 28-day lower specification limit (LSL) will be sufficient documentation in lieu of 28-day compressive strengths. The average of at least two strength test specimens represents one compressive strength sample test result for each independent sample. Provide the necessary ASR documentation as described in subsection c.5.A of this special provision.

(b) Method 2. Same Mix. Verification of JMF is based on the concrete producer's experience with the same mix design, JMF, and the same materials. Provide the results of temperature, slump, density (unit weight), air content of fresh concrete, 28-day compressive strength, and age of concrete at the time of strength testing, for a minimum of three independent samples. The average of at least two strength test specimens represents one compressive strength sample test result for each independent sample. Do not substitute material types or sources, including admixtures or cementitious materials, nor change mix proportions in the JMF. Provide the necessary ASR documentation as described in subsection c.5.A of this special provision.

(c) Method 3. Similar Mix. Verification of JMF is based on requirements described in Method 2, in subsection c.5.B.(2).(b) of this special provision. Substitution of coarse aggregate source is permitted if the new source is of the same geologic type as the original aggregate, and conforms to the specification requirements for the application. Substitution of fine aggregate is permitted only if the new source has been tested for ASR. Provide the necessary ASR documentation as described in subsection c.5.A of this special provision.

Provide the supporting laboratory trial batch documentation and accompanying calculations showing how the mix proportions in the JMF were adjusted, based on the documented differences in relative density (specific gravity), bulk density (unit weight) and absorption of the substituted aggregate sources, to produce a theoretical yield of 100 percent and the required fresh concrete properties.

(d) Method 4. Annual Verification. At the Engineer's option, verification may be accepted annually for a concrete producer rather than on a project basis provided the sources and proportions of the constituent materials, including cementitious materials and source and types admixtures, do not change. If the project is the continuation of work in progress during the previous construction season and written certification is submitted to the Engineer that materials from the same source and with the same mixture properties are to be used, the Engineer may waive the requirement for annual renewal verification of the JMF for the project. Provide the necessary ASR documentation as described in subsection c.5.A of this special provision.

C. Department Provided Mixes. Unless otherwise specified in the contract or approved by the Engineer, the Engineer will provide the concrete JMF for the following types of concrete regardless of the total quantity for the project.

- (1) Structural concrete patching mixtures, mortar and grout.
- (2) Bridge deck overlay concrete mixtures.
- (3) Project-specific concrete mixtures and grades not defined in Table 1.

Provide all other mix designs and accompanying JMF's according to subsection c.5.B of this special provision.

The ASR documentation for the fine aggregate described in subsection c.5.A of this special provision must accompany the Contractor's request for the concrete JMF.

D. Changes in Materials and Proportions. Any changing from one approved JMF to another for the same grade of concrete must have prior approval by the Engineer.

Prior to batching, verify that the proposed JMF changes will not affect the properties of the fresh concrete (slump, temperature, air content, density (unit weight), workability), nor result in deleterious mortar bar expansion as a result of ASR, as described in subsection c.5.A of this special provision.

Record all changes to JMF in the QC records along with the rationale for the change.

E. QC Sampling and Testing. Conduct startup sampling and testing for temperature, slump, density (unit weight), and air content on the first load. Do not place concrete until testing verifies that the fresh concrete properties have not exceeded the QC action and suspension limit thresholds specified in Table 2 and the testing correlation requirements of subsection d.1.B of this special provision have been met. Continue testing subsequent loads as described in the QC plan, for each grade of concrete delivered to the work site each day. The QC sampling and testing must be random and independent from the Agencies QA sampling and testing.

Provide the curing facilities in accordance with subsection d.2.C of this special provision prior to start of concrete production.

Perform QC sampling and testing for air content of fresh concrete that is either slipformed or pumped, as described in the QC plan. Sample and test a representative haul unit of concrete immediately after its discharge but before the slipform paver or pump hopper, where applicable. Sample and test the concrete representing the same haul unit, again, after the slipform paver or after discharge from the pump (without interruption or alteration of the pumping operation), where applicable. If the difference in measured air content between the two test locations for the same concrete is greater than 1.5 percent air by volume of concrete, suspend operations and administer corrective action. Resume concrete placement only after taking the necessary corrective action to reduce the loss in air content of fresh concrete between the two test locations, as approved by the Engineer. Document the corrective action to be taken in the QC records and make the necessary changes to the QC plan, where applicable.

Concrete exceeding the maximum specification limits for slump or temperature must be rejected regardless of the total mixing time at the time of arrival to the project.

The Engineer may require the Contractor to administer additional QC sampling and testing if the Engineer determines the Contractor's current QC sampling and testing methodology is shown to be insufficient to ensure continual control of the quality of the concrete.

Take the appropriate corrective action, as described in the QC plan, when QC testing shows the QC action limits for any quality characteristic are exceeded. Suspend production if any of the QC suspension limits are exceeded or if the corrective action is not sufficient to restore the quality to acceptable levels.

Resume production only after making all necessary adjustments to bring the mixture into conformance with all applicable specifications and receiving approval to resume work

from the Engineer. Document these adjustments in the QC records.

Table 2: QC Action and Suspension Limits

Quality Characteristic	Action Limits	Suspension Limits
Air Content (percent)	See Note Below	< 5.0 or > 9.0
Air Content Loss (percent)	As Defined in the Contractor QC plan	Greater than 1.5
Conc. Temp. (Deg. F)		< 45 or > 90 at time of placement
Slump (max.) (inch)		See Table 1, footnote (g)
Density (unit weight)		N/A
Note: Action limits must be defined in the Contractor QC plan and cannot be < 5.5 or > 8.5. Suspend work if air content is < 5.0 or > 9.0 percent after pump or paver, regardless of the air content loss.		

F. Work Progress Test Specimens. Determine the strength of concrete for opening to construction traffic or regular traffic, for removing shoring and forms, or for similar purposes in accordance with subsections 104.11, 601.03.H and 701.03.D of the Standard Specifications for Construction, and as approved by the Engineer. Cure work progress test specimens in the same manner as the in-situ concrete. Allow the Engineer to witness testing of work progress test specimens.

The maturity method may be used to determine the in-place, opening-to-traffic flexural strength, provided the necessary preliminary flexural strength versus time-temperature factor correlation, using the same materials and JMF, is established according to Department procedures and approved by the Engineer before placing the concrete.

G. Reduced QC for Small Incidental Quantities. If approved by the Engineer, reduced levels of on-site QC testing for concrete may be considered for small incidental quantities defined in subsection a.1 of this special provision.

Unless approved by the Engineer, multiple small incidental quantities, including ones that are consecutively placed throughout the project on the same day, are not eligible for reduced QC consideration if the total plan quantity of concrete for the item exceeds 100 cubic yards in volume. Include details for reduced QC testing and oversight in the approved QC plan, and in accordance with following:

(1) The small incidental quantity of concrete will be limited to a single day's concrete placement of a maximum 20 cubic yards in volume.

(2) The small incidental quantity of concrete is not an integral part of a structural load bearing element.

(3) The Engineer received written certification from the Contractor that the concrete supplier has a current QC plan in place and available for review upon request by the Engineer.

(4) The concrete supplier employs a certified concrete technician (MCA Michigan Level II) available at the plant or on call during concrete placement to validate and authorize modifications to the concrete JMF, as necessary.

(5) Prior to the first concreting operation, concrete representing the JMF for the small incidental quantity has been sampled and tested by a certified concrete technician (MCA Michigan Level I or II) to verify that, historically, the JMF produced a

concrete mixture meeting the minimum requirements for density (unit weight), slump, air content, and strength. Annual verification may be acceptable provided there are no changes to the material types or sources, including the cementitious materials and admixtures.

(6) The Engineer verified that the temperature, slump, and air content conform to specification requirements at the start of the day's concreting operation associated with the small incidental quantity.

(7) The Engineer is notified and provided sufficient opportunity to witness concrete placement.

d. Department Administered Quality Assurance (Acceptance).

1. Department Quality Assurance Plan (QA plan). The Engineer will be responsible for administering the quality-based acceptance and will institute any actions necessary toward its successful implementation.

Acceptance of concrete pavement repair mixtures and concrete mixtures not included in Table 1 will be in accordance with the contract.

The Engineer will develop and follow a QA plan. The Engineer will provide the QA plan to the QC Plan Administrator a minimum of 5 working days prior to the pre-production meeting. The QA plan will be reviewed at the pre-production meeting and any proposed changes will be documented.

The nominal QA strength test specimen size, defined in subsection a.1 of this special provision will be noted in the QA plan.

A. Personnel Requirements. The personnel responsible for field inspection and for obtaining QA samples will possess the required qualifications to collect QA samples. Sampling will be performed by a certified concrete technician (MCA Michigan Level I or II) or (MCAT) certified aggregate technician, where applicable.

B. Testing Correlation. Prior to initial concrete placement, the testing personnel for both the Engineer's QA and Contractor's QC will use the equipment they have assigned to the project to conduct side by side correlation testing of the same concrete used on the project to verify correlation of both the Department's and the Contractor's test results for temperature and air content of fresh concrete. Additional side by side correlation testing will be conducted whenever there is a change in QC or QA equipment and/or testing personnel for the project, or as directed by the Engineer. The temperature measuring devices used for QC and QA must correlate with each other within 2 degrees F. If the air content results of the side by side tests conducted by the QC and QA testers and equipment differ by more than 0.8 percent air by volume of concrete, a referee air content test of fresh concrete must be conducted by a third party, designated by the Engineer but independent of the project, prior to commencement or continuation of concrete placement in efforts to resolve issues associated with non-correlation.

C. Laboratory Facilities. The testing laboratory with responsibility for acceptance testing on this project is the Department testing laboratory, or a qualified facility under the authority of the Engineer.

2. QA Sampling and Testing. The Engineer will verify the Contractor's daily startup sampling and testing of temperature, slump, and air content of fresh concrete on the first load; conduct QA sampling and testing; monitor Contractor adherence to the QC plan; and inspect field placed materials in such a manner as to ensure that all concrete for the project is represented. The testing correlation requirements of subsection d.1.B of this special provision must be met prior to concrete placement.

The following *ASTM* test methods will apply. The Department's established procedures for sampling and testing are acceptable alternatives.

C 31 Practice for Making and Curing Concrete Test Specimens in the Field

C 39 Test Method for Compressive Strength of Cylindrical Concrete Specimens

C 78 Test Method for Flexural Strength of Concrete (Using Simple Beam with Third-Point Loading)

C 138 Test Method for Density (Unit Weight), Yield and Air Content (Gravimetric) of Concrete

C 143 Test Method for Slump of Hydraulic-Cement Concrete

C 172 Practice for Sampling Freshly Mixed Concrete

C 173 Test Method for Air Content of Freshly Mixed Concrete by the Volumetric Method

C 231 Test Method for Air Content of Freshly Mixed Concrete by the Pressure Method

C 293 Test Method for Flexural Strength of Concrete (Using Simple Beam with Center-Point Loading)

A. Lot Size and Make Up. A production lot will not include more than one grade of concrete, concrete of the same grade having different specified slump or air content, or concrete of the same grade having different mix designs, or JMFs. Lot size and makeup will be determined by the Engineer, based on site conditions. A production lot may consist of a single day's production, individual concrete structural elements (eg. footing, column, pier cap, deck, bridge approach slab), or any combination thereof, provided they are of the same JMF. Each production lot will be divided into sublots of approximately equal size, as determined by the Engineer. The minimum number of sublots will be one per production lot, with the maximum number of sublots based on the anticipated total quantity of concrete to be placed and site conditions. A minimum of one subplot will be required for each day of production.

B. Sampling. QA sampling and testing will be conducted by the Engineer during concrete placement. Where practical, the random number method (as described in the "Random Sampling for Quality Control/Quality Assurance Projects" section of the Materials Quality Assurance Procedures Manual) will be used to determine the sampling locations. The sampling rate will be determined by the Engineer, based on the anticipated total quantity of concrete to be placed and site conditions, with a minimum of one sampling for each day of production.

At the option of the Engineer, small incidental quantities as defined in subsection a.1 of this special provision may be accepted (visually inspected and noted on the Inspector's Daily Report) without daily 28-day compressive strength QA test specimens provided there is a current acceptable strength test history of the JMF for the project prior to placement of the small incidental quantity. One set of compressive strength QA test specimens will then be molded for each small incidental quantity JMF at least once per week during production, thereafter, as determined by the Engineer (note the test results or identification number for the corresponding weekly QA compressive strength test result on the Inspector's Daily Report for each small incidental quantity). Quality control testing and daily QA testing for temperature, slump, and air content of fresh concrete are still required. Reduced QC for small incidental quantities, as described in subsection c.5.G of this special provision, may be considered.

The QA sampling rate and sample location will be based on cubic yard quantities.

Samples for acceptance will be taken at the point of discharge from the haul unit, at approximately the middle one-third of the load. Mix adjustments to the concrete contained within the haul unit selected for QA sampling and testing (beyond normal QC) will not be permitted prior to QA sampling and testing. QA sampling will be random and without prior notification.

The Engineer will perform QA sampling and testing for air content loss of fresh concrete that is either slipformed or pumped, (1) at least once during each day of production, (2) whenever the concrete pump is relocated, where applicable, or (3) whenever there is a significant change in the boom configuration or operation of the concrete pump, or there is a significant change in the characteristics of the paving operation during concrete placement. Concrete will be sampled from a representative haul unit immediately after its discharge but before the slipform paver or pump hopper, where applicable. The concrete representing the same haul unit will then be sampled and tested after the slipform paver or after discharge from the pump (without interruption or alteration of the pumping operation), where applicable. If the difference in measured air content between the two test locations for the same concrete is greater than 1.5 percent air by volume of concrete, the Engineer will issue a Notice of Non-Compliance with Contract Requirements (Form 1165), as described in subsection d.2.D of this special provision. The Contractor may resume concrete placement only after the necessary corrective action is taken to reduce the loss in air content of fresh concrete between the two test locations, as approved by the Engineer. Document the corrective action that was taken by the Contractor.

C. Testing. The location(s) within the project limits for QA testing of the fresh concrete and placement of curing facilities for initial curing of the 28-day compressive strength QA test cylinders will be determined by the Engineer in conformance with the following criteria:

(1) The elapsed time between obtaining the first and the final portion of the composite sample must not exceed 15 minutes.

(2) Testing for slump, temperature, and air content of fresh concrete must begin within 5 minutes after obtaining the final portion of the composite sample.

(3) Molding of the 28-day compressive strength QA test cylinders must begin within 15 minutes after obtaining the final portion of the composite sample.

(4) The concrete sample must be protected from the sun, wind, and other sources of rapid evaporation, and from contamination.

Two QA concrete strength test specimens per sample will be molded for 28-day compressive strength QA testing.

The Contractor will provide curing facilities equipped to ensure the proper environment for the Agencies QA concrete strength test specimens during initial cure. Each initial cure facility must provide ventilation or insulation, where applicable, to ensure the ambient temperature surrounding the specimens is maintained according to *AASHTO T23/ASTM C 31*. Failure by the Contractor to maintain the proper curing environment during initial cure will not be basis for rejection of samples or claims against the Department. Each initial curing facility must be capable of being locked, using an Department provided padlock. The Contractor will ensure that all initial curing facilities are accounted for at all time, and protected against theft and damage. The Contractor will place and secure each initial cure facility throughout the project limits in such a manner so as to minimize excessive transport of the test specimens prior to initial cure, as follows:

(5) Immediately after finishing molded specimens, the Engineer will move the QA concrete strength test specimens to the closest initial cure facility provided by the Contractor.

(6) Immediately after all QA concrete strength test specimens are placed into the cure facility and the proper initial curing conditions have been established, the Engineer will secure the facility using the Department provided padlock. Access to the QA concrete strength test specimens, thereafter, must be coordinated with the Engineer and will only be permitted in the presence of the Engineer.

(7) The Engineer will transport the QA concrete strength test specimens within 48 hours after molding, but not prior to 8 hours after final set of the concrete, from the initial curing facility to the Department's designated testing laboratory for final curing and strength testing. The specimens will be protected with a suitable cushioning material to prevent damage from jarring during transport. The total transportation time must not exceed 4 hours prior to commencement of final curing.

D. QA Stop Production Criteria. The Engineer will issue a Notice of Non-Compliance with Contract Requirements (Form 1165) and concrete production must stop when one or more of the following are observed.

(1) The QA testing shows that one or more of the suspension limits for quality characteristics defined in Table 2 are in non-compliance.

(2) The QC plan is not being followed.

(3) Segregation, excessive slumping of unsupported slipformed edges, or other notable changes in the fresh concrete properties is observed that may prevent proper placement, consolidation and finishing, or compromise the performance or long-term durability of the finished product.

(4) The required curing system is not being applied in a timely manner, as specified by the contract.

(5) If the measured air content loss between the two testing locations for the same concrete is greater than 1.5 percent air by volume of concrete as described in subsections c.5.E and d.2.B of this special provision.

(6) If the air content of fresh concrete is less than 5.0 or greater than 9.0 percent after pump or paver, regardless of the recorded QC or QA air content loss through the pump or paver.

The Engineer will issue a Notice to Resume Work (Form 1165) only after all necessary adjustments are made to restore conformance with all applicable specifications, and the appropriate documentation is made in the QC records.

E. QA Records. The Engineer will maintain a complete record of all QA tests and inspections. The records will contain, as a minimum, signed originals of all QA test results and raw data, random numbers used (where applicable) and resulting calculations. The QA test results will not be provided to the Contractor until the corresponding QC test results are received by the Engineer.

3. Quality Index Analysis. The Engineer's QA test results will be used to determine the pay factor (PF) and price adjustment (ADJ). The Contractor's QC test results will not be used for pay factor and price adjustment analysis. The Engineer will complete pay factor and price adjustment analysis within 7 working days after completion of all 28-day compressive strength testing for the representative production lot or quantity of concrete. The quality index parameter specification limits are defined in Table 3. Unless otherwise specified in the contract, concrete not conforming to the requirements specified in Table 3 is rejectable and subject to further evaluation. All values of PF and OLPF in these formulae are decimal, not percent. All values of PF and OLPF are rounded to two decimal places.

Price adjustment for 28-day compressive strength deficiencies will be based on test results for the corresponding weekly QA test specimens and the pay factor (PFs) calculated according to the formula defined in subsection d.3.A. The price adjustment (ADJ) = (PFs – 1)(Price).

Table 3: Quality Index Parameter Specification Limits

Quality Characteristic	Specification Limits
Air Content of Fresh Concrete (percent)	5.5 – 8.5
Rejection Limit (percent)	<5.0 or >9.0
Conc. Temp. (deg. F)	45 - 90 at time of placement
Slump (max.) (inch)	See Table 1, footnote (g)
28-day Compressive Strength (psi)	For LSL see Table 1
Rejection Limit - 28-day Compressive Strength	See Table 1

A. Pay Factor for 28-Day Compressive Strength (PFs).

$$PFs = \frac{\text{Tested Strength}}{\text{LSL}}$$

Where:

PFs = Pay Factor for 28-day compressive strength (not to exceed 1.00)

Tested Strength = QA 28-day compressive strength sample test result

LSL = Lower specification limit (see Table 1)

If the tested strength does not meet the rejection limit specified in Table 1, the Engineer will require additional evaluation as described in subsection d.4 of this special provision.

B. Pay Factor for Air Content of Fresh Concrete (PFac). The pay factor for air content of fresh concrete (PFac) will be according to Table 4.

Table 4: Air Content of Fresh Concrete Pay Factor (PFac)

Air Content of Fresh Concrete (percent)	Pay Factor (PFac)
5.5 – 8.5	1.00
5.0 – 5.4	0.50
Below 5.0	Rejection
8.6 – 9.0	0.75
Above 9.0	Rejection

If the air content of fresh concrete is below 5.0 or above 9.0 percent, the Engineer will elect to do one of the following.

(1) Require removal and replacement of the entire quantity of concrete represented by the test with new testing conducted on the replacement concrete and repeat the evaluation procedure.

(2) Allow submittal of a corrective action plan for the Engineer's approval. If the Engineer does not approve the plan for corrective action, subsection d.3.B.(1) of this special provision will be applied. All costs associated with plan submittal and corrective action under this subsection will be borne by the Contractor.

C. Overall Lot Pay Factor (OLPF). The following formulae are used to calculate the OLPF and ADJ. The OLPF will not exceed 1.00.

$$\text{OLPF} = (0.60 \times \text{PFs}) + (0.40 \times \text{PFac})$$

$$\text{ADJ} = (\text{OLPF} - 1)(\text{Price})$$

ADJ = Price adjustment per pay unit to be applied to the quantity represented by the QA test

Price = Base price established for the pay item

4. Evaluation of Rejectable Concrete. The Engineer will require additional evaluation to decide what further action may be warranted, as described below. Acceptance for air content of fresh concrete will be based on QA test results reported at the time of concrete placement.

If the Engineer determines that non-destructive testing (NDT) is appropriate, this work will be

done by the Contractor in the presence of the Engineer within 45 calendar days from concrete placement. All costs associated with this work will be borne by the Contractor. A complete set of non-destructive tests must be conducted (in accordance with the respective standard test method) at a minimum three randomly selected locations. If NDT is used to estimate the in-situ strength, a calibrated relationship between the project JMF under evaluation and the NDT apparatus must have been established prior to NDT testing according to its respective standard test method.

If the 28-day compressive strength QA test results show that the rejection limit (as specified in Table 1) has not been achieved, the quantity of concrete under evaluation will be rejected and the Engineer will require additional evaluation to decide what further action may be warranted.

Propose an evaluation plan and submit it to the Engineer for approval before proceeding. The results from NDT will be used only to decide what further action is required. This determination will be made by the Engineer, as follows:

A. For non-structural concrete. If no test result from non-destructive testing falls below the lower specification (LSL) 28-day compressive strength, the represented quantity of concrete under evaluation will remain in place and a pay factor for 28-day compressive strength (PFs) of 1.00 will be applied for overall lot pay factor (OLPF) and price adjustment (ADJ) determinations according to subsection d.3 of this special provision.

B. For structural concrete (including overhead sign foundations). If no test result from non-destructive testing falls below the lower specification limit 28-day compressive strength, the represented quantity of concrete under evaluation will remain in place and a pay factor for 28-day compressive strength (PFs) of 0.85 will be applied for overall lot pay factor (OLPF) and price adjustment (ADJ) determinations according to subsection d.3 of this special provision.

C. If one or more of the non-destructive test results fall below the lower specification limit (LSL) 28-day compressive strength, the Engineer may elect to do one of the following:

(1) Require removal and replacement of the entire rejected quantity of concrete, including new initial tests for pay factor (PF) determination and price adjustment conducted according to subsection d.3 of this special provision.

(2) Allow the Contractor to submit a plan for corrective action, for the Engineer's approval, to address the disposition of the rejected concrete. If the Engineer does not approve the plan for corrective action, subsection d.4.C.(1) of this special provision will be applied. All costs associated with plan submittal and corrective action under this subsection will be borne by the Contractor.

(3) Allow the in-situ quantity of concrete under evaluation to remain in place and a pay factor (PFs) of 0.50 will be applied for overall lot pay factor (OLPF) and price adjustment (ADJ) determinations according to subsection d.3 of this special provision.

e. Measurement and Payment. If a price adjustment is made for reasons included in this special provision, that adjustment will be made using the base price established for the specific item. If a contract unit price requires adjustment for other reasons not described in this special provision, the adjustments will be made using the unit price and the adjustments will be

cumulative.

Separate payment will not be made for providing, implementing, and maintaining an effective QC program. All costs associated with this work will be included in the applicable unit prices for the concrete items. Failure by the Contractor to maintain the proper curing environment during initial cure will not be basis for claim against the Department.

All costs associated with providing, locating, relocating, maintaining, and securing the adequate number of portable initial curing facilities for both the QC and QA strength test specimens will be included in the applicable unit prices for the concrete items. No additional payment will be permitted. The Contractor is responsible for damage, theft, subsequent replacement, and removal after completion of the work for each curing facility used on the project.

MICHIGAN
DEPARTMENT OF TRANSPORTATION

SPECIAL PROVISION
FOR
CURB RAMP OPENING, CONCRETE

DES:CAL

1 of 1

APPR:MB:DBP:04-10-17
APPR FHWA:04-17-17

Add the following new subsection 803.03.I, on page 543 of the Standard Specifications for Construction:

I. **Curb Ramp Opening.** Construct curb ramp openings in accordance with subsection 802.03 of the Standard Specifications for Construction, Standard Plan R-28 Series and as required to conform with the associated sidewalk ramp geometry (counter slope, running slope, cross slope, flares, widths, etc.).

Add the following pay item to the pay item listing in subsection 803.04, on page 544 of the Standard Specifications for Construction:

Curb Ramp Opening, ConcFoot

Delete the second paragraph of subsection 803.04.C, on page 544 of the Standard Specifications for Construction in its entirety and replace with the following:

The unit price for **Sidewalk Ramp, Conc, ___ inch** includes the cost of landings, monolithic rolled curbs or side flares along the longitudinal edges of the ramp or landing, and transitions to existing sidewalk.

Add the following new subsection 803.04.G, on page 545 of the Standard Specifications for Construction:

G. Curb Ramp Opening, Conc. The Engineer will measure **Curb Ramp Opening, Conc.** in place along the joint of the curbing with the pavement including transitions to and from adjacent standard full height curb and gutter cross section.

MICHIGAN
DEPARTMENT OF TRANSPORTATION

SPECIAL PROVISION
FOR
RECESSED PAVEMENT MARKINGS

PMK:MKB

1 of 2

APPR:MWB:MRB:02-05-19
FHWA:APPR:02-21-19

a. Description. This work consists of providing all equipment and labor required to prepare (grooving) the pavement surface for recessed longitudinal, transverse, and guide line pavement markings in accordance with section 811 of the Standard Specifications for Construction, the plans, and this special provision.

b. Materials. None specified.

c. Construction. Install a recess (groove) in accordance with the pavement marking material manufacturer's installation instructions. Ensure all recessing configurations are in accordance with the *MMUTCD* and the Department Pavement Marking Standards.

1. Grooving Concrete and Hot Mix Asphalt Pavement. If there are no markings on the pavement, it is the Contractor's responsibility to provide layout for exactly where the permanent markings will be placed. If there are temporary painted pavement markings, use these layout lines as a template for the grooving operation. If there are existing permanent pavement markings in place, remove them in accordance with 12SP-812P - Longitudinal Pavement Marking Removal prior to grooving operations.

Use equipment and methods approved by the manufacturer of the pavement marking material to be recessed for forming grooves in pavement surfaces. Dry-cut the grooves in a single pass using stacked diamond cutting heads on self-vacuuming equipment capable of producing a finished groove ready for pavement marking material installation.

Ensure that the bottom of the groove has a fine corduroy finish. If a coarse tooth pattern results, increase the number of blades and decrease the spaces on the cutting head until the required finish is achieved.

2. Groove Dimensions. Ensure grooves for recessed pavement markings are in accordance with the following:

Longitudinal Markings

Groove Width:	Material width +1 inch, ($\pm 1/8$ inch)
Groove Depth:	As recommended by the manufacturer, (± 5 mils)
Groove Position:	Center/Lane Lines: 2 inches from joint line, ($\pm 1/8$ inch) Edge Lines: On lane, 2-4 inches in from the joint line, ($\pm 1/8$ inch) Edge Lines for 14 foot paved lanes: as directed by the Engineer

Transverse Markings - Stop Bars, Crosswalks, and Cross Hatching

Groove Width:	Material width +1 inch, ($\pm 1/8$ inch)
Groove Depth:	As recommended by the manufacturer, (± 5 mils)

Groove Position: In the exact location where the transverse marking will be placed

Transverse Markings - Legends

Groove Width: For legends groove a rectangle encompassing the entire legend. The size of the rectangle must be the legend dimensions +1 inch ($\pm 1/8$ inch) on each side.

Groove Depth: As recommended by the manufacturer, (± 5 mils)

Groove Position: In the exact location where the transverse marking will be placed

Transverse Markings - Symbols

Groove Width: When grooving for arrow heads use a grinding head not larger than 7 inches in width and match the shape of the arrow head as closely as possible. For arrow stems and other symbols groove to the material shape +1 inch ($\pm 1/8$ inch) on each side. If the symbol shape cannot be followed, such as the bicycle and arrow symbols, determine an acceptable grooving layout with the Engineer.

Groove Depth: As recommended by the manufacturer, (± 5 mils)

Groove Position: In the exact location where the transverse marking will be placed

Guide Line Markings

Groove Width: Material width +1 inch, ($\pm 1/8$ inch)

Groove Depth: As recommended by the manufacturer, (± 5 mils)

Groove Position: In the exact location where the guide line markings will be placed

3. Placing Recessed Pavement Markings. Place the pavement marking material in the grooves within 24 hours of the grooves being made. Ensure the grooves are clean and dry prior to placing pavement marking material. Locate the groove so the entire marking can be placed within the groove.

d. Measurement and Payment. The completed work, as described, will be measured and paid for at the contract unit price using the following pay items:

Pay Item	Pay Unit
Recessing Pavt Mrkg, Longit.....	Foot
Recessing Pavt Mrkg, Transv.....	Square Foot
Recessing Pavt Mrkg, Guide Line.....	Foot

Recessing Pavt Mrkg, Longit; Recessing Pavt Mrkg, Transv; and Recessing Pavt Mrkg, Guide Line includes layout of the pavement markings, when required, and all work as described in this special provision.

Permanent pavement marking materials, temporary retroreflective pavement markings required for traffic control, and removal of existing permanent pavement markings will be paid for separately using the appropriate pay items.

MICHIGAN
DEPARTMENT OF TRANSPORTATION

SPECIAL PROVISION
FOR
PERMANENT PAVEMENT MARKINGS

PMK:MKB

1 of 3

APPR:MWB:CRB:02-05-19
FHWA:APPR:02-21-19

Add the following to the end of the list of materials in subsection 811.02, on page 588 of the Standard Specifications for Construction:

Modified Urethane Pavement Marking Material	920
Preformed Thermoplastic Pavement Marking Material	920

Ensure preformed thermoplastic materials for surface applications have a thickness of 90 mils and preformed thermoplastic materials for recessed applications have a thickness of 125 mils.

Add the following paragraph after the first paragraph of subsection 811.03.B, on page 589 of the Standard Specifications for Construction:

If pavement marking plan sheets and/or Witness, Log are included in the project the markings will be laid out by the Contractor prior to the permanent markings being applied. Layout is considered incidental to placement of permanent pavement markings. Provide the Engineer documented notice at least 2 calendar days prior to the Contractor pavement marking crew arriving onsite to layout and place the permanent pavement markings to enable the Engineer or a representative being onsite for review of the layout prior to the marking application. Notify the Engineer if it is discovered during layout that the pavement width or geometry has been altered or is different from the planned or logged configuration. The Contractor and Engineer will discuss and document the resolution for marking layout in such areas. If pavement marking plans and/or Witness, Log are not in the project, it is the responsibility of the Engineer to provide layout for the permanent pavement markings.

Add the following rows to Table 811-1 of subsection 811.03.B, on page 591 of the Standard Specifications for Construction:

Polyurea	20	Binder (gal)	5.5	8.25	11	17	22	33	44	66
		Bead (lb)	As directed by the manufacturer							
Modified Urethane	20	Binder (gal)	5.5	8.25	11	17	22	33	44	66
		Bead (lb)	As directed by the manufacturer							

Add the following paragraph after the fifth paragraph on page 592 of subsection 811.03.B, of the Standard Specifications for Construction:

Beads are not to be placed in liquid shadow markings.

Add the following subsections after the last paragraph of subsection 811.03.D.7.c, on page 595 of the Standard Specifications for Construction:

- 8. **Modified Urethane.** Ensure the pavement is free of excess surface and subsurface moisture that may affect bonding. The Engineer will not decide the suitability of specific days for the application of modified urethane.

Surface preparation requirements for special, and longitudinal modified urethane pavement markings depend on surface conditions.

Prepare new HMA surfaces and HMA surfaces open to traffic for 10 days or less with no oil drips, residue, debris, or temporary or permanent markings, by cleaning the marking area with compressed air.

Prepare new PCC surfaces and PCC surfaces free of oil drips, residue, and debris, temporary, or permanent markings, by removing the curing compound from the area required for pavement markings.

Prepare existing HMA or PCC surfaces that do not have existing markings, but may have oil drip areas, debris, or both, by scarifying the marking area using non-milling grinding teeth or shot blasting. The Engineer will allow the use of water blasting to scarify the marking area on PCC surfaces.

Prepare existing HMA or PCC surfaces with existing pavement markings and that may have oil drip areas, debris, or both, by using the following methods:

- a. For existing liquid pavement markings, scarify the proposed marking area using non-milling grinding teeth or shot blast. Occasionally existing liquid pavement markings will require complete removal, which will be determined by the Engineer.
- b. For existing cold plastic markings, completely remove the existing markings.

- 9. **Preformed Thermoplastic.** Ensure the pavement is free of excess surface and subsurface moisture that may affect bonding. The Engineer will not decide the suitability of specific days for the application of preformed thermoplastic.

Heat and apply the preformed thermoplastic material as recommended by the manufacturer. Feather all edges of the material with a putty knife while the preformed thermoplastic is still soft.

Modify the following row in Table 811-2 of subsection 811.03.D, on page 596 of the Standard Specifications for Construction to read as follows:

Thermoplastic	50	50	May 1	Nov. 1
---------------	----	----	-------	--------

Add the following rows to Table 811-2 of subsection 811.03.D, on page 596 of the Standard Specifications for Construction:

Modified Urethane	40	40	Apr. 15	Nov. 15
Preformed Thermoplastic	35	35	Apr. 15	Nov. 15

Add the following pay items to the list of pay items in subsection 811.04, on page 598 of the Standard Specifications for Construction:

Pavt Mrkg, Modified Urethane, (symbol).....	Each
Pavt Mrkg, Modified Urethane, (legend)	Each
Pavt Mrkg, Modified Urethane, __ inch, Crosswalk.....	Foot
Pavt Mrkg, Modified Urethane, __ inch, Stop Bar	Foot
Pavt Mrkg, Modified Urethane, __ inch, Cross Hatching, (color).....	Foot
Pavt Mrkg, Modified Urethane, __ inch, (color).....	Foot
Pavt Mrkg, Ovly Cold Plastic, __ inch, Shadow Tape, Black.....	Foot
Pavt Mrkg, Ovly Cold Plastic, __ inch, Wet Reflective, (color)	Foot
Pavt Mrkg, Preformed Thermoplastic, (symbol).....	Each
Pavt Mrkg, Preformed Thermoplastic, (route) Route Shield, __ foot by __ foot.....	Each
Pavt Mrkg, Preformed Thermoplastic, (legend).....	Each
Pavt Mrkg, Preformed Thermoplastic, __ inch, Crosswalk	Each
Pavt Mrkg, Preformed Thermoplastic, __ inch, Stop Bar	Foot
Pavt Mrkg, Preformed Thermoplastic, __ inch, Cross Hatching, (color)	Each
Pavt Mrkg, (binder), __ inch, Shadow Liquid, Black.....	Foot
Pavt Mrkg, Wet Reflective Waterborne, 2nd Application, __ inch, (color).....	Foot

MICHIGAN
DEPARTMENT OF TRANSPORTATION

SPECIAL PROVISION
FOR
WORK ZONE SIGNING ON LOCAL AGENCY PROJECTS

OPR:MWB

1 of 3

APPR:MSBJKG:09-25-06
FHWA:APPR:06-01-11

a. Description. In addition to all other maintaining traffic signs required on this project, place work zone signing in accordance to the MDOT Traffic and Safety *Maintaining Traffic Typical(s)* contained in the proposal, except as modified herein.

On all "Advance Signing Treatment..." *Maintaining Traffic Typical(s)* (M0030 - M0080):

Replace the R5-18b sign "INJURE/KILL A WORKER \$7500 + 15 YEARS" sign with the R5-18bLA "INJURE/KILL A WORKER // FINE - \$ 7500 // JAIL - 15 YRS" sign, as detailed in the attached graphics.

Delete the R5-18 "TRAFFIC FINES DOUBLED IN WORK ZONES" sign or the R5-18a "TO PROTECT HIGHWAY WORKERS FINES DOUBLED IN WORK ZONES" sign, along with the prescribed 'D' spacing distance.

On all other "Typical Temporary Traffic Control..." *Maintaining Traffic Typical(s)* (M0110 et. al.):

Replace the R5-18c "WORK ZONE BEGINS" sign with the R5-18cLA "WORK ZONE BEGINS // TRAFFIC FINES DOUBLED" sign, as detailed in the attached graphics.

Place the G20-1 "ROAD WORK NEXT ___ MILES" sign and the G20-2 "END ROAD WORK" sign in accordance to the appropriate MDOT Traffic and Safety *Maintaining Traffic Typical*.

Place all other work zone signing in accordance to the project plans and specifications, including the appropriate MDOT Traffic and Safety *Maintaining Traffic Typical(s)*. Place all work zone signing in accordance to the standard specifications.

b. Measurement and Payment. Quantities for Local Agency work zone signs will be included in the plan quantities for the pay items **Sign, Type B, Temp, Furn** and **Sign, Type B, Temp, Oper** or **Sign, Type B, Temp, Prismatic, Furn** and **Sign, Type B, Temp, Prismatic, Oper**. Payment for the signs will be made at the contract unit prices.

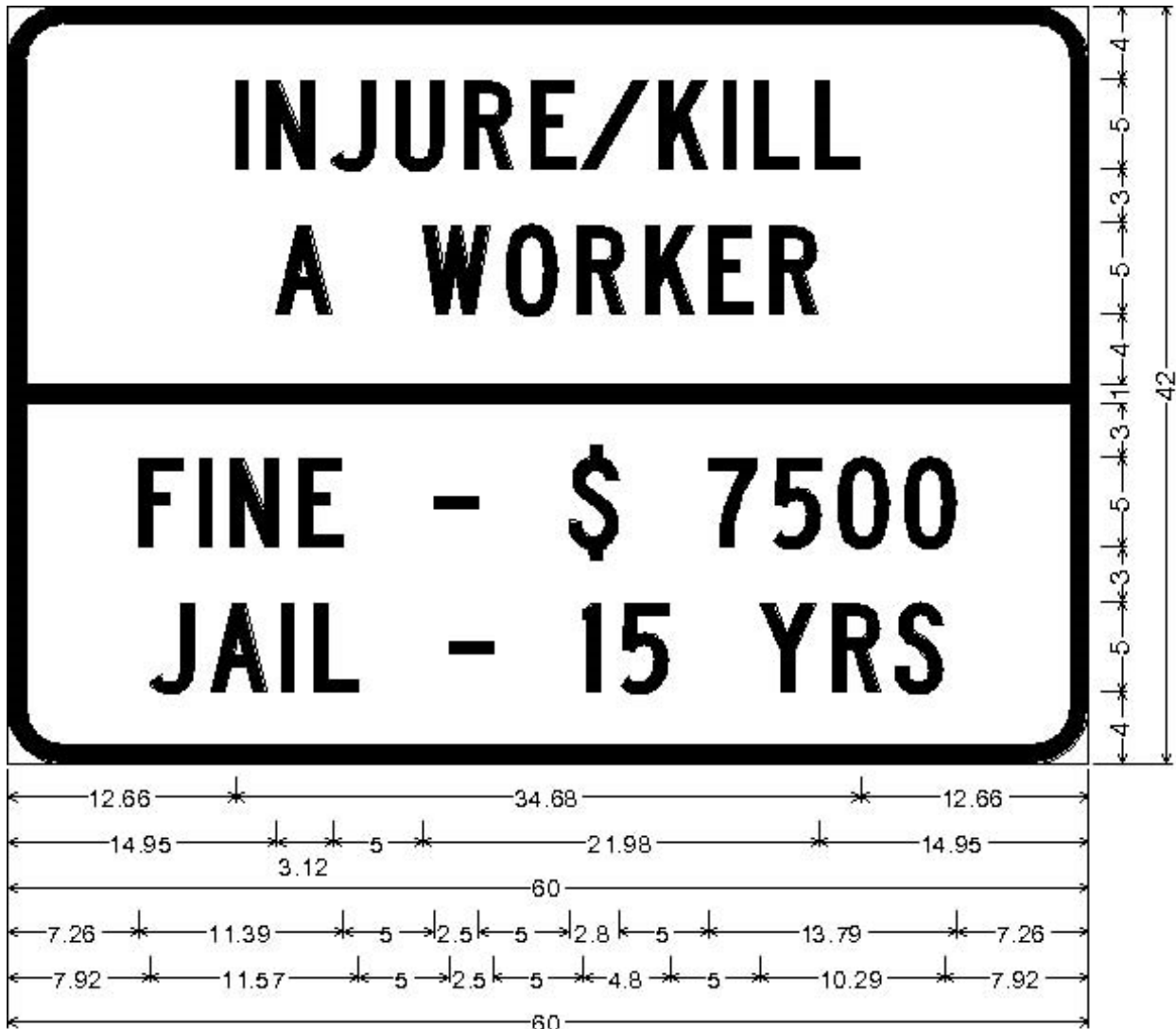

3.00" Radius, 1.00" Border, Black on White;

"INJURE/KILL" C; "A WORKER" C; "FINE - \$ 7500" C; "JAIL - 15 YRS" C;

- All dimensions in inches.
- Not to Scale.

R5-18bLA

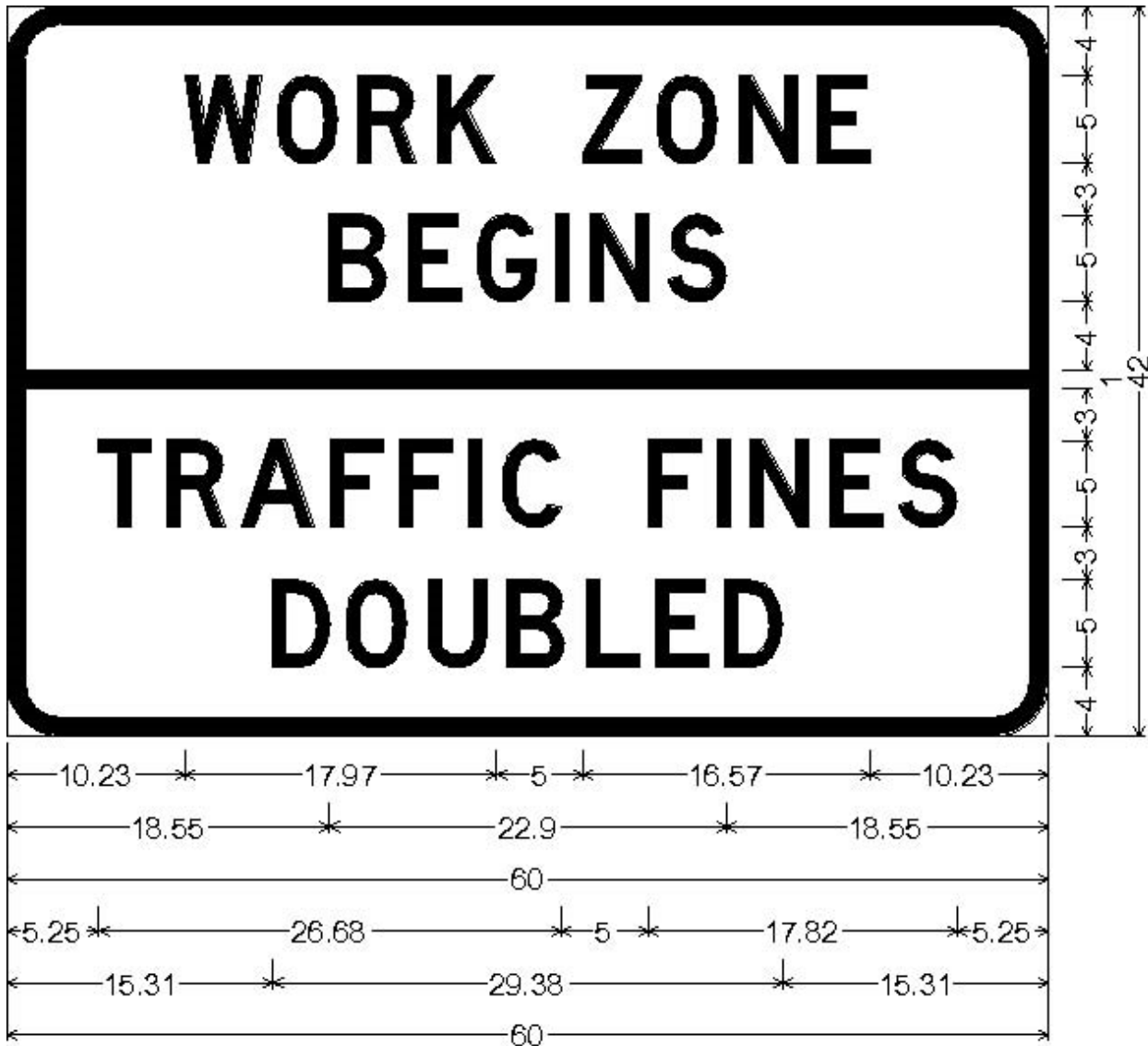

3.00" Radius, 1.00" Border, Black on White;

"WORK ZONE" D; "BEGINS" D; "TRAFFIC FINES" D; "DOUBLED" D;

- All dimensions in inches
- Not to scale

R5-18cLA

MICHIGAN
DEPARTMENT OF TRANSPORTATION

SPECIAL PROVISION
FOR
TRAFFIC CONTROL QUALITY AND COMPLIANCE

OPR:JJG

1 of 2

APPR:CER:DBP:01-20-11
FHWA:APPR:06-20-11

Delete the subsection 812.03.C, Deficient Traffic Control Operations on page 601 of the Standard Specifications for Construction in its entirety, and replace with the following.

C. Deficient Traffic Control Operations.

1. Traffic Control Quality and Compliance. The following applies to all aspects of the traffic control plan and traffic control devices except the Type D lights on plastic drums which are covered elsewhere in the contract.

a. Traffic Control not Anticipated in Design. If at any time during the project, including the time during the seasonal suspension, the Engineer documents that the traffic control requires improvements beyond the scope of the Traffic Control Plan, the Engineer will provide written instructions to the Contractor and traffic control supplier what improvements are required. The Contractor must develop and submit to the Engineer for approval, a written implementation schedule for improvements. If the schedule is not approved, or if the schedule is approved but is not followed, the Department will adjust the contract according to subsection 812.03.C.1.c.iii. If the implementation schedule is not followed, the Engineer will notify the Contractor and traffic control supplier in writing that they are in violation of this subsection. The work of making traffic control improvements directed by the Engineer that are beyond the scope of the Traffic Control Plan will be paid for as extra work.

b. As Designed Traffic Control. If at any time during the project, including the time during the seasonal suspension, the Engineer documents that the traffic control is deficient, inadequate or improperly placed, the Engineer will provide written notification with instructions for corrective action to the Contractor and traffic control supplier. Upon receipt of the notification of corrective action, the Contractor has 4 hours to correct the traffic control. If the traffic control cannot be corrected within the 4 hour time period, the Contractor will develop a written implementation schedule for the corrective action and submit the schedule to the Engineer for approval within 1 hour of receiving the written notification. If the schedule is not approved, or if the schedule is approved but is not followed, the Department will adjust the contract according to subsection 812.03.C.1.c.iii. If the implementation schedule is not followed, the Engineer will notify the Contractor and traffic control supplier in writing that they are in violation of this subsection.

c. Corrective Action. The Engineer will give written notification to the Contractor as identified above. Failure to make corrections within the timeframe required may result in the following actions by the Engineer:

- i. Stop work on the project until the Contractor completes corrective action,
- ii. Order corrective action by others in accordance with subsection 107.07, subsection 108.02, subsection 812.03.B, and in the interest of public safety.
- iii. A contract price adjustment will be made in the amount of \$100 per hour for every hour or portion thereof the improvements or corrective action remains incomplete as described herein. If improvements or corrections have not been made to the satisfaction of the Department, the contract will be adjusted until the traffic control is acceptable.

MICHIGAN
DEPARTMENT OF TRANSPORTATION

SPECIAL PROVISION
FOR
LIGHTING FOR NIGHT WORK SPECIFICATIONS

OPR:RAL

1 of 3

APPR:BMB:MB:02-02-18
FHWA:APPR:02-08-18

Delete subsection 812.03.H, on page 619 of the Standard Specifications for Construction in its entirety and replace it with the following:

H. Lighting for Night Work. Furnish, install, operate, maintain and replace, as needed, fixed, portable, or equipment mounted lighting systems that provide lighting to ensure worker and inspector safety on and around the worksite. Provide lighting that allows workers and inspectors to clearly conduct all operations and inspections during hours of darkness. Provided lighting systems must meet the requirements set forth in *MIOSHA Rule 408.40133 Illumination, MIOSHA Rule 408.42223 (7) Traffic Control*, section 706 of the Standard Specifications for Construction, and the contract.

Provide and position the lamps to meet the following lighting requirements: Provide a minimum illumination intensity of 10 foot-candles (108 lux) on a jobsite where construction work is being performed. Maintain a minimum of 5 foot-candles (54 lux) throughout the entire area of operation where workers may pass through on foot or are present but are not performing construction work. Vehicle or equipment headlights are not considered as an approved light source.

Lighting levels will be measured with an illuminance meter. Readings from smart-phones are not acceptable. Readings will be taken where the work is being performed, in a horizontal plane 3 feet above the pavement or ground surface. When necessary, provide additional lights to overlap the footprints of the lights so that the lighting requirements are continuous, and do not fall below the minimum lighting requirements throughout the work area.

Submit a "work area lighting plan" to the Engineer for review for approval a minimum of 14 calendar days prior to the start of work. The Engineer will have 7 calendar days to review the plan for approval or provide comments for plan revisions required to obtain approval. At a minimum, the plan must include the proposed lighting locations for construction equipment, vehicles and pedestrian paths, identification of a person or persons of authority (including contact information) on the project site responsible to execute the plan requirements, and measures that will be taken to ensure compliance with the plan. All costs and any additional time required to obtain an approved "work area lighting plan" will not be cause for delay or impact claims.

Design and operate the lighting system to avoid glare that interferes with traffic, workers, or inspection personnel. Aim flood, spot or stadium type luminaries downward at the work and rotated outward no greater than 30 degrees from nadir (straight down). Position balloon lights at least 12 feet above the roadway.

Design the lighting system to light the work area without spilling over to adjoining property. Modify the lighting system, if directed by the Engineer, by rearranging the lights or adding hardware to shield the lights when the lighting system is disturbing adjoining properties.

Provide a power source that adequately powers the lamps to their full capacity. Provide all lighting equipment in good operating condition and in accordance with applicable safety and design codes.

Provide backup lighting to replace lights and equipment during nighttime operations. Store the backup equipment on the project site and have it available for use at all times during the nighttime operations. The backup systems must meet the same criteria as the primary system.

Drive through and observe the lighted area from all traveled directions, including cross roads after initial lighting set up to determine the adequacy of placement and potential for glare. Adjust lighting alignment if necessary. Ensure that the alignment of the lighting does not interfere with or impede traffic on open roadways.

At any time during the course of the nighttime work, should the lighting not meet the requirements of this special provision, the work must be halted until adequate lighting is provided. This suspension of work will be at no additional cost to the Department and the Contractor cannot receive an extension of time to complete the work.

Use balloon lighting for nighttime traffic regulating operations. Position the balloon lighting for traffic regulators so that the light illuminates the front of the traffic regulator without casting a shadow on the front of the regulator, the light or equipment does not impair the regulator's vision, and the equipment does not impede the regulator's escape path. Position the lighting so that the light does not wash out the lighted arrow at the regulator's station and does not obscure the lighted arrow. Position lighting so that it does not create glare or shine directly in the eyes of oncoming drivers. Illuminate the traffic regulator's station with a minimum illumination intensity of 10 foot-candles (108 lux). Lighting devices used to illuminate nighttime traffic regulator operation that have failed or have been damaged are to be replaced immediately.

Mount the light fixtures on the construction equipment in a mobile operation, in such a way that the view of the equipment operator is not obstructed and a secure connection to the equipment is ensured, with minimum vibration.

Provide each paver with the minimum illumination as specified in this special provision so that the operator and paving crew can clearly see the material going into the hopper, the auger area, and for alignment. Provide a continuous power source to ensure the lighting is in operation at all times during work. The light should be adjustable up and down, and rotatable horizontally. The area behind the paver must be lighted so the work and operations can be seen clearly and inspected properly.

Equip each roller with four headlights, two facing in each direction of travel. Turn headlights off when facing oncoming traffic and only use them when moving equipment from one location to another.

Provide a continuous power source on each roller with a light tower. The light tower must be a minimum of 4 feet higher than the roller.

When light equipment is not in use, it must be removed from the work area.

MICHIGAN
DEPARTMENT OF TRANSPORTATION

SPECIAL PROVISION
FOR
LIGHTING FOR NIGHT WORK

OPR:RAL

1 of 1

APPR:BMB:MB:02-02-18
FHWA:APPR:03-01-18

Delete subsection 812.04.T, on page 631 of the Standard Specifications for Construction in its entirety and replace it with the following:

T. **Ltg for Night Work.** The unit price for Ltg for Night Work includes submittal of a work area lighting plan and furnishing, installing, relocating, replacing, and maintaining lighting for the entire project. There will be no adjustments in the lump sum price regardless of the number or type of lighting systems or if stand by units are required to complete all night work on the project as described in subsection 812.03.H and as directed by the Engineer.

MICHIGAN
DEPARTMENT OF TRANSPORTATION

SPECIAL PROVISION
FOR
PRICE ADJUSTMENTS FOR AUTHORIZED EXTENSIONS OF TIME

CFS:MB

1 of 2

APPR:JYG:CRB:02-01-18
FHWA:APPR:02-02-18

Delete section 812.04.U, Price Adjustments for Authorized Extensions of Time, on page 631 and 632 of the Standard Specifications for Construction in its entirety and replace with the following.

U. Price Adjustments for Authorized Extensions of Time. The Department will not adjust the unit price for **TS, Temp, Furn** for authorized extensions of time.

The Department will not make price adjustments for temporary traffic control devices, **Minor Traf Devices**, and **Traf Regulator Control** during authorized extensions of time if liquidated damages are assessed in accordance with subsection 108.10. If liquidated damages are not assessed, the Department will adjust unit prices for the following:

1. **TS, Temp, Oper;**
2. **PTS System, Temp, Oper;**
3. Items designated as Furnished, Operated, or Standby, unless otherwise specified;
4. Items paid for as Each or Foot as documented by the Department and maintained on the Department website at:
http://www.michigan.gov/mdot/0,4616,7-151-9622_11044_11367---,00.html; and
5. Items measured as lump sum if they are used or required on the worksite during authorized extensions of time except that **Minor Traf Devices** will not be adjusted when conspicuity tape is the only minor traffic control device in service or required during the authorized extension of time.
6. Items not in use reserved by the Engineer as standby.

The Department will use the following formula to calculate the unit price adjustments. The adjustment for **Minor Traf Devices** will be at a daily rate of (A/B) not to exceed \$900.00 per calendar or work day and the adjustment for **Traf Regulator Control** will be at a daily rate of (A/B) not to exceed \$650.00 per calendar or work day. When calculating the adjustment, either calendar or working days will be used for both original contract time and additional days.

$(A/B) \times C = \text{unit price adjustment}$

Formula 812-1

where:

A = Original contract unit price

B = Original contract time

C = Additional days the item was in use or required to be on standby during the authorized extension of time.

The Department will determine the number of additional days the item is on standby or in use in calendar days.

For calendar date projects, the original contract time will be calculated as the number of calendar days from the actual start date to the following order of precedence date as identified within the contract:

- a. The latest Open to Traffic date if removal of all traffic control devices coincides with this date.
- b. The latest interim completion date for each season of work if all contract work must be completed in its entirety except turf establishment and watering and cultivating.
- c. The original contract completion date.

For work day projects if an authorized extension of time extends into the next construction season, including seasonal suspension periods during which a traffic control item is on standby or in use, the original contract time will be the calendar days between the first work day and the expiration of the original contract completion.

MICHIGAN
DEPARTMENT OF TRANSPORTATION

SPECIAL PROVISION
FOR
PAYMENT FOR MINOR TRAFFIC DEVICES AND TRAFFIC REGULATOR CONTROL

OPR:JJG

1 of 1

APPR:BJO:DBP:07-19-11
FHWA:APPR:07-19-11

Delete Table 812-1 in subsection 812.04.E, on page 625 of the Standard Specifications for Construction, in its entirety and replace with the following.

Table 812-1 Partial Payment Schedule for Minor Traf Devices and Traffic Regulator Control

Percent of Original Contract Amount Earned	Total Percent of Unit Price Paid
First Use	15
25	30
50	55
75	80
90	100

MICHIGAN
DEPARTMENT OF TRANSPORTATION

SPECIAL PROVISION
FOR
SIGN, TYPE B, TEMPORARY, PRISMATIC, SPECIAL

COS:CRB

1 of 2

APPR:MWB:CGB:04-29-19
FHWA:APPR:05-07-19

a. Description. This work consists of fabricating, placing, maintaining, removing, and/or relocating the Type B, Temporary, Prismatic, Special signs identified in the proposal or on the plans. The signs have non-standard legends and may be project specific.

b. Materials. Use prismatic grade reflective sheeting, as described in section 922 of the Standard Specifications for Construction.

Ensure all temporary signs meet the specifications in subsection 812.03.D.1 of the Standard Specifications for Construction and be approved by the Engineer prior to use.

Route markers or overlays used in the fabrication or modification of Type B, Temporary, Prismatic, Special signs must either be directly applied to the Type B, Temporary, Prismatic, Special sign face or be fabricated utilizing Type III or Type IV substrate as defined in section 919 of the Standard Specifications for Construction. Overlays or route markers fabricated with Type II substrates are prohibited.

c. Construction. The Type B, Temporary, Prismatic, Special signs must meet the requirements for Sign, Type B, Temp, Prismatic, Furn and Sign, Type B, Temp, Prismatic, Oper as outlined in section 812 of the Standard Specifications for Construction.

Ensure Type B, Temporary, Prismatic, Special signs are not fabricated with vertical seams. Horizontal seams are not to cross through the sign legend.

Temporary Type IV substrate sign overlays may be used to modify the legends of Type B, Temporary, Prismatic, Special signs.

Install Type B, Temporary, Prismatic, Special signs on driven sign supports, in accordance with subsections 812.03, 919.04 and section 912 of the Standard Specifications for Construction, unless otherwise indicated on the plans, in the proposal or approved by the Engineer.

d. Measurement and Payment. The completed work, as described, will be measured and paid for at the contract unit price using the following pay items:

Pay Item	Pay Unit
Sign, Type B, Temp, Prismatic, Spec, Furn	Square Foot
Sign, Type B, Temp, Prismatic, Spec, Oper	Square Foot

1. **Sign, Type B, Temp, Prismatic, Spec, Furn** will be paid for the same as described for the pay item Sign, Type __, Temp, Prismatic, Furn in subsection 812.04.C of the Standard

Specifications for Construction. In addition, the pay item includes the fabrication of all initial route markers and overlays for the Type B, Temporary, Prismatic, Special signs.

2. **Sign, Type B, Temp, Prismatic, Spec, Oper** will be paid for the same as described for the pay item Sign, Type __, Temp, Prismatic, Oper in subsections 812.04.D and 812.04.B of the Standard Specifications for Construction.

Payment for operated items also includes the removal of all portable or driven sign supports (including post stubs and ballast) used to install the Type B, Temporary, Prismatic, Special signs.

Payment for operated items will also include the installation and/or removal of all overlays used to modify portions of Type B, Temporary, Prismatic, Special signs as specified on the plans, in the proposal or required by the Engineer and includes all equipment and material necessary to install and/or remove the overlays as required for the life of the contract. When sign overlays, including different route markers, are used to modify portions of Type B, Temporary, Prismatic, Special signs, only the overlay will be paid for as additional square footage of **Sign, Type B, Temp, Prismatic, Spec, Furn.**

MICHIGAN
DEPARTMENT OF TRANSPORTATION

SPECIAL PROVISION
FOR
DELINEATION OF PORTABLE CHANGEABLE MESSAGE SIGN

OFS:RAL

1 of 1

APPR:CRB:MB:05-01-18
FHWA:APPR:05-02-18

Delete subsection 812.03.D.15, on page 614 of the 2012 Standard Specifications for Construction, in its entirety and replace with the following:

15. **Portable Changeable Message Signs.** Use portable changeable message signs (PCMS) as required. Delineate the PCMS with three plastic drums or three 42 inch channelizing devices. If the PCMS is in use, rest the tires on the ground with wheel chocks or elevate the trailer, with the bottom of the tires above the ground. If a PCMS is not needed, turn it off and remove it from the clear zone in accordance with subsection 812.03.G.5.

The Department will allow use of PCMS for either advance time notification for future events including closures and planned maintenance work or information including detours or alternative routes during current events; incident management; construction zone backups; or similar conditions.

Do not use generic, non-emergency safety messages. If power to the PCMS is lost, use four corner flash mode (an asterisk in each corner of the board, flashing) as the default setting. Ensure message sequences consist of no greater than two messages with a 2-second display time for each message.

Do not use PCMS for the following:

- a. Replacing MMUTCD required static signing or pavement markings;
- b. Replacing a lighted arrow;
- c. Advance notice of new traffic signals or signs; or
- d. Advertising.

MICHIGAN
DEPARTMENT OF TRANSPORTATION

SPECIAL PROVISION
FOR
SUPPORTS FOR TEMPORARY SIGNS

OPR:CRB

1 of 1

APPR:MWB:DBP:06-26-12
FHWA:APPR:08-18-12

Delete the last paragraph of subsection 812.03.D.3, on page 604 of the Standard Specifications for Construction in its entirety, and replace with the following.

Mount construction signs on portable sign support standards only if signs are to remain in place for 14 days or less, or as allowed by the Engineer if fixed supports are not possible.

MICHIGAN
DEPARTMENT OF TRANSPORTATION

SPECIAL PROVISION
FOR
SECURITY OF PORTABLE CHANGEABLE MESSAGE SIGNS

OFS:CRB

1 of 1

APPR:LWB:DBP:10-09-13
FHWA:APPR:10-09-13

a. Description. This work consists of making certain the portable changeable message sign (PCMS) is secure, and complies with the following:

1. Create unique usernames and passwords (not defaults) for access to the PCMS local controls.
2. Remove all literature (manuals, instructions, etc.) from the PCMS controller enclosure.
3. Use a padlock, keyed lock, etc to prevent access to the controller enclosure.
4. Provide the Engineer up to 3 keys, or the lock combination, as well as the usernames and passwords.
5. Provide at minimum, one classroom style training session of 2 hours, on PCMS field equipment, including but not limited to: posting and removal of messages, diagnosing field equipment malfunctions including messaging and communications errors. All training schedules, syllabus and materials are to be supplied by the Contractor and approved by the Engineer prior to delivery of training. Unless otherwise specified by the Engineer, the number of participants at each training session will be limited to a maximum of 20 individuals

MDOT reserves the right to take full messaging control of any PCMS at any time throughout the duration of the project. This includes posting any message determined to be appropriate by MDOT

MDOT may, at any time, inspect PCMS boards that are on site to verify that the security measures in this special provision are being followed.

MICHIGAN
DEPARTMENT OF TRANSPORTATION

SPECIAL PROVISION
FOR
MEASUREMENT AND PAYMENT OF TEMPORARY TRAFFIC CONTROL DEVICES

OFS:CRB

1 of 1

APPR:MWB:JJG:02-27-14

FHWA:APPR:03-04-14

Delete subsection 812.04.A.4, on page 624 of the Standard Specifications for Construction in its entirety.

Delete the second paragraph of subsection 812.04.C, on page 624 of the Standard Specifications for Construction in its entirety, and replace with the following:

The Engineer will measure **Sign, Type __, Temp, Prismatic, Furn** as the total cumulative area of the maximum number of each sign legend that is in use during the course of the project unless previously paid. The unit price for **Sign, Type __, Temp, Prismatic, Furn** includes the cost of portable or driven sign supports.

Delete the second paragraph of subsection 812.04.D, on page 624 of the Standard Specifications for Construction in its entirety, and replace with the following:

The Engineer will measure **Sign, Type __, Temp, Prismatic, Oper** as the total cumulative area of the maximum number of each sign legend that is in use during the course of the project unless previously paid.

MICHIGAN
DEPARTMENT OF TRANSPORTATION

SPECIAL PROVISION
FOR
TYPE III BARRICADES

DES:DBP

1 of 1

APPR:MWB:CRB:08-07-15
FHWA:APPR:08-23-15

Delete the first sentence for the second paragraph in subsection 812.03.D.8 on page 606 of the Standard Specifications for Construction, and replace with the following:

Light Type III barricades with two, Type C or Type D warning lights, fastened to the uprights above the top rail, provided these warning lights each weigh 3.3 pounds or less.

Delete the following pay items from the list in subsection 812.04 on page 622 of the Standard Specifications for Construction.

Barricade, Type III, High Intensity, Furn.....	Each
Barricade, Type III, High Intensity, Oper	Each
Barricade, Type III, High Intensity, Double Sided, Furn	Each
Barricade, Type III, High Intensity, Double Sided, Oper	Each

Renumber the existing subsection 812.04.A.5 on page 624 of the Standard Specifications for Construction, as follows:

4. The manufacturer's invoiced cost for damaged equipment included in a lump sum pay item for maintaining traffic.

MICHIGAN
DEPARTMENT OF TRANSPORTATION

SPECIAL PROVISION
FOR
TEMPORARY PAVEMENT MARKING REVISIONS

COS:CGB

1 of 4

APPR:MWB:MKB:06-14-19
FHWA:APPR:06-26-19

Delete subsection 812.03.D.11.a, on page 610 of the Standard Specifications for Construction, in its entirety and replace with the following:

- a. **Temporary Pavement Marking - Wet Reflective Type R.** Use temporary wet reflective pavement marking Type R (removable tape) when temporary pavement markings must be placed on finished pavements and are not in the exact location as future permanent markings or at the discretion of the Engineer when temporary markings must be removed during the life of a project.

Ensure prior to installation the pavement surface is air blown or brushed to remove surface dust and dirt. Remove curing compound from new concrete surfaces before applying Type R Tape.

Place wet reflective Type R tape when it is used as a 4-foot dash or full-length skip line as defined in the contract to temporarily mark finished pavement prior to the placement of permanent markings in accordance with the manufacturer's specifications for existing temperature and pavement condition. Offset the dash or skip lines 1 foot from the permanent marking so that the permanent markings can be placed prior to the removal of the 4-foot dashes or full-length skip lines. Do not use 4-foot dashes or full-length skip lines to temporarily mark a solid edge line. Ensure damaged or missing tape of more than 2 consecutive skip lines is replaced within 24 hours after notification by the Engineer. Failure to replace the tape within the 24-hour time period may result in a contract price adjustment as described in 12SP-812C - Traffic Control Quality and Compliance.

- i. Between April 15 and November 1, place wet reflective Type R tape not used as a skip line in accordance with the manufacturer's specifications for existing temperature and pavement condition. Replace wet reflective Type R tape of more than 50 cumulative feet that fails within 24 hours after notification by the Engineer. Failure to replace the tape within the 24-hour time period may result in a contract price adjustment as described in 12SP-812C - Traffic Control Quality and Compliance.
- ii. From November 2 to December 1 and March 15 to April 14, place wet reflective Type R tape for all temporary shifts and tapers when pavement surfaces are dry and air temperatures are 40 degrees Fahrenheit (F) and rising. Ensure all wet reflective Type R tape placed during these times is placed during approved daytime hours negotiated between the Engineer and the Contractor or daytime hours required in the contract.

Do not place wet reflective Type R tape within 24 hours of predicted precipitation, or 24 hours after any precipitation. The Contractor will be paid to repair locations that fail during these times unless the Engineer determines the failure is due to improper

- surface preparation, or failure to follow these requirements. Repairs, if required, will be paid for at a negotiated price between the Engineer and the Contractor for the associated work.
- iii. Use temporary wet reflective pavement marking Type NR paint, for all tapers and shifts when ambient air temperature is less than 40 degrees F. To remove the wet reflective Type NR paint, use the least abrasive technique as directed by the Engineer to minimize scarring. If the approved pavement marking removal pay item is not part of the contract, the cost of the removal of Type NR pavement markings will be negotiated between the Engineer and the Contractor.
 - iv. Wet reflective Type R tape is not to be placed between December 2 and March 14.

Delete subsection 812.03.D.11.b, on page 610 of the Standard Specifications for Construction, in its entirety and replace with the following:

b. Temporary Pavement Marking - Wet Reflective Type NR.

- i. **Wet Reflective Type NR Paint.** Use temporary pavement marking Wet Reflective Type NR paint when temporary pavement markings must be placed on pavement to be removed or replaced during construction. It also must be used when temporary markings line up exactly with the placement of permanent markings and may be grooved out prior to recessing permanent markings. The temporary pavement marking material must be compatible with the material specified for the permanent markings if permanent markings are to be placed on top of temporary markings.

Place Wet Reflective Type NR paint in accordance with section 811. Place the material binder at a thickness of 18 mils while driving at a maximum rate of 8 miles per hour. Drop wet reflective optics and glass beads at a rate as recommended by the manufacturer for an approved wet reflective system. Ensure the proposed wet reflective optic is approved by the Engineer.

Place Wet Reflective Type NR paint, used as a 4-foot dash or full-length skip line as defined in the contract, to temporarily mark finished pavement prior to the placement of permanent markings, in the exact location as the permanent marking such that its removal is not necessary. Only use Wet Reflective Type NR markings compatible with the permanent pavement marking material specified on the project as a 4-foot dash or full-length skip line. Do not use 4-foot dashes or full-length skip lines to temporarily mark a solid edge line.

- ii. **Wet Reflective Type NR Tape.** Use temporary pavement marking Wet Reflective Type NR Tape as a 4-foot dash or full-length skip line as defined in the contract to temporarily mark a white skip line or yellow centerline on base or leveling course pavement. Wet Reflective Type NR tape must not be used to temporarily mark a solid edge line. Wet Reflective Type NR tape is not to be used on the wearing course of asphalt or on existing pavement. Place Wet Reflective Type NR tape in accordance with section 811.

Delete the following pay items from the list of pay items in subsection 812.04, on page 623

of the Standard Specifications for Construction:

- Pavt Mrkg, Type R, 4 inch, (color), TempFoot
- Pavt Mrkg, Type NR, Tape, 4 inch, (color), Temp.....Foot
- Pavt Mrkg, Type NR, Paint, 4 inch, (color), Temp.....Foot

Add the following pay items to the list of pay items in subsection 812.04, on page 623 of the Standard Specifications for Construction:

- Pavt Mrkg, Wet Reflective, Type R, Tape, 4 inch, (color), TempFoot
- Pavt Mrkg, Wet Reflective, Type NR, Paint, 4 inch, (color), TempFoot
- Pavt Mrkg, Wet Reflective, Type NR, Tape, 4 inch, (color), TempFoot
- Pavt Mrkg, Wet Reflective, Type R, Tape, 8 inch, (color), TempFoot
- Pavt Mrkg, Wet Reflective, Type NR, Paint, 8 inch, (color), TempFoot
- Pavt Mrkg, Wet Reflective, Type NR, Tape, 8 inch, (color), TempFoot

Delete subsection 812.04.N.2, on page 629 of the Standard Specifications for Construction, in its entirety and replace with the following:

- 2. **Non-Removable (Type NR) Pavement Markings.** The unit price for the relevant **Pavt Mrkg, Wet Reflective, Type NR, Paint, Temp** and **Pavt Mrkg, Wet Reflective, Type NR, Tape, Temp** pay items include the cost of providing and placing temporary pavement markings.

Delete subsection 812.04.N.3, on page 629 of the Standard Specifications for Construction, in its entirety and replace with the following:

- 3. **Removable (Type R) Pavement Markings.** The unit prices for **Pavt Mrkg, Wet Reflective, Type R, Tape, 4 inch, (color), Temp** and **Pavt Mrkg Cover, Type R, (color)** include the cost of providing, placing, maintaining, removing and disposing of temporary pavement marking. Payment will be per foot measured along the length of the placed pavement marking.

Delete subsection 922.06.A.1 on page 937 of the Standard Specifications for Construction in its entirety and replace with the following:

- 1. **Pavement Marking, Wet Reflective, Type R.** Provide wet reflective Type R temporary pavement marking as preformed tape. Select wet reflective Type R markings from the Qualified Products List (922.06A). Apply and remove preformed tape in accordance with the manufacturer's instructions. The tape must remain flexible and conform to the texture of the pavement surface during use.

Delete subsection 922.06.A.2, on page 937 of the Standard Specifications for Construction, in its entirety and replace with the following:

- 2. **Pavement Marking, Wet Reflective, Type NR Paint.** Provide Wet Reflective Type NR

temporary pavement markings as paint reflectorized with a wet reflective optic system recommended by the manufacturer and as approved by the Engineer, as required.

- a. **Wet Night Retro Reflective Optics.** Select wet reflective optics from the Qualified Products List (920.02C) or an alternative that exceeds the requirements in Table 922-2 as approved by the Engineer:

Table 922-2 Temporary Wet Reflective Type NR Pavement Markings		
Average Initial Retro reflectivity at 30-meter geometry in mcd/lux/sq m with flow of placement		
Test Method	Color	
	White	Yellow
Dry (<i>ASTM E 1710</i>)	700	500
Wet Recovery (<i>ASTM E 2177</i>)	250	200

Ship the material to the job site or Contractor’s yard in sturdy containers marked in accordance with subsection 920.01.A of the Standard Specifications for Construction.

Select glass beads for corresponding materials in accordance to subsection 920.02 of the Standard Specifications for Construction.

Submit to the Engineer prior to the start of work a general certification from the manufacturer that when applied in accordance with the construction methods herein, the glass beads and wet reflective optics will meet the minimum requirements shown in Table 922-2.

- b. **Binder Material for Temporary Wet Reflective Type NR Pavement Markings.** Select the liquid applied pavement marking from one of the materials from the following Qualified Products Lists to use as a binder for the wet reflective optics or use an alternative as approved by the Engineer:

- 811.03D1 Waterborne, Liquid Pavement Marking Material
- 811.03D2 Low Temperature Waterborne, Liquid Pavement Marking Material
- 811.03D3 Regular Dry Paint, Liquid Pavement Marking Material

- 3. **Pavement Marking, Wet Reflective, Type NR Tape.** Provide Wet Reflective Type NR temporary pavement markings as preformed tape. The tape must remain flexible and conform to the texture of the pavement surface during use. Select wet reflective Type NR tape from the Qualified Products List (922.06A).

MICHIGAN
DEPARTMENT OF TRANSPORTATION

SPECIAL PROVISION
FOR
PAYMENT OF TEMPORARY TRAFFIC CONTROL DEVICES

OFS:CRB

1 of 1

APPR:CGB:MB:08-26-16
FHWA:APPR:09-13-16

Delete subsection 812.04.A Damage Compensation, on page 623 of the Standard Specifications for Construction, in its entirety and replace with the following:

A. Damage Compensation. Notify the Engineer of damaged temporary traffic control devices. Before replacement and disposal, allow the Engineer to verify the condition of damaged temporary traffic control devices eligible for payment. Damage will be assumed to have occurred from vehicular traffic unless otherwise documented. The Department will pay as follows, for replacing temporary traffic control devices or equipment that are placed appropriately and damaged by vehicular traffic, other than the Contractor's vehicles and equipment.. Devices will be assumed to be placed appropriately unless otherwise documented. Replacement will be made up to project completion (excluding water and cultivating), as follows:

1. The **Furnished** unit price for temporary traffic control devices paid for as furnished pay items, excluding Plastic Drums and 42 inch channelizing devices;
2. The unit price for devices not paid for as **Furnished**;
 - a. Plastic Drums and 42 inch Channelizing Devices will be paid for at a set rate of \$35 per Plastic Drum and \$18 per damaged 42 inch Channelizer.
 - i. Prior to payment the Plastic Drum or 42 inch Channeling Device must be classified as unacceptable, per the ATSSA Quality Guidelines for Temporary Traffic Control Devices and Features (ATSSA QG), and spray-painted with an X.
 - ii. All Plastic Drums and 42 inch Channelizing Devices that are classified as marginal, per the ATSSA QG, during the project, will have blue survey ribbon tied to the handle. MDOT will be responsible for marking marginal devices. Removal and replacement will take place as defined under the Quality Classifications and Requirements Section of the ATSSA QG and will be at no additional cost to the Department.
 - If at any time, any Contactor, is witnessed tampering with the marginal marking method, the Engineer may require all marginal devices on the project to be upgraded to acceptable outside the timeframes detailed in the ATSSA QG.
3. The manufacturer's invoice cost for devices required by the Engineer and not included in the unit price for other relevant pay items;
4. The manufacturer's invoiced cost for damaged equipment included in a lump sum pay item for maintaining traffic.

MICHIGAN
DEPARTMENT OF TRANSPORTATION

SPECIAL PROVISION
FOR
**TEMPORARY SPECIAL PAVEMENT MARKINGS (TRANSVERSE, LEGEND, AND
SYMBOL)**

OFS:CGB

1 of 2

APPR:MB:CRB:04-10-17

FHWA:APPR:04-24-17

a. Description. This work consists of furnishing, installing, and disposing of temporary transverse, legend, and symbol special pavement markings in accordance with the contract and as directed by the Engineer. Where temporary special pavement markings are required in this contract, use Type R temporary wet reflective special markings if the markings applied during the project require removal during the life of the contract. Use Type NR temporary special markings if the markings applied during the project can remain in place or are located on pavement to be removed or replaced during construction, or if the manufacturer temperature requirements for temporary tape cannot be met.

b. Materials.

1. Temporary Special Markings - Wet Reflective, Type R, Tape. Provide Type R temporary special markings from the Qualified Products List (subsection 922.06.A of the Standard Specifications for Construction). Apply and remove tape in accordance with the manufacturer's instructions. The tape must remain flexible and conform to the texture of the pavement surface during use. All curved arrows, curved legends, and curved symbols must be precut or fabricated prior to being placed in the field.

2. Temporary Special Markings - Type NR, Paint. Provide Type NR temporary special markings as paint reflectorized with glass beads, from the Qualified Products List (subsection 922.06.A of the Standard Specifications for Construction).

c. Construction. Install the temporary pavement markings in accordance with Pavement Marking Special Detail PAVE-900 Series.

1. Temporary Special Markings - Wet Reflective, Type R, Tape. Between April 15 and November 1, place Type R wet reflective tape in accordance with the manufacturer's specifications for existing temperature and pavement conditions.

Utilizing 4 or 6 inch lines to create a symbol or stop bar is prohibited. Ensure the symbol is fabricated prior to being placed in the field and the stop bar is made out of 12 inch material.

Replace Type R wet reflective tape that fails, as directed by the Engineer. Special markings that fail due to improper installation per the manufacturer's specifications will not be paid for. The Engineer will document the failure and meet with the Contractor and/or supplier to discuss reason for failure. Payment will be as determined by the Engineer. Otherwise marking failure will be assumed to be damaged by traffic unless documented in the Inspector's Daily Report (IDR). Marking failure due to traffic or not clearly documented in an IDR, will be paid for at the contract unit price.

2. Temporary Special Markings - Type NR. Place Type NR markings in accordance with section 811 of the Standard Specifications for Construction. Use pavement marking Type NR temporary special markings when temporary pavement markings must be placed between November 2 and April 14, or if the removal of the temporary marking will occur after December 1.

Special markings that fail due to improper installation per the manufacturer’s specifications will not be paid for. The Engineer will document the failure and meet with the Contractor and/or supplier to discuss reason for failure. Payment will be as determined by the Engineer. Otherwise marking failure will be assumed to be damaged by traffic unless documented in the Inspector’s Daily Report (IDR). Marking failure due to traffic or not clearly documented in an IDR, will be paid for at the contract unit price.

d. Measurement and Payment. The completed work, as described, will be measured and paid for at the contract unit price using the following pay items:

Pay Item	Pay Unit
Pavt Mrkg, Wet Reflective, Type R, Tape, __ inch, Crosswalk	Foot
Pavt Mrkg, Wet Reflective, Type R, Tape, 12 inch, Cross Hatching, (color).....	Foot
Pavt Mrkg, Wet Reflective, Type R, Tape, __ inch, Stop Bar	Foot
Pavt Mrkg, Wet Reflective, Type R, Tape, (legend)	Each
Pavt Mrkg, Wet Reflective, Type R, Tape, (symbol).....	Each
Pavt Mrkg, Type NR, Paint, __ inch, Crosswalk.....	Foot
Pavt Mrkg, Type NR, Paint, 12 inch, Cross Hatching, (color).....	Foot
Pavt Mrkg, Type NR, Paint, __ inch, Stop Bar	Foot
Pavt Mrkg, Type NR, Paint, (legend)	Each
Pavt Mrkg, Type NR, Paint, (symbol).....	Each

1. **Pavt Mrkg, Wet Reflective, Type R, Tape, __ inch, Crosswalk; Pavt Mrkg, Wet Reflective, Type R, Tape, 12 inch, Cross Hatching, (color); Pavt Mrkg, Wet Reflective, Type R, Tape, __ inch, Stop Bar; Pavt Mrkg, Wet Reflective, Type R, Tape, (legend); and Pavt Mrkg, Wet Reflective, Type R, Tape, (symbol)** include all materials, labor, and equipment necessary to provide, place, maintain (as noted), remove, and properly dispose of temporary pavement markings.

2. **Pavt Mrkg, Type NR, Paint, __ inch, Crosswalk; Pavt Mrkg, Type NR, Paint, 12 inch, Cross Hatching, (color); Pavt Mrkg, Type NR, Paint, __ inch, Stop Bar; Pavt Mrkg, Type NR, Paint, (legend); and Pavt Mrkg, Type NR, Paint, (symbol)** include all materials, labor, and equipment necessary to provide and place temporary pavement markings. Removal will be paid for separately under the respective pay items.

MICHIGAN
DEPARTMENT OF TRANSPORTATION

SPECIAL PROVISION
FOR
USE OF 42-INCH CHANNELIZING DEVICES

OFS:RAL

1 of 1

APPR:CRB:MB:06-30-17
FHWA:APPR:07-21-17

Delete subsection 812.03.D.6, on page 605 of the Standard Specifications in its entirety and replace it with the following:

6. **42-inch Channelizing Devices.** Provide and install 42-inch tall, retro-reflective plastic channelizing devices as shown on the plans, or directed by the Engineer. Do not attach lights.
- a. **Daytime Use.** The Department will allow the daytime use of 42-inch channelizing devices in tapers and tangents for the following:
- i. Capital Preventative Maintenance (CPM) projects, pavement marking, chip seal, microsurface, and crack-filling projects;
 - ii. Any projects where the use of plastic drums restricts proposed lane widths to less than 11 feet, including shy distance; or
 - iii. Work durations of 12 hours or less.

The devices must be placed such that spacing does not exceed the maximum values described in Table 812-1:

Table 812-1 Maximum Spacing for 42-inch Channelizing Devices		
Work Zone Speed Limit	Taper	Tangent
< 45 mph	1.0 S	2.0 S
≥ 45 mph	50 feet	100 feet
S=Work Zone Speed Limit (mph)		

- b. **Nighttime Use.** The Department will allow the nighttime use of 42-inch channelizing devices in tangents and tapers for the following:
- i. Capital Preventative Maintenance (CPM) projects, pavement marking, chip seal, microsurface, and crack-filling projects;
 - ii. Any projects where the use of plastic drums restricts proposed lane widths to less than 11 feet, including shy distance; or
 - iii. Work durations of 12 hours or less.

Place the devices a maximum distance of 50 feet apart in tangent sections, and a maximum of 25 feet apart in tapers. These spacing requirements apply for all speed limits.

MICHIGAN
DEPARTMENT OF TRANSPORTATION

SPECIAL PROVISION
FOR
FLUORESCENT PLASTIC DRUM

OFS:RAL

1 of 2

APPR:CRB:MWB:06-21-17
FHWA:APPR:07-21-17

a. Description. This work consists of furnishing, installing, maintaining, relocating, and removing a fluorescent plastic drum as identified in the contract.

b. Materials. Provide a fluorescent plastic drum that is crashworthy in accordance with the *National Cooperative Highway Research Program Report 350 (NCHRP 350)* or *Manual for Assessing Safety Hardware (MASH)*, in addition to meeting the following requirements:

1. Provide a plastic drum and ballast in accordance with the standard specifications.

2. Equip the drum with reflective sheeting that meets the requirements of *ASTM D 4956* for reboundable Type IV Fluorescent Orange, and reboundable Type IV White. This sheeting must also meet the dimensional and installation requirements of Special Detail WZD-125. The florescent orange sheeting must have a Daytime Luminance factor that meets or exceeds 20 based on *Table 2 of ASTM D 4956 - Daytime Luminance Factor (Y%)^A*. The white sheeting must have a Daytime Luminance factor that meets or exceeds 27 based on *Table 2 of ASTM D 4956 - Daytime Luminance Factor (Y%)^A*.

A. Use sheeting from one of the following manufacturers or an approved equal:

(1) WR-7100 (white) and WR-7114(fluorescent orange), manufactured by Avery Dennison - Reflective Solutions, 7542 N. Natchez Ave. Nilis, IL, 60714, (877)-214-0909.

(2) 3910 (white) and 3914 (fluorescent orange) Diamond Grade Flexible Work Zone Sheeting, manufactured by 3M Traffic Safety & Security Division, 3M Center, 225-4N-14 St. Paul, MN, 55144, (800)-553-1380.

c. Construction. Install the fluorescent plastic drums at locations specified in the contract or as directed by the Engineer.

d. Measurement and Payment. The completed work, as described, will be measured and paid for at the contract unit price using the following pay items:

Pay Item	Pay Unit
Plastic Drum, Fluorescent, Furn	Each
Plastic Drum, Fluorescent, Oper.....	Each

1. **Plastic Drum, Fluorescent, Furn** will be paid for as specified in subsection 812.04.C of the Standard Specifications for Construction.

2. **Plastic Drum, Fluorescent, Oper** will be paid for as specified in subsection 812.04.D of the Standard Specifications for Construction.

MICHIGAN
DEPARTMENT OF TRANSPORTATION

SPECIAL PROVISION
FOR
FLUORESCENT 42 INCH CHANNELIZING DEVICE

OFS:RAL

1 of 2

APPR:CRB:MWB:06-21-17
FHWA:APPR:07-21-17

a. Description. This work consists of furnishing, installing, maintaining, relocating, and removing a fluorescent 42 inch channelizing device as identified in the contract.

b. Materials. Provide a fluorescent 42 inch channelizing device that is crashworthy in accordance with the *National Cooperative Highway Research Program Report 350 (NCHRP 350)* or *Manual for Assessing Safety Hardware (MASH)*, in addition to meeting the following requirements:

1. Provide a plastic 42 inch channelizing device and ballast in accordance with the standard specifications.

2. Equip the 42 inch channelizing device with at least four 6-inch bands of reflective sheeting that meet the requirements of *ASTM D 4956* for reboundable Type IV Fluorescent Orange, and reboundable Type IV White. The topmost reflectorized stripe must be orange and alternate in color. The fluorescent orange sheeting must have a Daytime Luminance factor that meets or exceeds 20 based on *Table 2 of ASTM D 4956 - Daytime Luminance Factor (Y%)^A*. The white sheeting must have a Daytime Luminance factor that meets or exceeds 27 based on *Table 2 of ASTM D 4956 - Daytime Luminance factor (Y%)^A*.

A. Use sheeting from one of the following manufacturers or an approved equal:

(1) WR-7100 (white) and WR-7114(fluorescent orange), manufactured by Avery Dennison - Reflective Solutions, 7542 N. Natchez Ave. Nilus, IL, 60714, (877)-214-0909;

(2) 3910 (white) and 3914 (fluorescent orange) Diamond Grade Flexible Work Zone Sheeting, manufactured by 3M Traffic Safety & Security Division, 3M Center, 225-4N-14 St. Paul, MN, 55144, (800)-553-1380.

c. Construction. Install the fluorescent 42 inch channelizing device at locations as specified in the contract or as directed by the Engineer.

d. Measurement and Payment. The completed work, as described, will be measured and paid for at the contract unit price using the following pay items:

Pay Item	Pay Unit
Channelizing Device, 42 inch, Fluorescent, Furn.....	Each
Channelizing Device, 42 inch, Fluorescent, Oper	Each

1. **Channelizing Device, 42 inch, Fluorescent, Furn** will be paid for as specified in subsection 812.04.C of the Standard Specifications for Construction.

2. **Channelizing Device, 42 inch, Fluorescent, Oper** will be paid for as specified in subsection 812.04.D of the Standard Specifications for Construction.

MICHIGAN
DEPARTMENT OF TRANSPORTATION

SPECIAL PROVISION
FOR
TEMPORARY PEDESTRIAN TYPE II BARRICADE

OFS:RAL

1 of 2

APPR:CAL:CT:08-02-16

a. Description. This work consists of furnishing, installing, maintaining, relocating, and removing a temporary pedestrian Type II barricade section as identified in the proposal or on the plans. Use temporary pedestrian Type II barricades to close non-motorized facilities including sidewalks, bicycle paths, pedestrian paths, and shared use paths that are not part of the roadway. One pedestrian Type II barricade is defined as a barricade section at least 43 inches wide, including all supports, ballast, and hardware.

b. Materials. Provide a temporary pedestrian Type II barricade that meets the requirements of *National Cooperative Highway Research Program Report 350 (NCHRP 350)* or *Manual for Assessing Safety Hardware (MASH)*, in addition to meeting the following requirements:

1. Provide barricade sections at least 43 inches wide, designed to interconnect to ensure a continuous *Americans with Disabilities Act (ADA)* compliant tactile barrier. Ensure the connection includes provisions to accommodate non-linear alignment as well as variations in elevation at the installation area.

2. Ensure the top surface of the barricade is designed to function as a hand-trailing edge, and has a height between 32 and 38 inches. Ensure the lower edge of the barricade is no more than 2 inches above the surface of the non-motorized facility. Ensure the top edge of the bottom rail of the barricade is a minimum of 8 inches above the surface of the non-motorized facility. The barricade may have a solid continuous face. Finally, all features on the front face of the barricade (the face in contact with pedestrians) must share a common vertical plane.

3. Equip both sides of the barricade with bands of alternating 6-inch wide orange and white vertical stripes of reflective sheeting. Two bands of sheeting 6 inches tall and a minimum of 36 inches long containing at least two orange and two white stripes each are required. One band placed near the top and one near the bottom if the barricade section has a solid face. If the barricade consists of two rails, affix one band of sheeting to each rail. Ensure the stripes of reflective sheeting are aligned vertically. Ensure this sheeting meets or exceeds the requirements of *ASTM D 4956* Type IV sheeting.

c. Construction. Construct the temporary pedestrian Type II barricade in accordance with the manufacturer's recommendations, Michigan Manual on Uniform Traffic Control Devices (MMUTCD), the plans, and the following requirements:

1. Install the barricade as shown on the plans and as directed by the Engineer. Interconnect all barricade sections using hinge components if necessary to ensure a continuous detectable edge for the entire installation. Ensure the barricade is ballasted according to the manufacturer's recommendations to ensure stability during wind events and contact with pedestrians.

2. When the barricade is installed near motor vehicle traffic, ensure reflective sheeting is visible to motorists.

3. When pedestrian Type II barricades are used to close a non-motorized facility, ensure a sufficient number of barricade sections are used to block the entire width of the facility. The barricade may extend outside the edge of the non-motorized facility but must not be less than the full width of the facility.

4. If sections of multiple colored barriers are used (i.e. safety orange and white) install the sections such that the colors alternate to increase conspicuity.

5. Ensure pedestrian Type II barricades are not used to close a motor vehicle facility. Ensure these barricades are not used to guide pedestrian traffic on a motor vehicle facility in the presence of active traffic. This prohibition includes bicycle/shared use lanes or shoulders in the presence of active traffic.

d. Measurement and Payment. The completed work, as described, will be measured and paid for at the contract unit price using the following pay item:

Pay Item	Pay Unit
Pedestrian Type II Barricade, Temp	Each

Pedestrian Type II Barricade, Temp, includes all labor, equipment, and materials to furnish, install, maintain, relocate, and remove one barricade section that is at least 43 inches wide. Additional payment will not be made if wider sections are provided. This includes all rails, supports, ballast, hinge points, reflective sheeting, and miscellaneous hardware needed to install and maintain a barricade section.

MICHIGAN
DEPARTMENT OF TRANSPORTATION

SPECIAL PROVISION
FOR
TEMPORARY PEDESTRIAN TYPE II CHANNELIZER

OFS:RAL

1 of 2

APPR:CAL:CT:05-06-16

a. Description. This work consists of furnishing, installing, maintaining, relocating, and removing temporary pedestrian channelizers as identified in the proposal or on the plans. Use temporary pedestrian channelizers to guide pedestrians along a temporary non-motorized facility, and to create separation of pedestrians from construction areas near existing facilities. Replace damaged temporary pedestrian Type II channelizers as directed by the Engineer.

b. Materials. Provide a temporary pedestrian channelizer that is crashworthy according to the *National Cooperative Highway Research Program Report 350* (NCHRP 350) or *Manual for Assessing Safety Hardware* (MASH), in addition to meeting the following requirements:

1. Ensure the channelizer is designed to interconnect to maintain continuous delineation along the entire installation. This includes provisions to accommodate non-linear alignment as well as variations in elevation.

2. Ensure the top surface of the channelizer is designed to function as a hand-trailing edge, and have a height between 32 and 38 inches. Ensure this top surface is designed to have a 2 inch horizontal gap between the top edge and the support (if so equipped), to allow for continuous hand-trailing without obstructions. Ensure the lower edge of the channelizer is no more than 2 inches above the surface of the non-motorized facility. Ensure the top edge of the bottom rail of the channelizer is a minimum of 8 inches above the surface of the non-motorized facility or the channelizer may have a solid continuous face. Finally, all features on the front face of the channelizers (the face in contact with pedestrians) must share a common vertical plane.

3. Equip both sides of the channelizer with bands of alternating 6-inch wide orange and white vertical stripes of reflective sheeting. Two bands of sheeting 6 inches tall and a minimum of 36 inches long containing at least two orange and two white stripes each are required. One band placed near the top and one near the bottom if the channelizer section has a solid face. If the channelizer consists of two rails, affix one band of sheeting to each rail. Ensure the stripes of reflective sheeting are aligned vertically. Ensure this sheeting meets or exceeds the requirements of *ASTM D 4956* Type IV sheeting.

c. Construction. Deploy the temporary pedestrian Type II channelizer in accordance with the manufacturer's recommendations, the Michigan Manual on Uniform Traffic Control Devices (MMUTCD), the plans, and the following requirements:

1. Install the channelizer as shown on the plans and as directed by the Engineer. Interconnect all channelizers using hinge components if necessary to ensure a continuous detectable edge for the entire installation. Ensure the channelizers are ballasted according to the manufacturer's recommendations to ensure stability during wind events and contact with pedestrians.

2. When the channelizers are installed near motor vehicle traffic, ensure reflective sheeting is visible to motorists providing appropriate delineation for the pedestrian path.

3. If sections of multiple colored barriers are used (i.e safety orange and white), install the sections such that the colors alternate to increase conspicuity.

4. Ensure temporary pedestrian Type II channelizers are not used to guide pedestrian traffic on a motor vehicle facility in the presence of active traffic. This prohibition includes bicycle/shared use lanes or shoulders in the presence of active traffic. Ensure temporary pedestrian channelizers are not used to channelize motor vehicle traffic, or separate motor vehicle and pedestrian traffic.

d. Measurement and Payment. The completed work, as described, will be measured and paid for at the contract unit price using the following pay item:

Pay Item	Pay Unit
Pedestrian Type II Channelizer, Temp.....	Foot

Pedestrian Type II Channelizer, Temp includes all labor, equipment, and materials to furnish, install, maintain, relocate and remove rails or wall sections, supports, ballast, and hinge points at the locations shown on the plans. This includes all rails or wall sections, supports, ballast, hinge points, and miscellaneous hardware needed to construct the channelizer or system of channelizers.

MICHIGAN
DEPARTMENT OF TRANSPORTATION

SPECIAL PROVISION
FOR
INDUSTRIAL BY-PRODUCTS AND BENEFICIAL RE-USE

ENV:HLZ

1 of 1

APPR:JJG:JFS:09-11-14

APPR: FHWA: 09-11-14

a. Description. For this project, regardless of the application, the use of industrial by-products, covered in 2014 PA 178, is prohibited unless the use and application of a particular material is covered elsewhere in the contract.

MICHIGAN
DEPARTMENT OF TRANSPORTATION

SPECIAL PROVISION
FOR
CRUSHED CONCRETE NEAR WATER

CFS:JFS

1 of 1

APPR:KAS:DBP:02-24-12
FHWA:APPR:02-24-12

Add the following paragraph after the first paragraph of Subsection 902.05 on page 743 of the Standard Specifications for Construction:

The use of crushed concrete is prohibited on the project within 100 feet of any water course (stream, river, county drain, etc.) and lake, regardless of the application or location of the water course or lake relative to the project limits.

Add the following paragraph after the first paragraph of Subsection 902.06 on page 743 of the Standard Specifications for Construction:

The use of crushed concrete is prohibited on the project within 100 feet of any water course (stream, river, county drain, etc.) and lake, regardless of the application or location of the water course or lake relative to the project limits.

Add the following paragraph after the fourth paragraph of Subsection 902.07 on page 744 of the Standard Specifications for Construction:

The use of crushed concrete is prohibited on the project within 100 feet of any water course (stream, river, county drain, etc.) and lake, regardless of the application or location of the water course or lake relative to the project limits.

MICHIGAN
DEPARTMENT OF TRANSPORTATION

SPECIAL PROVISION
FOR
ALTERNATIVE GRANULAR MATERIALS FOR FILL AND SUBBASE

CFS:SAB

1 of 1

APPR:JFS:DMG:04-03-12
FHWA:APPR:04-09-12

Delete subsection 902.07.A, on page 744, of the Standard Specifications for Construction, in its entirety and replace with the following:

A. Class I, Class IIAA, or Dense-Graded Aggregate 21A, 21AA and 22A material for Class II material;

Delete subsection 902.07.B, on page 744, of the Standard Specifications for Construction, in its entirety and replace with the following:

B. Class I, Class II, Class IIA, Class IIAA, Class IIIA or Dense-Graded Aggregate 21A, 21AA and 22A material for Class III material;

Delete subsection 902.07.C, on page 744, of the Standard Specifications for Construction, in its entirety and replace with the following:

C. Class I material for Class IIAA material; and

Add the following subsection to Section 902.07, on page 744, of the Standard Specifications for Construction.

D. Dense-Graded Aggregate 21A, 21AA and 22A material for Class IIA.

MICHIGAN
DEPARTMENT OF TRANSPORTATION

SPECIAL PROVISION
FOR
SUPERPAVE FINAL AGGREGATE BLEND REQUIREMENTS

CFS:KPK

1 of 2

APPR:JFS:CJB:05-31-18

FHWA:APPR:06-06-18

a. Description. This special provision establishes the Superpave final aggregate blend gradation requirements and the Superpave final aggregate blend physical requirements.

b. Materials. Replace Table 902-5 and Table 902-6 of the Standard Specifications for Construction with the following tables.

Table 902-5						
Superpave Final Aggregate Blend Gradation Requirements						
Standard Sieve	Percent Passing Criteria (control points)					
	Mixture Number					
	5	4	3 Leveling Course	3 Base Course	2	LVSP (a)
1½ inch	—	—	—	—	100	—
1 inch	—	—	100	100	90–100	—
¾ inch	—	100	90–100	90–100	≤90	100
½ inch	100	90–100	≤90	≤90	—	75–95
⅜ inch	90–100	≤90	—	—	—	60–90
No. 4	≤90	—	—	—	—	45–80
No. 8	47-67	39-58	35–52	23–52	19–45	30–65
No. 16	—	—	—	—	—	20–50
No. 30	—	—	—	—	—	15–40
No. 50	—	—	—	—	—	10–25
No. 100	—	—	—	—	—	5–15
No. 200	2.0–10.0	2.0–10.0	2.0–8.0	2.0–8.0	1.0–7.0	3–6
a. For LVSP, less than 50 percent of the material passing the No. 4 sieve may pass the No. 30 sieve.						

Table 902-6

Superpave Final Aggregate Blend Physical Requirements													
Est. Traffic (million ESAL)	Mix Type	Percent Crushed Minimum Criteria		Fine Aggregate Angularity Minimum Criteria		% Sand Equivalent Minimum Criteria		Los Angeles Abrasion % Loss Maximum Criteria		% Soft Particles Maximum Criteria (a)		% Flat and Elongated Particles Maximum Criteria (b)	
		Top & Leveling Courses	Base Course	Top & Leveling Courses	Base Course	Top & Leveling Courses	Base Course	Top & Leveling Courses	Base Course	Top & Leveling Courses	Base Course	Top & Leveling Courses	Base Course
< 0.3	LVSP	55/—	—	—	—	40	40	45	45	10	10	—	—
< 0.3	E03	55/—	—	—	—	40	40	45	45	10	10	—	—
≥0.3 - <1.0	E1	65/—	—	40	—	40	40	40	45	10	10	—	—
≥1.0 - < 3	E3	75/—	50/—	43	40	40	40	35	40	5	5	10	10
≥3 - <10	E10	85/80	60/—	45	40	45	45	35	40	5	5	10	10
≥10 - <30	E30	95/90	80/75	45	40	45	45	35	35	3	4.5	10	10
≥30 - <100	E50	100/100	95/90	45	45	50	50	35	35	3	4.5	10	10

(a) Soft particles maximum is the sum of the shale, siltstone, ochre, coal, clay-ironstone and particles that are structurally weak or are non-durable in service.
 (b) Maximum by weight with a 1 to 5 aspect ratio.

Note: "85/80" denotes that 85 percent of the coarse aggregate has one fractured face and 80 percent has at least two fractured faces.

MICHIGAN
DEPARTMENT OF TRANSPORTATION

SPECIAL PROVISION
FOR
STEEL REINFORCEMENT REVISIONS

OFS:MJF

1 of 2

APPR:JSW:POJ:12-19-18
FHWA:APPR:12-19-18

Delete the first three paragraphs under subsection 905.03, on page 767 of the Standard Specifications for Construction, and replace with the following:

905.03 Steel Bar Reinforcement for Structures. Deformed steel bars used for non-prestressed concrete reinforcement must meet the requirements of ASTM A615 Grade 60, ASTM A706 Grade 60, or ASTM A996 (Type A or Type R) Grade 60, unless otherwise required.

Deformed steel bars used for prestressed concrete reinforcement must meet the requirements of ASTM A615 Grade 60, ASTM A706 Grade 60, or ASTM A996 (Type A) Grade 60, unless otherwise required.

Delete subsection 905.03.C on page 768 of the Standard Specifications for Construction, in its entirety and replace with the following:

C. Epoxy Coating. Epoxy coated steel reinforcement bars must be coated in accordance with ASTM A775. Epoxy coated steel welded wire reinforcement must be coated in accordance with ASTM A884, Class A, Type 1. The following exceptions and additions apply:

1. Select coating material from the Qualified Products List.
2. The Department may test samples to determine thickness of coating, adhesion of coating, and holidays. Coat more steel reinforcement than shown on the plans to allow splicing to replace steel reinforcement removed for test samples.
3. Include written certification that the reinforcing bars or steel welded wire reinforcement were cleaned, coated, and tested in accordance with ASTM A775 or ASTM A884, as applicable, from the coating applicator.
4. Repair damage to the coating in accordance with subsection 706.03.E.8.

Delete the first paragraph under subsection 905.05, on page 768 of the Standard Specifications for Construction, in its entirety and replace with the following:

Deformed steel bars must meet the requirements of ASTM A615 Grades 40, 50, or 60, ASTM A706, or ASTM A996 (Type A or Type R).

Delete subsection 905.06, on page 768 of the Standard Specifications for Construction, in its entirety and replace with the following:

905.06 Steel Welded Wire Reinforcement. Welded steel wire reinforcement must meet the requirements of ASTM A1064 and fabricated as required.

MICHIGAN
DEPARTMENT OF TRANSPORTATION

SPECIAL PROVISION
FOR
PHYSICAL REQUIREMENTS FOR GEOTEXTILES

CFS:RBE

1 of 1

APPR:DMG:RWS:08-06-15

FHWA:APPR:08-11-15

Delete Table 910-1 on page 813 of the Standard Specifications for Construction in its entirety and replace with the following:

Table 910-1: Physical Requirements for Geotextiles

Geotextile Category	Property				
	Grab Tensile Strength (minimum) (pounds)	Trapezoid Tear Strength (minimum) (pounds)	CBR Puncture Strength (minimum) (pounds)	Permittivity per second (minimum)	Apparent Opening Size (maximum) (millimeters)
	Test Method				
	<i>ASTM D 4632</i>	<i>ASTM D 4533</i>	<i>ASTM D 6241</i>	<i>ASTM D 4491</i>	<i>ASTM D 4751</i>
Geotextile Blanket (a)	90	45	230	0.5	0.21
Geotextile Liner	200	75	440	0.5	0.21
Heavy Geotextile Liner	270	100	620	0.5	0.21
Woven Geotextile Separator (<50% elongation)	270	100	620	0.05	0.425
Non-Woven Geotextile Separator (>50% elongation)	200	75	440	0.05	0.425
Stabilization Geotextile	270	100	620	0.05	0.50
Silt Fence	100 (b)	45	---	0.1	0.60
Drainage Geocomposites	90	45	230	0.5	0.21
<p>a. For pipe wrap where backfill around the pipe meets granular material Class IIAA requirements; geotextiles, including knitted polyester sock, which meet the following minimum requirements in the applied condition are permitted: Mass/Unit Area: 3.0 oz/yd²; Mullen burst strength: 100 psi; maximum apparent opening size must be 0.30 mm for pavement and foundation underdrains, and 0.60 mm in other areas. The fluid displacement rate for the Mullen burst test equipment must be 170 mL/min ±5 mL/min. Subtract tare strength from the ultimate burst strength as specified in <i>ASTM D 3786</i>.</p> <p>b. Elongation at the specified grab tensile strength no greater than 40% for silt fence.</p>					

MICHIGAN
DEPARTMENT OF TRANSPORTATION

SPECIAL PROVISION
FOR
HOT-POURED SEALANT FOR CONSTRUCTION

CFS:ARB

1 of 1

APPR:RAG:TES:06-11-18
FHWA APPR:06-11-18

Delete subsection 914.04, on pages 836 and 837 of the Standard Specifications for Construction, in its entirety and replace with the following:

914.04. Hot-Poured Sealant. Provide a material listed in Table 914-1 or an approved equal, as determined by the Engineer.

Table 914-1 Hot-Poured Sealant	
Product Name	Manufacturer
MACSEAL 6690-4 MOD	McAsphalt, Ind.
Roadsaver 522	Crafco
Deery 101 ELT	Crafco
RP Type 3725	Right Pointe
Elastoflex 72	Maxwell Products
Dura-Fill 3725	P & T Products
3405-M Michigan	W.R. Meadows

Legibly mark material containers with a non-fading, weather-resistant ink or paint. Include the manufacturer's name or trade name, batch number, recommended pouring temperature, and the maximum safe heating temperature on the label.

Where required, use a backer rod meeting the requirements of *ASTM D 5249, Type 1*.

MICHIGAN
DEPARTMENT OF TRANSPORTATION

SPECIAL PROVISION
FOR
ELECTRICAL AND LIGHTING CONDUIT

UTL:SJU

1 of 1

APPR:MWB:LWB:01-13-15
FHWA:APPR:01-27-15

Delete the first sentence in subsection 918.01, on page 857 of the Standard Specifications for Construction, and replace with the following:

Provide conduits listed and appropriately labeled by a Nationally Recognized Testing Laboratory (NRTL), as recognized by the Occupational Safety and Health Administration (OSHA), with ultraviolet protection and manufactured for use at temperatures of at least 194 degrees F unless otherwise required.

Delete the second sentence in subsection 918.01.A, on page 857 of the Standard Specifications for Construction, and replace with the following:

Provide galvanized steel conduit manufactured in accordance with UL 6.

MICHIGAN
DEPARTMENT OF TRANSPORTATION

SPECIAL PROVISION
FOR
PERMANENT PAVEMENT MARKING MATERIALS

PMK:MKB

1 of 4

APPR:MWB:CRB:02-05-19
FHWA:APPR:02-21-19

Delete the content of section 920, on page 890 of the 2012 Standard Specifications for Construction in its entirety and replace it with the following:

920.01. Marking Materials. Select pavement marking materials from the Qualified Products List unless specified otherwise by special provision in the contract.

When selecting preformed thermoplastic products, ensure preformed thermoplastic materials have a thickness of 90 mils for surface applications and a thickness of 125 mils for recessed applications. For black liquid shadow markings and blue markings used in parking areas, choose a specified binder material and color from the Qualified Products List or select a white specified binder material from the Qualified Products List and tint the product to the appropriate color.

Use liquid applied pavement marking materials manufactured in the previous 12 months or within the shelf-life directed by the manufacturer, whichever is less. Use solid applied materials within the shelf-life directed by the manufacturer. Provide certification that liquid and solid applied pavement marking materials have been stored per the manufacturer's requirements. Materials not in compliance will be rejected and removed at the Contractor's expense.

Pavement marking materials must meet the general packaging and labeling requirements of subsection 920.01.A, and applicable specific material requirements of subsection 920.01.B.

A. General Packaging and Labeling. Material containers or packages must be marked on the tops and sides, using a durable, weather-resistant marking. Include the following information:

1. Manufacturer's name and address,
2. Description of the material,
3. Product identification number,
4. Lot or Batch number,
5. Date of manufacture,
6. Volume and
7. Weight.

B. Packaging and Labeling for Cold Plastic and Thermoplastic Markings.

1. **Cold Plastic.** Containers or packages of cold plastic material and the core of each roll must be marked with the information specified in subsection 920.01.A.
2. **Thermoplastic.** In addition to the requirements of subsection 920.01.A, thermoplastic material must be packaged in non-stick containers, and labeled with "heat to manufacturer-recommended temperature range," or a Department-approved equal.

920.02. Glass Beads and Wet Reflective Optics.

A. Glass Bead and Wet Reflective Optics Packaging and Labeling. Glass beads and wet reflective (WR) optics must be packaged in moisture resistant bags and labeled to include the following information:

1. Manufacturer's name and address,
2. Shipping point,
3. Trademark or name,
4. The wording "Glass Beads" or "the appropriate optic type",
5. Specification number,
6. Weight,
7. Lot or Batch number, and
8. Date of manufacture.

Drop-on AASHTO M247 Type I beads, herein referred to as standard glass beads, must meet the general requirements of subsection 920.02.B and the applicable requirements for specific applications of subsection 920.02.D. WR optics must meet the general requirements of subsection 920.02.C and the applicable requirements for specific applications of subsection 920.02.D. Large glass beads must meet federal specification TTB-1325 for a Type 4 glass bead.

All glass beads and WR optics to be used on Federal-aid projects must contain no more than 200 parts per million of arsenic or lead, as determined in accordance with Environmental Protection Agency testing methods 3052, 6010B, or 6010C.

B. General Requirements for Standard Glass Beads. Standard glass beads must meet the physical characteristics and gradation requirements specified in Table 920-1, unless otherwise specified in subsection 920.02.D for specific applications.

Table 920-1 General Requirements for Standard Glass Bead	
Physical characteristics (MTM 711)	
General Appearance	Transparent, clean, smooth, free from milkiness, pits, or excessive air bubbles
Shape	Spherical with $\geq 75\%$ true spheres

Color	Colorless, very light gray, very light gray tinge, or bright white
Index of Refraction	≥1.50
Alkalinity	≤2.0
Gradation Requirements (MTM 711)	
Sieve Size (No.)	Total Percent Passing
20	100
30	75–95
50	15–35
100	0–5

C. **General Requirements for WR Optics.** WR optics must meet the retroreflectivity requirements specified in Table 920-2.

Table 920-2		
General WR Optics Requirements		
Average Initial Retroreflectivity at 30 meter geometry in mcd/lux/m²		
Test Method	Color	
	White	Yellow
Dry (ASTM E 1710)	700	500
Wet Recovery (ASTM E 2177)	250	200
Wet Continuous (ASTM E 2832)	100	75

D. **Glass Bead and WR Optics Requirements for Specific Applications.** For specific applications, glass beads and WR optics must be as follows:

1. For recessed longitudinal markings, use a double drop system of large and standard glass beads, a double drop system of WR optics and standard glass beads, or an Engineer-approved alternate.
2. **Waterborne and Low Temperature Waterborne.** Standard and large glass beads for use with waterborne marking material and low temperature waterborne marking material require a moisture resistant coating and a silane coating. The type, gradation, and application rates for WR optics used with waterborne and low temperature waterborne marking materials must meet the waterborne manufacturer's recommendations.
3. **Regular Dry.** Standard and large glass beads for use with regular dry marking material may have a moisture resistant coating, a silane coating, or both. The type, gradation, and application rates for WR optics used with regular dry marking materials must meet the regular dry manufacturer's recommendations.
4. **Thermoplastic.** Standard and large glass beads for thermoplastic marking material must have a moisture resistant coating. The type, gradation, and application rates for WR optics

used with thermoplastic marking materials must meet the thermoplastic manufacturer's recommendations.

5. **Sprayable Thermoplastic.** The type, gradation, and application rates for standard and large glass beads and WR optics used with sprayable thermoplastic marking material must meet the sprayable thermoplastic manufacturer's recommendation.
6. **Polyurea.** The type, gradation, and application rates for standard and large glass beads and WR optics used with polyurea marking material must meet the polyurea manufacturer's recommendation.
7. **Modified Urethane.** The type, gradation, and application rates for standard and large glass beads and WR optics used with modified urethane marking material must meet the modified urethane manufacturer's recommendation.

MICHIGAN
DEPARTMENT OF TRANSPORTATION
SUPPLEMENTAL SPECIFICATION
FOR
ERRATA TO THE 2012 STANDARD SPECIFICATIONS

1 of 30

03-04-19

Page	Subsection	Errata
N/A	N/A	In the very beginning of the book on the page where we list the MDOT publications included by reference delete the following manual. "Work Zone Safety and Mobility Manual"
N/A*	N/A	In the very beginning of the book on the page where we list the MDOT publications included by reference replace the Field Manual of Soil Engineering (out of Print) with the following manual. "Geotechnical Manual"
3	101.02	Modify the abbreviation reading "AIS" to read "AISI".
4*	101.02	Delete the following abbreviations and the long forms MDELEG MDNRE Add the following abbreviations and the long forms MDNR Michigan Department of Natural Resources MDEGLE Michigan Department of Environmental Great Lakes, and Energy MDLARA Michigan Department of Licensing and Regulatory Affairs NESC National Electrical Safety Code
27	103.02.B.2	Change the last sentence of the first paragraph to read "For decreases below 75 percent, the maximum allowable payment for work performed, including any adjustment, will not exceed an amount equal to 75 percent of the original contract quantity times the contract unit price."
34	104.05	The first sentence of this subsection should read "If the Contractor performs unauthorized work (work performed without the inspections required by the contract, extra work performed without Department approval, work performed contrary to the inspectors direction, or work performed while under suspension by the inspector), the Engineer may reject the unauthorized work."
46	104.12	Add the following to the end of the first paragraph "The use of right-of-way in wetlands and floodplains, or the crossing of water courses by construction equipment is prohibited."
53	105.09	Add the following to the end of the second paragraph "Any specifically produced material not purchased by the Department, will remain the

Page	Subsection	Errata		
		Contractors and must be removed from the project prior to final acceptance."		
56	107.02.B.2	This sentence should read "U.S.Army Corps of Engineers' Section 404, Dredge and Fill; and Section 10, Navigable Waterway."		
56*	107.02.B	Add the subsection reading as follows: "3. U.S. Coast Guard Section 9, Navigable Waterway." Change "MDNRE" to "MDEGLE" in this subsection.		
64	107.12	Change the first sentence of the first paragraph to read: "For protection of underground utilities and in accordance with 2013 PA 174, the Contractor must notify Miss Dig at least 3 work days, excluding Saturdays, Sundays and holidays, before beginning each excavation in areas where public utilities have not been previously located."		
65*	107.15.A	Change "MDNRE" to "MDEGLE" in four instances in this subsection.		
66	107.15.A.3	Add the following to the end of the paragraph "Note that a burn permit from the MDNR is required for any open burning whenever the ground is not snow covered. Any individuals that allow a fire to escape will be in violation of the Natural Resources and Environmental Protection Act and will be required to reimburse the costs of suppressing the wild fire."		
67*	107.16	The third sentence should read "In State Forests, the Contractor must contact the local Unit Manager, Forest Management Division, MDNR, regarding the work to be performed within or adjacent to the forest land." Delete the last sentence of the first paragraph of this subsection.		
80	108.08.F	Delete the second paragraph in its entirety.		
80	108.08.G	Add the following new subsection: "G. The Contractor may propose and the Engineer may approve another equitable method, supported by an acceptable rationale to determine time extensions for any of the excusable delays listed in subsection 108.08.		
83	108.10.C	Change the last sentence of the first paragraph to read: "The liquidated damages may contain one or more components of damages added together."		
83	108.10.C.1	In Table 108-1 delete the last row of the table and replace it with the following: <table border="1" style="margin-left: 40px;"> <tr> <td style="width: 60%;">≥50,000,000</td> <td style="width: 40%;">4,500</td> </tr> </table>	≥50,000,000	4,500
≥50,000,000	4,500			
102	109.05.E.1	Change the second sentence of the third paragraph to read: "Provide the content specified in subsection 109.05.D.11 for the applicable items in this statement and as follows:"		

Page	Subsection	Errata
107	150.04	Change the following pay item reading "Mobilization, Max ___" to read "Mobilization, Max (dollar)" at nine locations throughout the subsection.
112	201.03.A.3.b	Change "MDNRE" to "MDNR" in three instances in this subsection.
123	204.04	Change the following pay item reading "Structures, Rem" to read "Structures, Rem (Structure No.)"
123	204.04	Change the following pay item reading "Concrete Barrier, Rem" to read "Conc Barrier, Rem"
150*	208.01	Change "MDNRE" to "MDEGLE" in this subsection.
180	308.03.A	Change the first sentence of the second paragraph to read: "Do not operate equipment required to place backfill directly on geotextile products."
185	401.03.A	Change the first sentence of the second paragraph to read: Where unstable soil conditions, or obstructions other than rock, require excavation of the trench below the elevation detailed on the plans; undercut, backfill, and compact the trench as directed by the Engineer.
188	401.03.H	Change the second sentence of the paragraph to read "Jack steel pipes in place in accordance with subsection 401.03.G".
189	401.03.N	Add the following sentence to the end of the first paragraph "Where possible, maintain the stream flow thru a temporary channel or temporary culvert." The second sentence of the second paragraph should read "Direct water from the dewatering operations through a filter bag before discharging to an existing drainage facility."
189	401.04	Change the fourth pay item from the end of the list to read as follows: "Culv, Reinf Conc Ellip, (shape) CI __, (rise) inch x (span) inch".
190	401.04	Change the fourth pay item from the end of the list to read as follows: "Steel Casing Pipe, __ inch, Tr Det __."
195	402.03.C	Change the third sentence of the first paragraph to read as follows: "Wrap pipe joints, with a diameter greater than 24 inches, using geotextile blanket."
200	402.04	Change the third pay item from the top of the list to read as follows: "Sewer, CI __, __ inch, Jacked in Place"
200	402.04.A	Change the last sentence of the subsection to read as follows: "The unit price for Sewer and Sewer, Reinf Conc, Ellip includes the cost of excavation, backfill, geotextile blanket and mandrel testing."

Page	Subsection	Errata
201*	402.04.H	Change the last sentence of the first paragraph to read "The Department will not make an adjustment in the pay items of Minor Traf Devices or Traf Regulator Control. "
208	403.04.D.3	Change the sentence to read: "Removing and replacing pavement adjacent to the adjusted cover per Standard Plan R-37 Series."
218	406.03.A.2	Change the first sentence of the first paragraph to read: "Design precast box culverts less than 10 feet in span length measured along the centerline of the roadway in accordance with current AASHTO LRFD Bridge Design Specifications and ASTM C 1577." Add the following sentence to the end of the first paragraph: "Design precast box culverts greater than or equal to 10 feet in span length measured along the centerline of the roadway for HL-93 Modified live load."
219	406.03.B	Change the first sentence of the first paragraph to read: "Submit shop drawings for culverts greater than or equal to 10 feet in span length measured along the centerline of the roadway to the Engineer, for review and approval in accordance with subsection 104.02."
219	406.03.C.1	Change the second sentence of the first paragraph to read: "Before manufacture, perform load ratings on precast three-sided, arch or box culverts greater than or equal to 10 feet in span length measured along the centerline of the roadway, in accordance with the AASHTO Manual of Bridge Evaluation, Section 6, Part A, the Michigan Bridge Analysis Guide current at the time load rating is performed, and the Michigan Structure Inventory and Appraisal Guide."
223	406.03.G	Add the following after the first sentence of the second paragraph: "Where possible, maintain the stream flow thru the existing channel, temporary channel, or temporary culvert."
224	406.03.G	Replace the fifth paragraph of this subsection with the following: "The Contractor may use cast-in-place wing walls, headwalls, and aprons, as alternatives to precast wing walls, headwalls, and aprons. Attach cast-in-place wing walls or headwalls as shown on the shop drawings."
225	406.03.G.2	Change the third sentence of the first paragraph to read: "Before placing the open-graded aggregate 34R, compact the coarse aggregate 6A using at least three passes of a vibrating plate compactor."
226	406.03.G.2	Change the first sentence of the second paragraph of this subsection to read:

Page	Subsection	Errata
		"Fill the space between the box culvert joints during placement of box sections with closed-cell rubber extrusion type gaskets in accordance with ASTM C 990."
226	406.04.A.9	Change the sentence to read: "Providing plan modifications including design, additional plan quantities and pay items to accommodate any changes to the precast units as shown on the plans."
226*	406.04.A	Add the following paragraph after the last paragraph of the subsection: "The substructure design is specific to the three-sided or arch culvert detailed on the plans. The Contractor must use approved MDOT service vendors qualified in Hydraulics, Geotechnical Engineering Services, and Short and Medium Span Bridges to perform the required design and plan modifications, as directed by the Engineer, if the Contractor selects a culvert shape different than shown on the plans."
227	406.04.B	Add the following new item in the list of items in this subsection: 2. Headwalls, wingwalls, aprons, and curtain walls, precast or cast-in-place; Renummer the exist items 2 through 4 in this list to read 3 through 5. Delete existing item numbered 5 and replace with the following: 6. Inserts for bars and connection hardware; and Renummer the existing item 6 in this list to read 7.
227	406.04.B	Delete the first and second paragraphs following the list of items in this subsection and replace with the following: "The Department will pay separately for cast-in-place concrete, other than for culvert segments, wing walls, and headwalls; excavation; protective coating; providing and placing backfill material; by plan quantity in accordance with subsection 109.01.A."
239	501.03.C.6	The first sentence of this subsection should read "Except as specified in subsection 501.03.C.4, removing HMA surface applies to removing HMA overlying a material designated for removal or that is required to remain in place."
247	501.03.O	Change footnote e in Table 501-5 to read: "Flushing severe enough to significantly affect surface friction (Friction Number <35)."
249	501.04.H	The first sentence of this subsection should read "The Engineer will measure, and the Department will pay for removing HMA surface, no greater than 12 inches thick, overlying a material designated for removal or that is required to remain in place, as HMA Surface, Rem. "

Page	Subsection	Errata
		The second paragraph of this subsection should read "The Engineer will measure, and the Department will pay for removing HMA surface, greater than 12 inches thick, overlying a material designated for removal or that is required to remain in place, as Pavt, Rem in accordance with subsection 204.04."
257	503.03.E	Delete this subsection in its entirety.
265	504.03.E.3	Delete this subsection in its entirety.
269	504.04.A	This subsection should read "The unit prices for Micro-Surface , regardless of the type required, include cleaning existing pavement; applying a bond coat; temporary pavement markings; stationing; corrective action; and traffic control to complete corrective action."
299	601.04	In table 601-2 delete the row for Grade P-NC concrete in its entirety.
300	601.04	In table 601-2, the first sentence of footnote b. should read: "Use coarse aggregate 6A, 6AA or 6AAA for Grades P1, P2 and M." In table 601-2, footnote c. should read: "The mix design basis for bulk volume (dry, loose) of course aggregate per unit volume of concrete is 72% for Grade P1; 74% for Grade P2."
308	602.03.F	Note c. in Table 602-1 should read "Refer to Section D6 of the Materials Quality Assurance Procedures Manual for inspection procedure."
320	602.04.C.3	The last paragraph in this subsection should read "If the Engineer approves a substitution of a higher concrete grade for a lesser grade (e.g., P1 for P2), the Department will pay for the higher grade of concrete using the original bid and pay items of the lesser grade."
327	603.02	Change the second material in the list to read: "Concrete, Grade P-NC.....603" Change the third material in the list to read: "Base Course Aggregate, 4G, 21AA, 22A.....902"
334	603.03.B.10	Change the last sentence of the second paragraph to read "Apply the required curing compound in two coats, at a rate of at least 1 gallon per 25 square yards for each coat."
342	603.04.G.3	Change "D1" to "W" in two instances in this subsection.
351	701.04	Replace Tables 701-1A and 701-1B with the Table 701-1 below.
362*	704.03.C	Change the last sentence in the first paragraph of this subsection to read: "The Engineer will consider approval after receiving applicable MDEGLE permits for the alternate method."

Page	Subsection	Errata
372	705.03.C.1	Add the following sentence after the first paragraph of this subsection: "Do not drive piles within a radius of 25 feet of newly placed concrete until the concrete attains at least 75 percent of its specified minimum strength."
374	705.03.C.2.c	Change the last sentence of the second paragraph to read "Drive test piles to the minimum pile length or practical refusal, whichever is greater".
379	705.04	Change the fifth item down the list to read: "Pile, Galv (Structure No.)"
380	705.04	Change the last item in the list to read: "Pile Driving Equipment, Furn (Structure No.)"
383	706.02	The fourth paragraph following the list of materials should read "Provide AASHTO M 270, Grade 36 steel, meeting the requirements of ASTM A 786, galvanized in accordance with section 707, for expansion joint cover plates. Provide plates at least 3/8 inch thick. Use plates with a slip resistance equal to or greater than those meeting the requirements of ASTM A 786 and must be approved by the Engineer. Provide ASTM F 593 (Type 304) stainless steel, 3/4-inch or 1/2-inch diameter, flathead countersunk screws with 3/4-inch or 1/2-inch diameter inserts for use in expansion joint cover plates."
389	706.03.D.4.b	Change the first sentence of the fourth paragraph to read "Design forms, form supports, and attachments to carry dead loads, and resultant horizontal loads due to forming of cantilever overhangs."
390	706.03.E.4	Change the fourth sentence of the first paragraph to read: "Use wire ties to secure all bar intersections for the top mat. Use wire ties to secure all bar intersections for other mats where the product of the length and width of bar intersection spacing exceeds 120 square inches."
391	706.03.E.8	Change the first sentence of the second paragraph of this subsection to read: "Patch sawed or sheared ends and visible defects in accordance with ASTM A 775."
392	706.03.E.8	Change the last sentence of the third paragraph of this subsection to read: "Coat mechanical splices after splice installation in accordance with ASTM A 775 for patching damaged epoxy coating."
394	706.03.H.1	Delete the last paragraph on page 394 and replace it with the following: "Do not cast sidewalk, curb, or barrier pours until the deck concrete attains at least the minimum specified 7-day flexural or compressive strength, and after completion of the 7-day continuous wet cure. The

Page	Subsection	Errata
		forming of succeeding portions may occur, provided the wet cure is maintained."
406*	706.03.N.1.b	Add the following to the end of the last paragraph of the subsection: "Do not discontinue wet cure nor cast succeeding portions onto the bridge deck prior to completion of the 7-day two-phase continuous wet cure. Ensure excess or ponding cure water is removed prior to casting of succeeding structure portions."
416	707.03.C.1	Change the title of the subsection from "Shop Plans to read "Shop Drawings". Change the second sentence of this subsection to read: "Do not use design drawings in lieu of shop drawings."
426	707.03.C.17	Change the second sentence in the first paragraph of this subsection to read: "Tap oversized galvanized nuts in accordance with ASTM A 563 or AASHTO M 292 and meet Supplementary Requirement S1 of ASTM A 563 or AASHTO M 292."
430	707.03.D.7.b	Delete the first sentence of the last paragraph of this subsection.
430*	707.03.D.7.b	Change the title of the Table 707-4 to read: "Minimum Bolt Tension for ASTM F 3125 Grade A 325"
430	707.03.D.7.b	Change "104,000" to "103,000" in the last row under the column titled Minimum Bolt Tension.
431	707.03.D.7.c	Add the following sentence to the end of the first paragraph of this subsection: "If using impact wrenches, provide wrenches sufficient to tighten each bolt in approximately 10 seconds."
431*	707.03.D.7.c	Change the first sentence of the second paragraph to read: "Do not reuse ASTM F 3125 Grade A 325 bolts and nuts.."
434	707.04.A	Change the first sentence of the first paragraph of this subsection to read: "The Engineer will measure structural steel by the calculated weight of metal in the finished structure, excluding filler metal in welding, as shown on the shop drawings or working drawings."
438	708.03.A.2	Change the title of the subsection from "Shop Plans to read "Shop Drawings". Change the first sentence to read: "Submit shop drawings in accordance with subsection 104.02." Change the fourth sentence to read:

Page	Subsection	Errata
		"Do not start production until the Engineer approves the shop drawings."
441*	708.03.A.11	Change the last sentence of the first paragraph to read "Cure concrete at temperatures from 70 °F to 150 °F until concrete attains the release strength shown on the shop drawings".
441	708.03.A.11	Change the fourth sentence of the fourth paragraph to read "Do not exceed a maximum concrete temperature of 150 °F during the curing cycle."
458	711.03.A	Change the first sentence in the first paragraph to read: "Shop drawings for structural steel and pipe railings are not required."
460	711.04.A	Change the second sentence of the first paragraph to read: "The unit price for Bridge Barrier Railing includes the cost of placing steel reinforcement, providing and placing concrete, constructing joints, and forming, finishing, curing and protecting the concrete."
461	711.04.F	The title of this subsection should read " Reflective Marker, Permanent Barrier. "
467	712.03.C	Add the following to the end of the third paragraph of the subsection: "Notify the Engineer of any saw cuts in the top flange. Saw cuts equal to or less than 1/32 inch deep in steel beams must be repaired by grinding, to a surface roughness no greater than 125 micro-inches per inch rms, and tapering to the original surface using a 1:10 slope. Saw cuts in excess of 1/32 inch deep in steel beams require a welded repair to be submitted to the Engineer for approval. Weld in accordance with subsection 707.03.D.8 and provide adequate notice to allow the Engineer to witness the repair work. Inspect and test all saw cut repairs (including grinding repairs) using ultrasonic testing in accordance with 707.03.D.8.c at no additional cost to the Department."
471	712.03.J	Add the following to the end of the second paragraph of the subsection: "Select adhesive anchor systems from the Qualified Products List."
471	712.03.J.1	Delete the first paragraph in this subsection and replace it with the following: "Propose complete details of drilling, cleaning, and bonding systems for anchoring reinforcement and submit for the Engineer's approval before use. The minimum embedment depth must be nine times the anchor diameter for threaded rod or bolt and twelve times the anchor diameter for reinforcing bar. Propose a drilling method that does not cut or damage existing reinforcing steel. Prepare at least three proof tests per anchor diameter and type in the same orientation in which they will be installed on the existing structure, on a separate concrete block, in the presence of the Engineer. The Engineer will proof test the proposed systems. The Engineer will base approval of the anchoring system on the following criteria:"
471	712.03.J.2	Change the third sentence of the first paragraph to read:

Page	Subsection	Errata
		"Use a tension testing device for unconfined testing, in accordance with ASTM E 488."
473	712.03.L.2	Change the first sentence in the second paragraph of this subsection to read: "If using epoxy coated steel reinforcement, epoxy coat mechanical reinforcement splices in accordance with ASTM A 775."
473	712.03.L.3	Delete the existing first sentence in the first paragraph.
473	712.03.L.3	Change the third sentence of the first paragraph to read "Provide two test splices on the largest bar size."
473*	712.03.L.3	Change the sentence beginning "Demonstrate to the.... to read: "Demonstrate to the Engineer that splices have a tensile strength of 125 percent of the bar yield strength and high strength splices have a tensile strength of 150 percent of the bar yield strength."
488	713.02	Add the following as subsection 713.02.C: "C. Structural Steel for Retrofitting and Welded Repairs. Structural steel material used for retrofitting and welded repairs of primary members as defined in subsection 707.01.B must meet longitudinal Charpy V-Notch impact test requirements."
501	715.02	Add the following material reference above the two existing items: "Sealant for Perimeter of Beam Plates.....713"
508	715.03.D.1	Add the following sentence after the second paragraph of the subsection: "Apply sealant for perimeter of beam plates in accordance with subsection 713.03.F."
515	716.03.A	Delete the second paragraph of this subsection in its entirety. Change the last sentence of the last paragraph of this subsection to read: "Provide a primer dry film thickness for the top flange between 4 mils and 10 mils."
519	716.04	Change the second sentence of the first paragraph of this subsection to read: "The unit price for Field Repair of Damaged Coating (Structure No.) includes the costs of making field repairs to the shop applied coating system; prime coat surfaces and exposed surfaces of bolts, nuts, and washers; and repairing stenciling."
521	717.04.B	This subsection should read "The unit price for Drain Casting Assembly includes the cost of providing and installing the downspout and, if necessary, the lower bracket to the drain casting."

Page	Subsection	Errata
522	718.02	Change the section number "906" in the third material in the list to read "919."
533	718.04	Delete the following pay item from the list: Temp Casing.....Foot
533	718.04.B.2	Delete this subsection in its entirety.
533	718.04.B.3	Renumber this subsection as follows: "2. Permanent Casing. "
540	802.04	Change "Non reinf" in the last pay item of the list with "Nonreinf".
545*	803.04.E	Change the second sentence of the second paragraph to read: "The unit price for Railing for Steps includes the cost of providing, fabricating, installing, and grouting the railing."
560	807.04	Delete the following pay item from the list: Guardrail Buffered EndEach
560	807.04.B	Change the fifth paragraph of this subsection to read: "The Engineer will measure Guardrail Salv and Guardrail, Mult, Salv along the face of the rail (one face for multiple beams), including terminals and end shoes."
567	808.04.C	Change the first paragraph of this subsection to read: "The Department will not pay separately for protective fence required in accordance with subsection 104.07."
569	809.04.A	Change the first sentence to read: "The unit price for Field Office, CI __ includes the cost of setup, providing access, grading, maintaining, plowing snow, and utility hook-up charges."
570	809.04.B	Delete the existing second and third sentences in the first paragraph and replace them with the following: "The unit price for Field Office, Utility Fees includes the cost of monthly usage fees for electricity, gas, telephone service and charges, fuel for the stove, monthly water and sanitary service."
570	809.04.B	Change the existing fourth sentence in the first paragraph to read: "The Department will reimburse the Contractor for monthly usage fees for electricity, gas, telephone, water and sanitary charges incurred by the Department."
575	810.03.K	Change the subsection to read "K. Drilled Piles for Cantilever and Truss Foundations. Construct drilled piles for cantilever and truss foundations in accordance with section 718."

Page	Subsection	Errata
578	810.03.N.2	Add the following sentence after the first sentence of the second paragraph on this page: "Mark each nut and bolt to reference the required rotation."
584	810.04	Delete the last pay item in the list: Truss Fdn Anchor Bolts, Replace.....Each
585	810.04.B.1	Change the second paragraph to read: "The unit prices for Fdn, Truss Sign Structure Type __, __ inch Dia, Cased and Fdn, Cantilever Sign Structure Type __, __ inch Dia, Cased include the cost of concrete, slurry, steel reinforcement, permanent casings, anchor bolts, excavation, and disposal of excavated material."
585	810.04.B.2	Change the second sentence of the first paragraph to read: "The unit prices for Fdn, Truss Sign Structure Type __, __ inch Dia, Uncased and Fdn, Cantilever Sign Structure Type __, __ inch Dia, Uncased include the cost of concrete, slurry, steel reinforcement, temporary casings, anchor bolts, excavation, and disposal of excavated material."
596	811.03.G	Delete this subsection in its entirety.
597*	811.03.H	Rename this subsection as follows: "G. Raised Pavement Marker (RPM) Removal. "
597*	811.04	Change "Crosshatching" in the last pay item of the list on this page to "Cross Hatching".
598*	811.04	Delete the following pay items from the list: Pavt Mrkg, (material), 4 inch, SRSM, (color).....Foot Pavt Mrkg, (material), 4 inch, SRSM, 2 nd Application, (color).....Foot Add the following pay items to the list: "Pavt Mrkg, Polyurea, (legend).....Each Pavt Mrkg, Polyurea, (symbol).....Each" Change the sixth item down the list to read: "Pavt Mrkg, Polyurea, __ inch, Cross Hatching, (color)" Change the eleventh item down the list to read: "Rem Curing Compound, for Longit Mrkg, __ inch.....Foot"
599	811.04.B	Delete this subsection in its entirety.
599	811.04	Rename the following subsections as follows: "B. Call Back. C. Pavement Marking Removal. D. Material Deficiency. "

Page	Subsection	Errata
602	812.03.D	Change the first sentence to read "Provide and maintain traffic control devices meeting the requirements in the ATSSA Quality Guidelines for Work Zone Traffic Control Devices and Features."
603	812.03.D.1	The last sentence on this page should read "Lay the sign behind the guardrail, with the uprights pointing downstream from the traffic, and place the support stands and ballasts close to the guardrail."
604	812.03.D.2	The first sentence of the fourth paragraph should read "Do not use burlap or similar material to cover Department or Local Government owned signs."
604	812.03.D.5	The fifth sentence of the first paragraph should read "Do not mix drums and cones within a traffic channeling sequence."
605	812.03.D.6.b	Change the first sentence of the first paragraph to read: "The Department will allow the nighttime use of 42-inch channelizing devices, in the tangent area only, on CPM and pavement marking of any duration where the use of plastic drums restricts proposed lane widths to less than 11 feet, including shy distance."
605	812.03.D.7	Add the following sentence after the first sentence of the first paragraph: "Place a shoulder closure taper in advance of the lighted arrows placed on the shoulders."
607	812.03.D.9	Delete the second paragraph of this subsection and replace with the following: "Link sections together to fully engage the connection between sections. Maintain the barrier with end-attachments engaged and within 2 inches of the alignment shown on the plans."
608	812.03.D.10.b	Delete the second sentence of the second paragraph of this subsection beginning with "Install sand module attenuators..."
608	812.03.D.10.b	Add the following sentence after the second paragraph of this subsection: "Install impact attenuation devices as shown on the plans, as directed by the Engineer, or both."
609	812.03.D.10.e	Delete the second paragraph of this subsection.
612	812.03.D.13	Delete the third paragraph of this subsection and replace it with the following: "Perform work on signals in accordance with the contract and to the requirements of NEMA TS-5 standard for those items not identified in the contract."
613*	812.03.D.14.a.iii	Change the sentence in this subsection to read "Place a terminal end shoe, in accordance with Standard Plan R-66-Series, and of appropriate type based on existing guardrail, on both blunt guardrail ends."

Page	Subsection	Errata
615	812.03.F	The second sentence of the second paragraph of this subsection should read: "The Contractor may use a Type R temporary pavement marking cover, per subsection 812.03.D.12 when authorized by the Engineer."
616	812.03.F.2	The last sentence of the first paragraph should read: "If the removal equipment cannot collect all removal debris, operate a self-propelled sweeper capable of continuously vacuuming up the removal debris immediately behind the removal equipment."
617	812.03.G.3	The first sentence of the second paragraph should read: "Sweep the shoulder and remove debris prior to placing traffic on the shoulder and throughout the time the shoulder is used to maintain traffic."
617	812.03.G.4.a	Delete "48 inch by 48 inch" from the first sentence of this subsection.
618*	812.03.G.7	The first sentence of the first paragraph should read: "Clean barrier reflectors, plastic drums, 42 inch channelizing devices, tubular markers, signs, barricades, and attached lights in operation on the project to ensure they meet required luminosity."
619	812.03.G.8	The second sentence of the third paragraph from the end of the subsection should read: "Illuminate traffic regulator stations at night per subsection 812.03.H."
621	812.03.I.6	Delete "48 inch by 48 inch" from the second sentence of this subsection.
622*	812.03.J	The second paragraph should read "Apply one 2-inch wide horizontal stripe of red and white conspicuity tape along at least 50 percent of each side of, and across the full width of the rear of the vehicle or equipment."
622	812.04	Change the second item down the list to read: "Traf Regulator Control" Change the sixth item down the list to read: "Sign Cover, Type I"
626	812.04.I	Change the reference "812.04.E" in the first sentence to "812.04.D".
628	812.04.M.4	Add the following as the first sentence of this subsection: "The Engineer will not measure a temporary barrier ending move as Conc Barrier Ending, Temp, Relocated if it involves work defined in subsection 812.04.M.3."
629	812.04.N.1	Change the reference "811.04.D" in the second paragraph of this subsection to read "811.04.C".
630	812.04.S	Change the first sentence to read: "The Department will not make additional payments for traffic regulating, signing, arrow boards, and lighting systems for traffic regulator stations operated at night due to a temporary PTS system failure."

Page	Subsection	Errata
634	813.03.C.3	Change the reference "903.07.A" in the paragraph of this subsection to read "907.07.B".
638	814.03.D	Change the second sentence to read: "Place the HMA mixture on the prepared base to a thickness of at least 2 inches, and to at least 220 pounds per square yard."
646	815.04	Change the first, third and fourth pay items in the list to read: "Site Preparation, Max (dollar) Lump Sum Watering and Cultivating, First Season, Min (dollar)..... Lump Sum Watering and Cultivating, Second Season, Min (dollar) Lump Sum"
646	815.04.C.1	Change the following pay item reading: "Watering and Cultivating, First Season, Min. (dollar)" to read "Watering and Cultivating, First Season, Min (dollar)" at two locations throughout the subsection.
646	815.04.C.1.b	Delete this subsection in its entirety.
646	815.04.C.1.c	Rename this subsection to read: "b. Removal and disposal of unacceptable plants."
646	815.04.C.2	Change the following pay item reading: "Watering and Cultivating, Second Season, Min. (dollar)" to read "Watering and Cultivating, Second Season, Min (dollar)" at three locations throughout the subsection.
647	815.04.C.2	Change the last paragraph of this subsection to read: "For each unacceptable plant identified, the Engineer will calculate a 50 percent reduction in the unit price for the relevant (Botanical Name) pay item, and will process a negative assessment for each unacceptable plant for that amount."
650	816.03.B	Delete the first paragraph of this subsection and replace with the following: "Conduct soil tests when called for in the contract or when directed by the Engineer. Provide soils tests results to the Engineer when testing is required. Provide and place fertilizer as indicated below and as indicated in the soils tests, if required."
650	816.03.B.1	Change the sentence to read: "For Class A fertilizer, evenly apply 176 pounds of chemical fertilizer nutrient per acre on a prepared seed bed."
650	816.03.B.2	Change the sentence to read: "For Class B fertilizer, evenly apply 120 pounds of chemical fertilizer nutrient per acre on a prepared seed bed."
650*	816.03.B.3	Change the sentence to read: "For Class C fertilizer, evenly apply 80 pounds of chemical fertilizer nutrient per acre on established turf."

Page	Subsection	Errata
663*	819.01	<p>Delete the first paragraph in the subsection and replace it with the following: “This work consists of providing operating electrical and lighting units; removing, salvaging, or disposing of existing electrical and lighting components; excavating, backfilling, restoring the site in accordance with section 816; and disposing of waste excavated materials. Complete this work in accordance with this section, section 820, and the contract and to the requirements of the NEC, the National Electrical Safety Code, and the MDLARA for those items not identified in the contract.”</p> <p>Change the third sentence of the second paragraph in this subsection to read: “Contact the MDLARA for electrical service inspection and pay the applicable fees.”</p>
671	819.03.F.1	<p>Change the paragraph to read: “Install light standard foundations as shown on the plans and the standard plans, as applicable.”</p>
673	819.03.G.4.b	<p>Change the last sentence of the first paragraph to read: "Tighten the anchor bolts to a snug tight condition as described in the third paragraph of subsection 810.03.N.2 ensuring the lock washer is completely compressed."</p>
673	819.03.G.4.b	<p>Delete the first two sentences of the second paragraph and replace with the following: "Tighten bolts connecting the pole to the frangible base to a snug tight condition. Snug tight is the tightness attained by a few impacts of an impact wrench, or the full effort of a person using an ordinary spud wrench. The lock washers must be fully compressed."</p>
678	819.04	<p>Change the ninth pay item in the list to read: “DB Cable, 600V, 1/C# (size)..... Foot”</p>
678*	819.04	<p>Delete the last item in the list on this page reading: “DB Cable, in Conduit, 600 Volt, (number) 1/C# (size) Foot”</p>
679	819.04	<p>Change the first pay item in the list to read: “DB Cable, in Conduit, 600V, 1/C# (size)..... Foot”</p>
679	819.04	<p>Change the sixth pay item in the list to read: “Cable, P.J., 600V, 1, (size) Foot”</p>
679	819.04	<p>Change the second pay item from the bottom of the list to read: “Conc Pole, Fit Up, (type) Each”</p>
680	819.04	<p>Change the first paragraph to read: “Unless otherwise required, the unit prices for the pay items listed in this subsection include the cost of excavation, granular material, backfill,</p>

Page	Subsection	Errata
		and disposal of waste excavated material. If the contract does not include pay items for restoring the site in kind in accordance with section 816, the Department will consider the cost of restoration included in the pay items listed in this subsection."
680	819.04.A	Add the following paragraph after the first paragraph of the subsection. "The unit prices for Conduit, Rem include the cost of removing the type, number, and size of conduit shown on the plans." Change the third paragraph of the subsection to read: "The unit prices for Conduit, (type), __ inch and Conduit, DB, (number), __ inch include the cost of installing the type, number, and size of conduit shown on the plans, and installing marking tape."
681	819.04.B	Change the last paragraph of the subsection to read: "The unit price for DB Cable, in Conduit, Rem includes the cost of removing all cables from the existing conduit measured per lineal foot of conduit."
681	819.04.C	Change the first paragraph of the subsection to read: "The unit prices for Cable, Rem and Cable, (type), Rem include the cost of dead ending, circuit cutting, installing guying, work required to leave circuits operable, and disposing of the removed cables, wire, hardware, and other appurtenances."
681	819.04.D	Change the first paragraph of the subsection to read: "The unit price for Cable, Pole, (type), Disman includes the cost of dismantling and off-site disposal of the following:"
685	820.01.D	Change the sentence to read: "Excavate, backfill, restore the site in kind in accordance with section 816, and dispose of excess or unsuitable material;"
688	820.03.C	Change the seventh paragraph of this subsection to read: "Tighten top anchor bolt nuts, snug, in accordance with the first four paragraphs of subsection 810.03.N.2, except beeswax will not be required."
696	820.04	Add the following pay items to the list: "Pedestal, Pushbutton, Alum.....Each Pedestal, Pushbutton, Rem.....Each"
697	820.04.A.2	Change the sentence to read: "If the contract does not include pay items for restoring the site in kind in accordance with section 816, the Department will consider the cost of restoration included in the pay items listed in this subsection."
698	820.04.B	Delete the second paragraph of this subsection found on this page.
698	820.04.C	Change " Fdns " to read " Fdn " in four instances in this subsection.

Page	Subsection	Errata
701	820.04.J.3	Change the sentence to read: "Installing wires in the saw slots and to the handholes;"
701.	820.04.J	Add the following as a new subsection: "7. A 3/4 inch minimum flexible conduit (non-metallic and rated for underground use) from the pavement to the handhole."
706	821.01.B	Change the website address listed after the second paragraph on this page to read: <u>"http://www.ngs.noaa.gov/heightmod/GuidelinesPublications.shtml"</u>
711	822.03.B	Change the second paragraph to read: "If corrugations are required on concrete shoulders and the method of installation is not shown on the plans or directed by the Engineer, construct corrugations by grinding, or cutting."
718*	823.03.U	Change "MDNRE" to "MDEGLE" in four instances in this subsection.
720	823.04	Change the pay item seventh from the bottom of the list to read: "Water Shutoff, Adj, Temp, Case ___"
730	824.03.Q	Change the third sentence of the fourth paragraph to read: "Ensure placement of monumentation in accordance with section 821."
730	824.03.Q	Change the first sentence of the last paragraph to read: "The Department will not pay for work dependent on lost or destroyed stakes until the Contractor replaces the stakes."
732	824.04	Change the first sentence of the first paragraph following the list of pay items to read: "If the Engineer determines the Contractor will perform staking as extra work, the Department will pay for staking in accordance with section 103."
733	824.04	Change the left column header in Table 824-2 to read: "Percent of Original Contract Amount Earned"
739	902.02	Change the last aggregate testing description to read: "Determining Specific Gravity and Absorption of Fine Aggregates.....MTM 321"
742	902.03.C.1.a	Change the sentence to read: "Coarse aggregate includes all aggregate particles greater than or retained on the 3/4-inch sieve."
742	902.03.C.2.a	Change the sentence to read: "Intermediate aggregate includes all aggregate particles passing the 3/4-inch sieve through those retained on the No. 4 sieve."

Page	Subsection	Errata
742	902.03.C.2.b.iii	Change the sentence to read as follows: "Maximum Loss by Washing per MTM 108 of 3.0 percent".
744	902.07	Delete the fourth paragraph of the subsection and replace it with the following: "The Engineer will only allow the use of granular material produced from crushed portland cement concrete for embankment and as trench backfill for non-metallic culvert and sewer pipes without associated underdrains. However, granular material produced from crushed portland cement concrete is not permitted as swamp backfill, nor within the top 3 feet below subgrade regardless of the application.
746*	902.11	Change the Item of Work by Section Number column in Table 902-1 for the 6AA row to read: "406, 601, 602, 706, 708, 806". Change the Item of Work by Section Number column in Table 902-1 for the 6A row to read: "206, 401, 402, 406, 601, 602, 603, 706, 806". Change the Item of Work by Section Number column in Table 902-1 for the 34R row to read: "401, 404, 406".
751*	902.11	Replace Table 902-6 with the Table 902-6 below.
751	Table 902-7	Under the Material column in the fourth row change the "FA2" to read "2FA".
751	Table 902-7	Under the Material column in the fifth row change the "FA3" to read "3FA".
752	Table 902-8	Under the Material column in the fourth row change the "FA2" to read "2FA".
752	Table 902-8	Under the Material column in the fifth row change the "FA3" to read "3FA".
761	Table 904-2	Delete the footnote f and any other reference to footnote f from the table.
767	905.03	Change the first sentence of the first paragraph to read: "Deformed bars, must meet the requirements of ASTM A 706, ASTM A 615, or ASTM A 996 (Type R or Type A only) for Grade 60 steel bars, unless otherwise required".
767*	905.03	Change the first sentence of the second paragraph to read: "Unless otherwise specified, spiral reinforcement must meet the requirements of plain or deformed Grade 40 steel bars of ASTM A 615, ASTM A 996 (Type A), or the requirements of cold-drawn wire of ASTM A 1064".
767	905.03	Change the first sentence of the third paragraph to read: "Bar reinforcement for prestressed concrete beams must meet the requirements of ASTM A 996 (Type R) for Grade 60 steel bars, except

Page	Subsection	Errata
		the Engineer will allow bar reinforcement that meets the requirements of ASTM A 615 or ASTM A 996 (Type A) for Grade 40 steel bars for stirrups in prestressed concrete beams”.
768	905.03.C	Change the first sentence in the subsection to read: "Epoxy coated steel reinforcement, if required, must be coated in accordance with ASTM A 775, with the following exceptions and additions."
768	905.03.C.3	Change the first sentence of this subsection to read: "Include written certification that the coated reinforcing bars were cleaned, coated, and tested in accordance with ASTM A 775 with the coating applicator."
768	905.05	Change the first sentence of the first paragraph to read: "Deformed steel bars must meet the requirements of ASTM A 706 or the requirements for Grade 40, Grade 50, or Grade 60 of ASTM A 615 or ASTM A 996 (Type R or Type A only)".
768	905.06	Delete this subsection in its entirety and replace it with the following: "Deformed wire fabric for prestressed concrete and fabric for concrete pavement reinforcement must meet the requirements of ASTM A 1064 and fabricated as required."
772*	906.07	Change the first paragraph to read: "High-strength bolt fasteners for structural joints must meet the requirements of ASTM F 3125 Grade A 325 Type 1 bolts. High-strength nuts for structural joints must meet the requirements of ASTM A 563 Grade DH or AASHTO M 292 Grade 2H. High-strength washers for structural joints must meet the requirements of ASTM F 436 Type 1 for circular, beveled, clipped circular, and clipped beveled washers." Change the second sentence of the second paragraph of this subsection to read: "Galvanized nuts must be tapped oversize in accordance with ASTM A 563 and meet Supplementary Requirements S1, Lubricant and Rotational Capacity Test for Coated Nuts and S2, Lubricant Dye."
777*	907.03.D.2.a	Change the first sentence of the second paragraph to read: "Angle sections must be nominal 2½ inch by 2½ inch by ¼ inch."
777*	907.03.D.2.b	Change the first sentence of the first paragraph to read: "Angle section braces must be nominal 1¾ inch by 1¾ inch by ¼ inch or nominal 2 inch by 2 inch ³ / ₁₆ inch."
782	908.04	Change the first sentence of the first paragraph of this subsection to read: "Steel castings for steel construction must meet the requirements of ASTM A 148 for Grade 60/90 carbon steel castings, as shown on the plans, unless the Engineer approves an alternate in writing."

Page	Subsection	Errata
784*	908.09.C	<p>Change this subsection to read: "C. Hardware. Railing anchor studs must meet the requirements of ASTM A 449 Type 1. Heavy hex nuts must meet the requirements of ASTM A 563. Bolts, used as rail fasteners, must meet the requirements of ASTM F 3125 Grade A 325, Type 1. Where called for, round head bolts must meet the requirements of ASTM A 449 Type 1. The material for the railing hand hole screws must meet the requirements of ASTM A 276, Type 304. All nuts must meet the requirements of ASTM A 563 Grade DH or AASHTO M 292 Grade 2H. All flat washers must meet the requirements of ASTM F 436. Lock washers must be steel, regular, helical spring washers meeting the requirements of ANSI B18.21.1 - 1972. Bolts, nuts, washers and other hardware must be hot-dip galvanized in accordance with AASHTO M 232. Galvanized nuts must be tapped oversize in accordance with ASTM A 563, and meet Supplementary Requirements S1, Lubricant and Rotational Capacity Test for Coated Nuts, and S2, Lubricant Dye."</p>
784	908.11.A	<p>Change the first sentence of the first paragraph to read: "Steel beam sections, backup elements, terminal end shoes, and special end shoes must meet the requirements of AASHTO M 180, for Class A guardrail."</p>
785*	908.11.B	<p>Change the second paragraph to read: "Bolts, nuts, and round washers for guardrail, other than at bridge barrier railings, must meet the requirements of ASTM A 307 (Grade A), ASTM A 563 (Grade A with Supplementary Requirements S1 of ASTM A 563), and ASTM F 436, respectively."</p> <p>Change the third paragraph to read: "Washers, other than round washers, for guardrail must meet the requirements for circular washers in ASTM F 436 except that the dimensions must be as shown on the plans."</p> <p>Change the fifth paragraph to read: "Bolts, nuts, and washers for connections at bridge barrier railings must conform to ASTM F 3125 Grade A 325 Type 1 galvanized high-strength structural bolts with suitable nuts and hardened washers."</p>
787	908.14.B	<p>Add the following sentence to the end of the third paragraph of this subsection: "Exposed threaded ends of anchor bolts must be galvanized a minimum of 20 inches."</p> <p>Change the sixth paragraph in this subsection to read: "Provide washers meeting the requirements of ASTM F 436 for circular washers."</p>
787	908.14.B	<p>Change the second sentence of the fourth paragraph to read "After coating, the maximum limit of pitch and major diameter for bolts with a</p>

Page	Subsection	Errata
		diameter no greater than 1 inch may exceed the Class 2A limit by no greater than 0.021 inch, and by no greater than 0.031 inch for bolts greater than 1 inch in diameter”.
787*	908.14.C	Change the first paragraph to read "Provide either four or six high strength anchor bolts per the contract plans, meeting the mechanical requirements of ASTM F 1554, for Grade 105, with each standard. Anchor bolts for traffic signal strain poles must meet the requirements of subsection 908.14.B with the following exceptions and additions:"
789	909.03	Change the second sentence of the second paragraph to read: "As an alternative to the AASHTO M 36 requirements for metal pipe, the Contractor may use gasket material meeting the low temperature flexibility and elevated temperature flow test requirements of ASTM C 990, excluding the requirements for softening point, flashpoint and fire point."
793	909.06	Change the first sentence of the second paragraph of this subsection to read: "Provide Corrugated Polyvinyl Chloride Pipe (CPV) and required fittings meeting the requirements of AASHTO M 304."
793*	909.05.D	Change the second sentence of the paragraph to read "Provide a continuous welded joint to create a watertight casing that is capable of withstanding handling and installation stresses. Perform field welding by the SMAW process using E7018 electrodes."
794*	909.08.A	Change the first sentence to read: "Provide bridge deck downspouts of PE pipe meeting the requirements of ASTM F 714, PE 4710, DR 26."
804	Table 909-9	In the note area at the bottom of the table change the designation of the second note from "c." to "b."
811	910.04	Add the following sentence to the end of this subsection: "Fabricate silt fence according to subsection 916.02."
814	Table 911-1	In the 4 th row of the 5 rows in the table change the Property listed as "Total Organic Content (TOC)" to read "Total Organic Carbon (TOC)".
829*	912.08.K	Replace Table 912-10 with the Table 912-10 below.
833*	913.03.B	Change the first sentence of the first paragraph to read: "Clay brick, to construct manholes, catch basins, and similar structures, must meet the requirements of ASTM C 32, for Grade MS."
837*	914.04	Add the following as subsection 914.04.C: "C. Lubricant-Adhesive for Neoprene Joint Seals. The lubricant-adhesive must be a single-component moisture-curing polyurethane and aromatic hydrocarbon solvent mixture meeting ASTM D 2835, Type

Page	Subsection	Errata
		I. Ship in containers plainly marked with the lot or batch number of the material and date of manufacture. Store at temperatures between 58 and 80°F. Do not exceed 12 months shelf-life prior to use."
840	914.08	Change the first sentence of the second paragraph to read: "Straight tie bars for end-of-pour joints must consist of bars of the diameter and length shown on the plans meeting the requirements of ASTM A 615, ASTM A 706, or ASTM A 996 (Type R or Type A only)".
840*	914.09.A	Change the first sentence of the first paragraph to read: "Straight tie bars for longitudinal pavement joints must consist of bars of the diameter and length shown on the plans meeting the requirements of ASTM A 615, ASTM A 706, or ASTM A 996 (Type R or Type A only)".
840	914.09.B	Change the first sentence of the first paragraph to read: "Bent tie bars for bulkhead joints must consist of bars of the diameter and length shown on the plans."
841*	914.13	In the first sentence of this subsection change "ASTM D 1248, for Type III, Class B" to read "ASTM D 4976, Group 2, Class 4, Grade 4".
844	916.01.A	Change the first sentence to read: "Cobblestone must consist of rounded or semi-rounded rock fragments with an average dimension from 3 inches to 10 inches."
845	916.01.D.1	Change the second sentence to read: "Checkdams for ditch grades 2 percent or greater must be constructed using cobblestone or broken concrete ranging from 3 inches to 10 inches in size."
851*	917.10.B.1	Delete the paragraph and replace it with the following: "1. Class A. Provide and apply Class A chemical nutrient fertilizer either according to MSU Soil Testing Lab Recommendations for Phosphorus Applications to Turfgrass, except the maximum single application rate of nutrient will be 48 pounds per acre, when soil tests are required or as indicated in subsections 917.10.B.1.a and 917.10.B.1.b."
851	917.10.B.1	Add the MSU Soil Testing Lab Recommendations for Phosphorus Applications to Turfgrass, found below, after the first paragraph of this subsection.
853	917.15.B.1	Change the second sentence of the subsection to read: "The net must meet the requirements of subsection 917.15.D and be capable of reinforcing the blanket to prevent damage during shipping, handling, and installation."
857	918.01	Add the following two paragraphs following the first paragraph of this subsection: "Wall thickness and outside diameter dimensions must conform to ASTM D 1785 for smooth-wall schedule 40 and 80 PVC conduit

Page	Subsection	Errata
		material. The Department will allow no more than 3 percent deviation from the minimum wall thickness specified.
		Wall thickness range must be within 12 percent in accordance with ASTM D 3035 for smooth-wall coilable schedule 40 and 80 PE conduit.”
858	918.01.E	Delete the first three sentences of the second paragraph shown on page 858.
863	918.06.F.1	Delete the third paragraph in this subsection in its entirety and replace it with the following: "Provide smooth or deformed welded wire fabric in accordance with ASTM A 1064."
864	918.07.C	Change the first sentence of the first paragraph to read: "Provide anchor bolts, nuts, and washers meeting the requirements of subsection 908.14.A and subsection 908.14.B."
864	918.07.C	Delete the second sentence of the second paragraph.
864	918.07.C	Change the third sentence to read: "Provide anchor bolts threaded 4 inches beyond the anchor bolt projection shown on the plans."
867	918.08.C	Change the last sentence of the first paragraph on this page to read: "Galvanize bolts, nuts, washers, and lock washers as specified in subsection 908.14.B."
867	918.08.C	Change the last sentence of the subsection to read: "Provide each frangible base with manufacturer access covers as shown on the plans."
867*	918.08.D	Delete this subsection in its entirety and replace with the following: "Provide galvanized anchor bolts, studs, nuts, couplings, and washers in accordance with subsection 908.14."
879	918.10.J	Change the third sentence of the second paragraph of this subsection to read: "Provide anchor bolts and associated nuts, washers, and hardware meeting the requirements of subsection 908.14."
887	919.06	Change the second paragraph to read: "Shims must be fabricated from brass shim stock or brass strip meeting the requirements of ASTM B 36, for copper alloy UNS No. C26000, half-hard rolled temper, or fabricated from galvanized sheeting meeting the requirements of ASTM A 653, for Coating Designation G 90."
887	919.07.C	Change the sentence to read:

Page	Subsection	Errata						
		“Galvanized high-strength steel bolts, nuts, and washers for connecting arm connection flanges must meet the requirements of subsection 906.07.”						
903	921.03.D	Delete the last three sentences of the first paragraph of this subsection.						
914	921.05.D	Change the first sentence of this subsection to read: "Provide anchor bolts meeting the requirements of subsection 908.14.C, including elongation and reduction of area requirements."						
916	921.07	Change the first sentence of the first paragraph to read: "Provide LED case signs internally illuminated by LEDs and changeable message case signs internally illuminated with LED light sources."						
936	922.04.B	In the first sentence of the first paragraph change the "R-52" to "R-126".						
936	922.04.B	Add the following to the end of the first paragraph: “Hardware used to connect the end section to the barrier must meet the requirements of NCHRP 350 or MASH (Test Level 3 or higher).”						
936	922.04.B	In the first sentence of the second paragraph delete "R-52".						
936	922.04.B	Change the fourth paragraph of this subsection to read as follows: For all endings requiring impact attenuators provide a NCHRP-350 Test Level 3 or MASH Test Level 3 approved impact attenuation system, unless otherwise approved by the Engineer.						
952	Pay Item Index	Change the following pay items to read: <table border="0"> <tr> <td>“Conc Barrier, Rem</td> <td>123</td> <td>204”</td> </tr> <tr> <td>“Conc Pole, Fit Up, (type)</td> <td>679</td> <td>819”</td> </tr> </table>	“Conc Barrier, Rem	123	204”	“Conc Pole, Fit Up, (type)	679	819”
“Conc Barrier, Rem	123	204”						
“Conc Pole, Fit Up, (type)	679	819”						
953*	Pay Item Index	Delete the following pay item reading: “DB Cable, in Conduit, 600 Volt, (number) 1/C# (size)678 819”						
957	Pay Item Index	Delete the following pay item from the list: Guardrail Buffered End560 807						
960	Pay Item Index	Change the following pay item to read: “Mobilization, Max (dollar)107 150”						
961	Pay item Index	Delete the following pay items from the list: <table border="0"> <tr> <td>Pavt Mrkg, (material), 4 inch, SRSM, (color).....</td> <td>598.....</td> <td>811</td> </tr> <tr> <td>Pavt Mrkg, (material), 4 inch, SRSM, 2nd Application, (color).....</td> <td>598.....</td> <td>811</td> </tr> </table>	Pavt Mrkg, (material), 4 inch, SRSM, (color).....	598.....	811	Pavt Mrkg, (material), 4 inch, SRSM, 2 nd Application, (color).....	598.....	811
Pavt Mrkg, (material), 4 inch, SRSM, (color).....	598.....	811						
Pavt Mrkg, (material), 4 inch, SRSM, 2 nd Application, (color).....	598.....	811						
961	Pay Item Index	Change the following pay items in the list to read: Pavt Mrkg, Ovly Cold Plastic, 12 inch, Cross Hatching, (color) Pavt Mrkg, Polyurea, __ inch, Cross Hatching, (color) Add the following pay items to the list:						

Page	Subsection	Errata		
		"Pavt Mrkg, Polyurea, (legend).....	598.....	811
		Pavt Mrkg, Polyurea, (symbol).....	598.....	811
		Pedestal, Pushbutton, Alum.....	696.....	820
		Pedestal, Pushbutton, Rem.....	696.....	820"
962	Pay Item Index	Change the following pay items in the list to read: "Pile Driving Equipment, Furn (Structure No.) Pile, Galv (Structure No.)"		
963	Pay Item Index	Change the following pay item to read: "Rem Curing Compound, for Longit Mrkg, __ inch	598	811"
964	Pay Item Index	Change the following pay item to read: "Sewer, CI __, __ inch, Jacked in Place	200	402"
		"Sign Cover, Type I.....	622	812"
965*	Pay Item Index	Change the following pay item in the list to read: "Steel Casing Pipe, __ inch, Tr Det __ Site Preparation, Max (dollar)	646	815"
966	Pay Item Index	Change the following pay item to read: "Structures, Rem (Structure No.).....	123	204"
966	Pay Item Index	Delete the following pay item form the list; Temp Casing.....	533.....	718
967*	Pay Item Index	Delete the following pay item from the list; Truss Fdn Anchor Bolts, Replace.....	584.....	810
967	Pay Item Index	Change the following pay item in the list to read: "Traf Regulator Control"		
968*	Pay item Index	Change the following pay item in the list to read: "Water Shutoff, Adj, Temp, Case __ Watering and Cultivating, First Season, Min (dollar).....	646	815
		Watering and Cultivating, Second Season, Min (dollar)	646	815"
993	General Index	Change "Shop Plans (see Plans and Working Drawings)" to read "Shop Drawings (see Plans and Working Drawings)".		

Table 701-1 Concrete Structure Mixtures												
Concrete Grade (e,h)	Section Number Reference (i)	Cement Content per cyd (b,c)		Type A, D or no Admixture	Type MR, F, or G Admixtures (g)			Minimum Strength of Concrete (f)				
		lb	sack		Before Admixture	After Admixture (Type MR)	After Admixture (Type F or G)	Flexural (psi)				
								7 Day	14 Day	28 Day (Class Design Strength)	7 Day	14 Day
S1	706, 711, 712	658 (d)	7.0	0 - 3	0 - 6	0 - 7	625	700	725	3,200	4,000	4,500
	705	611	6.5	0 - 3	3 - 6	3 - 7	600	650	700	3,000	3,500	4,000
S2 (a)	705, 706	611	6.5	0 - 4	3 - 7	3 - 8	550	600	650	2,600	3,000	3,500
	401, 705, 706, 712, 713, 801, 802, 803, 810	564	6.0	0 - 3	0 - 6	0 - 7	550	600	650	2,600	3,000	3,500
S3	402, 403, 803, 804, 806	526 (d)	5.6	0 - 3	0 - 6	0 - 7	500	550	600	2,200	2,600	3,000
		517	5.5	0 - 3	0 - 6	0 - 7	500	550	600	2,200	2,600	3,000
		489 (d)	5.2									

a. Unless otherwise required, use Coarse Aggregate 6AA or 17A for exposed structural concrete in bridges, retaining walls, and pump stations.

b. Do not place concrete mixtures containing supplemental cementitious materials unless the local average minimum temperature for the next 10 consecutive days is forecast to be above 40 °F. Adjustments to the time required for opening to construction or vehicular traffic may be necessary. Cold weather protection may be required, as described in the quality control plan. The restriction does not apply to Grade S1 concrete in foundation piling below ground level or Grade T concrete in tremie construction.

c. Type III cement is not permitted.

d. Use admixture quantities specified by the Qualified Products Lists to reduce mixing water. Admixture use is required for Grade D, Grade S2, and Grade S3, concrete with a reduced cement content. Use a water-reducing retarding admixture at the required dosage for Grade D concrete to provide the setting retardation required. When the maximum air temperature is not forecast to exceed 60 °F for the day, the Contractor may use a water-reducing admixture or a water-reducing retarding admixture. Ensure Grade D concrete in concrete diaphragms contains a water-reducing admixture, or a water-reducing retarding admixture. For night casting, the Contractor may use a water-reducing admixture in lieu of water-reducing retarding admixture, provided that the concrete can be placed and finished prior to initial set.

e. The mix design basis for bulk volume (dry, loose) of coarse aggregate per unit volume of concrete is 68% for Grade S1, and 70% for Grade D, Grade S2, Grade T, and Grade S3.

f. The Contractor may use flexural strength to determine form removal. Use compressive strength for acceptance in other situations.

g. MR = Mid-range.

h. The Engineer will allow the use of an optimized aggregate gradation as specified in section 604.

i. Section Number Reference:

401	Culverts	711	Bridge Railings	803	Concrete Sidewalk, Sidewalk Ramps, and Steps
402	Storm Sewers	712	Bridge Rehabilitation-Concrete	804	Concrete Barriers and Glare Screens
403	Drainage Structures	713	Bridge Rehabilitation-Steel	806	Bicycle Paths
705	Foundation Piling	801	Concrete Driveways	810	Permanent Traffic Signs and Supports
706	Structural Concrete Construction	802	Concrete Curb, Gutter and Dividers		

An asterisk (*) indicates an entry which has been revised from an earlier version of this Supplemental Specification.

**Table 902-6
Superpave Final Aggregate Blend Physical Requirements**

Est. Traffic (million ESAL)	Mix Type	Percent Crushed Minimum Criteria		Fine Aggregate Angularity Minimum Criteria		% Sand Equivalent Minimum Criteria		Los Angeles Abrasion % Loss Maximum Criteria		% Soft Particles Maximum Criteria (b)		% Flat and Elongated Particles Maximum Criteria (c)	
		Top & Leveling Courses	Base Course	Top & Leveling Courses	Base Course	Top & Leveling Courses	Base Course	Top & Leveling Courses	Base Course	Top & Leveling Courses	Base Course	Top & Leveling Courses	Base Course
< 0.3	LVSP	55/—	—	—	—	40	40	45	45	10	10	—	—
< 0.3	E03	55/—	—	—	—	40	40	45	45	10	10	—	—
≥0.3 -<1.0	E1	65/—	—	40	—	40	40	40	45	10	10	—	—
≥1.0 - < 3	E3	75/—	50/—	40(a)	40(a)	40	40	35	40	5	5	10	10
≥3 - <10	E10	85/80	60/—	45	40	45	45	35	40	5	5	10	10
≥10 - <30	E30	95/90	80/75	45	40	45	45	35	35	3	4.5	10	10
≥30 - <100	E50	100/100	95/90	45	45	50	50	35	35	3	4.5	10	10

(a) For an E3 mixture type that enters the restricted zone as defined in Table 902-5, the minimum is 43. If these criteria are satisfied, acceptance criteria and associated incentive/disincentive or pay adjustment tied to this gradation restricted zone requirement included in contract, do not apply. Otherwise, final gradation blend must be outside of the restricted zone.

(b) Soft particles maximum is the sum of the shale, siltstone, ochre, coal, clay-ironstone and particles that are structurally weak or are non-durable in service.

(c) Maximum by weight with a 1 to 5 aspect ratio.

Note: "85/80" denotes that 85 percent of the coarse aggregate has one fractured face and 80 percent has at least two fractured faces.

An asterisk (*) indicates an entry which has been revised from an earlier version of this Supplemental Specification.

Table 912-10 Minimum Retention Requirements				
Preservative	Minimum Retention, (pcf)			AWPA Standard
	Guardrail Posts	Sign Posts	Blocks	
Pentachlorophenol	0.60	0.50	0.40	A6
CCA, ACZA	0.60	0.50	0.40	A11
ACQ (a)	0.60	Not Allowed	0.40	A11
CA-B (a)	0.31	Not Allowed	0.21	A11
CA-A (a)	0.31	Not Allowed	0.15	A11
Other Waterborne preservatives	AWPA Commodity Specification A, Table 3.0, Use Category 4B	Not Allowed	AWPA Commodity Specification A, Table 3.0, Use Category 4A	A11
a. Non-Metallic washers or spacers are required for timber and lumber treated with ACQ or CA placed in direct contact with aluminum. Do not use with sign posts.				

MSU Soil Testing Lab Recommendations for Phosphorus Applications to Turfgrass
3/8/2012

		Sand based rootzone establishment	Golf greens and tees est. or mature; Kentucky bluegrass or perennial ryegrass athletic fields est. or mature; sand based rootzone mature	Lawns, golf course fairways; establishment or mature	Establishment without soil test
Bray P1, Mehlich 3 Soil Test Value (ppm): pH<7.4	Olsen Soil Test Value (ppm) pH>7.4	Recommendation (lbs. P ₂ O ₅ /1000 ft. ²)	Recommendation (lbs. P ₂ O ₅ /1000 ft. ²)	Recommendation (lbs. P ₂ O ₅ /1000 ft. ²)	Recommendation (lbs. P ₂ O ₅ /1000 ft. ²)
0	0	4.4	3.4	2.5	2.5 lbs. year (Maximum single application of 1.5 lbs.)
2	1.3	4.1	3.1	2.2	
4	2.7	3.9	2.7	1.9	
6	4	3.6	2.4	1.6	
8	5.3	3.4	2.0	1.3	
10	6.7	3.1	1.7	1.0	
12	8	2.8	1.4	0.7	
14	9.3	2.6	1.0	0.4	
16	10.7	2.3	0.7	0.1	
18	12	2.1	0.3	0.0	
20	13.3	1.8	0.0		
22	14.7	1.5			
24	16	1.3			
26	17.3	1.0			
28	18.7	0.8			
30	20	0.5			
32	21.3	0.2			
34	22.7	0.0			

Web resources: www.turf.msu.edu or www.bephosphorusmart.msu.edu

FOUR 7/8" DIAMETER HOLES ON
33 3/4" DIAMETER BOLT CIRCLE

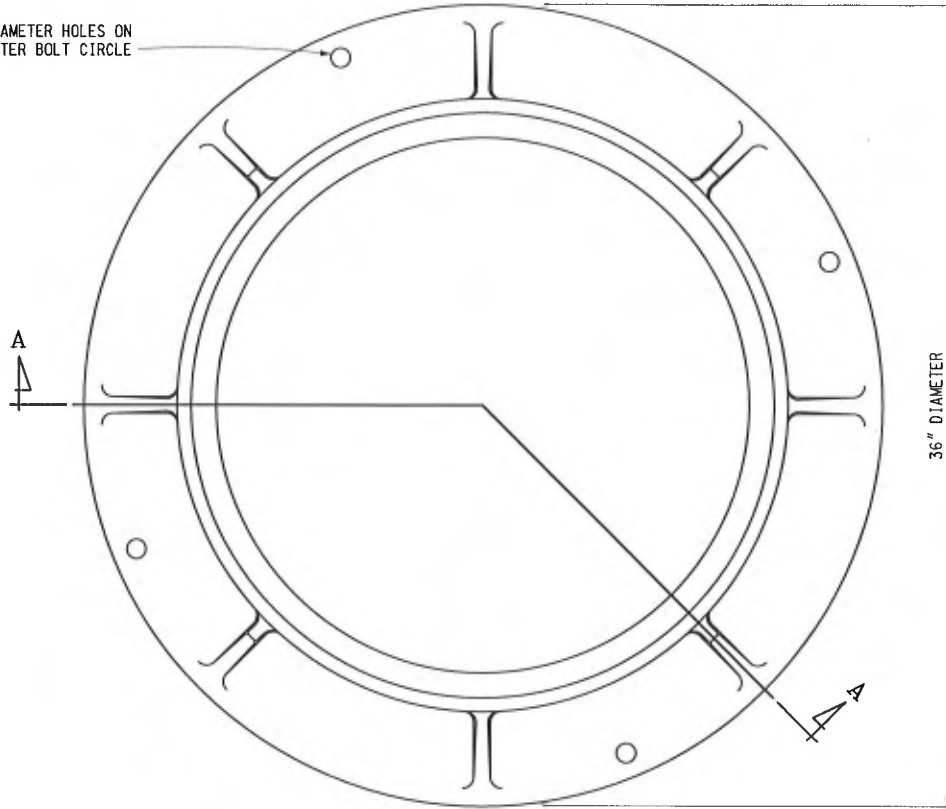

TOP VIEW OF FRAME

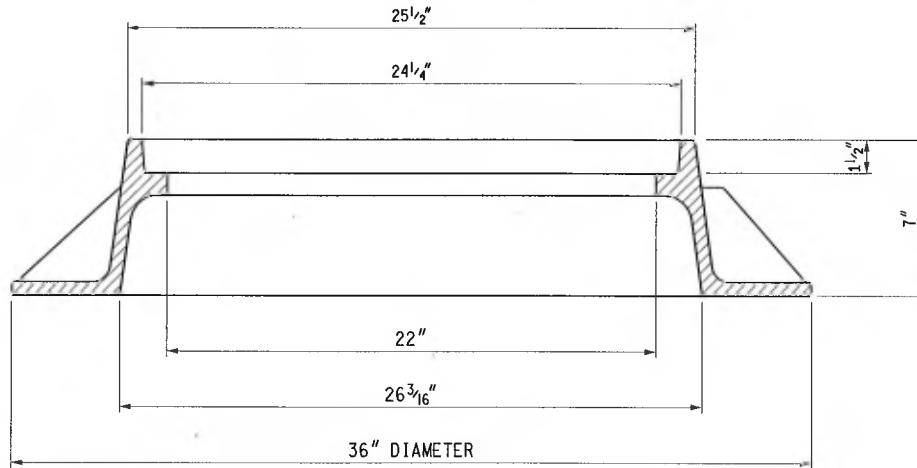

SECTION A - A



PREPARED
BY
DESIGN DIVISION

DRAWN BY: B.L.T.

CHECKED BY: W.K.P.

DEPARTMENT DIRECTOR
Kirk T. Steudle

APPROVED BY: *Randy Van Pelt*
DIRECTOR, BUREAU OF FIELD SERVICES

APPROVED BY: *Paul A. Van Pelt*
DIRECTOR, BUREAU OF HIGHWAY DEVELOPMENT

MICHIGAN DEPARTMENT OF TRANSPORTATION
BUREAU OF HIGHWAY DEVELOPMENT STANDARD PLAN FOR

COVER B
FOR USE ON MANHOLES

9-30-2014
F.H.W.A. APPROVAL

3-7-2014
PLAN DATE

R-7-F

SHEET
1 OF 2

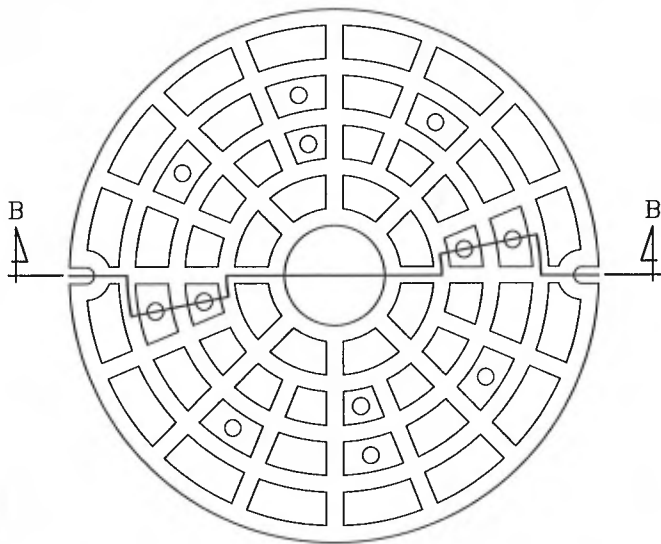

TOP VIEW OF COVER

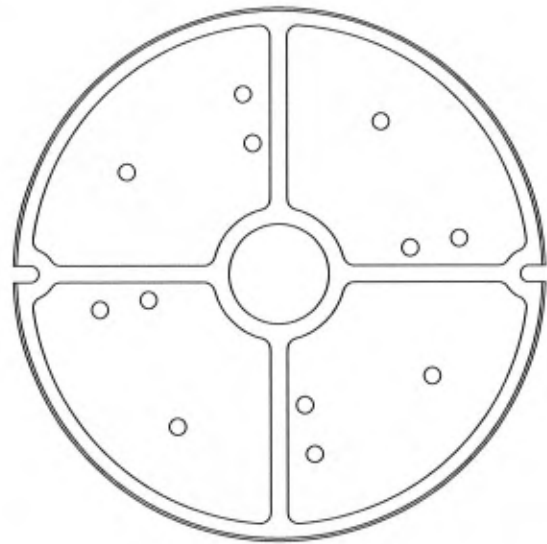

BOTTOM VIEW OF COVER

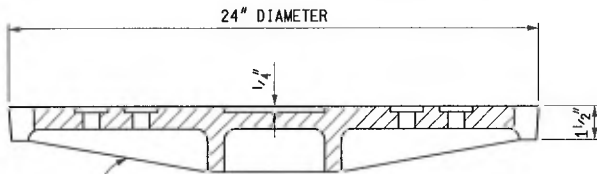

ALTERNATE PROFILES PERMITTED
SECTION B - B

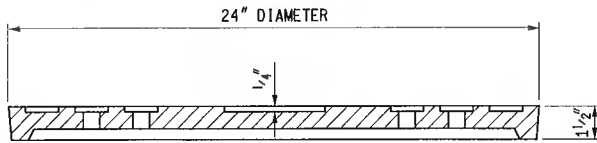

SECTION B - B
ALTERNATE PROFILE EXAMPLE

NOTES:

THE CASTINGS SHALL MEET THE REQUIREMENTS OF THE CURRENT STANDARD SPECIFICATION FOR GRAY IRON CASTINGS.

ALL CASTINGS SHALL BE CLEANED BY CURRENT APPROVED BLASTING METHODS.

THE SEATING FACE OF THE LID AND THE SEAT FOR THE SAME ON THE FRAME SHALL BE GROUND OR MACHINED SO THAT THE LID WILL HAVE AN EVEN BEARING ON ITS SEAT TO PREVENT ROCKING OR TILTING.

THE CASTINGS SHALL BE FREE OF POURING FAULTS, BLOW HOLES, CRACKS AND OTHER IMPERFECTIONS. THEY SHALL BE SOUND, TRUE TO FORM AND THICKNESS, CLEAN AND NEATLY FINISHED, AND SHALL BE COATED WITH COAL TAR PITCH VARNISH.

THIS COVER IS DESIGNED TO FIT ON ANY MANHOLE OR ON ANY EXISTING SIMILAR STRUCTURE WHEN SO DESIGNATED ON THE PLANS.

MICHIGAN DEPARTMENT OF TRANSPORTATION
BUREAU OF HIGHWAY DEVELOPMENT STANDARD PLAN FOR

COVER B
FOR USE ON MANHOLES

9-30-2014
F.H.W.A. APPROVAL

3-7-2014
PLAN DATE

R-7-F

SHEET
2 OF 2

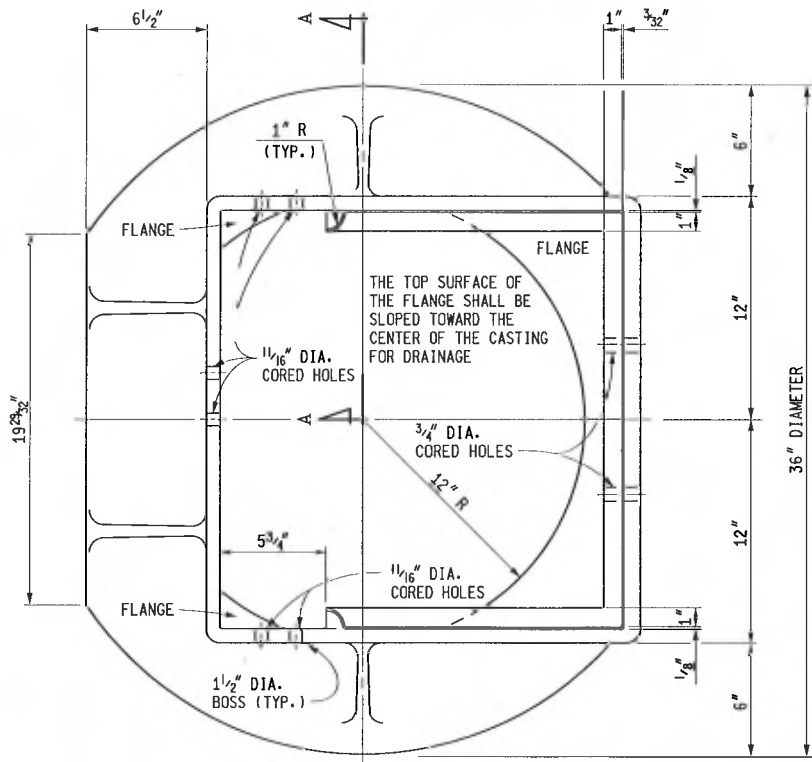

PLAN VIEW OF FRAME

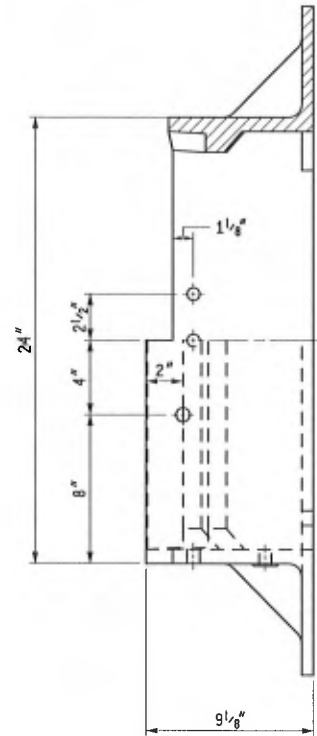

FRONT ELEVATION OF FRAME SECTION A - A

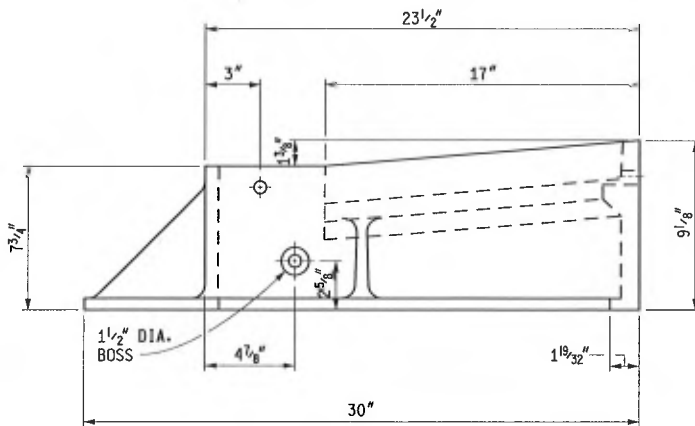

SIDE ELEVATION OF FRAME



PREPARED BY
DESIGN DIVISION

DRAWN BY: B.L.T.

CHECKED BY: W.K.P.

DEPARTMENT DIRECTOR
Kirk T. Steudle

APPROVED BY: *Randy Van Pelt*
DIRECTOR, BUREAU OF FIELD SERVICES

APPROVED BY: *Mark A. Van Pelt*
DIRECTOR, BUREAU OF HIGHWAY DEVELOPMENT

MICHIGAN DEPARTMENT OF TRANSPORTATION
BUREAU OF HIGHWAY DEVELOPMENT STANDARD PLAN FOR

COVER C
FOR USE WITH
CONCRETE CURB & GUTTER, DETAIL D

9-30-2014
F.H.W.A. APPROVAL

5-15-2014
PLAN DATE

R-8-D

SHEET
1 OF 3

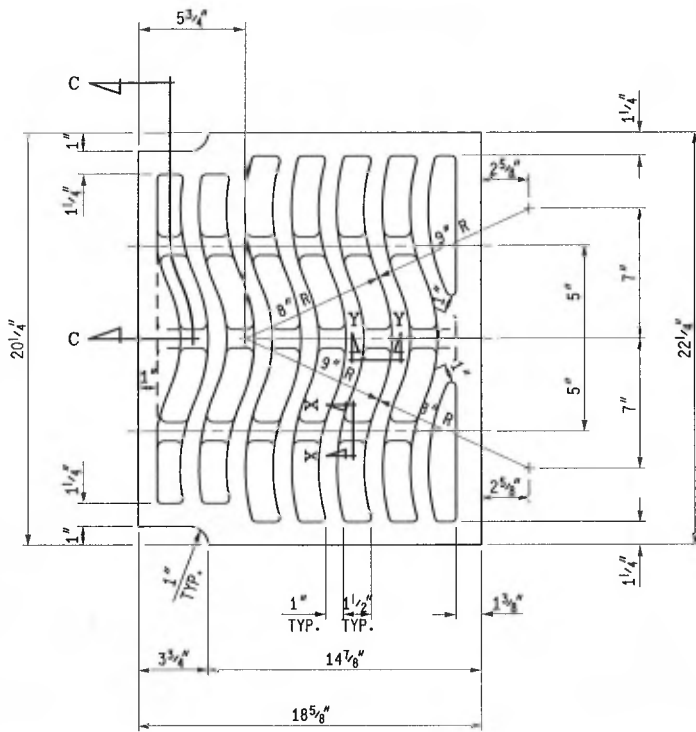

PLAN VIEW OF GRATE

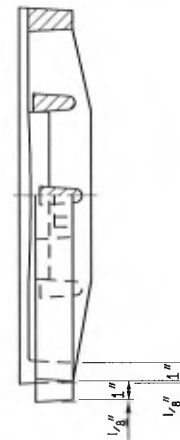

SECTION C - C
HALF FRONT ELEVATION

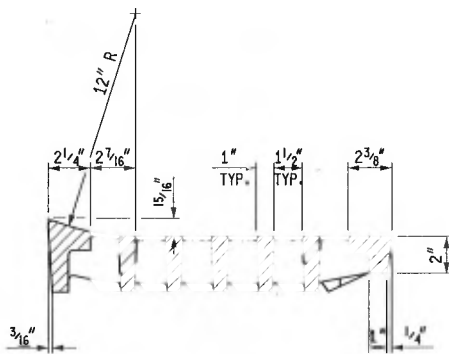

SECTION B - B

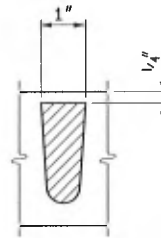

SECTION X - X

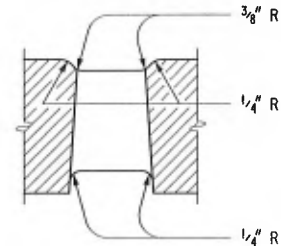

SECTION Y - Y

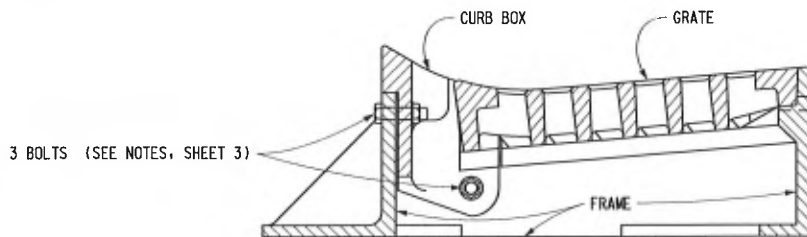

COVER C ASSEMBLY

MICHIGAN DEPARTMENT OF TRANSPORTATION
BUREAU OF HIGHWAY DEVELOPMENT STANDARD PLAN FOR

COVER C

FOR USE WITH
CONCRETE CURB & GUTTER, DETAIL D

9-30-2014
F.H.W.A. APPROVAL

5-15-2014
PLAN DATE

R-8-D

SHEET
2 OF 3

NOTE:
BOLT CURB BOX FIRMLY TO FRAME AT FOUNDRY WITH THREE
 $\frac{5}{8}$ " DIAMETER x $2\frac{1}{2}$ " GALVANIZED MACHINE BOLTS WITH
WASHERS AND NUT ENDS. (SEE NOTES)

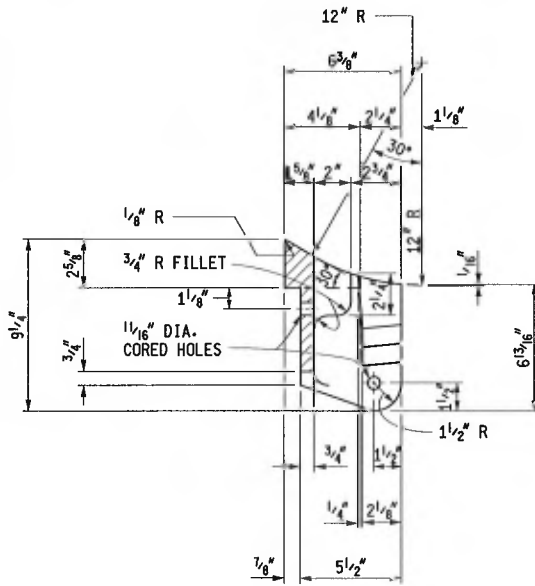

SECTION D - D

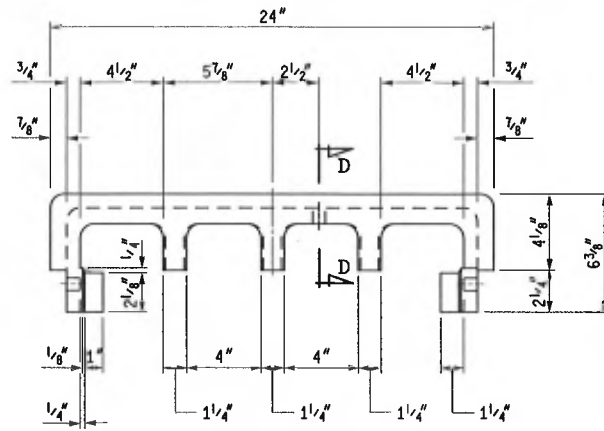

PLAN VIEW OF CURB BOX

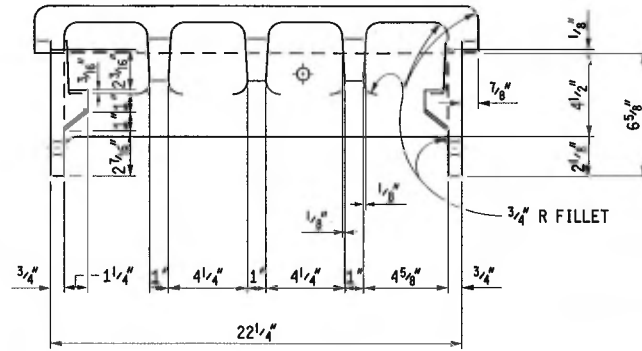

FRONT ELEVATION OF CURB BOX

NOTES:

THE CASTINGS SHALL MEET THE REQUIREMENTS OF THE CURRENT STANDARD SPECIFICATION FOR GRAY IRON CASTINGS.

ALL CASTINGS SHALL BE CLEANED BY CURRENT APPROVED BLASTING METHODS.

THE SEATING FACE OF THE GRATE AND THE SEAT FOR THE SAME ON THE FRAME AND THE CURB BOX SHALL BE GROUND SO THAT THE GRATE WILL HAVE AN EVEN BEARING ON ITS SEAT TO PREVENT ROCKING OR TILTING.

THE CASTINGS SHALL BE FREE OF POURING FAULTS, BLOW HOLES, CRACKS AND OTHER IMPERFECTIONS. THEY SHALL BE SOUND, TRUE TO FORM AND THICKNESS, CLEAN AND NEATLY FINISHED, AND SHALL BE COATED WITH COAL TAR PITCH VARNISH.

THE BEARING SURFACES BETWEEN CURB BOX AND FRAME SHALL BE GROUND AND SEATED SO AS TO PROVIDE AN EVEN BEARING THROUGHOUT. THE CURB BOX SHALL BE FIRMLY BOLTED IN PLACE ON THE FRAME BEFORE FINISHING OF THE GRATE SEATS IS DONE. GALVANIZED IRON WASHERS AND SHIMS SHALL BE PLACED BETWEEN FRAME AND ENDS OF CURB BOX SO AS BREAKING OF CURB BOX WHEN THESE BOLTS ARE TIGHTENED.

THE CURB BOX AND BOTH SECTIONS SHALL BE SHIPPED ASSEMBLED.

THIS COVER IS DESIGNED TO FIT ON ANY INLET, CATCH BASIN OR ON ANY EXISTING SIMILAR STRUCTURE WHEN SO DESIGNATED ON THE PLANS.

MICHIGAN DEPARTMENT OF TRANSPORTATION
BUREAU OF HIGHWAY DEVELOPMENT STANDARD PLAN FOR

COVER C
FOR USE WITH
CONCRETE CURB & GUTTER, DETAIL D

9-30-2014
F.H.W.A. APPROVAL

5-15-2014
PLAN DATE

R-8-D

SHEET
3 OF 3

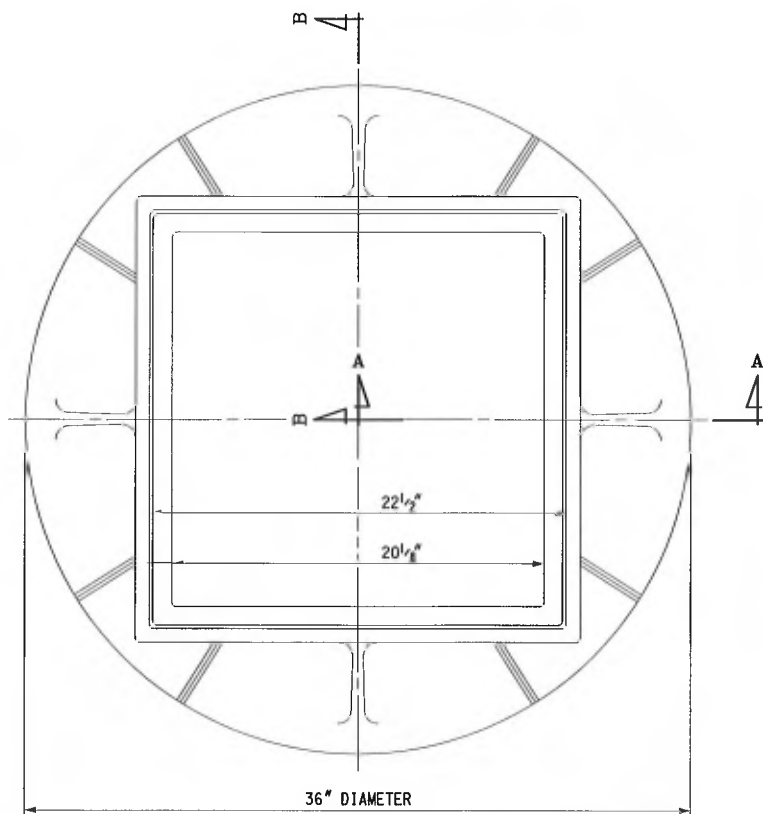

PLAN VIEW OF FRAME

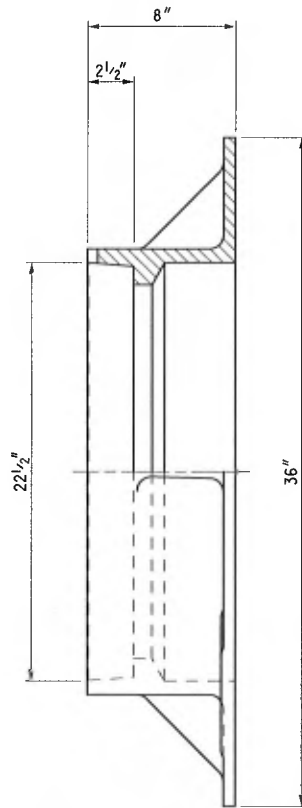

SECTION B - B
HALF FRONT ELEVATION

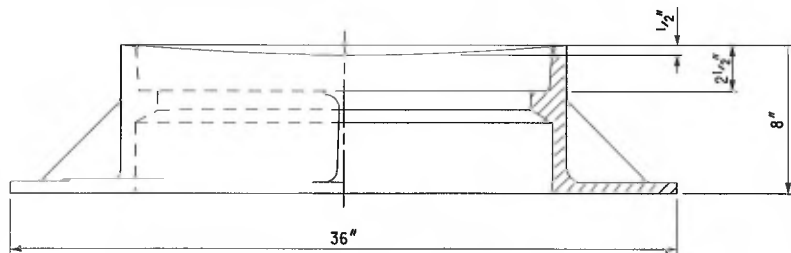

HALF SIDE ELEVATION

SECTION A - A



PREPARED BY
DESIGN DIVISION

DRAWN BY: B.L.T.

CHECKED BY: W.K.P.

DEPARTMENT DIRECTOR
Kirk T. Steudle

APPROVED BY: *Randy Van Pelt*
DIRECTOR, BUREAU OF FIELD SERVICES

APPROVED BY: *Mark A. Van Pelt*
DIRECTOR, BUREAU OF HIGHWAY DEVELOPMENT

MICHIGAN DEPARTMENT OF TRANSPORTATION
BUREAU OF HIGHWAY DEVELOPMENT STANDARD PLAN FOR

COVER D
FOR USE WITH
STRAIGHT CURB AND CURB & GUTTER

9-30-2014
F.H.W.A. APPROVAL

4-29-2014
PLAN DATE

R-9-D

SHEET
1 OF 2

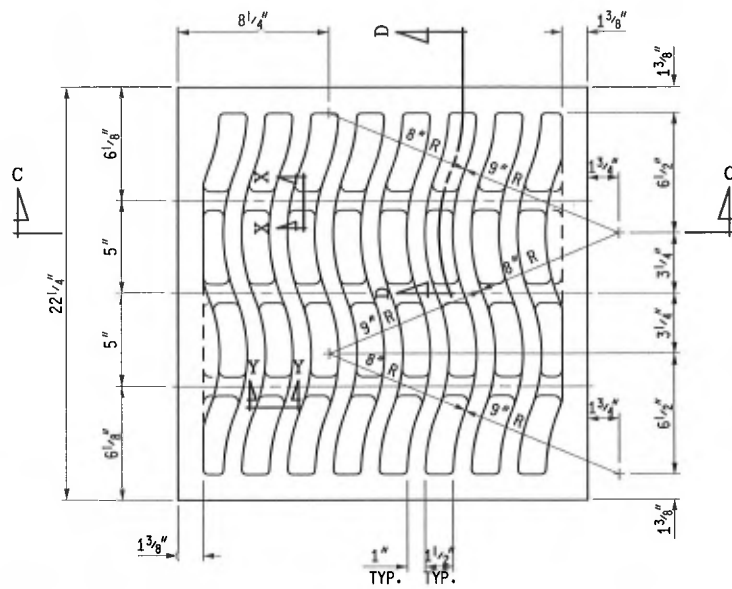

PLAN VIEW OF GRATE

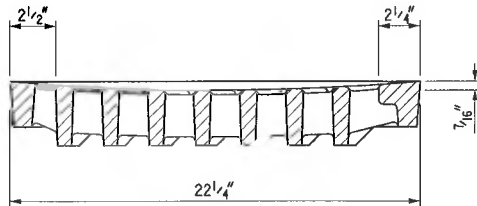
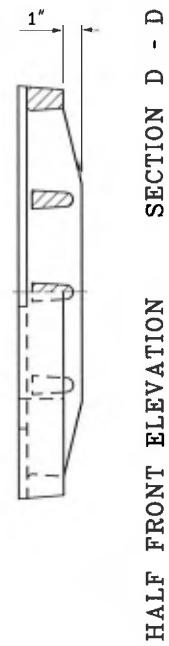

SECTION C - C

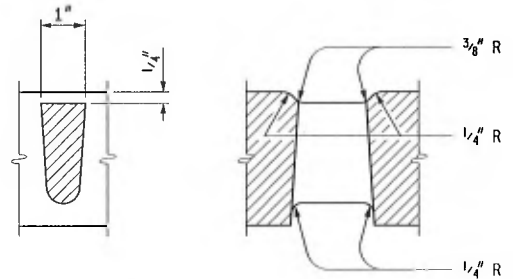

SECTION X - X SECTION Y - Y

NOTES:

THE CASTINGS SHALL MEET THE REQUIREMENTS OF THE CURRENT STANDARD SPECIFICATION FOR GRAY IRON CASTINGS.

ALL CASTINGS SHALL BE CLEANED BY CURRENT APPROVED BLASTING METHODS.

THE SEATING FACE OF THE GRATE AND THE SEAT FOR THE SAME ON THE FRAME AND THE CURB BOX SHALL BE GROUND SO THAT THE GRATE WILL HAVE AN EVEN BEARING ON ITS SEAT TO PREVENT ROCKING OR TILTING.

THE CASTINGS SHALL BE FREE OF POURING FAULTS, BLOW HOLES, CRACKS AND OTHER IMPERFECTIONS. THEY SHALL BE SOUND, TRUE TO FORM AND THICKNESS, CLEAN AND NEATLY FINISHED, AND SHALL BE COATED WITH COAL TAR PITCH VARNISH.

THIS COVER IS DESIGNED TO FIT ON ANY INLET, CATCH BASIN OR ON ANY EXISTING SIMILAR STRUCTURE WHEN SO DESIGNATED ON THE PLANS.

MICHIGAN DEPARTMENT OF TRANSPORTATION
BUREAU OF HIGHWAY DEVELOPMENT STANDARD PLAN FOR

COVER D

FOR USE WITH
STRAIGHT CURB AND CURB & GUTTER

9-30-2014
F.H.W.A. APPROVAL

4-29-2014
PLAN DATE

R-9-D

SHEET
2 OF 2

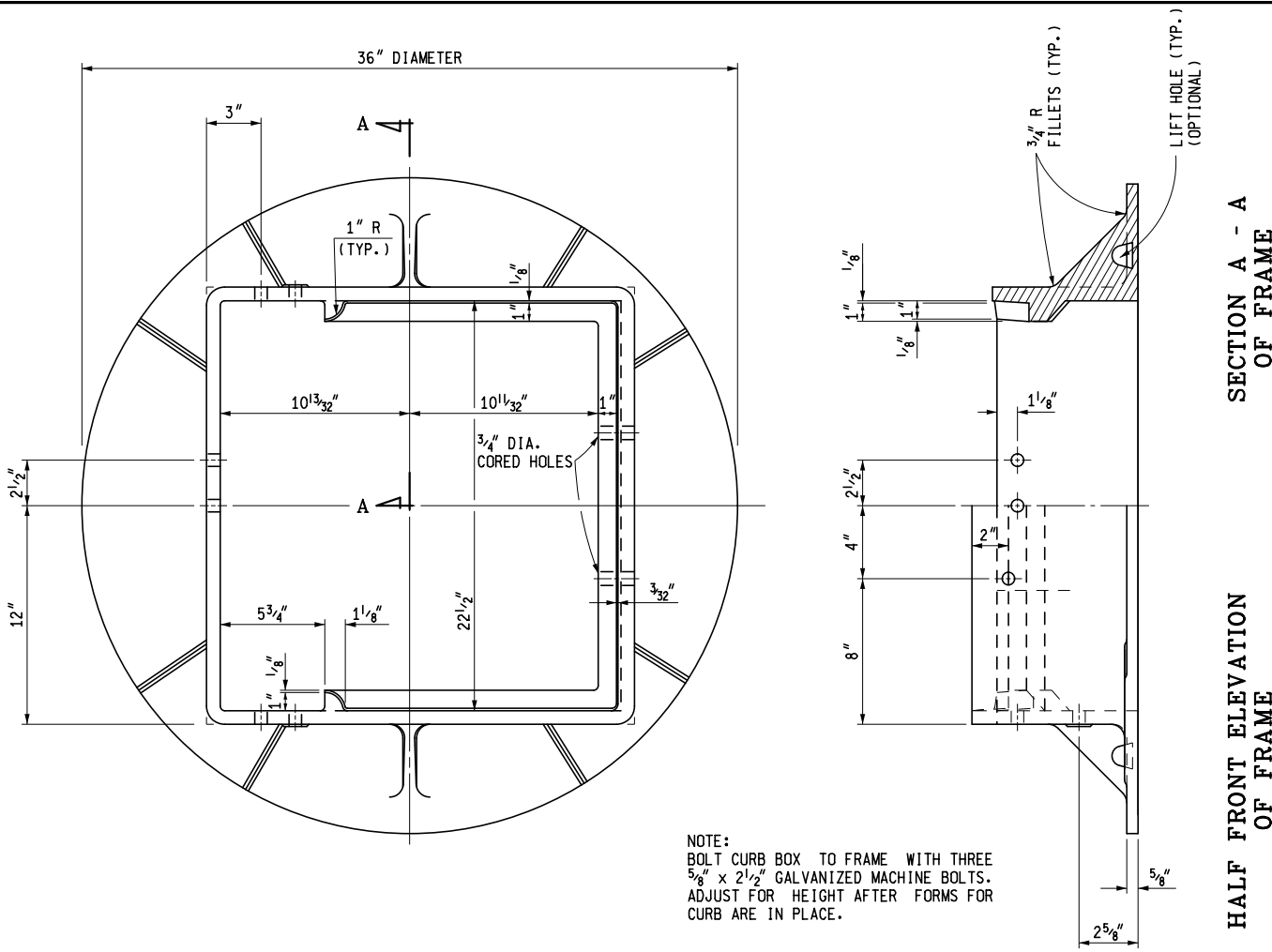

PLAN VIEW OF FRAME

NOTE:
 BOLT CURB BOX TO FRAME WITH THREE
 5/8" x 2 1/2" GALVANIZED MACHINE BOLTS.
 ADJUST FOR HEIGHT AFTER FORMS FOR
 CURB ARE IN PLACE.

SECTION A - A
 OF FRAME
 HALF FRONT ELEVATION
 OF FRAME

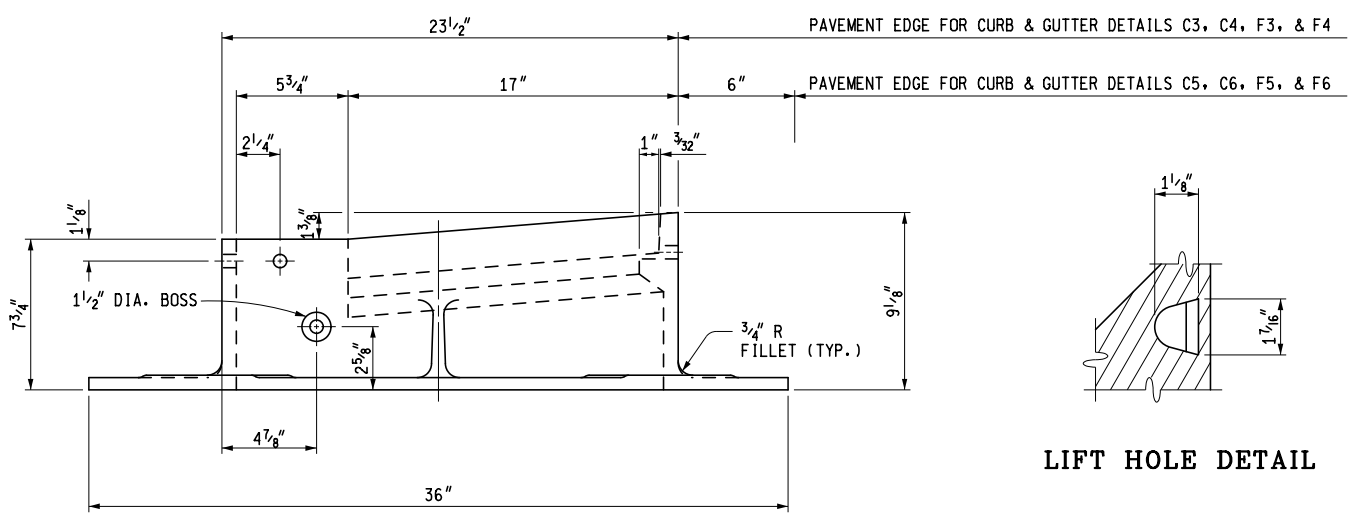

SIDE ELEVATION OF FRAME

LIFT HOLE DETAIL

	DEPARTMENT DIRECTOR Paul C. Ajegba	MICHIGAN DEPARTMENT OF TRANSPORTATION BUREAU OF DEVELOPMENT STANDARD PLAN FOR		
	PREPARED BY DESIGN DIVISION	APPROVED BY: _____ DIRECTOR, BUREAU OF FIELD SERVICES	COVER K FOR USE WITH CONCRETE CURB & GUTTER DETAILS C, E & F	
DRAWN BY: <u>B.L.T.</u>	APPROVED BY: _____ DIRECTOR, BUREAU OF DEVELOPMENT	7-26-2019 PLAN DATE	R-15-G	SHEET 1 OF 3
CHECKED BY: <u>W.K.P.</u>		F.H.W.A. APPROVAL		

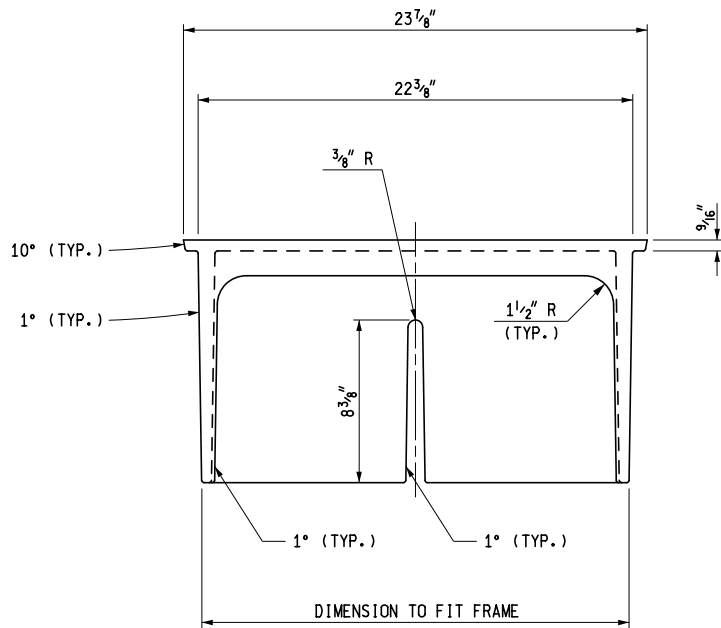

FRONT VIEW OF CURB BOX

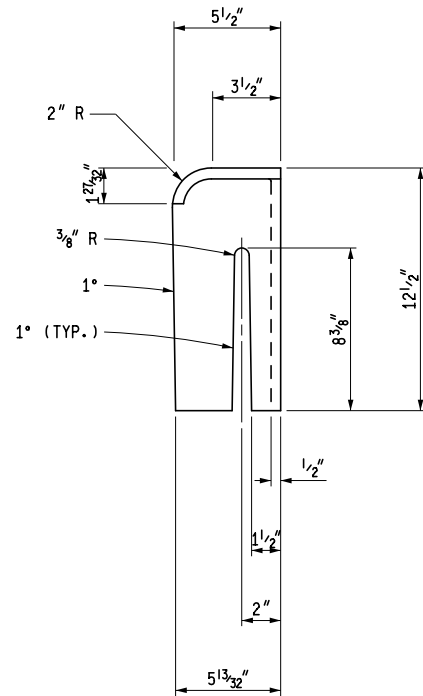

SIDE VIEW

NOTES:

THE CASTINGS SHALL MEET THE REQUIREMENTS OF THE CURRENT STANDARD SPECIFICATION FOR GRAY IRON OR DUCTILE IRON CASTINGS.

ALL CASTINGS SHALL BE CLEANED BY CURRENT APPROVED BLASTING METHODS.

THE SEATING FACE OF THE GRATE AND THE SEAT FOR THE SAME ON THE FRAME SHALL BE GROUND OR MACHINED SO THAT THE GRATE WILL HAVE AN EVEN BEARING ON ITS SEAT TO PREVENT ROCKING OR TILTING.

THE CASTINGS SHALL BE FREE OF POURING FAULTS, BLOW HOLES, CRACKS AND OTHER IMPERFECTIONS. THEY SHALL BE SOUND, TRUE TO FORM AND THICKNESS, CLEAN AND NEATLY FINISHED, AND SHALL BE COATED WITH COAL TAR PITCH VARNISH.

THE CURB BOX AND FRAME SHALL BE SHIPPED ASSEMBLED.

THIS COVER IS DESIGNED TO FIT ON ANY INLET, CATCH BASIN OR ON ANY EXISTING SIMILAR STRUCTURE WHEN SO DESIGNATED ON THE PLANS.

MICHIGAN DEPARTMENT OF TRANSPORTATION
BUREAU OF DEVELOPMENT STANDARD PLAN FOR

COVER K

FOR USE WITH CONCRETE CURB & GUTTER
DETAILS C, E & F

F.H.W.A. APPROVAL	7-26-2019 PLAN DATE	R-15-G	SHEET 3 OF 3
-------------------	------------------------	--------	-----------------

* MAXIMUM LANDING SLOPE IS 2.0% IN EACH DIRECTION OF TRAVEL. LANDING MINIMUM DIMENSIONS 5' x 5'. SEE NOTES.

** MAXIMUM RAMP CROSS SLOPE IS 2.0%, RUNNING SLOPE 5% - 7% (8.3% MAXIMUM). SEE NOTES.

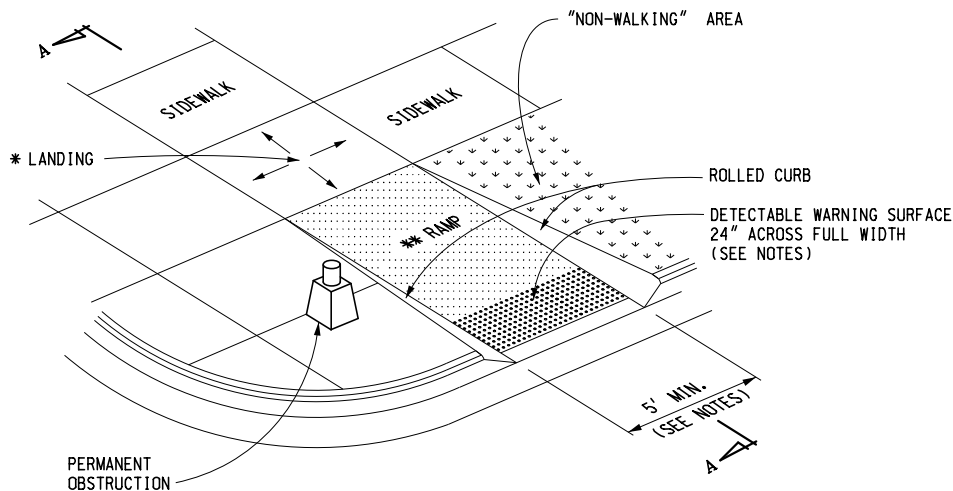

SIDEWALK RAMP TYPE R
(ROLLED SIDES)

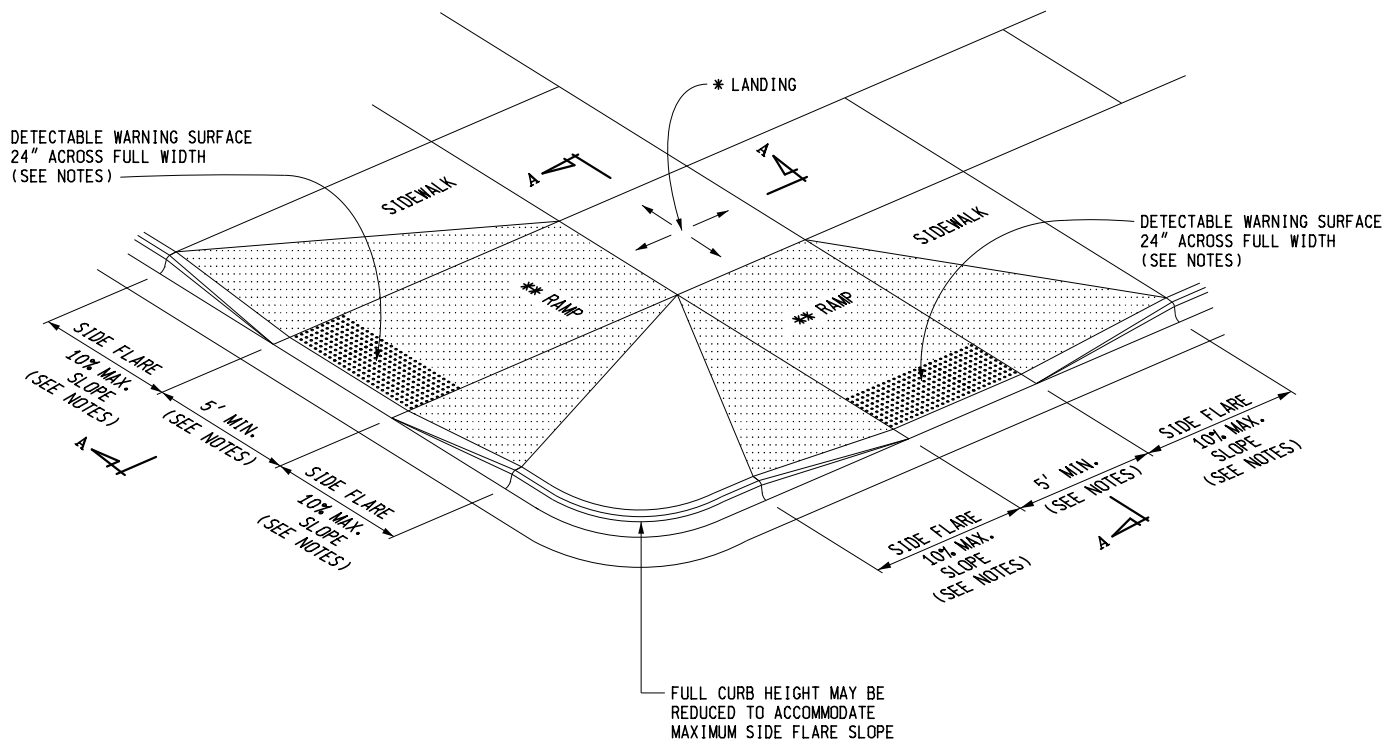

SIDEWALK RAMP TYPE F
(FLARED SIDES, TWO RAMPS SHOWN)



PREPARED BY
DESIGN DIVISION

DRAWN BY: B.L.T.

CHECKED BY: W.K.P.

DEPARTMENT DIRECTOR
Paul C. Ajegba

APPROVED BY: _____
DIRECTOR, BUREAU OF FIELD SERVICES

APPROVED BY: _____
DIRECTOR, BUREAU OF DEVELOPMENT

MICHIGAN DEPARTMENT OF TRANSPORTATION
BUREAU OF DEVELOPMENT STANDARD PLAN FOR

**SIDEWALK RAMP AND
DETECTABLE WARNING DETAILS**

F.H.W.A. APPROVAL

7-26-2019
PLAN DATE

R-28-J

SHEET
1 OF 7

* MAXIMUM LANDING SLOPE IS 2.0% IN EACH DIRECTION OF TRAVEL. LANDING MINIMUM DIMENSIONS 5' x 5'. SEE NOTES.

** MAXIMUM RAMP CROSS SLOPE IS 2.0%, RUNNING SLOPE 5% - 7% (8.3% MAXIMUM). SEE NOTES.

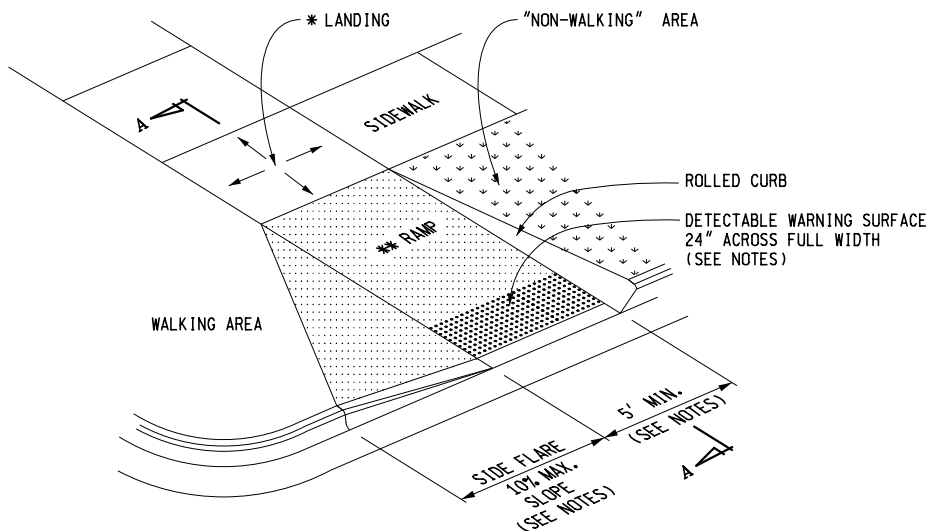

SIDEWALK RAMP TYPE RF
(ROLLED / FLARED SIDES)

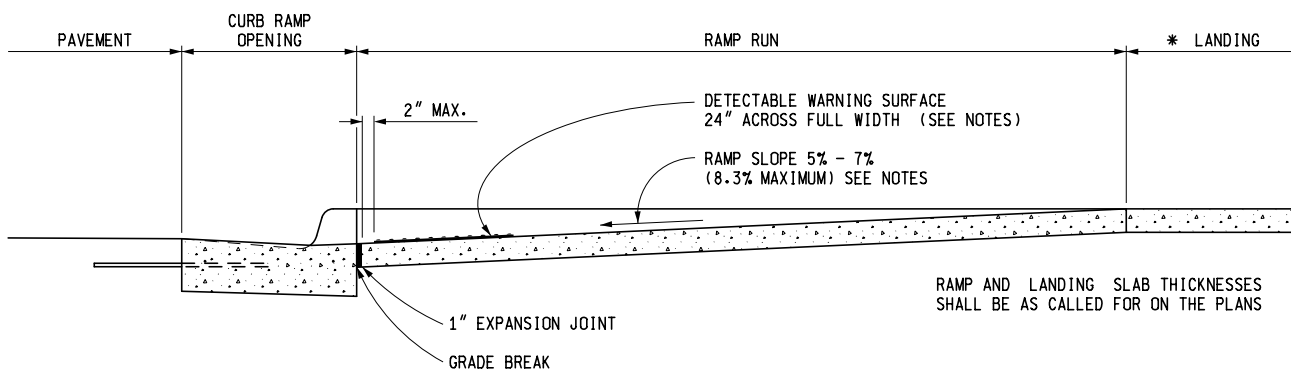

SECTION A-A

CURB TYPE	MAXIMUM RISE (INCHES)	
	A	B
B1	3/4	1
B2	3/4	1
B3	3/4	1
D1	3/4	1
D2	3/4	1
D3	3/4	1
C1	1/2	1/2
C2	1/2	1/2
C3	3/4	1/2
C4	3/4	1/2
C5	1	1/2
C6	1	1/2
F1	1/2	1/2
F2	1/2	1/2
F3	3/4	1/2
F4	3/4	1/2
F5	1	1/2
F6	1	1/2

FOR CURB TYPES SEE STANDARD PLAN R-30-SERIES

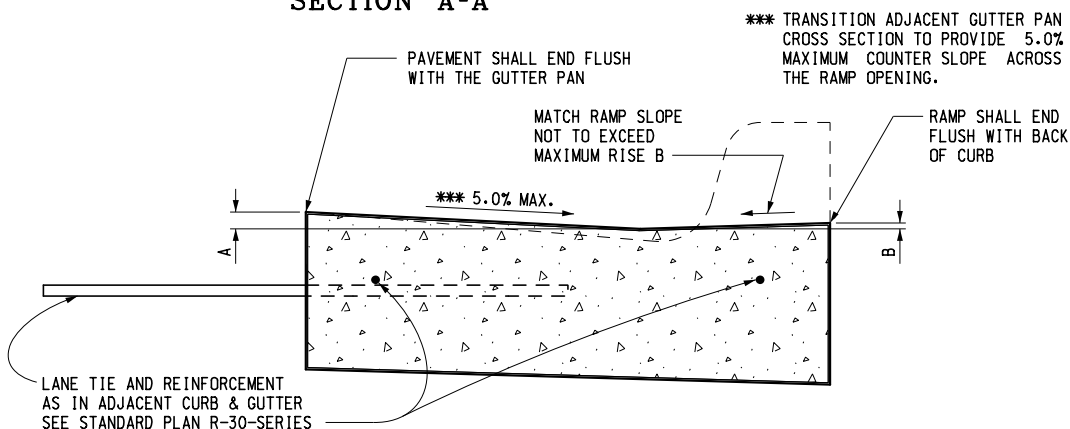

SECTION THROUGH CURB RAMP OPENING
(TYPICAL ALL RAMP TYPES)

MICHIGAN DEPARTMENT OF TRANSPORTATION
BUREAU OF DEVELOPMENT STANDARD PLAN FOR
**SIDEWALK RAMP AND
DETECTABLE WARNING DETAILS**

* MAXIMUM LANDING SLOPE IS 2.0% IN EACH DIRECTION OF TRAVEL. LANDING MINIMUM DIMENSIONS 5' x 5'. SEE NOTES.

** MAXIMUM RAMP CROSS SLOPE IS 2.0%, RUNNING SLOPE 5% - 7% (8.3% MAXIMUM). SEE NOTES.

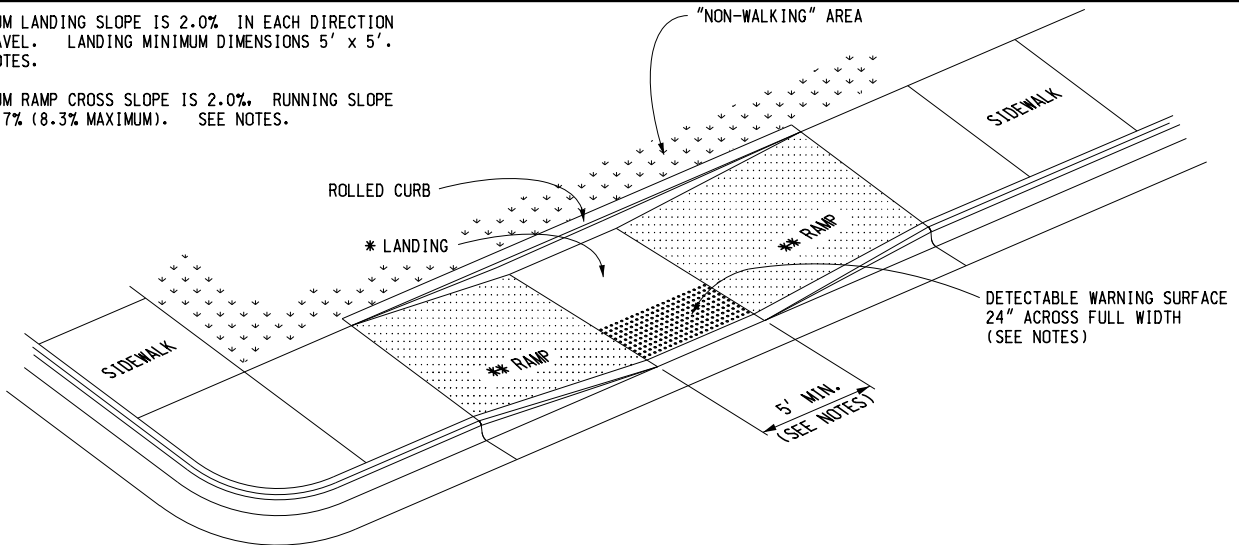

SIDEWALK RAMP TYPE P

(PARALLEL RAMP)

DO NOT USE IN AREAS WHERE PONDING MAY OCCUR

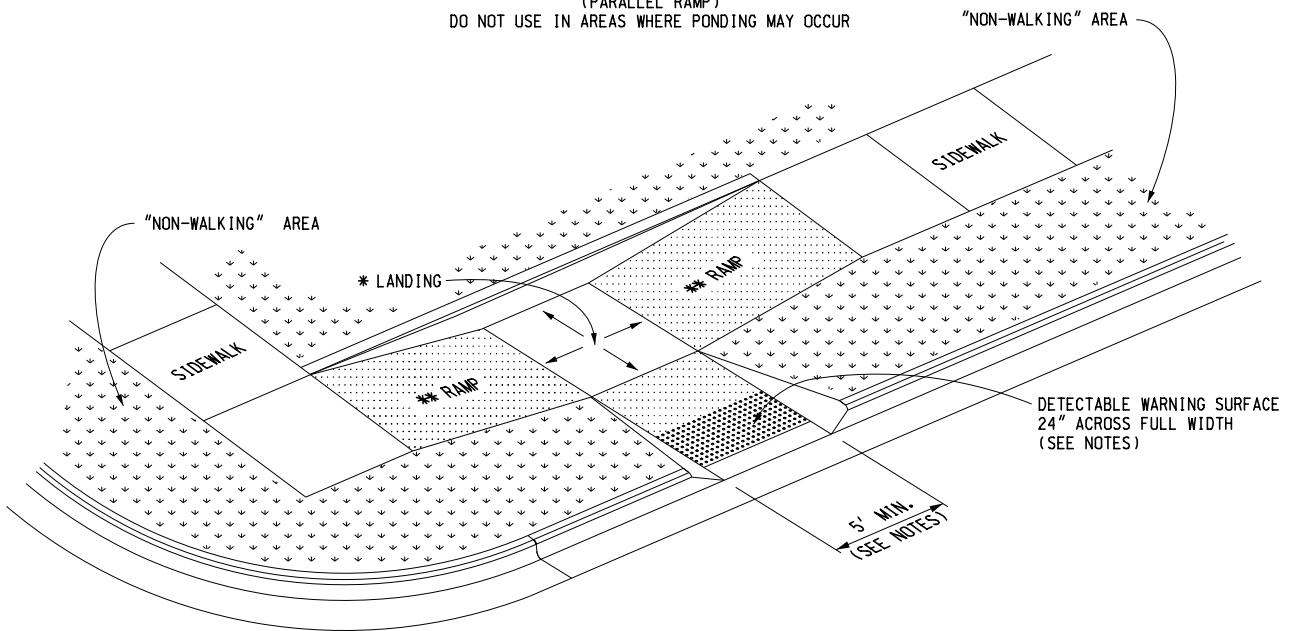

SIDEWALK RAMP TYPE C

(COMBINATION RAMP)

DETECTABLE WARNING SURFACE 24" ACROSS FULL WIDTH IF MEDIAN WIDTH IS AT LEAST 6'-0". OTHERWISE NO DETECTABLE WARNING IS REQUIRED.

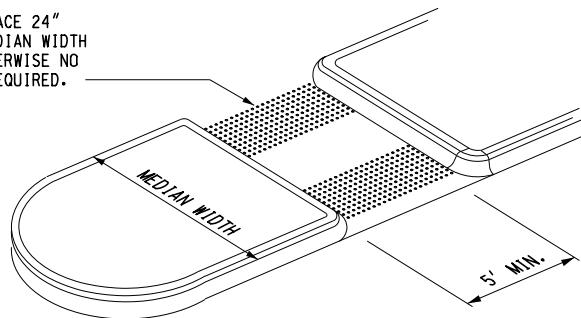

SIDEWALK RAMP TYPE M

(MEDIAN ISLAND)

MICHIGAN DEPARTMENT OF TRANSPORTATION
BUREAU OF DEVELOPMENT STANDARD PLAN FOR

**SIDEWALK RAMP AND
DETECTABLE WARNING DETAILS**

F.H.W.A. APPROVAL

7-26-2019
PLAN DATE

R-28-J

SHEET
3 OF 7

* MAXIMUM LANDING SLOPE IS 2.0% IN EACH DIRECTION OF TRAVEL. LANDING MINIMUM DIMENSIONS 5' x 5'. SEE NOTES.

** MAXIMUM RAMP CROSS SLOPE IS 2.0%, RUNNING SLOPE 5% - 7% (8.3% MAXIMUM). SEE NOTES.

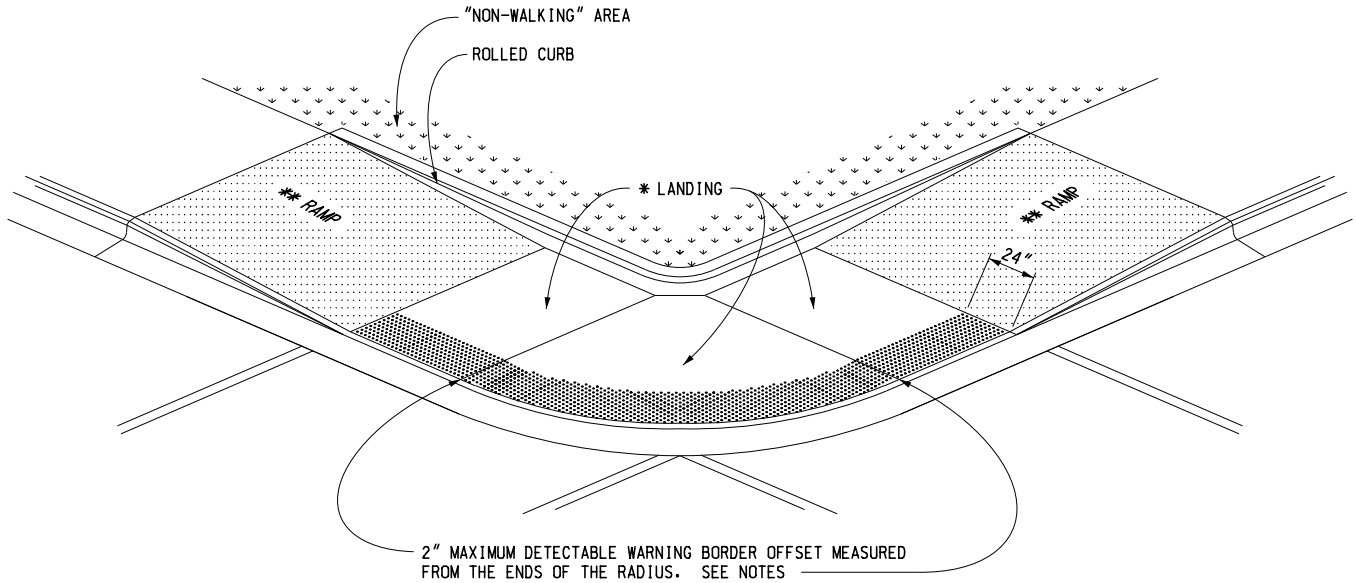

(RADIAL DETECTABLE WARNING SHOWN)

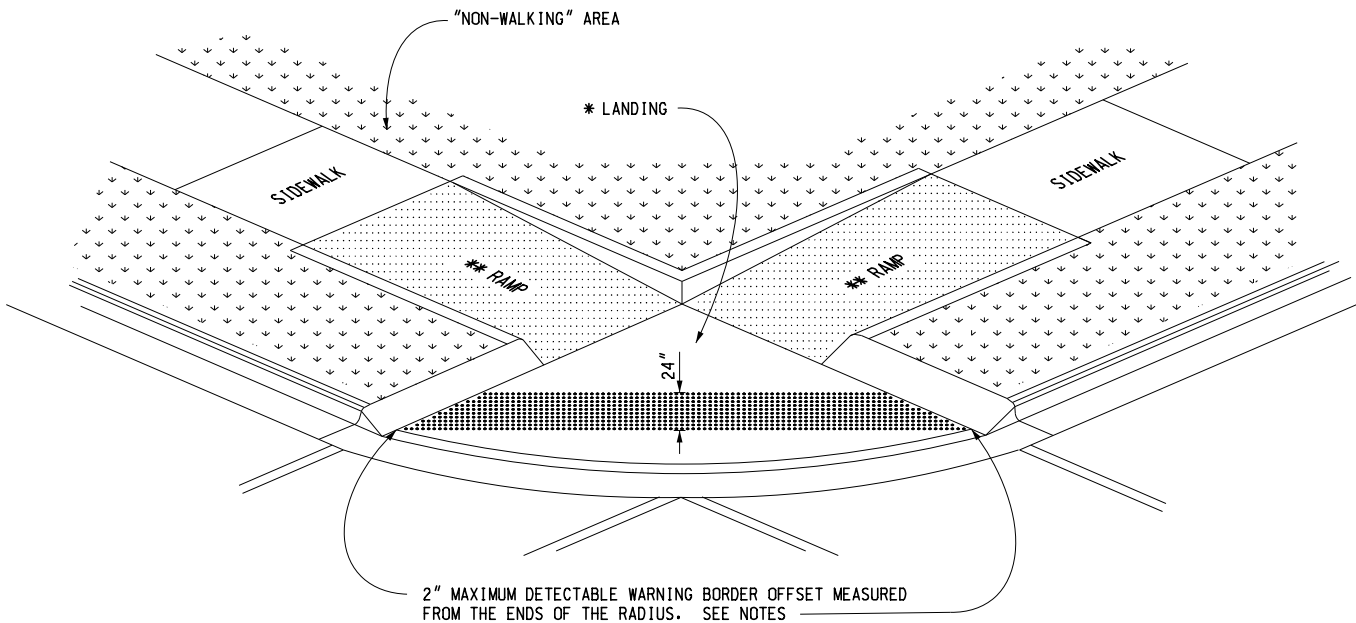

(TANGENT DETECTABLE WARNING SHOWN)

SIDEWALK RAMP TYPE D

(DEPRESSED CORNER)

USE ONLY WHEN INDEPENDENT DIRECTIONAL RAMPS CAN NOT BE CONSTRUCTED FOR EACH CROSSING DIRECTION

MICHIGAN DEPARTMENT OF TRANSPORTATION
BUREAU OF DEVELOPMENT STANDARD PLAN FOR

**SIDEWALK RAMP AND
DETECTABLE WARNING DETAILS**

F.H.W.A. APPROVAL

7-26-2019
PLAN DATE

R-28-J

SHEET
4 OF 7

* THE DETECTABLE WARNING SURFACE SHALL BE LOCATED SO THAT THE EDGE NEAREST THE RAIL CROSSING IS 6' MINIMUM AND 15' MAXIMUM FROM THE CENTERLINE OF THE NEAREST RAIL. DO NOT PLACE DETECTABLE WARNING ON RAILROAD CROSSING MATERIAL.

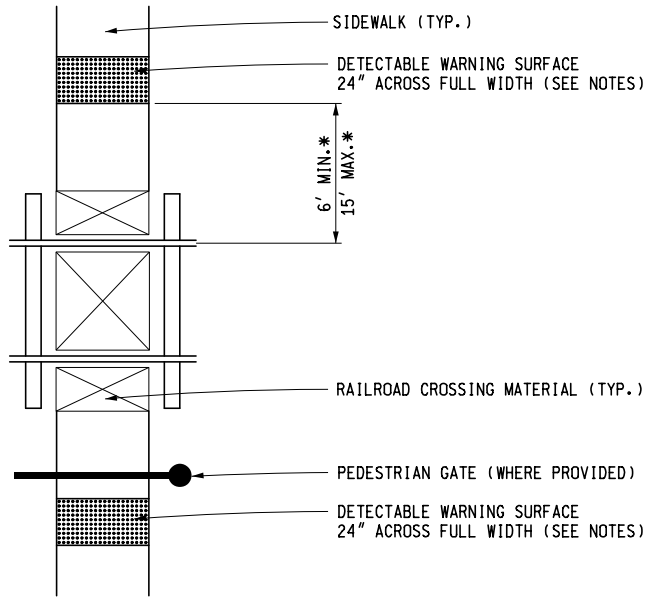

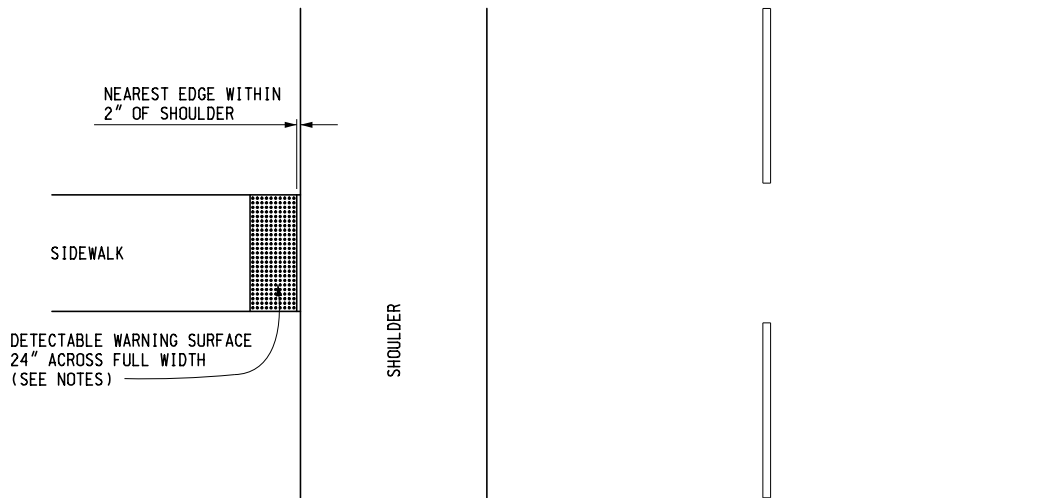

DETECTABLE WARNING AT RAILROAD CROSSING



DETECTABLE WARNING AT FLUSH SHOULDER OR ROADWAY

MICHIGAN DEPARTMENT OF TRANSPORTATION BUREAU OF DEVELOPMENT STANDARD PLAN FOR		
SIDEWALK RAMP AND DETECTABLE WARNING DETAILS		
F.H.W.A. APPROVAL	7-26-2019 PLAN DATE	R-28-J
		SHEET 5 OF 7

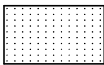
LEGEND

	SLOPED SURFACE
	DETECTABLE WARNING
	"NON-WALKING" AREA
	CROSSWALK MARKING
	PREFERRED LOCATION OF DRAINAGE INLET (TYP.)
	ALTERNATE LOCATION OF DRAINAGE INLET (TYP.)

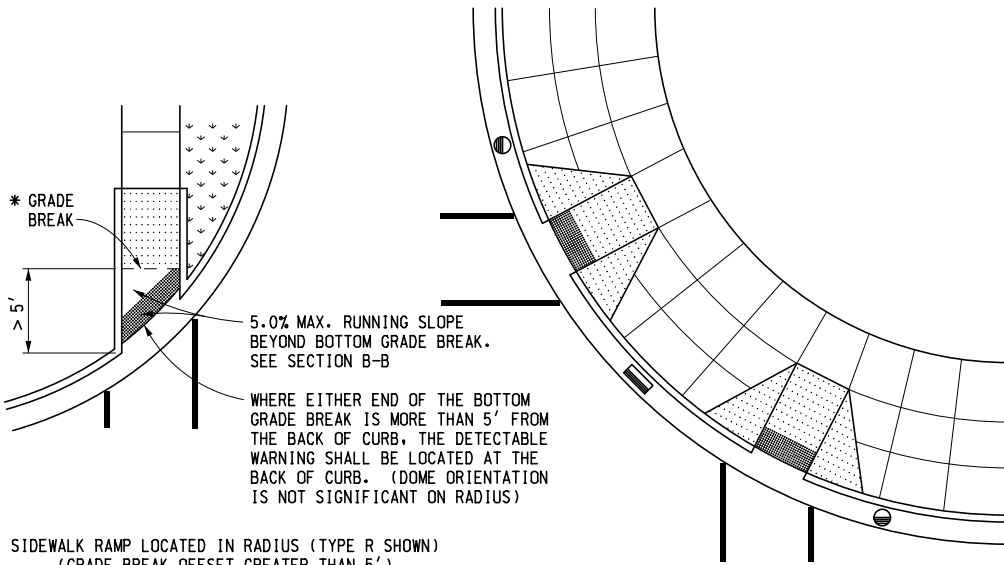

SIDEWALK RAMP LOCATED IN RADIUS (TYPE R SHOWN)
(GRADE BREAK OFFSET GREATER THAN 5')

SIDEWALK RAMP PERPENDICULAR TO RADIAL CURB (TYPE F SHOWN)
(USE WITH RADIAL CURB WHEN THE CROSSWALK AND SIDEWALK RAMP ARE NOT ALIGNED)

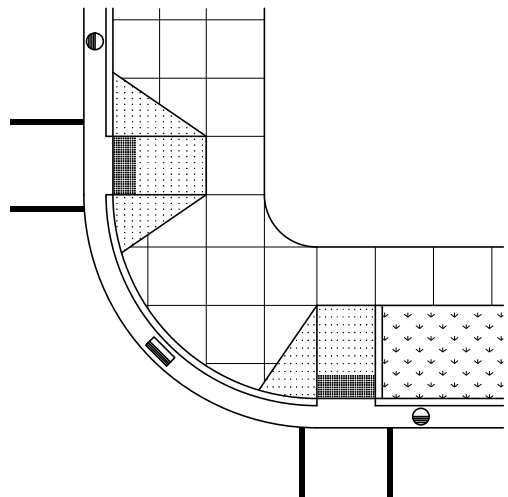

SIDEWALK RAMP PERPENDICULAR TO TANGENT CURB
(TYPE F AND TYPE RF SHOWN)

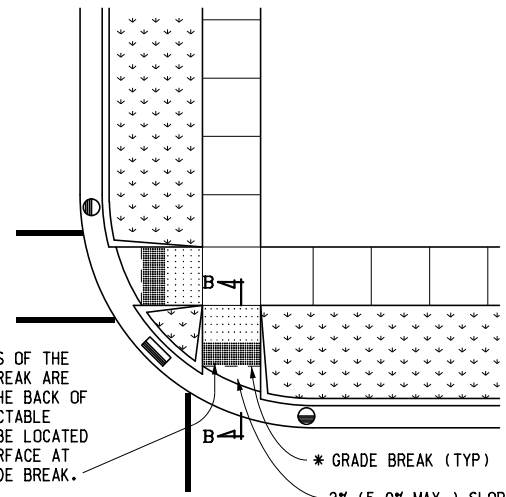

SIDEWALK RAMP LOCATED IN RADIUS (TYPE R SHOWN)
(GRADE BREAK OFFSET LESS THAN 5')

WHERE BOTH ENDS OF THE BOTTOM GRADE BREAK ARE WITHIN 5' OF THE BACK OF CURB, THE DETECTABLE WARNING SHALL BE LOCATED ON THE RAMP SURFACE AT THE BOTTOM GRADE BREAK.

* GRADE BREAK (TYP.)
2% (5.0% MAX.) SLOPE BEYOND BOTTOM GRADE BREAK

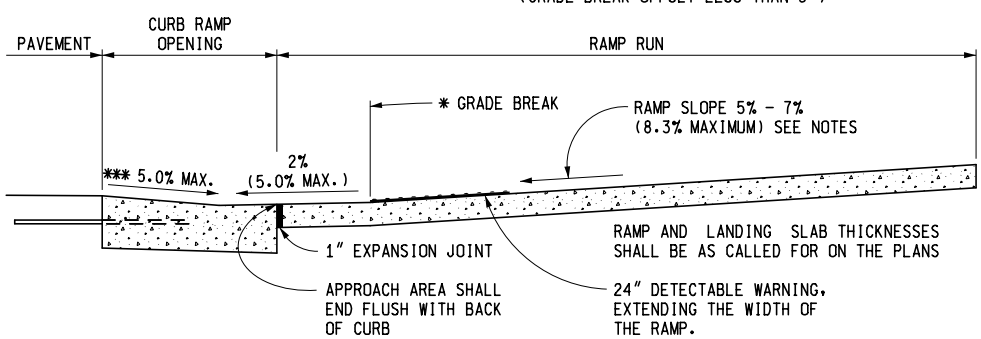

* GRADE BREAKS AT THE TOP AND BOTTOM OF CURB RAMPS SHALL BE PERPENDICULAR TO THE DIRECTION OF TRAVEL.

*** TRANSITION ADJACENT GUTTER PAN CROSS SECTION TO PROVIDE 5.0% MAXIMUM COUNTER SLOPE ACROSS THE RAMP OPENING.

SEE SHEET 2 FOR CURB RAMP OPENING DETAILS.

SECTION B-B

SIDEWALK RAMP ORIENTATION

MICHIGAN DEPARTMENT OF TRANSPORTATION
BUREAU OF DEVELOPMENT STANDARD PLAN FOR

**SIDEWALK RAMP AND
DETECTABLE WARNING DETAILS**

F.H.W.A. APPROVAL	7-26-2019 PLAN DATE	R-28-J	SHEET 6 OF 7
-------------------	------------------------	--------	-----------------

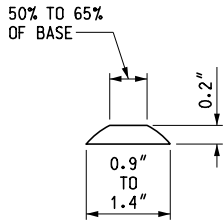

DOME SECTION

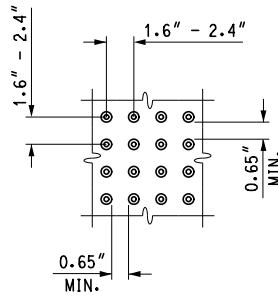

DOME SPACING

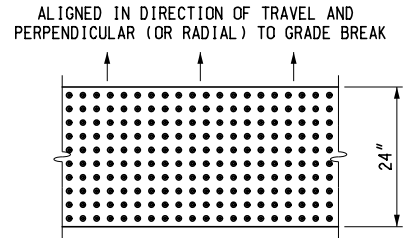

DOME ALIGNMENT

DETECTABLE WARNING DETAILS

NOTES:

DETAILS SPECIFIED ON THIS PLAN APPLY TO ALL CONSTRUCTION, RECONSTRUCTION, OR ALTERATION OF STREETS, CURBS, OR SIDEWALKS IN THE PUBLIC RIGHT OF WAY.

SIDEWALK RAMPS ARE TO BE LOCATED AS SPECIFIED ON THE PLANS OR AS DIRECTED BY THE ENGINEER.

RAMPS SHALL BE PROVIDED AT ALL CORNERS OF AN INTERSECTION WHERE THERE IS EXISTING OR PROPOSED SIDEWALK AND CURB. RAMPS SHALL ALSO BE PROVIDED AT MARKED AND/OR SIGNALIZED MID-BLOCK CROSSINGS.

SURFACE TEXTURE OF THE RAMP SHALL BE THAT OBTAINED BY A COARSE BROOMING, TRANSVERSE TO THE RUNNING SLOPE.

SIDEWALK SHALL BE RAMPED WHERE THE DRIVEWAY CURB IS EXTENDED ACROSS THE WALK.

CARE SHALL BE TAKEN TO ASSURE A UNIFORM GRADE ON THE RAMP. WHERE CONDITIONS PERMIT, IT IS DESIRABLE THAT THE SLOPE OF THE RAMP BE IN ONLY ONE DIRECTION, PARALLEL TO THE DIRECTION OF TRAVEL.

RAMP WIDTH SHALL BE INCREASED, IF NECESSARY, TO ACCOMMODATE SIDEWALK SNOW REMOVAL EQUIPMENT NORMALLY USED BY THE MUNICIPALITY.

WHEN 5' MINIMUM WIDTHS ARE NOT PRACTICABLE, RAMP WIDTH MAY BE REDUCED TO NOT LESS THAN 4' AND LANDINGS TO NOT LESS THAN 4' x 4'.

CURB RAMPS WITH A RUNNING SLOPE ≤5% DO NOT REQUIRE A TOP LANDING. HOWEVER, ANY CONTINUOUS SIDEWALK OR PEDESTRIAN ROUTE CROSSING THROUGH OR INTERSECTING THE CURB RAMP MUST INDEPENDENTLY MAINTAIN A CROSS SLOPE NOT GREATER THAN 2% PERPENDICULAR TO ITS OWN DIRECTION(S) OF TRAVEL.

DETECTABLE WARNING SURFACE COVERAGE IS 24" MINIMUM IN THE DIRECTION OF RAMP/PATH TRAVEL AND THE FULL WIDTH OF THE RAMP/PATH OPENING EXCLUDING CURBED OR FLARED CURB TRANSITION AREAS. A BORDER OFFSET NOT GREATER THAN 2" MEASURED ALONG THE EDGES OF THE DETECTABLE WARNING IS ALLOWABLE. FOR RADIAL CURB THE OFFSET IS MEASURED FROM THE ENDS OF THE RADIUS.

FOR NEW ROADWAY CONSTRUCTION, THE RAMP CROSS SLOPE MAY NOT EXCEED 2.0%. FOR ALTERATIONS TO EXISTING ROADWAYS, THE CROSS SLOPE MAY BE TRANSITIONED TO MEET AN EXISTING ROADWAY GRADE. THE CROSS SLOPE TRANSITION SHALL BE APPLIED UNIFORMLY OVER THE FULL LENGTH OF THE RAMP.

THE MAXIMUM RUNNING SLOPE OF 8.3% IS RELATIVE TO A FLAT (0%) REFERENCE. HOWEVER, IT SHALL NOT REQUIRE ANY RAMP OR SERIES OF RAMPS TO EXCEED 15 FEET IN LENGTH NOT INCLUDING LANDINGS OR TRANSITIONS.

DRAINAGE STRUCTURES SHOULD NOT BE PLACED IN LINE WITH RAMPS. THE LOCATION OF THE RAMP SHOULD TAKE PRECEDENCE OVER THE LOCATION OF THE DRAINAGE STRUCTURE. WHERE EXISTING DRAINAGE STRUCTURES ARE LOCATED IN THE RAMP PATH OF TRAVEL, USE A MANUFACTURER'S ADA COMPLIANT GRATE. OPENINGS SHALL NOT BE GREATER THAN 1/2". ELONGATED OPENINGS SHALL BE PLACED SO THAT THE LONG DIMENSION IS PERPENDICULAR TO THE DOMINANT DIRECTION OF TRAVEL.

THE TOP OF THE JOINT FILLER FOR ALL RAMP TYPES SHALL BE FLUSH WITH THE ADJACENT CONCRETE.

CROSSWALK AND STOP LINE MARKINGS, IF USED, SHALL BE SO LOCATED AS TO STOP TRAFFIC SHORT OF RAMP CROSSINGS. SPECIFIC DETAILS FOR MARKING APPLICATIONS ARE GIVEN IN THE "MICHIGAN MANUAL ON UNIFORM TRAFFIC CONTROL DEVICES".

FLARED SIDES WITH A SLOPE OF 10% MAXIMUM, MEASURED ALONG THE ROADSIDE CURB LINE, SHALL BE PROVIDED WHERE AN UNOBSTRUCTED CIRCULATION PATH LATERALLY CROSSES THE SIDEWALK RAMP. FLARED SIDES ARE NOT REQUIRED WHERE THE RAMP IS BORDERED BY LANDSCAPING, UNPAVED SURFACE OR PERMANENT FIXED OBJECTS. WHERE THEY ARE NOT REQUIRED, FLARED SIDES CAN BE CONSIDERED IN ORDER TO AVOID SHARP CURB RETURNS AT RAMP OPENINGS.

DETECTABLE WARNING PLATES MUST BE INSTALLED USING FABRICATED OR FIELD CUT UNITS CAST AND/OR ANCHORED IN THE PAVEMENT TO RESIST SHIFTING OR HEAVING.

MICHIGAN DEPARTMENT OF TRANSPORTATION
BUREAU OF DEVELOPMENT STANDARD PLAN FOR

**SIDEWALK RAMP AND
DETECTABLE WARNING DETAILS**

F.H.W.A. APPROVAL	7-26-2019 PLAN DATE	R-28-J	SHEET 7 OF 7
-------------------	------------------------	--------	-----------------

SYMBOL (B)

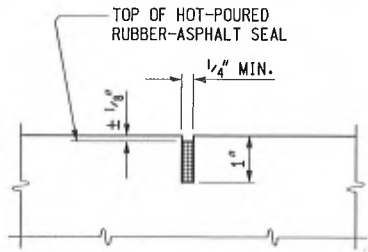

SAWED JOINT SEALED WITH HOT - Poured RUBBER - ASPHALT

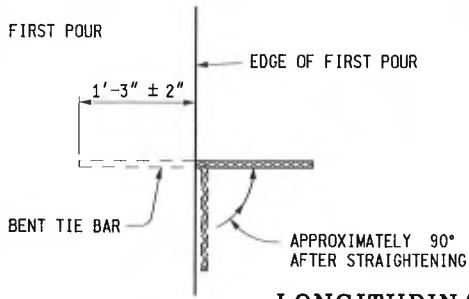

SURFACE OF FINISHED PAVEMENT

1/2 PAVEMENT THICKNESS ± 3/4"

BENT TIE BAR EPOXY COATED #5 DEFORMED BAR 2'-6" LONG (TYP.)

MAXIMUM ALLOWABLE LANE TIE SPACING (SPECIFIED BELOW)

LONGITUDINAL BULKHEAD JOINT - SYMBOL (B)

ALL SYMBOL (B) JOINTS SHALL BE SAWED AND SEALED EXCEPT JOINTS WITHOUT LANE TIES AND JOINTS ADJACENT TO VERTICAL FACES WHICH WOULD PROHIBIT SAWING.

SYMBOL (D) AND (S)

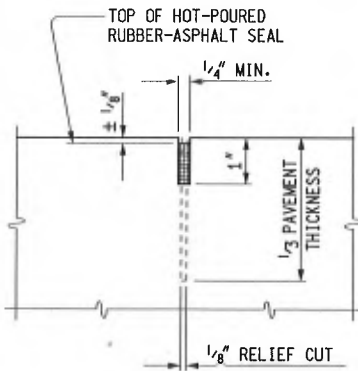

SAWED JOINT SEALED WITH HOT - Poured RUBBER - ASPHALT

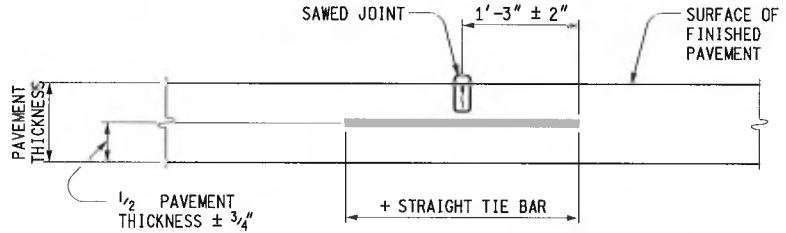

+ EPOXY COATED #5 DEFORMED BAR 2'-6" LONG FOR SYMBOL (D)
EPOXY COATED #5 SMOOTH BAR 2'-6" LONG FOR SYMBOL (S)
(MAXIMUM ALLOWABLE LANE TIE SPACING SPECIFIED BELOW)

LONGITUDINAL LANE TIE JOINT - SYMBOL (D)
LONGITUDINAL SMOOTH LANE TIE JOINT - SYMBOL (S)

SYMBOL (D) AND SYMBOL (S) TIE BARS SHALL BE PLACED AT THE PROPER SPACING LONGITUDINALLY, AND TRANSVERSELY AT 90° WITH THE JOINT.

MAXIMUM ALLOWABLE LANE TIE SPACING SYMBOLS (B), (D), (L2), AND (S)		* TOTAL DISTANCE OF TIED JOINT FROM NEAREST FREE EDGE
(B) GRADE 40	(D), (L2), AND (S) GRADE 60	
2'-10"	3'-7"	12' OR LESS
1'-11"	2'-7"	OVER 12' THROUGH 17'
1'-5"	1'-11"	OVER 17' THROUGH 24'
1'-2"	1'-9"	OVER 24' THROUGH 28'
1'-2"	1'-4"	OVER 28' THROUGH 36'
1'-1"	1'-1"	36' OR GREATER **

* INCLUDES ANY TIED COMBINATION OF LANE WIDTH, VALLEY GUTTER, CURB & GUTTER, OR SHOULDER
** FOR WIDTHS GREATER THAN 48' USE #6 DEFORMED BARS AT 1'-2" SPACING.

MAXIMUM ALLOWABLE LANE TIE SPACING



PREPARED BY DESIGN DIVISION

DRAWN BY: B.L.T.

CHECKED BY: W.K.P.

DEPARTMENT DIRECTOR
Kirk T. Stuedle

APPROVED BY: *Randy Van Pelt*
DIRECTOR, BUREAU OF FIELD SERVICES

APPROVED BY: *Neil A. Van Pelt*
DIRECTOR, BUREAU OF HIGHWAY DEVELOPMENT

MICHIGAN DEPARTMENT OF TRANSPORTATION
BUREAU OF HIGHWAY DEVELOPMENT STANDARD PLAN FOR

LONGITUDINAL PAVEMENT JOINTS

9-30-2014
F.H.W.A. APPROVAL

4-22-2013
PLAN DATE

R-41-H

SHEET 1 OF 2

SYMBOL (L2)

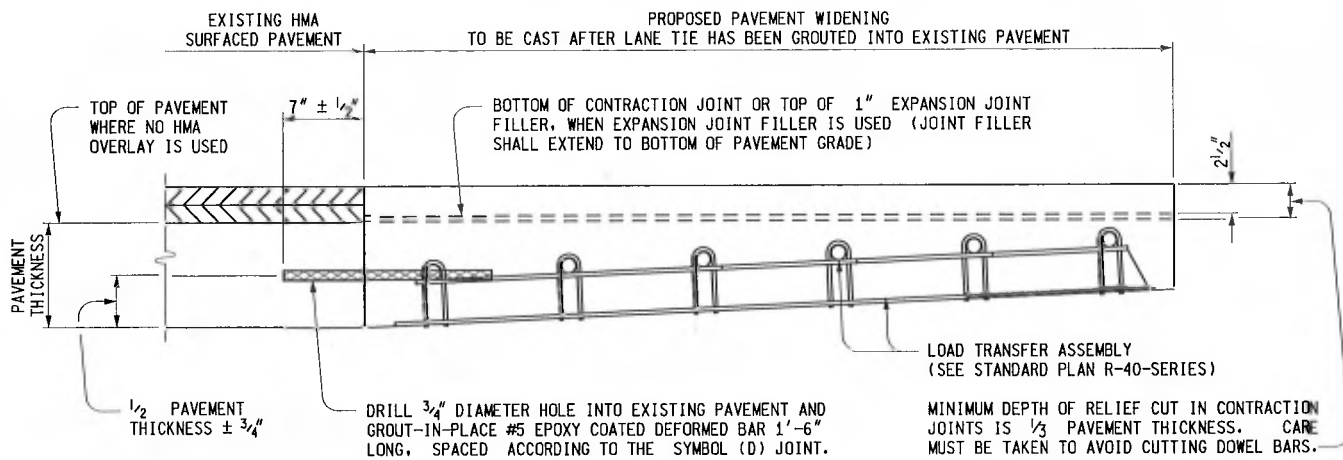

NOTE:
 SYMBOL (L2) JOINT USED FOR WIDENING CONCRETE PAVEMENTS WITHOUT HMA OVERLAYS SHALL BE SAWED AND SEALED ACCORDING TO THE SYMBOL (B) JOINT.

THE LONGITUDINAL JOINT USED FOR WIDENING EXISTING CONCRETE BASE COURSE OR CONCRETE PAVEMENT HAVING A HMA SURFACE SHALL HAVE EPOXY ANCHORED LANE TIES PLACED AS SPECIFIED.

TAPERED PAVEMENT THICKNESS OVER THE DISTANCE OF PAVEMENT WIDENING OR IN ONE LANE WIDTH WHEN WIDENING IS FOR TWO OR MORE LANES.

LONGITUDINAL BULKHEAD JOINT

FOR WIDENING EXISTING CONCRETE PAVEMENT OR CONCRETE BASE COURSE (USING EPOXY ANCHORED LANE TIES)

THE FIRST SLAB SHALL BE EDGED WITH AN EDGER HAVING A 3/4" LIP AND A RADIUS OF 1/8" TO 1/4" EDGING TOOL SHALL BE 6" x 12" AND SHALL HAVE A 1" LIP WITH A RADIUS OF 1/8" TO 1/4"



METHOD OF EDGING

NOTES:

ALL LANE TIE BARS SHALL BE DEFORMED EXCEPT SYMBOL (S) WHICH WILL BE SMOOTH.

THE EPOXY COATED S BARS ARE TO BE FACTORY COATED WITH AN APPROVED BOND RELEASE AGENT, UNIFORMLY APPLIED BY DIPPING AND WITHOUT EXCESSIVE DRIPS OR THICKNESS.

THE INSTALLATION OF LANE TIE BARS AND THE SAWING OF LONGITUDINAL JOINTS WILL NOT BE REQUIRED FOR TEMPORARY CONCRETE PAVEMENT UNLESS SPECIFIED ON PLANS OR IN THE PROPOSAL. THE EDGING OF TEMPORARY CONCRETE PAVEMENT WILL NOT BE REQUIRED.

FOR JOINT LAYOUT DETAILS, SEE STANDARD PLAN R-42-SERIES.

SAWING PROCEDURES AND RELATED OPERATIONS ARE DESCRIBED IN THE CURRENT STANDARD SPECIFICATIONS.

NO SAWED OR SEALED JOINT SHALL BE CONSTRUCTED BETWEEN THE PAVEMENT AND CURB OR PAVEMENT AND CURB AND GUTTER, WHERE THESE ITEMS ARE CAST INTEGRALLY.

WHEN JOINTED PLAIN CONCRETE IS SPECIFIED AT INTERSECTIONS SYMBOL (S) JOINTS ARE TO BE USED FOR THE LONGITUDINAL JOINT BETWEEN THE THE E2 JOINT AT THE SPRINGPOINT OF THE SIDE STREET AND THE THROUGH LANE GUTTER PAN LINE. WHEN THE E2 JOINT IS MOVED TO THE THROUGH LANE GUTTER PAN LINE USE SYMBOL (D) JOINT AS NORMALLY REQUIRED.

ALL STRAIGHT TIE BARS SHALL BE EPOXY COATED ACCORDING TO THE CURRENT STANDARD SPECIFICATIONS FOR EPOXY COATED STEEL REINFORCEMENT FOR STRUCTURES.

WHEN LANE TIES ARE GROUTED INTO AN EXISTING PAVEMENT, THE GROUT SHALL BE SELECTED FROM THE PREQUALIFIED MATERIALS LISTED IN THE DEPARTMENT'S "MATERIALS SAMPLING GUIDE" FOR LANE TIES.

IN ORDER TO AVOID CONFLICT WITH THE LOAD TRANSFER ASSEMBLY, THE PLACEMENT OF THE END LANE TIE ADJACENT TO ANY TRANSVERSE JOINT SHALL BE AS FOLLOWS:

1. WHEN MAXIMUM ALLOWABLE LANE TIE SPACING EXCEEDS 3'-4", PLACE FIRST AND LAST LANE TIE HALF THE MAXIMUM ALLOWABLE LANE TIE SPACING FROM JOINT.
2. WHEN MAXIMUM ALLOWABLE LANE TIE SPACING IS LESS THAN 3'-4", PLACE FIRST AND LAST LANE TIE A MINIMUM OF 1'-8" FROM JOINT.

IT MAY BE NECESSARY TO ADJUST THE LAST THREE LANE TIE SPACINGS TO ENSURE UNIFORM LOADING RESISTANCE ALONG THE LONGITUDINAL JOINT.







MICHIGAN DEPARTMENT OF TRANSPORTATION
 BUREAU OF HIGHWAY DEVELOPMENT STANDARD PLAN FOR

**LONGITUDINAL
 PAVEMENT JOINTS**

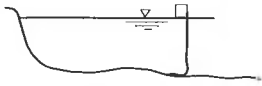
9-30-2014 F.H.W.A. APPROVAL	4-22-2013 PLAN DATE	R-41-H	SHEET 2 OF 2
--------------------------------	------------------------	--------	-----------------

APPLICABLE SOIL EROSION AND SEDIMENTATION CONTROL MEASURES
 (COMPREHENSIVE DETAILS ARE LOCATED IN SECTION 6 OF
 THE SOIL EROSION & SEDIMENTATION CONTROL MANUAL)

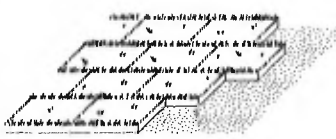
- A = SLOPES
- B = STREAMS AND WATERWAYS
- C = SURFACE DRAINAGEWAYS
- D = ENCLOSED DRAINAGE (INLET & OUTFALL CONTROL)
- E = LARGE FLAT SURFACE AREAS
- F = BORROW AND STOCKPILE AREAS
- G = DNRE PERMIT MAY BE REQUIRED

KEY	DETAIL	CHARACTERISTICS	A	B	C	D	E	F	G
1	 TURBIDITY CURTAIN	A Turbidity Curtain is used when slack water area is necessary to isolate construction activities from the watercourse. The still water area contains the sediments within the construction limits.		•					
2	 GRUBBING OMITTED	Retains existing root mat which assists in stabilizing slopes. Assists in the revegetation process by providing sprout growth. Reduces sheet flow velocities preventing rilling and gullyng. Discourages off-road vehicle use.		•			•		
3	 PERMANENT/TEMPORARY SEEDING	Inexpensive but effective erosion control measure to stabilize flat areas and mild slopes. Permits runoff to infiltrate soil, reducing runoff volumes. Proper preparation of the seed bed, fertilizing, mulching and watering is critical to its success.		•	•		•	•	
4	 DUST CONTROL	Dust control can be accomplished by watering, and/or applying calcium chloride. The disturbed areas should be kept to a minimum. PERMANENT/TEMPORARY SEEDING (KEY 3) should be applied as soon as possible.		•			•	•	
5	 SODDING	Provides immediate vegetative cover such as at spillways and ditch bottoms. Proper preparation of the topsoil, placement of the sod, and watering is critical to its success.		•			•	•	
6	 VEGETATED BUFFER STRIPS	Reduces sheet flow velocities preventing rilling and gullyng. Assists in the collection of sediments by filtering runoff. Assists in the establishment of a permanent vegetative cover.		•			•		

MDOT
Michigan Department of Transportation

PREPARED BY
DESIGN DIVISION

DRAWN BY: B.L.T.

CHECKED BY: W.K.P.

DEPARTMENT DIRECTOR
Kirk T. Steudle







APPROVED BY: John C. Friend
ENGINEER OF DELIVERY

APPROVED BY: Maui A. Van Pelt
ENGINEER OF DEVELOPMENT

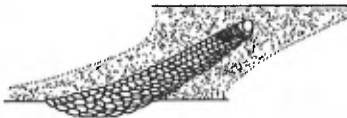
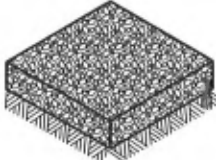
MICHIGAN DEPARTMENT OF TRANSPORTATION
BUREAU OF HIGHWAY DEVELOPMENT STANDARD PLAN FOR

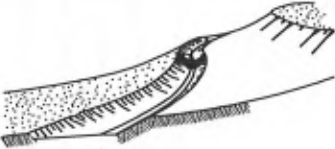
SOIL EROSION & SEDIMENTATION CONTROL MEASURES

9-10-2010 F.H.W.A. APPROVAL	6-3-2010 PLAN DATE	R-96-E	SHEET 1 OF 6
--------------------------------	-----------------------	---------------	-----------------

KEY	DETAIL	CHARACTERISTICS	A	B	C	D	E	F	G
7	 <p>RIPRAP</p>	Used where vegetation cannot be established. Very effective in protecting against high velocity flows. Should be placed over a geotextile liner.	•	•	•	•			•
8	 <p>AGGREGATE COVER</p>	Can be used in any area where a stable condition is needed for construction operations, equipment storage or in heavy traffic areas. Reduces potential soil erosion and fugitive dust by stabilizing raw areas.	•				•	•	
9	 <p>BENCHES</p>	Reduces sheet flow velocities preventing rilling and gullyng. Assists in the collection and filtering of sediments. Provides access for stabilizing slopes.	•					•	
10	 <p>DIVERSION DIKE</p>	Assists in the diversion of runoff to a stable outlet or sediment control device. Reduces sheet flow velocities preventing rilling and gullyng. Collects and diverts runoff to properly stabilized drainage ways. Works well with INTERCEPTING DITCH (KEY 11)	•				•	•	
11	 <p>INTERCEPTING DITCH</p>	Assists in the diversion of runoff to a stable outlet or sediment control device. Reduces sheet flow velocities preventing rilling and gullyng. Works well with DIVERSION DIKE (KEY 10)	•				•	•	
12	 <p>INTERCEPTING DITCH AND DIVERSION DIKE</p>	Assists in the diversion of runoff to a stable outlet or sediment control device. Reduces sheet flow velocities preventing rilling and gullyng.	•				•	•	
13	 <p>GRAVEL FILTER BERM</p>	Useful in filtering flow prior to its reentry into a lake, stream or wetland. Works well with SEDIMENT TRAP (KEY 20) and TEMPORARY BYPASS CHANNEL (KEY 35). Not to be used in lieu of a CHECK DAM (KEY 37) in a ditch.	•		•			•	
14	 <p>GRAVEL ACCESS APPROACH</p>	Provides a stable access to roadways minimizing fugitive dust and tracking of materials onto public streets and highways.						•	•

MICHIGAN DEPARTMENT OF TRANSPORTATION
BUREAU OF HIGHWAY DEVELOPMENT STANDARD PLAN FOR









**SOIL EROSION & SEDIMENTATION
CONTROL MEASURES**

9-10-2010
F.H.W.A. APPROVAL

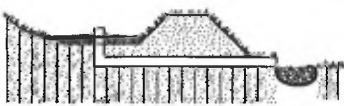
6-3-2010
PLAN DATE

R-96-E

SHEET
2 OF 6

KEY	DETAIL	CHARACTERISTICS	A	B	C	D	E	F	G
15	 <p>SLOPE DRAIN SURFACE</p>	<p>Excellent device for carrying water down slopes without creating an erosive condition.</p> <p>Generally used in conjunction with DIVERSION DIKE (KEY 10), INTERCEPTING DITCH (KEY 11) and INTERCEPTING DITCH AND DIVERSION DIKE (KEY 12) to direct flow to a stable discharge area or SEDIMENT TRAP (KEY 20).</p>		•		•			
16	 <p>TREES, SHRUBS AND PERENNIALS</p>	<p>Trees, shrubs and perennials can provide low maintenance long term erosion protection. These plants may be particularly useful where site aesthetics are important along the roadside slopes.</p>		•				•	
17	 <p>PIPE DROP</p>	<p>Effective way to allow water to drop in elevation very rapidly without causing an erosive condition.</p> <p>Also works as a sediment collector device.</p> <p>May be left in place as a permanent erosion control device.</p>		•		•			
18	 <p>DEWATERING WITH FILTER BAG</p>	<p>It may be necessary to dewater from behind a cofferdam or construction dam to create a dry work site.</p> <p>Discharged water must be pumped to a filter bag.</p> <p>A GRAVEL FILTER BERM (KEY 13) may be placed downslope of the filter bag to provide additional filtration prior to entering any stream or wetland.</p>			•				•
19	 <p>ENERGY DISSIPATORS</p>	<p>A device to prevent the erosive force of water from eroding soils.</p> <p>Used at outlets of culverts, drainage pipes or other conduits to reduce the velocity of the water.</p> <p>Prevents structure scouring and undermining.</p>		•	•	•	•		
20	 <p>SEDIMENT TRAP</p>	<p>Used to intercept concentrated flows and prevent sediments from being transported off site or into a watercourse or wetland.</p> <p>The size of a Sediment Trap is 5 cubic yards or less.</p> <p>Works well when used with CHECK DAM (KEY 37).</p>		•		•	•		
21	 <p>SEDIMENT BASIN</p>	<p>A Sediment Basin is used to trap sediments from an upstream construction site.</p> <p>Requires periodic inspections, repairs, and maintenance.</p> <p>Where practical, sediments should be contained on site.</p> <p>A Sediment Basin should be the last choice of sediment control.</p> <p>The size of a Sediment Basin is greater than 5 cubic yards.</p>			•				•
22	 <p>VEGETATIVE BUFFER AT WATERCOURSE</p>	<p>This practice is used to maintain a vegetative buffer adjacent to a watercourse.</p> <p>When utilized with SILT FENCE (KEY 26) it will, under normal circumstances, prevent sediment from leaving the construction site.</p>		•	•	•		•	•

MICHIGAN DEPARTMENT OF TRANSPORTATION
BUREAU OF HIGHWAY DEVELOPMENT STANDARD PLAN FOR



**SOIL EROSION & SEDIMENTATION
CONTROL MEASURES**

9-10-2010
F.H.W.A. APPROVAL

6-3-2010
PLAN DATE

R-96-E

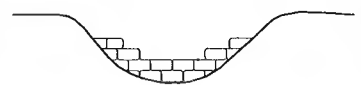
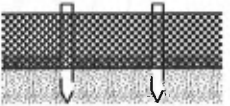
SHEET
3 OF 6

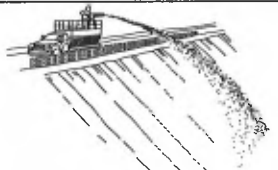
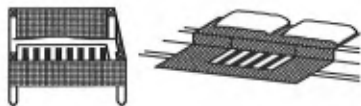
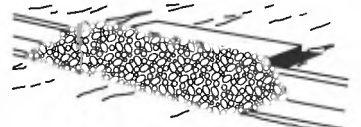
KEY	DETAIL	CHARACTERISTICS	A	B	C	D	E	F	G
23	 <p style="text-align: center;">STREAM RELOCATION</p>	<p>A detail depicting the proper procedures for stream relocation. Maintains same width, depth, and flow velocity as the natural stream. Revegetate banks with PERMANENT/TEMPORARY SEEDING (KEY 3), MULCHING AND MULCH ANCHORING (KEY 28), MULCH BLANKETS AND HIGH VELOCITY MULCH BLANKETS (KEY 33) and woody plants to shade the stream.</p>			•				•
24	 <p style="text-align: center;">SAND AND STONE BAGS</p>	<p>Sand and stone bags are a useful tool in the prevention of erosion. Can be used to divert water around a construction site by creating a DIVERSION DIKE (KEY 10). Works well for creating a CONSTRUCTION DAM (KEY 36) and temporary culvert end fill.</p>	•	•	•	•	•	•	•
25	 <p style="text-align: center;">SAND FENCE AND DUNE STABILIZATION</p>	<p>A Sand Fence traps blowing sand by reducing wind velocities. Can be used to prevent sand from blowing onto roads. Must be maintained until sand source is stabilized.</p>	•				•	•	
26	 <p style="text-align: center;">SILT FENCE</p>	<p>A permeable barrier erected below disturbed areas to capture sediments from sheet flow. Can be used to divert small volumes of water to stable outlets. Ineffective as a filter and should never be placed across streams or ditches where flow is concentrated.</p>	•				•	•	
27	 <p style="text-align: center;">PLASTIC SHEETS OR GEOTEXTILE COVER</p>	<p>Plastic Sheets can be used to create a liner in temporary channels. Can also be used to create a temporary cover to prevent erosion of stockpiled materials.</p>	•	•	•			•	
28	 <p style="text-align: center;">MULCHING AND MULCH ANCHORING</p>	<p>Anchored mulch provides erosion protection against rain and wind. Mulch must be used on seeded areas to promote water retention and growth. Should be inspected after every rainstorm and repaired as necessary until vegetation is well established.</p>	•		•		•	•	
29	 <p style="text-align: center;">INLET PROTECTION FABRIC DROP</p>	<p>Provides settling and filtering of silt laden water prior to its entry into the drainage system. Can be used in median and side ditches where vegetation will be disturbed. Allows for early use of drainage systems prior to project completion.</p>			•		•		
30	 <p style="text-align: center;">INLET PROTECTION GEOTEXTILE AND STONE</p>	<p>Provides settling and filtering of silt laden water prior to its entry into the drainage system. Should be used in paved areas where drainage structures are existing or proposed. Allows for early use of drainage systems prior to project completion.</p>			•		•		

MICHIGAN DEPARTMENT OF TRANSPORTATION
BUREAU OF HIGHWAY DEVELOPMENT STANDARD PLAN FOR







SOIL EROSION & SEDIMENTATION CONTROL MEASURES

9-10-2010
F.H.W.A. APPROVAL

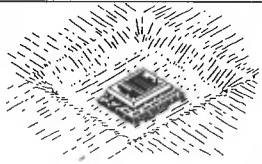
6-3-2010
PLAN DATE

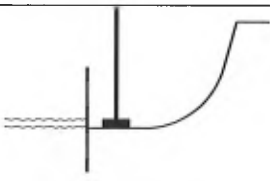
R-96-E

SHEET
4 OF 6

KEY	DETAIL	CHARACTERISTICS	A	B	C	D	E	F	G
31	 <p>INLET PROTECTION SEDIMENT TRAP</p>	<p>An Inlet Protection Sediment Trap is a temporary device that can be used in areas where medium flows are anticipated. Effective in trapping small quantities of sediments prior to water entering the drainage system. Can be used in areas such as median and side ditches.</p>			•		•		
32	 <p>SLOPE ROUGHENING AND SCARIFICATION</p>	<p>A simple and economical way to reduce soil erosion by wind and water. Can be accomplished by harrowing with a disk, back blading, or tracking with a dozer perpendicular to the slope.</p>	•				•	•	
33	 <p>MULCH BLANKETS AND HIGH VELOCITY MULCH BLANKETS</p>	<p>Mulch blankets provide an immediate and effective cover over raw erodible slopes affording excellent protection against rain and wind erosion. High velocity mulch blankets work well for stabilizing the bottom of ditches in waterways.</p>	•		•		•	•	
34	 <p>COFFERDAM</p>	<p>Used to create a dry construction area and protect the stream from raw erodible areas. Must be pumped dry or dewatered according to DEWATERING WITH FILTER BAG (KEY 18).</p>		•					•
35	 <p>TEMPORARY BYPASS CHANNEL</p>	<p>Utilized when a dry construction area is needed. Isolates stream flows from raw erodible areas minimizing erosion and subsequent siltation. Can incorporate SEDIMENT BASIN (KEY 21), CHECK DAM (KEY 37), and GRAVEL FILTER BERM (KEY 13) to remove sediments from water. Construction sequence of events may be necessary.</p>		•					•
36	 <p>CONSTRUCTION DAM</p>	<p>Used to create a dry or slack water area for construction. Isolates the stream from raw erodible areas. Can be created out of any non-erodible materials such as SAND AND STONE BAGS (KEY 24), a gravel dike with clay core or plastic liner, steel plates or plywood.</p>		•					•
37	 <p>CHECK DAM</p>	<p>Can be constructed across ditches or any area of concentrated flow. Protects vegetation in early stages of growth. A Check Dam is intended to reduce water velocities and capture sediment. A Check Dam is not a filtering device.</p>	•		•			•	

NOTES:

THIS STANDARD PLAN WILL SERVE AS A KEY IN THE SELECTION OF THE APPROPRIATE SOIL EROSION AND SEDIMENTATION CONTROL DETAILS. THIS PLAN ALSO PROVIDES THE KEY TO THE NUMBERED EROSION CONTROL ITEMS SPECIFIED ON THE CONSTRUCTION PLANS. REFER TO THE MDOT SOIL EROSION & SEDIMENTATION CONTROL MANUAL, SECTION 6 FOR SPECIFIC DETAILS, CONTRACT ITEMS (PAY ITEMS), AND PAY UNITS.

COLLECTED SILT AND SEDIMENT SHALL BE REMOVED PERIODICALLY TO MAINTAIN THE EFFECTIVENESS OF THE SEDIMENT TRAP, SEDIMENT BASIN, AND SILT FENCE. AGGREGATES PLACED IN STREAMS SHOULD CONTAIN A MINIMUM OF FINES.

TEMPORARY EROSION AND SEDIMENTATION CONTROL PROVISIONS SHALL BE COORDINATED WITH THE PERMANENT CONTROL MEASURES TO ASSURE EFFECTIVE CONTROL OF SEDIMENTS DURING CONSTRUCTION OF THE PROJECT.

ALL TEMPORARY EROSION CONTROL DEVICES SHALL BE REMOVED AFTER VEGETATION ESTABLISHMENT OR AT THE DISCRETION OF THE ENGINEER. CARE SHALL BE TAKEN DURING REMOVAL TO MINIMIZE SILTATION IN NEARBY DRAINAGE COURSES.

MICHIGAN DEPARTMENT OF TRANSPORTATION
BUREAU OF HIGHWAY DEVELOPMENT STANDARD PLAN FOR

SOIL EROSION & SEDIMENTATION
CONTROL MEASURES

9-10-2010
F.H.W.A. APPROVAL

6-3-2010
PLAN DATE

R-96-E

SHEET
6 OF 6

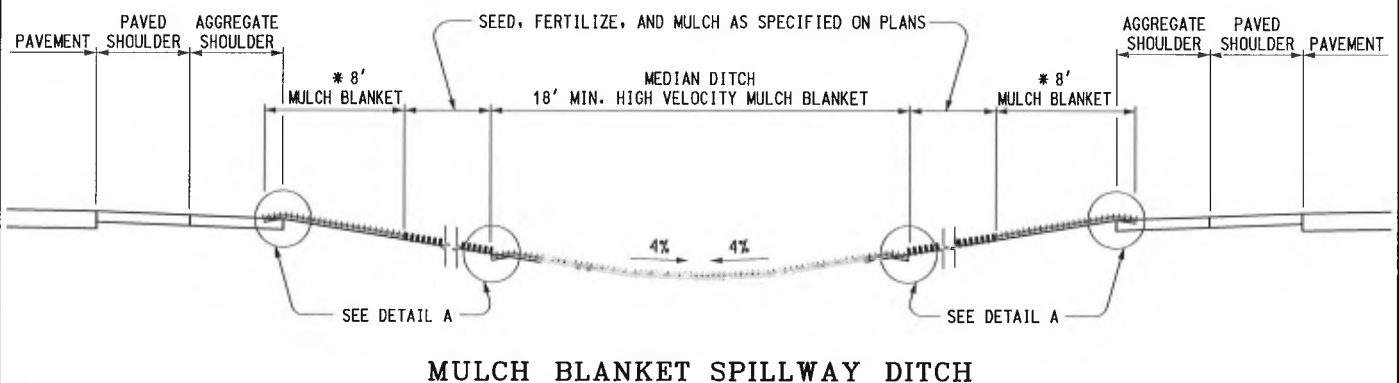
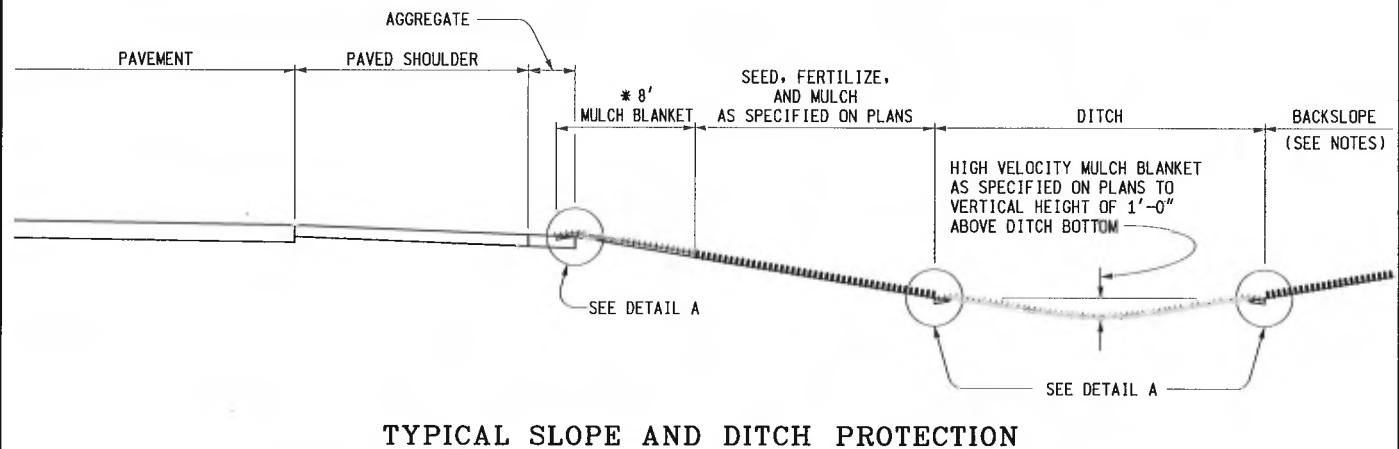
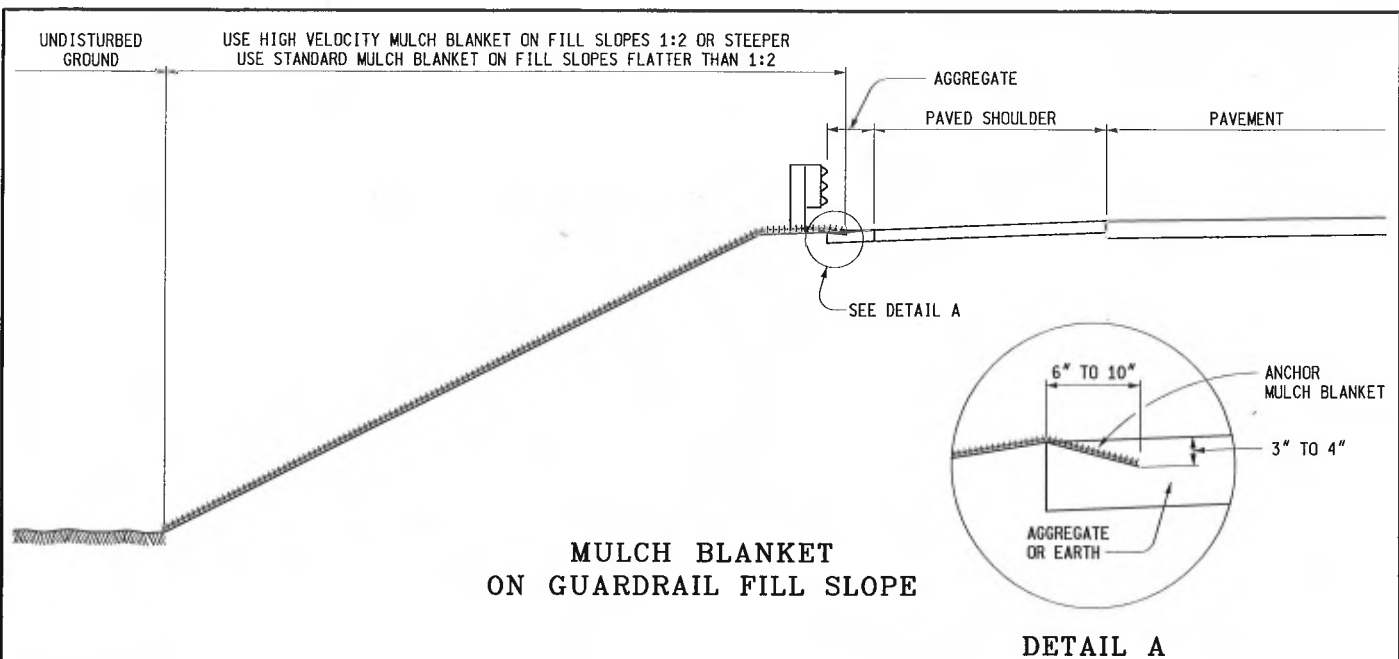

* NOTE:

MULCH BLANKET SHALL BE USED ON BOTH SIDES OF NORMAL SECTIONS, HIGH SIDES OF ALL SUPERELEVATED SECTIONS, AND LOW SIDES OF PAVEMENTS HAVING A SUPERELEVATION OF 5% OR LESS. HIGH VELOCITY MULCH BLANKET SHALL BE USED ON THE LOW SIDE OF PAVEMENTS HAVING A RATE OF SUPERELEVATION GREATER THAN 5%.



PREPARED BY
DESIGN DIVISION

DRAWN BY: B.L.T.

CHECKED BY: W.K.P.

DEPARTMENT DIRECTOR
Kirk T. Stuehle

APPROVED BY:

Randy Van Pelt
DIRECTOR, BUREAU OF FIELD SERVICES

APPROVED BY:

Mark A. Van Pelt
DIRECTOR, BUREAU OF HIGHWAY DEVELOPMENT

MICHIGAN DEPARTMENT OF TRANSPORTATION
BUREAU OF HIGHWAY DEVELOPMENT STANDARD PLAN FOR

**SEEDING
AND TREE PLANTING**

9-30-2014
F.H.W.A. APPROVAL

9-26-2013
PLAN DATE

R-100-H

SHEET
1 OF 4

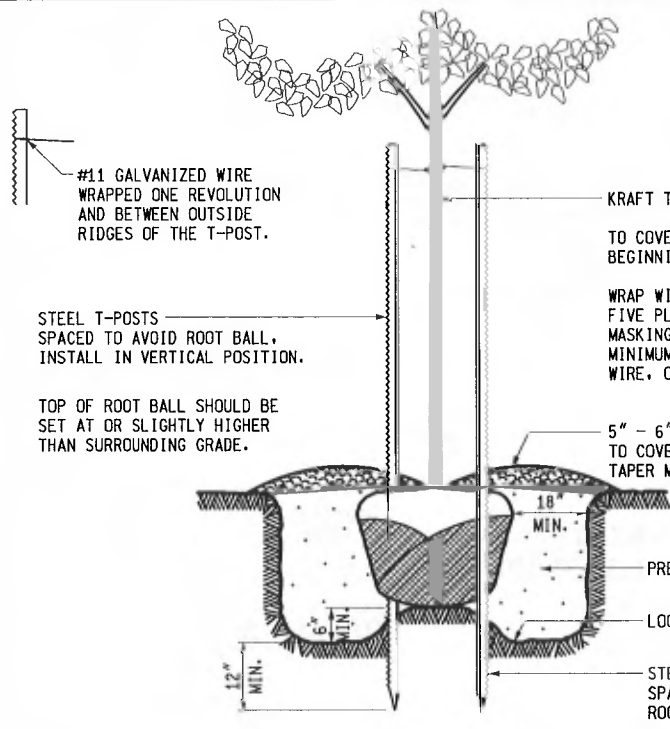

KRAFT TREE WRAP
TO COVER TRUNKS OF ALL DECIDUOUS TREES, BEGINNING BELOW SOIL LINE JUST ABOVE ROOTS.
WRAP WITH MINIMUM 2" WIDE MASKING TAPE IN FIVE PLACES, INCLUDING TOP & BOTTOM OF WRAPPING. MASKING TAPE SHALL BE WRAPPED AROUND TREE A MINIMUM OF TWO TIMES EACH PLACE. USE OF TWINE, WIRE, OR DUCT TAPE WILL NOT BE ALLOWED.

5" - 6" MULCH TO COVER ENTIRE PLANTING HOLE. TAPER MULCH TO TRUNK.

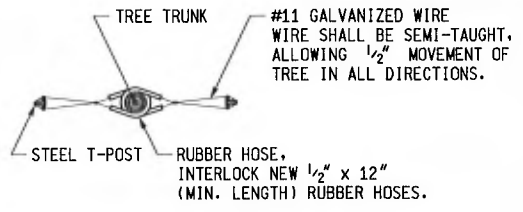

BRACING - VERTICAL STAKES

BRACING DETAIL

BRACE DECIDUOUS TREES 2" TO 4" IN CALIPER OR 8' OR MORE IN HEIGHT WITH TWO STAKES.

BRACE DECIDUOUS TREES LESS THAN 2" IN CALIPER OR 8' IN HEIGHT WITH ONE STAKE ON THE WESTERLY SIDE OF THE PLANT.

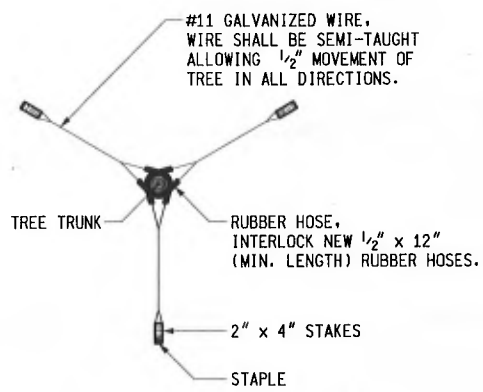

TRIPOD GUYING DETAIL

GUY EVERGREENS OVER 4" IN CALIPER OR 6' IN HEIGHT WITH THE TRIPOD METHOD AND UNDER 6' IN HEIGHT WITH TWO STAKES.

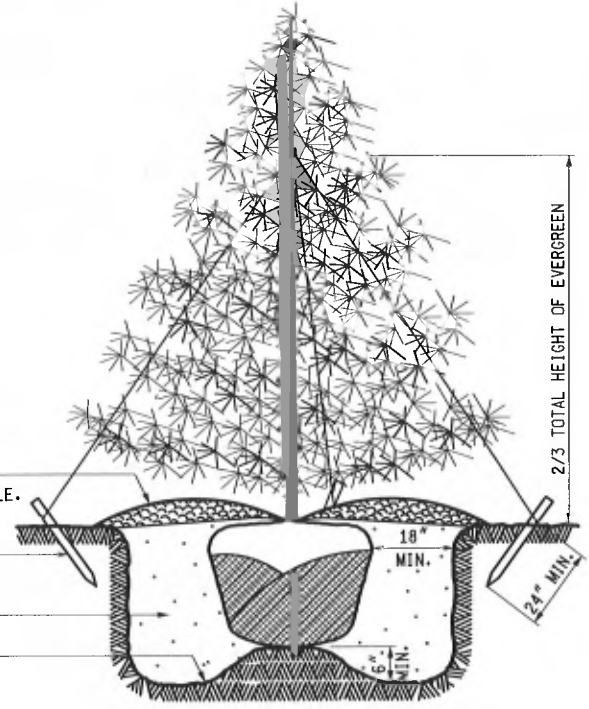

GUYING - TRIPOD METHOD

5" - 6" MULCH TO COVER ENTIRE PLANTING HOLE. TAPER MULCH TO TRUNK.
NOTCHED STAKE IN UNDISTURBED SOIL
PREPARED SOIL
LOOSEN SUBSOIL

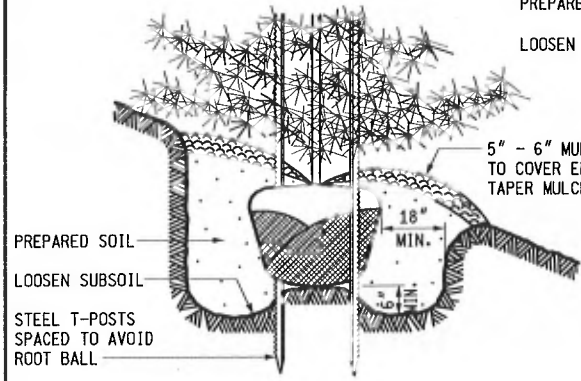

SLOPE PLANTING

MICHIGAN DEPARTMENT OF TRANSPORTATION
BUREAU OF HIGHWAY DEVELOPMENT STANDARD PLAN FOR

**SEEDING
AND TREE PLANTING**

9-30-2014 F.H.W.A. APPROVAL	9-26-2013 PLAN DATE	R-100-H	SHEET 2 OF 4
--------------------------------	------------------------	---------	-----------------

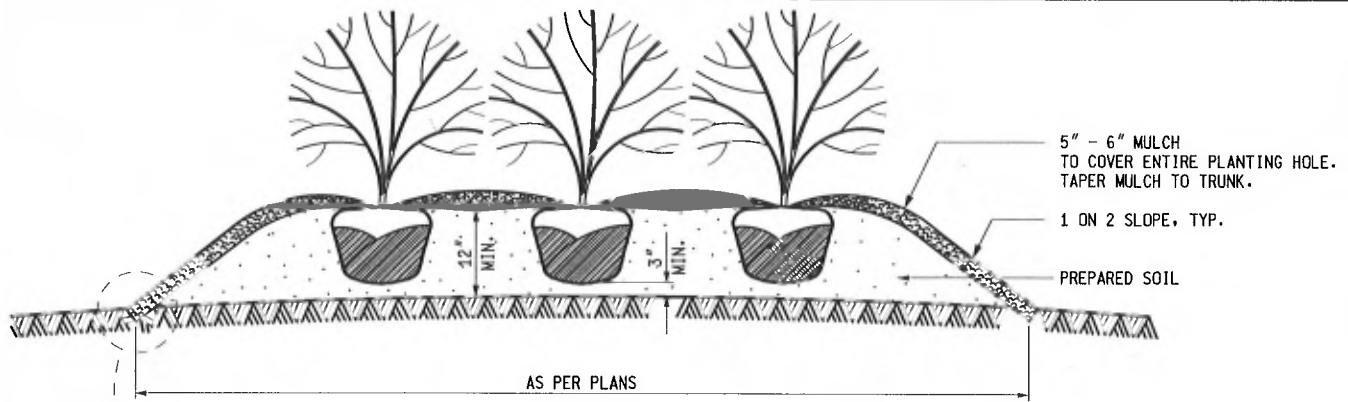

AS PER PLANS

RAISED SHRUB BED DETAIL

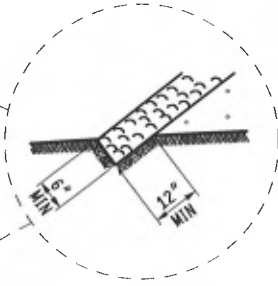

SHRUB BED EDGING DETAIL

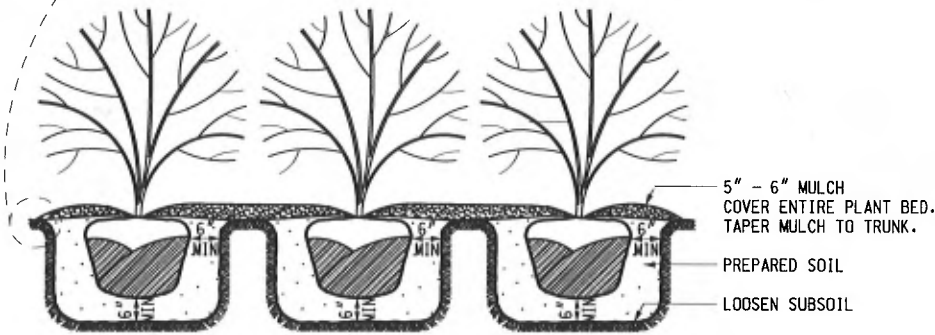

SHRUB BED DETAIL

FIRST AND SECOND WATERING AND CULTIVATION SHALL INCLUDE SHRUB BEDS.

CUT 6" X 12" (MIN.) EDGING AROUND THE PERIMETER OF ALL SHRUB BEDS SHOWN ON THE PLANS. SPRAY A NON-PERSISTANT GLYPHOSATE HERBICIDE TO ENTIRE SHRUB BEDS PRIOR TO PLANTING AND BARK PLACEMENT.

SHRUB BEDS ARE TO BE PAID FOR BY THE PAY ITEM 'SITE PREPARATION'.

ALL PLANTS SHALL BE SET PLUMB AND HAVE THE BEST SIDE OF PLANT FACING THE MAIN VIEWING DIRECTION.

PLANTING NOTES:

ALL EXCAVATED MATERIAL SHALL BE REMOVED FROM THE SITE - IMMEDIATELY.

LOOSEN SUBSOIL TO A DEPTH OF 4". LOOSEN EARTH ON SIDES OF PLANT POCKET TO BREAK ANY GLAZING CAUSED BY DIGGING.

FILL PREPARED SOIL TO 1/2 THE DEPTH OF THE ROOT BALL, PACK FIRMLY, AND PUDDLE WITH WATER.

BACKFILL WITH PREPARED SOIL WHICH, AFTER COMPACTION, IS FLUSH WITH SURROUNDING GROUND LEVEL.

COVER ENTIRE PLANT POCKET AREA WITH 5"-6" MULCH. PRUNE, WRAP, AND BRACE AND GUY.

WHEN PLANTS ARE FURNISHED IN CONTAINERS, CONTAINERS SHALL BE COMPLETELY REMOVED AT THE TIME OF PLANTING.

TREE HEIGHTS ARE SHOWN BEFORE PRUNING. TREE PLANTING DEPTHS ARE SHOWN AFTER SETTLING.

TREES AND SHRUBS SHALL NOT BE PLANTED WITHIN 50' AND 30' RESPECTIVELY OF THE NEAREST EDGE OF METAL - EXCEPT WHERE INACCESSIBLE TO VEHICLES.

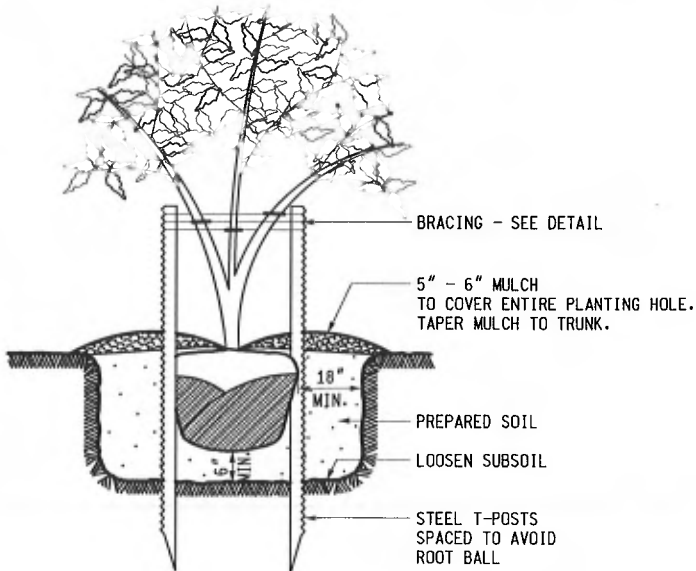

MULTIPLE STEM TREES

MICHIGAN DEPARTMENT OF TRANSPORTATION
BUREAU OF HIGHWAY DEVELOPMENT STANDARD PLAN FOR

**SEEDING
AND TREE PLANTING**

9-30-2014
F.H.W.A. APPROVAL

9-26-2013
PLAN DATE

R-100-H

SHEET
3 OF 4

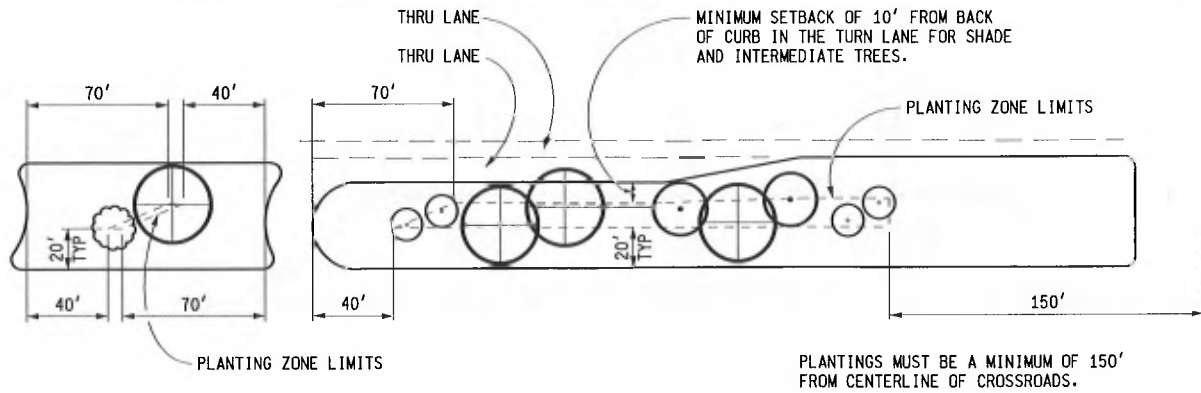

PLANTINGS MUST BE A MINIMUM OF 150' FROM CENTERLINE OF CROSSROADS.

MEDIAN PLANTING
NOT TO SCALE

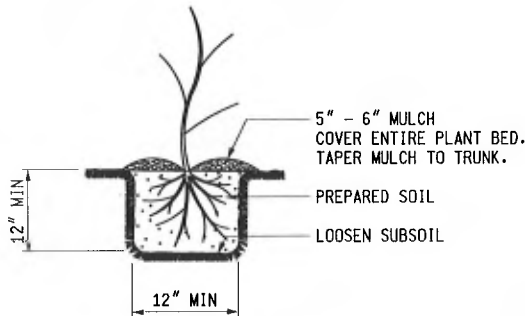

BARE ROOT PLANTS

PLANTING BARE ROOT PLANT MATERIAL

REFER TO THE "SPECIAL PROVISIONS FOR BARE ROOT PLANTING" FOR SHIPPING, STORAGE AND HANDLING REQUIREMENTS.
MAINTAIN ROOT MOISTURE BY KEEPING ROOTS IMMERSSED IN WATER PRIOR TO PLANTING.

ROOT PRUNE AS NECESSARY TO REMOVE ALL DAMAGED OR BROKEN ROOTS, AND AS REQUIRED BY THE DISTRICT FORESTER OR RESOURCE SPECIALIST.

DIG PLANTING HOLES AT LEAST 12" WIDE AND 12" DEEP TO ACCOMMODATE ROOT MASS.

SET PLANTS PLUMB WITH THE ROOTS SPREAD PUT IN A NATURAL POSITION AT A DEPTH EQUAL TO THE DEPTH AT THE NURSERY.

HOLD PLANT FIRMLY AND PUDDLE (NOT TAMP) THE BACKFILL AROUND THE ROOTS WITH WATER. SUFFICIENT WATER SHALL BE USED TO ENSURE SATURATION OF THE BACKFILL, BUT CARE SHOULD BE TAKEN NOT TO OVERWATER, CAUSING A FLOATING SOIL MASS THAT PREVENTS COMPACTION AND MAY RESULT IN AIR POCKETS ADJACENT TO THE ROOTS. BACKFILL SHOULD BE FLUSH WITH THE GROUND AFTER COMPACTION.

COVER ENTIRE PLANT POCKET AREA WITH 5" - 6" MULCH AS SHOWN.

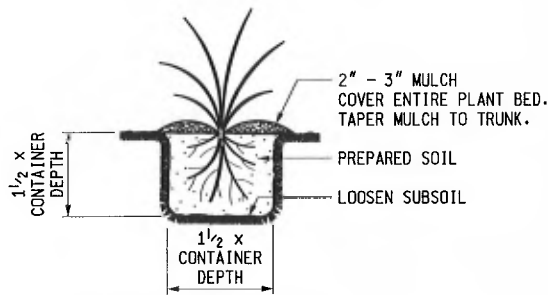

PERENNIAL PLANTS

FIRST AND SECOND WATERING AND CULTIVATION SHALL INCLUDE PERENNIAL BEDS.
PERENNIALS ARE TO BE FULLY DEVELOPED TWO YEAR #2 CONTAINER PLANTS.
ENTIRE PERENNIAL BED SHALL BE EXCAVATED DOWN 12" AND REPLACED WITH 12" OF PREPARED SOIL.
PERENNIAL BEDS ARE TO BE PAID FOR BY THE PAY ITEM 'SITE PREPARATION'.

SEEDING NOTES:

THIS STANDARD ILLUSTRATES THE TYPICAL USE OF SEEDING WITH MULCH, AS THESE ITEMS RELATE TO ROADWAY CONSTRUCTION. THE ACTUAL DESIGN AND MATERIALS USED TO CONSTRUCT THE COMPLETE SECTION, WHICH INCLUDES SEEDING WITH MULCHING, WILL BE ACCORDING TO THE PLANS AND CURRENT SPECIFICATIONS.

ITEMS CALLED FOR ON THIS STANDARD MAY ALSO BE USED DURING CONSTRUCTION AS AN EROSION CONTROL MEASURE. SEE STANDARD PLAN R-96-SERIES.

ALL DITCHES SHOULD HAVE HIGH VELOCITY MULCH BLANKET FOR EROSION CONTROL.

THE FIRST 6' BEHIND THE CURB OR SHOULDER IN URBAN MEDIAN AREAS WILL BE SEEDED, FERTILIZED, AND MULCHED WITH MULCH BLANKET. THE REMAINING AREAS WILL BE SEEDED, FERTILIZED, AND MULCHED WITH MULCH BLANKET OR STANDARD MULCH ANCHORED IN PLACE WITH A MULCH ADHESIVE OR WITH A MULCH NET.

ALL AREAS WHERE MULCH BLANKET IS CALLED FOR SHALL BE SEEDED, FERTILIZED, AND TOPSOILED AS SPECIFIED ON PLANS. NO MULCH OR ANCHORING MULCH IS REQUIRED WHERE MULCH BLANKET IS INSTALLED.

BACKSLOPE RESTORATION TREATMENT SHALL BE THE SAME AS THE FRONT SLOPE.

MICHIGAN DEPARTMENT OF TRANSPORTATION
BUREAU OF HIGHWAY DEVELOPMENT STANDARD PLAN FOR

**SEEDING
AND TREE PLANTING**

9-30-2014 F.H.W.A. APPROVAL	9-26-2013 PLAN DATE	R-100-H	SHEET 4 OF 4
--------------------------------	------------------------	---------	-----------------

<u>TYPE OF CASTING</u>	<u>NEEHAH FOUNDRY</u>	<u>EAST JORDAN IRON WORKS</u>
Barrier Curb Inlet	R-3013B, Type S grate (500 Pounds)	7045, Type M1 grate (490 Pounds)
Barrier Curb Double Inlet	R-3249F, Type S grate (410 Pounds)	N/A
Mountable Curb Inlet	R-3034B, Type S grate (500 Pounds)	7065, Type M1 grate (470 Pounds)
Gutter Inlet	R-3448C, Type S grate (285 Pounds)	5080, Type M2 grate (315 Pounds)
Gutter Double Inlet	R-3448B, Type S grate (265 Pounds)	5000, Type M2 grate (285 Pounds)
Yard Drain	R-2560-E1 (285 Pounds)	1040, Type 02 grate (355 Pounds)
Yard Drain in City Park	N/A	1040, Type M1 grate (400 Pounds)
*Manhole Frame & Cover (Water and Storm)	R-1642, Type C Cover (380 Pounds)	1040, Type A Cover (400 Pounds)
**Watertight Manhole Frame and Cover (Sanitary)	N/A	1040, Type AGS Cover (400 Pounds)
Monument Box	N/A	8360 (100 Pounds)

*Frames and covers must have machined bearing surfaces.

**Manhole covers shall be labeled with "CITY OF ANN ARBOR" and "WATER", "STORM" or "SANITARY", whichever is applicable. All covers shall include the City's custom logo in use at the time of the project.

***Sanitary manhole covers shall be 1040AGS with a 1/4" neoprene gasket to seal against the frame.

REVISIONS		REV. NO.	DR. BY	CH. BY
PUBLIC SERVICES DEPARTMENT CITY OF ANN ARBOR				
STANDARD CASTING SCHEDULE				
DR. BY	JPB	CH. BY	CSS	DRAWING NO.
SCALE	NONE	DATE	6-12-92	SD-GU-5
INCH				SHEET NO. _____ OF _____

WATER OR GAS VALVE BOX ADJUSTMENT

NOTE: GAS VALVE BOXES TO BE ADJUSTED BY THE GAS COMPANY.

MONUMENT BOX ADJUSTMENT

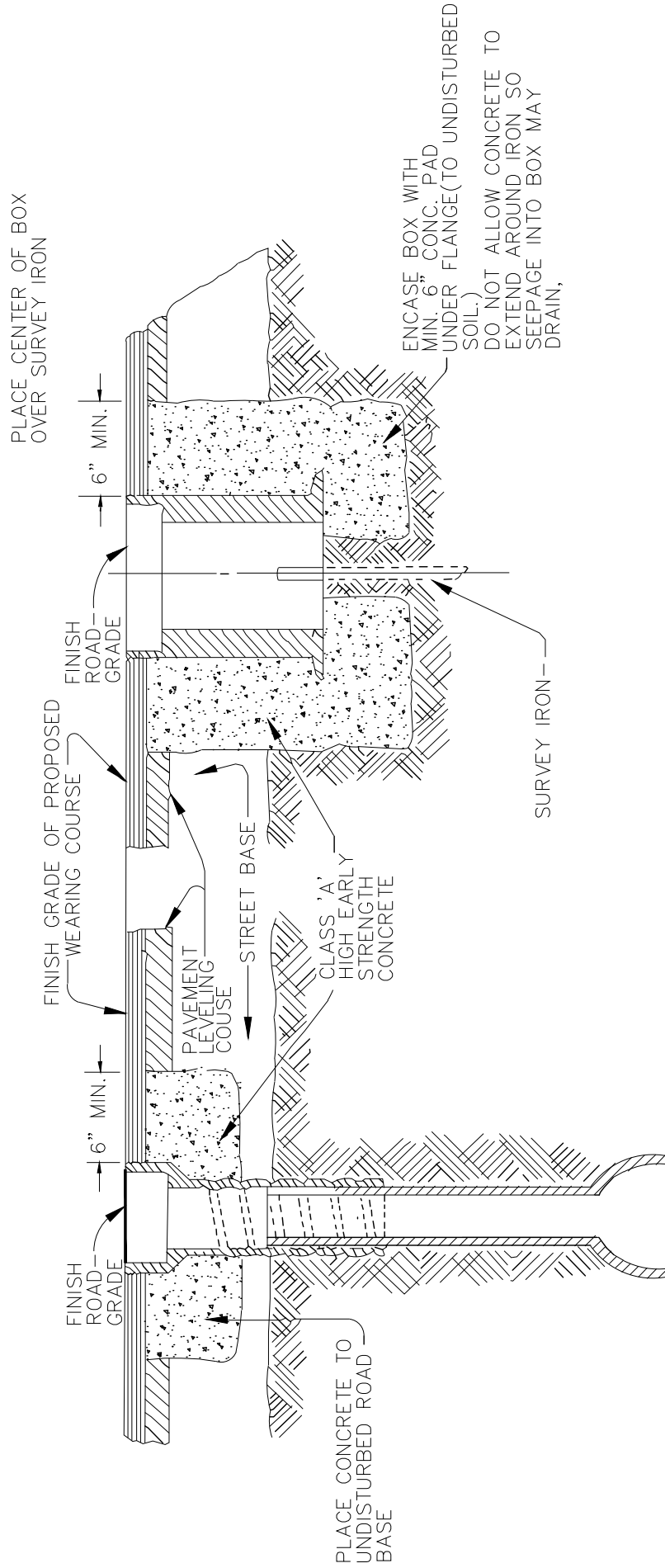

NOTE: RAISE CASTING TO PROPOSED FINISH STREET GRADE AFTER PLACEMENT OF LEVELING COURSE(S) AND PRIOR TO PLACING FINAL SURFACE COURSE

REVISIONS	REV. NO.	DR. BY	CH. BY	DATE
PUBLIC SERVICES DEPARTMENT				
CITY OF ANN ARBOR				
VALVE/MONUMENT BOX ADJUSTMENT				
DR. BY	DF	CH. BY	CSS	DRAWING NO.
SCALE	NONE	DATE	11-6-92	SD-GU-7
INCH	0	1		SHEET NO. _____ OF _____

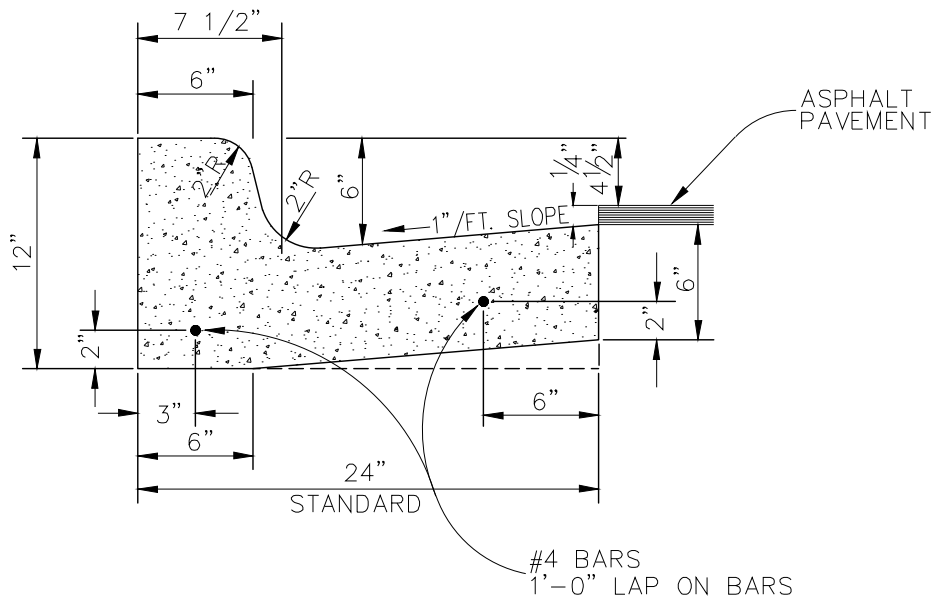

REVISIONS					REV. NO.	DR. BY	CH. BY	DATE
PUBLIC SERVICES DEPARTMENT CITY OF ANN ARBOR								
BARRIER CURB AND GUTTER								
DR. BY	DF	CH. BY	CSS	DRAWING NO.				
SCALE	NONE	DATE	11-6-92	SD-R-1				
INCH	0  1			SHEET NO. ____ OF ____				

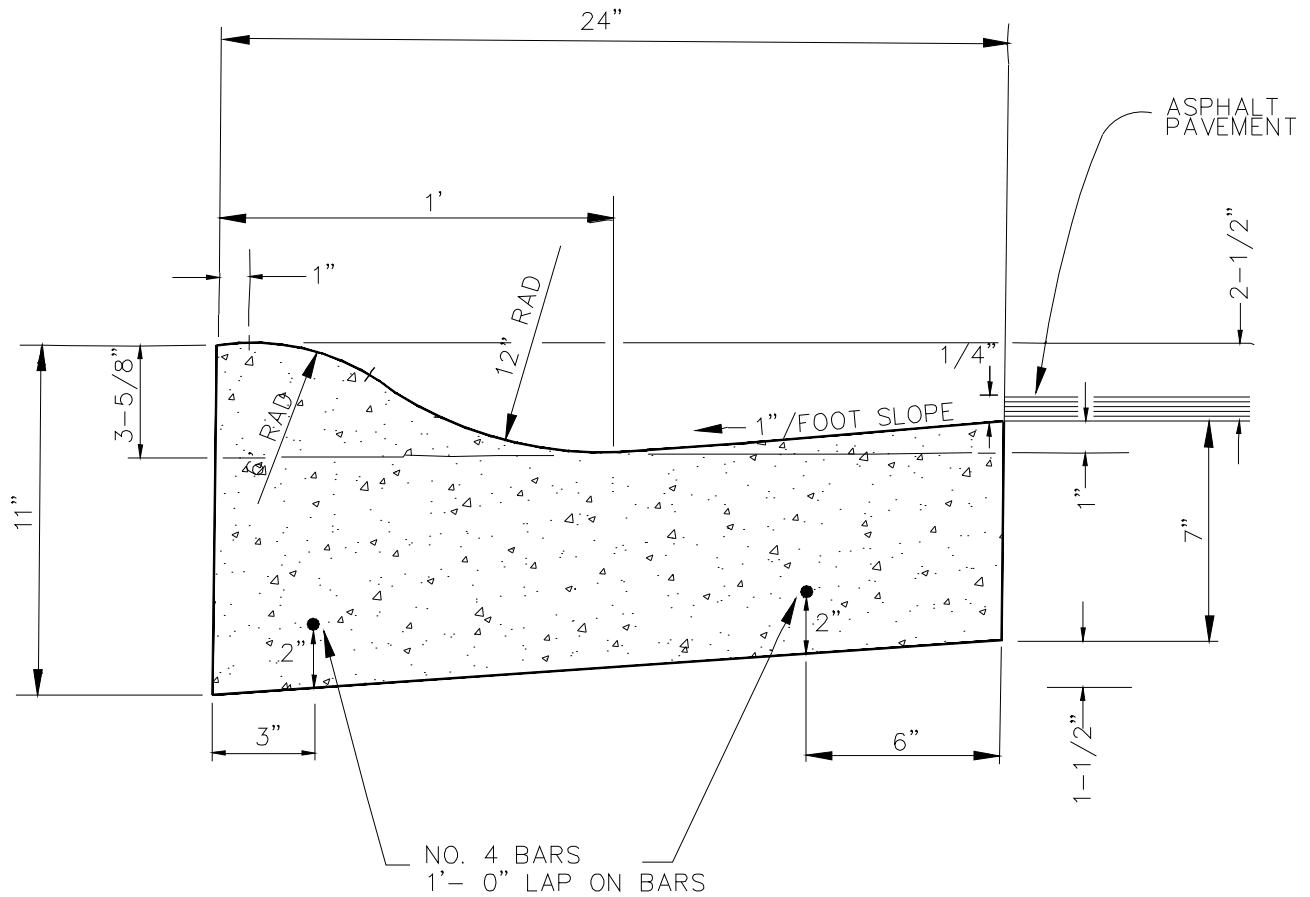

NOTE: FRONT EDGE OF
INLET CASTINGS
SHALL BE FLUSH
WITH FRONT
EDGE OF GUTTER
(EDGE-OF-METAL)

REVISIONS		REV. NO.	DR. BY	CH. BY	DATE
PUBLIC SERVICES DEPARTMENT CITY OF ANN ARBOR					
MOUNTABLE CURB & GUTTER					
DR. BY	DF	CH. BY	CSS	DRAWING NO.	
SCALE	NONE	DATE	11-6-92	SD-R-2	
INCH	0  1			SHEET NO. ____ OF ____	

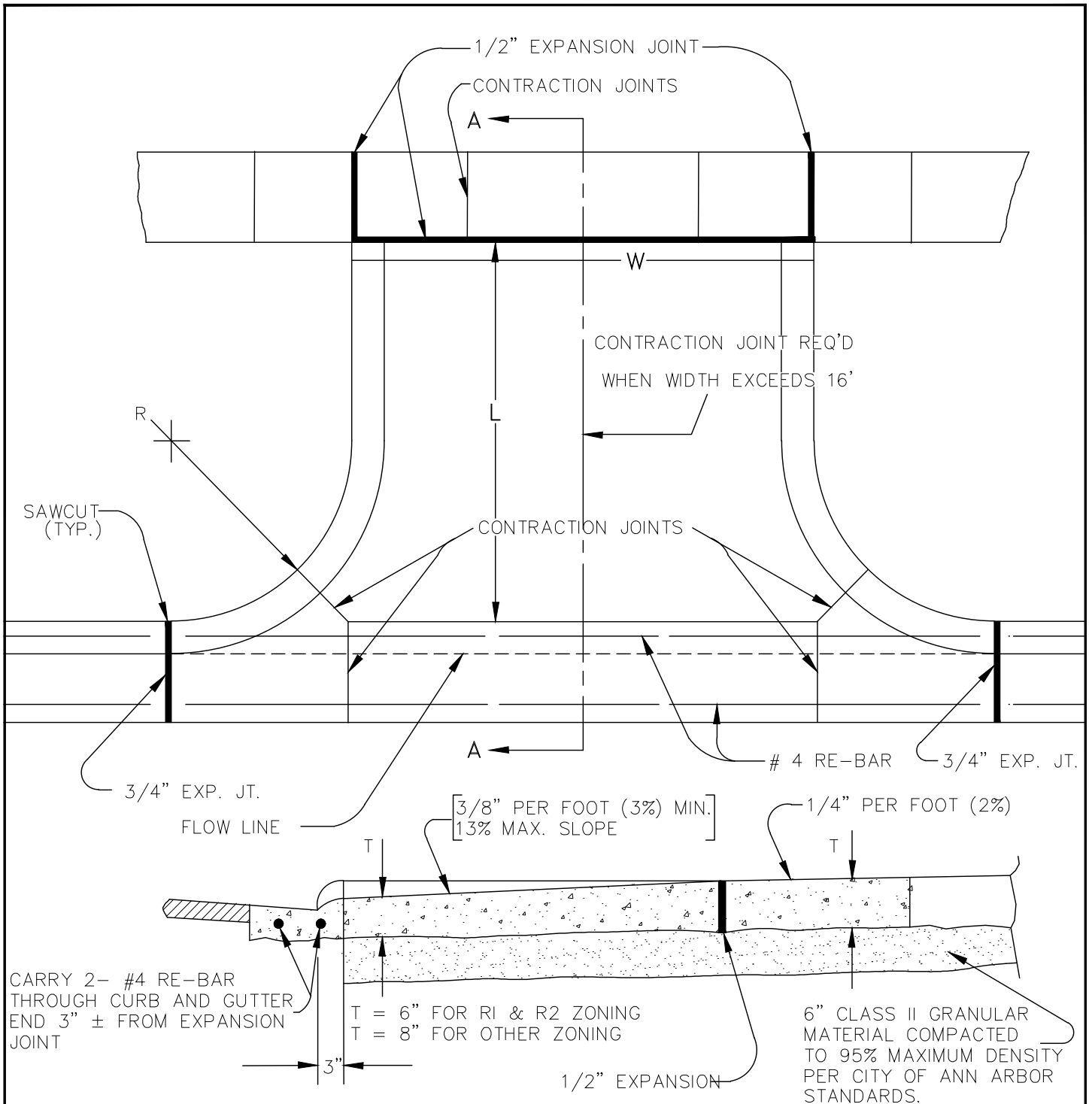

MEASUREMENT OF AREA

$W \times L = \text{AREA}$

NOTE: DRIVE APPROACH TO BE CLASS 'A' CONCRETE

NOTE: R(RADIUS) AND W(DRIVE WIDTH) AS REQUIRED FOR ZONING BY CITY CODE

NOTE: IF GUTTER IS OVERLAYED, GUTTER OF THE APPROACH SHALL BE AT SAME ELEVATION AS EXISTING GUTTER AND ASPHALT WEDGE SHALL BE PLACED IN THE APPROACH.

SEC. A - A

S/W GRADE REVISED		1	NCF	CSS	1-31-94
REVISIONS		REV. NO.	DR. BY	CH. BY	DATE
PUBLIC SERVICES DEPARTMENT CITY OF ANN ARBOR					
TYPE 'M' DRIVE APPROACH (FOR USE ON ASPHALT STREETS WITH BARRIER CURB)					
DR. BY	DF	CH. BY	CSS	DRAWING NO.	
SCALE	NONE	DATE	11-6-92	SD-R-6	
INCH	0 1			SHEET NO. _____ OF _____	

3/8" PER FOOT (3%) MIN.
13% MAX. SLOPE

1/4" PER FOOT (2%)

6" CLASS II GRANULAR
MATERIAL COMPACTED
TO 95% MAXIMUM DENSITY
PER CITY OF ANN ARBOR
STANDARDS.

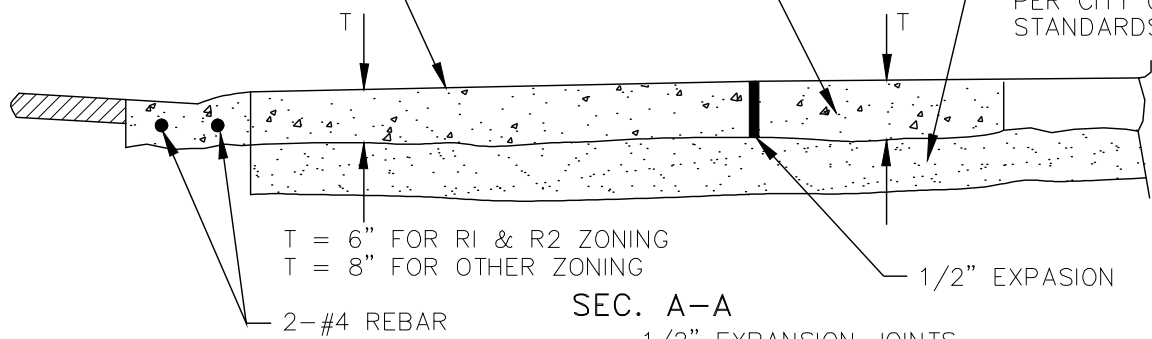

SEC. A-A

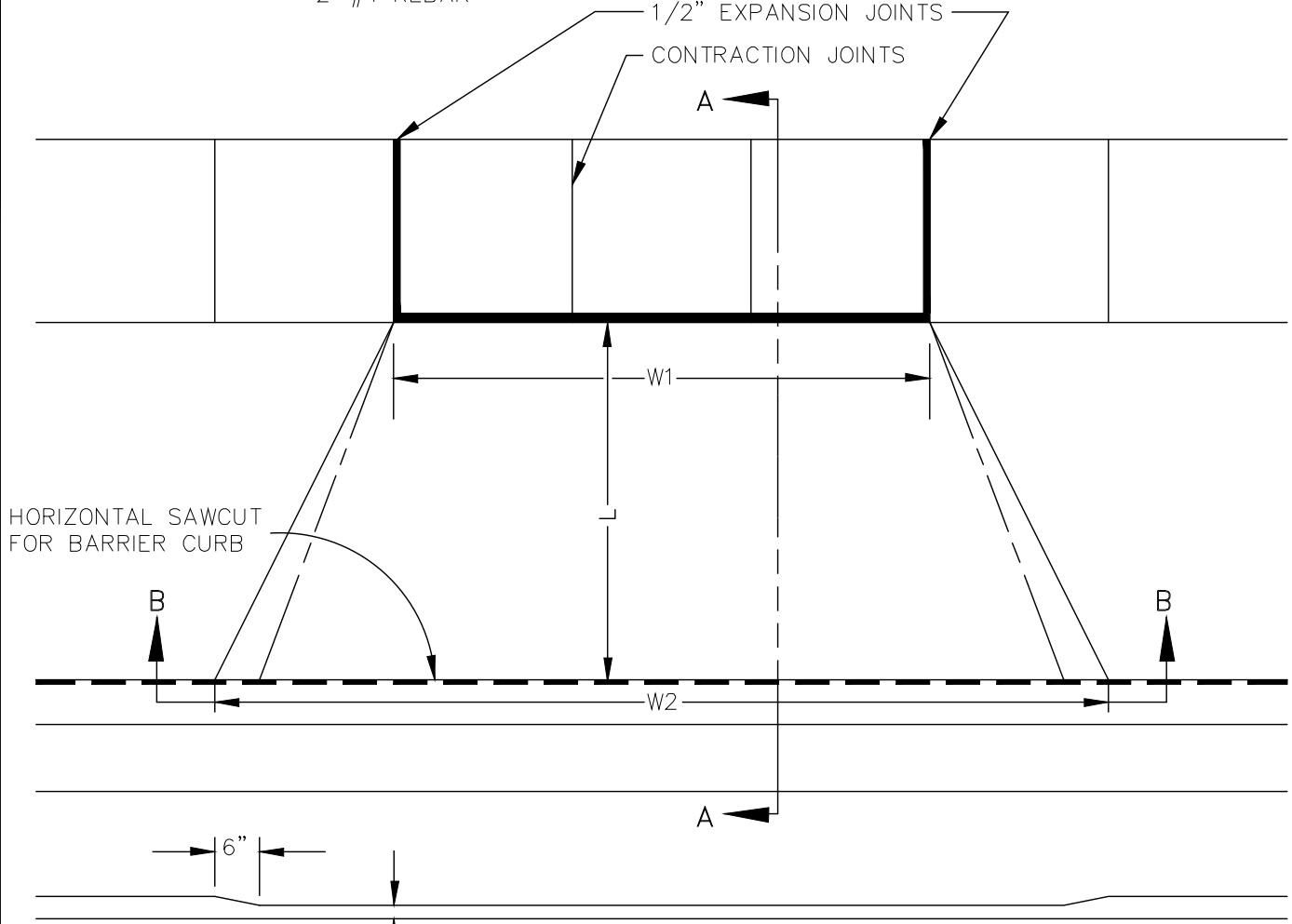

SEC. B-B

NOTE: W1 (DRIVE OPENING WIDTH) AND
W2 (CURB CUT WIDTH)
AS REQUIRED FOR ZONING
BY CITY CODE.

MEASUREMENT OF AREA:
 $1/2 (W1+W2) \times L = \text{AREA}$

NOTE: DRIVE APPROACH TO BE
CLASS 'A' CONCRETE

SEC. B-B; S/W GRADE	1	DPF	CSS	1-31-94
REVISIONS	REV. NO.	DR. BY	CH. BY	DATE
PUBLIC SERVICES DEPARTMENT CITY OF ANN ARBOR				
TYPE 'L' DRIVE APPROACH (FOR USE ON STREETS WITH BARRIER OR MOUNTABLE CURB)				
DR. BY	DF/DCO	CH. BY	CSS/DF	DRAWING NO.
SCALE	NONE	DATE	11-6-92	SD-R-7
INCH	0 1			SHEET NO. ____ OF ____

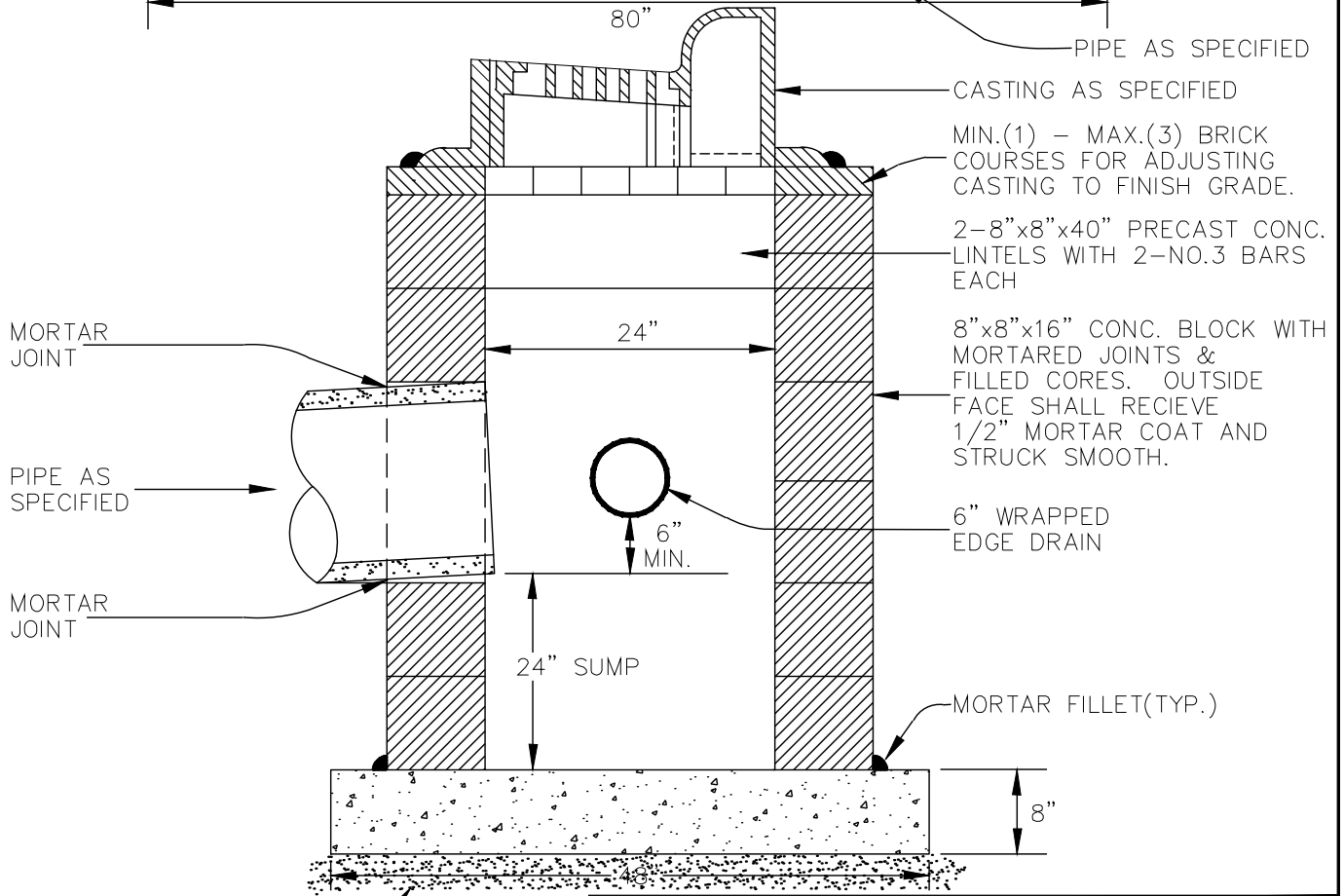
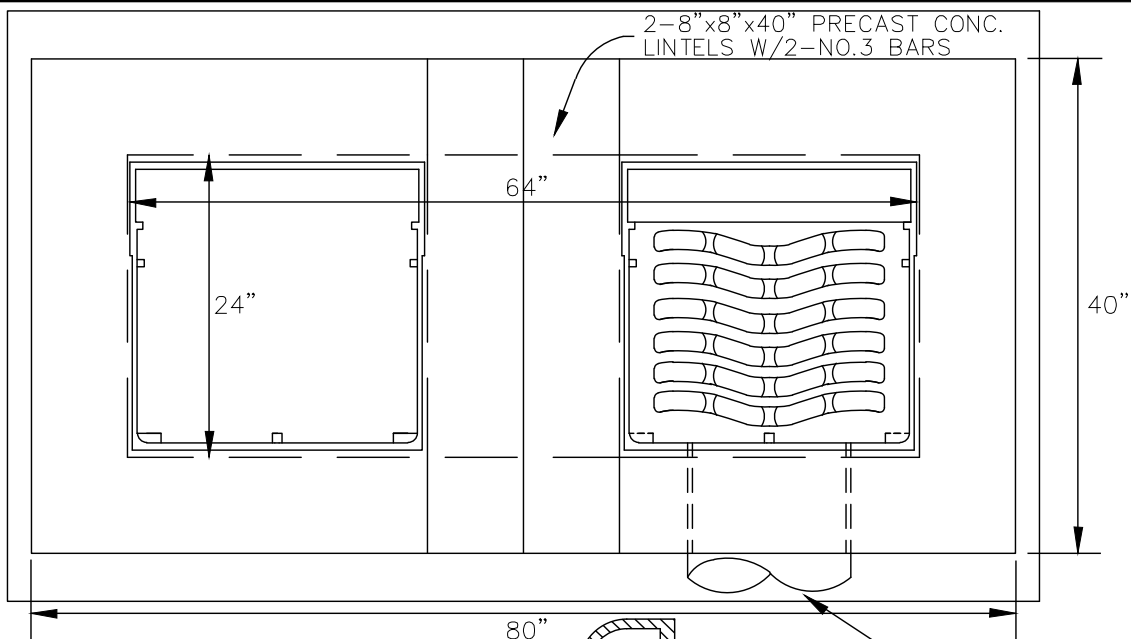

MIN. 4" 21AA STONE BEDDING AND BACKFILL UNDER BASE AND TO FIRST PIPE JOINT.

NOTE: FRONT EDGE OF INLET CASTINGS SHALL BE FLUSH WITH FRONT EDGE OF GUTTER (EDGE-OF-METAL)

CONC. BLOCK REVISED	1	NCF	CSS	1-31-94
REVISIONS	REV. NO.	DR. BY	CH. BY	DATE
PUBLIC SERVICES DEPARTMENT CITY OF ANN ARBOR				
DOUBLE INLET STRUCTURE				
DR. BY	DF/DCO	CH. BY	CSS/DF	DRAWING NO.
SCALE	NONE	DATE	11-6-92	SD-S-11
INCH	0  1			SHEET NO. _____ OF _____

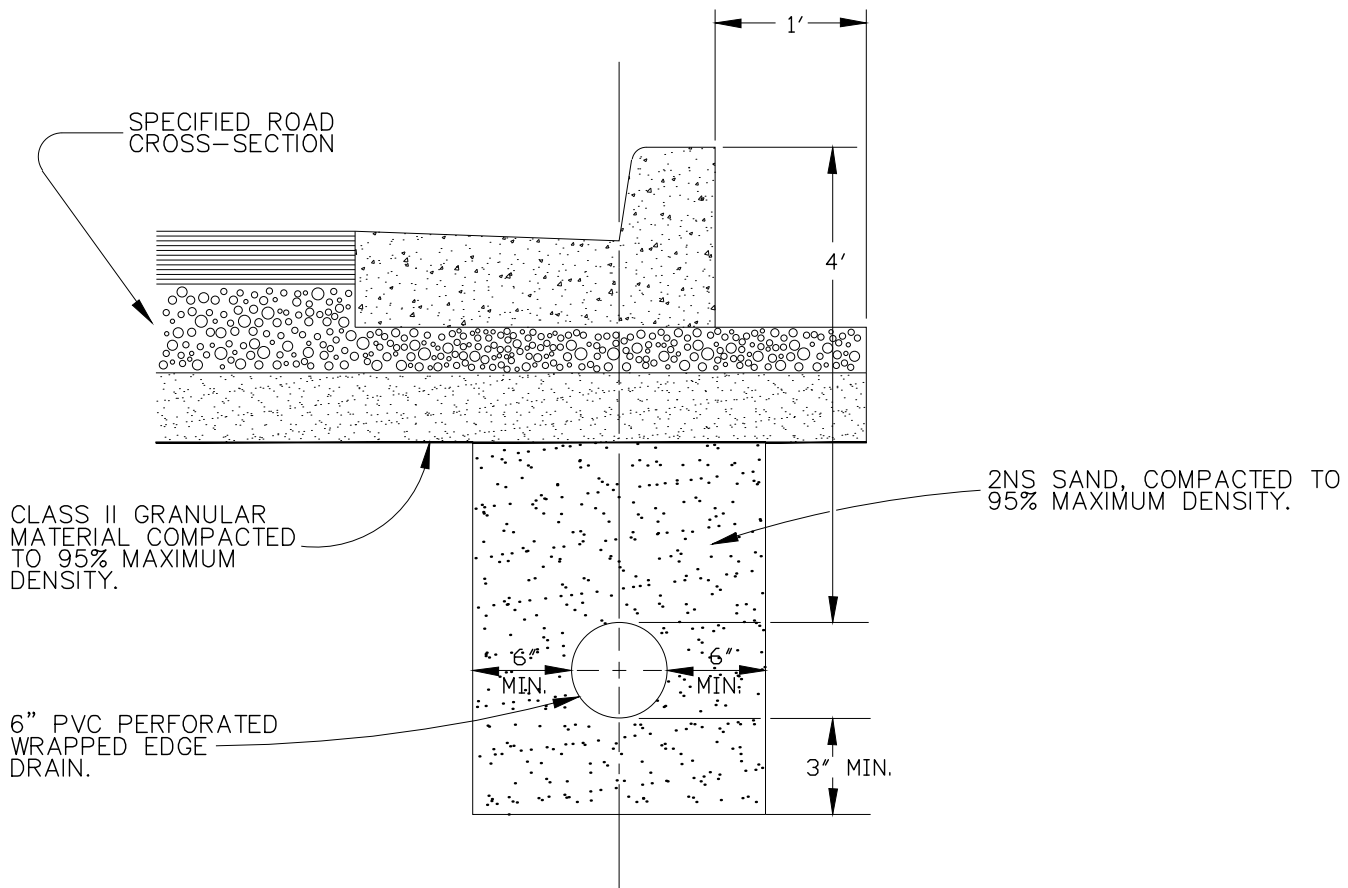

NOTE: FOR PAVEMENT BASE AND SUBBASE THICKNESS, SEE TYPICAL PAVEMENT CROSS-SECTION.

NOTE: DENSITY TESTING PER CITY OF ANN ARBOR SPECIFICATIONS.

NOTE: TRENCH DETAILS SHOW TYPE OF BACKFILL AND SURFACE RESTORATION ONLY.

NOTE: ALL TRENCHING TO CONFORM TO ALL APPLICABLE M.I.O.S.H.A. STANDARDS

REVISIONS		REV. NO.	DR. BY	CH. BY	DATE
PUBLIC SERVICES DEPARTMENT CITY OF ANN ARBOR					
TYPICAL EDGEDRAIN TRENCH					
DR. BY	DF	CH. BY	CSS	DRAWING NO.	
SCALE	NONE	DATE	11-6-92	SD-TD-10	
INCH	0  1			SHEET NO. ____ OF ____	

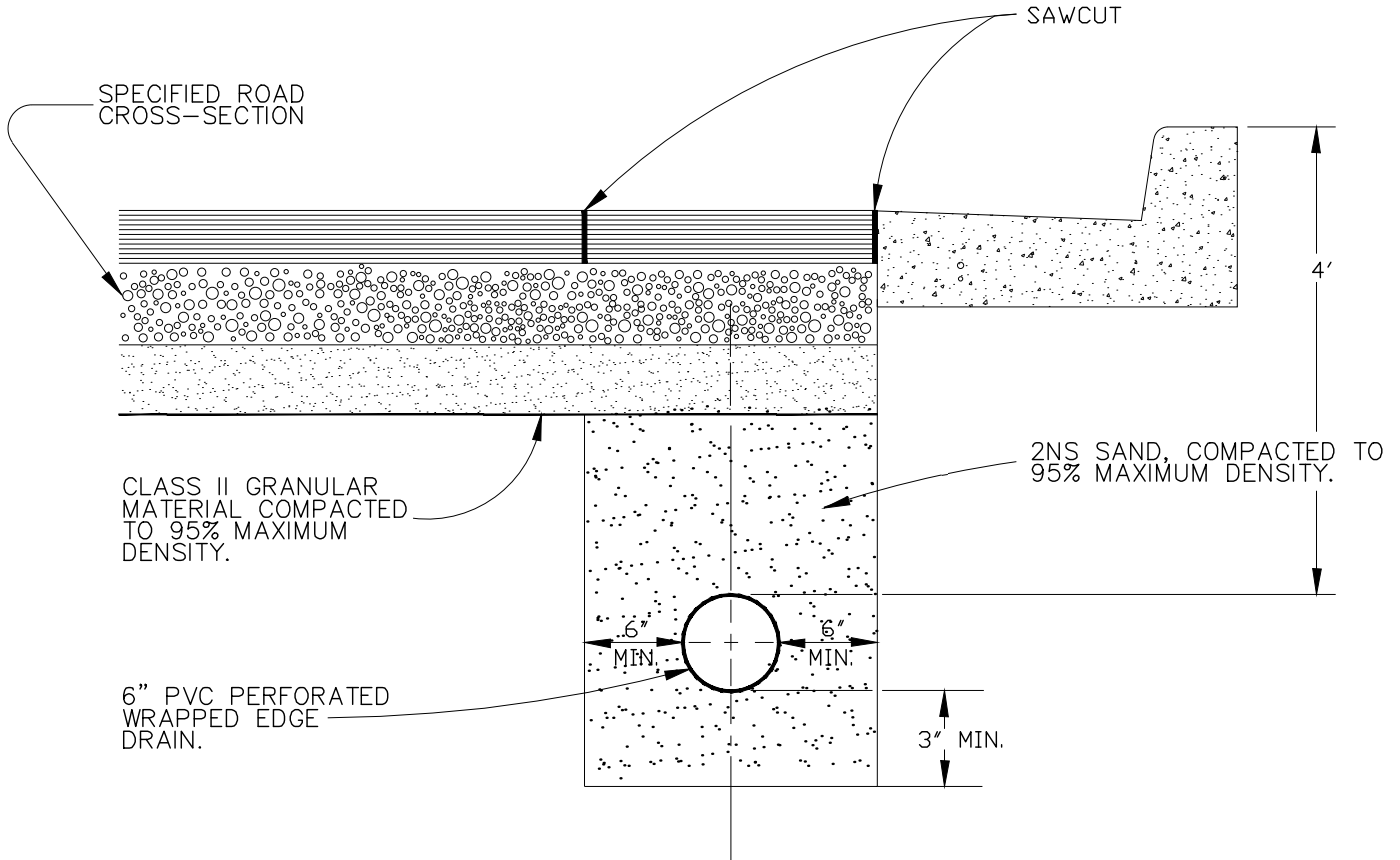

NOTE: FOR PAVEMENT BASE AND SUBBASE THICKNESS, SEE TYPICAL PAVEMENT CROSS-SECTION.

NOTE: DENSITY TESTING PER CITY OF ANN ARBOR SPECIFICATIONS.

NOTE: TRENCH DETAILS SHOW TYPE OF BACKFILL AND SURFACE RESTORATION ONLY.

NOTE: ALL TRENCHING TO CONFORM TO ALL APPLICABLE M.I.O.S.H.A. STANDARDS

REVISIONS				
RETITLED	1	NCF	CSS	1-31-94
DR. BY	DF	CH. BY	CSS	DRAWING NO.
SCALE	NONE	DATE	11-6-92	SD-TD-11
INCH	0  1			SHEET NO. _____ OF _____

Project #: ANNA0039
 Project Name: 2021 Street Resurfacing.

Pavement Core Logs

Date: January 21 through January 25, 2021
 Weather: Partly Cloudy



Crew: Shane Dailey
 Rose Gaglio
 Mike Steep

PC #	Asphalt Thickness (in)	Base Material and thickness (in)	Subbase Material	Nearest Street Address	Measurement from Curb line (Take Photo)	Asphalt Patched	Base Sample Collected
1	3"	3" millings clayey sand w/some gravel	sand	1905 Steere	7' from curb	Yes	Yes
2	4¾"	3" millings gravel w/sand	sand	1946 Steere	7' from curb	Yes	Yes
3	4½"	13" clayey sand w/gravel	clay	1809 Freize Rd	6' from curb	Yes	Yes
4	2½"	8" clayey sand w/gravel	clay	2004 Freize Rd	6' from curb	Yes	Yes
5	4¼"	8" gravel w/sand & clayey	clay	2015 Freize Rd	6' from curb	Yes	Yes
6	3⅞"	sand w/some gravel	sand	1525 Eastover	8' from curb	Yes	Yes
7	3¾"	sand w/gravel	sand	1565 Eastover	7' from curb	Yes	Yes
8	3½"	21AA	sand	1800 Madison	7' from curb	Yes	Yes
9	4"	1" sandy clay w/gravel	clay	1821 Anderson	7' from curb	Yes	Yes
10	4¼"	21AA	sand	2005 Carhart	8' from curb	Yes	Yes
11	4½"	21AA	sand	2024 Carhart	7' from curb	Yes	Yes
12	4¾"	21AA	sand	2112 Carhart	6' from curb	Yes	Yes
13	4¼"	12" clayey sand w/gravel	Clay	1906 Ridge	8' from curb	Yes	Yes
14	3⅞"	10" sand w/gravel	Clay	2005 Ridge	10' from curb	Yes	Yes
15	3 7/8"	clayey sand w/gravel	Clay	2114 Ridge	8' from curb	Yes	Yes
16	3¾"	13" clayey sand w/gravel	Clay	1938 Camelot	8' from curb	Yes	Yes
17	3¼"	clayey sand w/gravel	Clay	2055 Camelot	7' from curb	Yes	Yes
18	5¼"	clayey sand w/gravel	Clay	2420 Gladstone	7' from curb	Yes	Yes
19	4¼"	sandy clay w/gravel	Clay	1946 Ridge	8' from curb	Yes	Yes
20	3⅞"	8" clayey sand w/gravel	sand	2700 Gladstone	10' from curb	Yes	Yes

Project #: ANNA0039

Pavement Core Logs

Date: January 21 through January 25, 2021

Project Name: 2021 Street Resurfacing. Weather: Partly Cloudy



Crew: Shane Dailey, Rose Gaglio, Mike Steep

PC #	Asphalt Thickness (in)	Base Material and thickness (in)	Subbase Material	Nearest Street Address	Measurement from Curb line (Take Photo)	Asphalt Patched	Base Sample Collected
21	3 ¾"	8" clayey sand w/some gravel	sand	2750 Gladstone	8' from curb	Yes	Yes
22	3"	9" sand w/gravel	clay	2810 Gladstone	3.6" N of pave	Yes	Yes
23	3 ½"	9" clayey sand w/gravel	clay	2869 Gladstone	9' from curb	Yes	Yes
24	2 ¾"	7" sand w/gravel	Clay	1809 Independence	11' from curb	Yes	Yes
25	3 ¼"	13" clayey gravel w/sand	Clay	1845 Independence	8' from curb	Yes	Yes
26	3 ¼"	14" gravel w/sand	Clay	1902 Independence	7' from curb	Yes	Yes
27	3"	13" clayey sand w/some gravel	Clay	2005 Independence	9' from curb	Yes	Yes
28	3 ½"	11" clayey sand w/ gravel	Clay	2100 Independence	7' from curb	Yes	Yes
29	3 ½"	11" clayey sand w/ gravel	Clay	2161 Independence	8' from curb	Yes	Yes
32	3 ½"	11" 21AA	clay	2407 Essex	8" from curb	Yes	Yes
33	3"	10" sand w/gravel	clay	2422 Essex	7' from curb	Yes	Yes
34	3 ½"	7" sand w/gravel	obstruction @10"	2644 Towner	8' from curb	Yes	Yes
35	3 ½"	8" clayey sand w/gravel	obstruction @11"	2707 Towner	9' from curb	Yes	Yes
36	3 ¾"	8" clayey sand w/gravel	clay	2808 Towner	9' from curb	Yes	Yes
37	4 ¼"	9" sand w/gravel	obstruction @13"	2711 Canterbury	8' from curb	Yes	Yes
38	4 ¼"	8" sand w/gravel	obstruction @12"	2733 Canterbury	6' from curb	Yes	Yes
39	3 ½"	clayey sand w/gravel	clay	2758 Canterbury	6' from curb	Yes	Yes
40	4 ¼"	silty sand w/gravel	utility trench fill	2821 Canterbury	7' from curb	Yes	Yes

Project #: ANNA0039

Pavement Core Logs

Date: January 21 through January 25, 2021

Weather: Partly Cloudy

Project Name: 2021 Street Resurfacing.



Shane
Crew: Dailey

Rose
Gaglio

Mike
Steep

PC #	Asphalt Thickness (in)	Base Material and thickness (in)	Subbase Material	Nearest Street Address	Measurement from Curb line (Take Photo)	Asphalt Patched	Base Sample Collected
41	5 1/2"	silty sand w/trace of gravel	utility trench fill	2905 Canterbury	6' from curb	Yes	Yes
42	4"	8" clayey sand w/gravel	clay	2906 Chesterfield	8' from curb	Yes	Yes
43	3 1/2"	8" sand w/gravel	clay	2917 Chesterfield	8' from curb	Yes	Yes
44	4"	8" gravel w/sand	clay	2574 Old Boston Ct.	6' from curb	Yes	Yes
45	4 1/2"	8" clayey sand w/gravel	clay	2636 Gloucester Way	6' from curb	Yes	Yes
46	4 1/4"	8" clayey sand w/gravel	clay	2688 Gloucester Way	11" from curb	Yes	Yes
47	4 1/4"	8" gravel w/sand	clay	2752 Gloucester Way	6' from curb	Yes	Yes
48	4 1/2"	silty sand w/gravel	clay	3065 LaSalle	8' from curb	Yes	Yes
49	4 1/4"	clayey sand w/some gravel	clay	3120 LaSalle	7' from curb	Yes	Yes
50	3 1/8"	silty sand w/some gravel	obstruction @ 5"	3190 LaSalle	9' from curb	Yes	Yes
52	1 3/4"	4"-6" silty sand w/some gravel	Sand with Gravel	Bike Path West of King George by the entrance to subdivision		Yes	Yes
53	3 1/2"	4"-6" silty sand w/some gravel	Sand with Gravel	Bike Path Northside west of King George Blvd.		Yes	Yes
54	3 1/2"	4"-6" silty sand w/some gravel	Sand with Gravel	Bike Path Northside between Stone School Road King George Blvd.		Yes	Yes
55	3 1/2"	4"-6" silty sand w/some gravel	Sand with Gravel	Bike Path Northside by intersection with Stone School		Yes	Yes
56	6 3/4"	4"-6" silty sand w/some gravel	Sand with Gravel	Bike Path Northside, just west of entrance to Buhr Park		Yes	Yes
57	3 1/2"	4"-6" silty sand w/some gravel	Sand with Gravel	Bike Path Southside east of Woodmanor Court		Yes	Yes
58	1"	4"-6" silty sand w/some gravel	Sand with Gravel	Bike Path Southside Bet Spring Brook and Norman		Yes	Yes



The Mannik & Smith Group, Inc.
 2365 Haggerty Road South, Canton, MI 48188
 ph: (734) 397-3100 fax: (734) 397-3131
 www.manniksmithgroup.com

CLIENT <u>City of Ann Arbor</u>	PROJECT NAME <u>2021 Street Resurfacing</u>
PROJECT NUMBER <u>ANNA0039</u>	PROJECT LOCATION <u>Ann Arbor, MI</u>
DATE STARTED <u>1/26/21</u> COMPLETED <u>1/26/21</u>	BORING COORDINATES <u>N/A</u>
DRILLING METHOD <u>3.25" Direct Push Casing w/ 2" split spoon</u>	GROUND ELEVATION _____
DRILLING CONTRACTOR <u>MSG</u>	TOTAL DEPTH <u>5.5 FT</u> BACKFILL <u>Bentonite/soil cuttings/ashalt</u>
DRILL RIG <u>Geoprobe 7822DT</u> HAMMER TYPE <u>Automatic</u>	LOGGED BY <u>RG</u> CHECKED BY <u>ISS</u>
DRILLER <u>RJS</u>	REMARKS <u>1810 Baldwin Ave., 8 feet from curb</u>

GRAPHIC LOG	MATERIAL DESCRIPTION	DEPTH (FEET)	SAMPLE TYPE NUMBER	BLOW COUNTS	SPT N VALUE	RECOVERY % (RQD)	DRY DENSITY (PCF)	UNCONF. COMP. STRENGTH (PSF)	MOISTURE CONTENT (%)	▲ SPT N VALUE ▲				ATTERBERG LIMITS			
										10	20	30	40	PL	MC	LL	
	ASPHALT (4 inches)	0.0															
	AGGREGATE BASE (4 inches)																
	Medium dense, brown silty SAND, little gravel, damp (FILL)																
		2.5	SS 1	20-10-6	16	67			7								
			SS 2	4-5-9	14	55											
		5.0	SS 3	9-10-11	21	55											
	Bottom of borehole at 5.5 feet.																

GEOTECH STANDARD LOG - GINT STD US LAB.GDT - 2/15/21 13:29 - C:\USERS\MSCHENK\DESKTOP\ANNA0039.GPJ

LEGEND:

▽ WATER LEVEL AT TIME OF DRILLING N/A D = UCS TEST PERFORMED ON DISTURBED SAMPLE
 ▽ WATER LEVEL AT END OF DRILLING N/A P = POCKET PENETROMETER TEST
 ▽ WATER LEVEL AFTER DRILLING N/A T = TORVANE SHEAR TEST





The Mannik & Smith Group, Inc.
 2365 Haggerty Road South, Canton, MI 48188
 ph: (734) 397-3100 fax: (734) 397-3131
 www.manniksmithgroup.com

CLIENT <u>City of Ann Arbor</u>	PROJECT NAME <u>2021 Street Resurfacing</u>
PROJECT NUMBER <u>ANNA0039</u>	PROJECT LOCATION <u>Ann Arbor, MI</u>
DATE STARTED <u>1/26/21</u> COMPLETED <u>1/26/21</u>	BORING COORDINATES <u>N/A</u>
DRILLING METHOD <u>3.25" Direct Push Casing w/ 2" split spoon</u>	GROUND ELEVATION _____
DRILLING CONTRACTOR <u>MSG</u>	TOTAL DEPTH <u>5.5 FT</u> BACKFILL <u>Bentonite/soil cuttings/ashalt</u>
DRILL RIG <u>Geoprobe 7822DT</u> HAMMER TYPE <u>Automatic</u>	LOGGED BY <u>RG</u> CHECKED BY <u>ISS</u>
DRILLER <u>RJS</u>	REMARKS <u>1800 Baldwin Ave., 6 feet from curb</u>

GRAPHIC LOG	MATERIAL DESCRIPTION	DEPTH (FEET)	SAMPLE TYPE NUMBER	BLOW COUNTS	SPT N VALUE	RECOVERY % (RQD)	DRY DENSITY (PCF)	UNCONF. COMP. STRENGTH (PSF)	MOISTURE CONTENT (%)	▲ SPT N VALUE ▲				ATTERBERG LIMITS		
										10	20	30	40	PL	MC	LL
[Hatched Pattern]	ASPHALT (4 inches)	0.0														
[Cross-hatched Pattern]	AGGREGATE BASE (4 inches)															
[Dotted Pattern]	Medium dense, black gravelly SAND, dry (asphalt-based FILL/millings)															
		2.5	SS 1	15-11-7	18	67			4							
[Dotted Pattern]	Loose, brown silty SAND, trace gravel and clay, damp (SM)															
		5.0	SS 2	6-4-3	7	67										
			SS 3	3-4-4	8	67										
	Bottom of borehole at 5.5 feet.															

GEOTECH STANDARD LOG - GINT STD US LAB.GDT - 2/15/21 13:29 - C:\USERS\MSCHIEK\DESKTOP\ANNA0039.GPJ

LEGEND:

▽ WATER LEVEL AT TIME OF DRILLING <u>N/A</u> ▽ WATER LEVEL AT END OF DRILLING <u>N/A</u> ▽ WATER LEVEL AFTER DRILLING <u>N/A</u>	D = UCS TEST PERFORMED ON DISTURBED SAMPLE P = POCKET PENETROMETER TEST T = TORVANE SHEAR TEST
--	--



The Mannik & Smith Group, Inc.
 2365 Haggerty Road South, Canton, MI 48188
 ph: (734) 397-3100 fax: (734) 397-3131
 www.manniksmithgroup.com

CLIENT <u>City of Ann Arbor</u>	PROJECT NAME <u>2021 Street Resurfacing</u>
PROJECT NUMBER <u>ANNA0039</u>	PROJECT LOCATION <u>Ann Arbor, MI</u>
DATE STARTED <u>1/26/21</u> COMPLETED <u>1/26/21</u>	BORING COORDINATES <u>N/A</u>
DRILLING METHOD <u>3.25" Direct Push Casing w/ 2" split spoon</u>	GROUND ELEVATION _____
DRILLING CONTRACTOR <u>MSG</u>	TOTAL DEPTH <u>5.5 FT</u> BACKFILL <u>Bentonite/soil cuttings/ashalt</u>
DRILL RIG <u>Geoprobe 7822DT</u> HAMMER TYPE <u>Automatic</u>	LOGGED BY <u>RG</u> CHECKED BY <u>ISS</u>
DRILLER <u>RJS</u>	REMARKS <u>3111 Brockman Blvd., 6 feet from curb</u>

GRAPHIC LOG	MATERIAL DESCRIPTION	DEPTH (FEET)	SAMPLE TYPE NUMBER	BLOW COUNTS	SPT N VALUE	RECOVERY % (RQD)	DRY DENSITY (PCF)	UNCONF. COMP. STRENGTH (PSF)	MOISTURE CONTENT (%)	▲ SPT N VALUE ▲				ATTERBERG LIMITS		
										10	20	30	40	PL	MC	LL
										◇ UNCONF. COMP. STRENGTH (PSF) ◇				□ DRY DENSITY (PCF) □		
	ASPHALT (4 inches)	0.0														
	AGGREGATE BASE (4 inches)															
	Medium dense, brown silty SAND, little gravel, damp (FILL)															
		2.5	SS 1	15-14-10	24	67			6							
	Very dense, brown silty SAND, trace gravel and clay, moist (FILL)															
		5.0	SS 2	8-20-30	50	67										
			SS 3	30-25-33	58	67										
	Bottom of borehole at 5.5 feet.															

GEOTECH STANDARD LOG - GINT STD US LAB.GDT - 2/15/21 13:29 - C:\USERS\MSCHIEK\DESKTOP\ANNA0039.GPJ

LEGEND:

▽ WATER LEVEL AT TIME OF DRILLING <u>N/A</u>	D = UCS TEST PERFORMED ON DISTURBED SAMPLE
▽ WATER LEVEL AT END OF DRILLING <u>N/A</u>	P = POCKET PENETROMETER TEST
▽ WATER LEVEL AFTER DRILLING <u>N/A</u>	T = TORVANE SHEAR TEST



The Mannik & Smith Group, Inc.
 2365 Haggerty Road South, Canton, MI 48188
 ph: (734) 397-3100 fax: (734) 397-3131
 www.manniksmithgroup.com

CLIENT <u>City of Ann Arbor</u>	PROJECT NAME <u>2021 Street Resurfacing</u>
PROJECT NUMBER <u>ANNA0039</u>	PROJECT LOCATION <u>Ann Arbor, MI</u>
DATE STARTED <u>1/26/21</u> COMPLETED <u>1/26/21</u>	BORING COORDINATES <u>N/A</u>
DRILLING METHOD <u>3.25" Direct Push Casing w/ 2" split spoon</u>	GROUND ELEVATION _____
DRILLING CONTRACTOR <u>MSG</u>	TOTAL DEPTH <u>5.5 FT</u> BACKFILL <u>Bentonite/soil cuttings/ashalt</u>
DRILL RIG <u>Geoprobe 7822DT</u> HAMMER TYPE <u>Automatic</u>	LOGGED BY <u>RG</u> CHECKED BY <u>ISS</u>
DRILLER <u>RJS</u>	REMARKS <u>3016 Brockman Blvd., 8 feet from curb</u>

GRAPHIC LOG	MATERIAL DESCRIPTION	DEPTH (FEET)	SAMPLE TYPE NUMBER	BLOW COUNTS	SPT N VALUE	RECOVERY % (RQD)	DRY DENSITY (PCF)	UNCONF. COMP. STRENGTH (PSF)	MOISTURE CONTENT (%)	▲ SPT N VALUE ▲				ATTERBERG LIMITS			
										10	20	30	40	PL	MC	LL	
	ASPHALT (4 inches)	0.0															
	AGGREGATE BASE (4 inches)																
	Medium dense, dark brown clayey SAND, little gravel, damp (FILL)																
		2.5	SS 1	8-9-4	13	67			9								
	Medium stiff, dark brown sandy CLAY, trace gravel, damp (FILL)																
			SS 2	4-4-4	8	67		1000 ^P									
	Very soft, brown sandy CLAY, trace gravel, wet (CL)																
		5.0	SS 3	4-4-6	10	67		0 ^P									
	Bottom of borehole at 5.5 feet.																

GEOTECH STANDARD LOG - GINT STD US LAB.GDT - 2/15/21 13:29 - C:\USERS\MSCHIEK\DESKTOP\ANNA0039.GPJ

LEGEND:	
▽ WATER LEVEL AT TIME OF DRILLING <u>N/A</u>	D = UCS TEST PERFORMED ON DISTURBED SAMPLE
▽ WATER LEVEL AT END OF DRILLING <u>N/A</u>	P = POCKET PENETROMETER TEST
▽ WATER LEVEL AFTER DRILLING <u>N/A</u>	T = TORVANE SHEAR TEST





The Mannik & Smith Group, Inc.
 2365 Haggerty Road South, Canton, MI 48188
 ph: (734) 397-3100 fax: (734) 397-3131
 www.manniksmithgroup.com

CLIENT <u>City of Ann Arbor</u>	PROJECT NAME <u>2021 Street Resurfacing</u>
PROJECT NUMBER <u>ANNA0039</u>	PROJECT LOCATION <u>Ann Arbor, MI</u>
DATE STARTED <u>1/26/21</u> COMPLETED <u>1/26/21</u>	BORING COORDINATES <u>N/A</u>
DRILLING METHOD <u>3.25" Direct Push Casing w/ 2" split spoon</u>	GROUND ELEVATION _____
DRILLING CONTRACTOR <u>MSG</u>	TOTAL DEPTH <u>5.5 FT</u> BACKFILL <u>Bentonite/soil cuttings/ashalt</u>
DRILL RIG <u>Geoprobe 7822DT</u> HAMMER TYPE <u>Automatic</u>	LOGGED BY <u>RG</u> CHECKED BY <u>ISS</u>
DRILLER <u>RJS</u>	REMARKS <u>2909 Brockman Blvd., 8 feet from curb</u>

GRAPHIC LOG	MATERIAL DESCRIPTION	DEPTH (FEET)	SAMPLE TYPE NUMBER	BLOW COUNTS	SPT N VALUE	RECOVERY % (RQD)	DRY DENSITY (PCF)	UNCONF. COMP. STRENGTH (PSF)	MOISTURE CONTENT (%)	▲ SPT N VALUE ▲				ATTERBERG LIMITS			
										10	20	30	40	PL	MC	LL	
	ASPHALT (4 inches)	0.0															
	AGGREGATE BASE (5 inches)																
	▽ Stiff, brown silty CLAY, trace sand and gravel, moist to wet (FILL)																
		2.5	SS 1	10-7-5	12	67		2000 ^P	26								
	Stiff, brown silty CLAY, trace sand and gravel, moist (CL)																
			SS 2	3-3-4	7	67		4000 ^P									
		5.0	SS 3	4-6-8	14	67		2500 ^P									
	Bottom of borehole at 5.5 feet.																

LEGEND:

- ▽ WATER LEVEL AT TIME OF DRILLING 1 FEET
- ▽ WATER LEVEL AT END OF DRILLING N/A
- ▽ WATER LEVEL AFTER DRILLING N/A

D = UCS TEST PERFORMED ON DISTURBED SAMPLE

P = POCKET PENETROMETER TEST

T = TORVANE SHEAR TEST



GEOTECH STANDARD LOG - GINT STD US LAB.GDT - 2/15/21 13:29 - C:\USERS\MSCHIEK\DESKTOP\ANNA0039.GPJ



The Mannik & Smith Group, Inc.
 2365 Haggerty Road South, Canton, MI 48188
 ph: (734) 397-3100 fax: (734) 397-3131
 www.manniksmithgroup.com

CLIENT <u>City of Ann Arbor</u>	PROJECT NAME <u>2021 Street Resurfacing</u>
PROJECT NUMBER <u>ANNA0039</u>	PROJECT LOCATION <u>Ann Arbor, MI</u>
DATE STARTED <u>1/26/21</u> COMPLETED <u>1/26/21</u>	BORING COORDINATES <u>N/A</u>
DRILLING METHOD <u>3.25" Direct Push Casing w/ 2" split spoon</u>	GROUND ELEVATION _____
DRILLING CONTRACTOR <u>MSG</u>	TOTAL DEPTH <u>5.5 FT</u> BACKFILL <u>Bentonite/soil cuttings/ashalt</u>
DRILL RIG <u>Geoprobe 7822DT</u> HAMMER TYPE <u>Automatic</u>	LOGGED BY <u>RG</u> CHECKED BY <u>ISS</u>
DRILLER <u>RJS</u>	REMARKS <u>2808 Brockman Blvd., 6 feet from curb</u>

GRAPHIC LOG	MATERIAL DESCRIPTION	DEPTH (FEET)	SAMPLE TYPE NUMBER	BLOW COUNTS	SPT N VALUE	RECOVERY % (RQD)	DRY DENSITY (PCF)	UNCONF. COMP. STRENGTH (PSF)	MOISTURE CONTENT (%)	▲ SPT N VALUE ▲				ATTERBERG LIMITS		
										10	20	30	40	PL	MC	LL
	ASPHALT (3 inches)	0.0														
	AGGREGATE BASE (4 inches)															
	Soft, dark brown sandy CLAY, wet (CL)															
		2.5	SS 1	10-8-4	12	55		660 ^T	22	◆	▲					
	Loose, dark brown clayey SAND, trace gravel, moist (SC)															
			SS 2	3-4-3	7	67										
	Soft, gray sandy CLAY, trace gravel, moist (CL)															
		5.0	SS 3	3-4-5	9	55		1000 ^P		◆	▲					
	Bottom of borehole at 5.5 feet.															

GEOTECH STANDARD LOG - GINT STD US LAB.GDT - 2/15/21 13:29 - C:\USERS\MSCHEIKEN\DESKTOP\ANNA0039.GPJ

LEGEND:	
▽ WATER LEVEL AT TIME OF DRILLING <u>1 FEET</u>	D = UCS TEST PERFORMED ON DISTURBED SAMPLE
▽ WATER LEVEL AT END OF DRILLING <u>N/A</u>	P = POCKET PENETROMETER TEST
▽ WATER LEVEL AFTER DRILLING <u>N/A</u>	T = TORVANE SHEAR TEST





The Mannik & Smith Group, Inc.
 2365 Haggerty Road South, Canton, MI 48188
 ph: (734) 397-3100 fax: (734) 397-3131
 www.manniksmithgroup.com

CLIENT <u>City of Ann Arbor</u>	PROJECT NAME <u>2021 Street Resurfacing</u>
PROJECT NUMBER <u>ANNA0039</u>	PROJECT LOCATION <u>Ann Arbor, MI</u>
DATE STARTED <u>1/26/21</u> COMPLETED <u>1/26/21</u>	BORING COORDINATES <u>N/A</u>
DRILLING METHOD <u>3.25" Direct Push Casing w/ 2" split spoon</u>	GROUND ELEVATION _____
DRILLING CONTRACTOR <u>MSG</u>	TOTAL DEPTH <u>5.5 FT</u> BACKFILL <u>Bentonite/soil cuttings/ashalt</u>
DRILL RIG <u>Geoprobe 7822DT</u> HAMMER TYPE <u>Automatic</u>	LOGGED BY <u>RG</u> CHECKED BY <u>ISS</u>
DRILLER <u>RJS</u>	REMARKS <u>2707 Brockman Blvd., 6 feet from curb</u>

GRAPHIC LOG	MATERIAL DESCRIPTION	DEPTH (FEET)	SAMPLE TYPE NUMBER	BLOW COUNTS	SPT N VALUE	RECOVERY % (RQD)	DRY DENSITY (PCF)	UNCONF. COMP. STRENGTH (PSF)	MOISTURE CONTENT (%)	▲ SPT N VALUE ▲				ATTERBERG LIMITS		
										10	20	30	40	PL	MC	LL
	ASPHALT (3 inches)	0.0														
	AGGREGATE BASE (4 inches)															
	Stiff to very stiff, black/brown/gray silty CLAY, some sand, damp (FILL)															
		2.5	SS 1	10-7-4	11	55		5000 ^P	19							
	Stiff to very stiff, brown silty CLAY, some sand, trace gravel, damp (CL)															
			SS 2	4-5-6	11	67		4500 ^P								
		5.0	SS 3	4-6-9	15	67		1000 ^P								
	Bottom of borehole at 5.5 feet.															

GEOTECH STANDARD LOG - GINT STD US LAB.GDT - 2/15/21 13:29 - C:\USERS\MSCHENK\DESKTOP\ANNA0039.GPJ

LEGEND:

▽ WATER LEVEL AT TIME OF DRILLING N/A D = UCS TEST PERFORMED ON DISTURBED SAMPLE
 ▽ WATER LEVEL AT END OF DRILLING N/A P = POCKET PENETROMETER TEST
 ▽ WATER LEVEL AFTER DRILLING N/A T = TORVANE SHEAR TEST



The Mannik & Smith Group, Inc.
 2365 Haggerty Road South, Canton, MI 48188
 ph: (734) 397-3100 fax: (734) 397-3131
 www.manniksmithgroup.com

CLIENT <u>City of Ann Arbor</u>	PROJECT NAME <u>2021 Street Resurfacing</u>
PROJECT NUMBER <u>ANNA0039</u>	PROJECT LOCATION <u>Ann Arbor, MI</u>
DATE STARTED <u>1/26/21</u> COMPLETED <u>1/26/21</u>	BORING COORDINATES <u>N/A</u>
DRILLING METHOD <u>3.25" Direct Push Casing w/ 2" split spoon</u>	GROUND ELEVATION _____
DRILLING CONTRACTOR <u>MSG</u>	TOTAL DEPTH <u>5.5 FT</u> BACKFILL <u>Bentonite/soil cuttings/ashalt</u>
DRILL RIG <u>Geoprobe 7822DT</u> HAMMER TYPE <u>Automatic</u>	LOGGED BY <u>RG</u> CHECKED BY <u>ISS</u>
DRILLER <u>RJS</u>	REMARKS <u>2600 Brockman Blvd., 5 feet from curb</u>

GRAPHIC LOG	MATERIAL DESCRIPTION	DEPTH (FEET)	SAMPLE TYPE NUMBER	BLOW COUNTS	SPT N VALUE	RECOVERY % (RQD)	DRY DENSITY (PCF)	UNCONF. COMP. STRENGTH (PSF)	MOISTURE CONTENT (%)	▲ SPT N VALUE ▲				ATTERBERG LIMITS			
										10	20	30	40	PL	MC	LL	
	ASPHALT (4 inches)	0.0															
	AGGREGATE BASE (4 inches)																
	Soft, grayish-brown sandy CLAY, little gravel, trace slag fragments, moist (FILL)		SS 1	10-5-4	9	55		500 ^P	15	◇							
	Very stiff to hard, brown silty CLAY, trace sand and gravel, damp (CL)	2.5	SS 2	5-8-8	16	67		6500 ^P									
		5.0	SS 3	11-12-15	27	67		9000+ ^P									
	Bottom of borehole at 5.5 feet.																

GEOTECH STANDARD LOG - GINT STD US LAB.GDT - 2/15/21 13:29 - C:\USERS\MSCHIEK\DESKTOP\ANNA0039.GPJ

LEGEND:
 ▽ WATER LEVEL AT TIME OF DRILLING N/A
 ▽ WATER LEVEL AT END OF DRILLING N/A
 ▽ WATER LEVEL AFTER DRILLING N/A

D = UCS TEST PERFORMED ON DISTURBED SAMPLE
 P = POCKET PENETROMETER TEST
 T = TORVANE SHEAR TEST



The Mannik & Smith Group, Inc.
 2365 Haggerty Road South, Canton, MI 48188
 ph: (734) 397-3100 fax: (734) 397-3131
 www.manniksmithgroup.com

CLIENT <u>City of Ann Arbor</u>	PROJECT NAME <u>2021 Street Resurfacing</u>
PROJECT NUMBER <u>ANNA0039</u>	PROJECT LOCATION <u>Ann Arbor, MI</u>
DATE STARTED <u>1/26/21</u> COMPLETED <u>1/26/21</u>	BORING COORDINATES <u>N/A</u>
DRILLING METHOD <u>3.25" Direct Push Casing w/ 2" split spoon</u>	GROUND ELEVATION _____
DRILLING CONTRACTOR <u>MSG</u>	TOTAL DEPTH <u>5.5 FT</u> BACKFILL <u>Bentonite/soil cuttings/ashalt</u>
DRILL RIG <u>Geoprobe 7822DT</u> HAMMER TYPE <u>Automatic</u>	LOGGED BY <u>RG</u> CHECKED BY <u>ISS</u>
DRILLER <u>RJS</u>	REMARKS <u>2503 Brockman Blvd., 6 feet from curb</u>

GRAPHIC LOG	MATERIAL DESCRIPTION	DEPTH (FEET)	SAMPLE TYPE NUMBER	BLOW COUNTS	SPT N VALUE	RECOVERY % (RQD)	DRY DENSITY (PCF)	UNCONF. COMP. STRENGTH (PSF)	MOISTURE CONTENT (%)	▲ SPT N VALUE ▲				ATTERBERG LIMITS		
										10	20	30	40	PL	MC	LL
	ASPHALT (4 inches)	0.0														
	AGGREGATE BASE (4 inches)															
	Stiff to very stiff, dark brown to gray silty CLAY, some sand, trace gravel, moist (FILL)		SS 1	10-3-10	13	67		5500 ^P	17							
	Very stiff to hard, olive brown and gray mottled silty CLAY, trace sand and gravel, damp (CL)	2.5	SS 2	4-5-8	13	67		8000 ^P								
	@4' brown and gray mottled		SS 3	10-14-15	29	67		9000+ ^P								
	Bottom of borehole at 5.5 feet.	5.0														

GEOTECH STANDARD LOG - GINT STD US LAB.GDT - 2/15/21 13:29 - C:\USERS\MSCHIEK\DESKTOP\ANNA0039.GPJ

LEGEND:

▽ WATER LEVEL AT TIME OF DRILLING N/A D = UCS TEST PERFORMED ON DISTURBED SAMPLE
 ▽ WATER LEVEL AT END OF DRILLING N/A P = POCKET PENETROMETER TEST
 ▽ WATER LEVEL AFTER DRILLING N/A T = TORVANE SHEAR TEST





The Mannik & Smith Group, Inc.
 2365 Haggerty Road South, Canton, MI 48188
 ph: (734) 397-3100 fax: (734) 397-3131
 www.manniksmithgroup.com

CLIENT <u>City of Ann Arbor</u>	PROJECT NAME <u>2021 Street Resurfacing</u>
PROJECT NUMBER <u>ANNA0039</u>	PROJECT LOCATION <u>Ann Arbor, MI</u>
DATE STARTED <u>1/26/21</u> COMPLETED <u>1/26/21</u>	BORING COORDINATES <u>N/A</u>
DRILLING METHOD <u>3.25" Direct Push Casing w/ 2" split spoon</u>	GROUND ELEVATION _____
DRILLING CONTRACTOR <u>MSG</u>	TOTAL DEPTH <u>5.5 FT</u> BACKFILL <u>Bentonite/soil cuttings/ashalt</u>
DRILL RIG <u>Geoprobe 7822DT</u> HAMMER TYPE <u>Automatic</u>	LOGGED BY <u>RG</u> CHECKED BY <u>ISS</u>
DRILLER <u>RJS</u>	REMARKS <u>1901 Ferdon St., 5 feet from curb</u>

GRAPHIC LOG	MATERIAL DESCRIPTION	DEPTH (FEET)	SAMPLE TYPE NUMBER	BLOW COUNTS	SPT N VALUE	RECOVERY % (RQD)	DRY DENSITY (PCF)	UNCONF. COMP. STRENGTH (PSF)	MOISTURE CONTENT (%)	▲ SPT N VALUE ▲				ATTERBERG LIMITS		
										10	20	30	40	PL	MC	LL
	ASPHALT (4 inches)	0.0														
	AGGREGATE BASE (4 inches)															
	Stiff to very stiff, brown sandy CLAY, trace gravel, damp (FILL)															
	@2.5' soft	2.5	SS 1	10-6-5	11	67		4500 ^P	11							
	@4' very stiff		SS 2	5-5-6	11	55		500 ^P								
		5.0	SS 3	8-13-13	26	55		7000 ^P								
	Bottom of borehole at 5.5 feet.															

GEOTECH STANDARD LOG - GINT STD US LAB.GDT - 2/15/21 13:29 - C:\USERS\MSCHIEK\DESKTOP\ANNA0039.GPJ

LEGEND:

▽ WATER LEVEL AT TIME OF DRILLING N/A D = UCS TEST PERFORMED ON DISTURBED SAMPLE
 ▽ WATER LEVEL AT END OF DRILLING N/A P = POCKET PENETROMETER TEST
 ▽ WATER LEVEL AFTER DRILLING N/A T = TORVANE SHEAR TEST





The Mannik & Smith Group, Inc.
 2365 Haggerty Road South, Canton, MI 48188
 ph: (734) 397-3100 fax: (734) 397-3131
 www.manniksmithgroup.com

CLIENT <u>City of Ann Arbor</u>	PROJECT NAME <u>2021 Street Resurfacing</u>
PROJECT NUMBER <u>ANNA0039</u>	PROJECT LOCATION <u>Ann Arbor, MI</u>
DATE STARTED <u>1/27/21</u> COMPLETED <u>1/27/21</u>	BORING COORDINATES <u>N/A</u>
DRILLING METHOD <u>3.25" Direct Push Casing w/ 2" split spoon</u>	GROUND ELEVATION _____
DRILLING CONTRACTOR <u>MSG</u>	TOTAL DEPTH <u>5.5 FT</u> BACKFILL <u>Bentonite/soil cuttings/ashalt</u>
DRILL RIG <u>Geoprobe 7822DT</u> HAMMER TYPE <u>Automatic</u>	LOGGED BY <u>RG</u> CHECKED BY <u>ISS</u>
DRILLER <u>RJS</u>	REMARKS <u>2021 Ferdon St., 6 feet from curb</u>

GRAPHIC LOG	MATERIAL DESCRIPTION	DEPTH (FEET)	SAMPLE TYPE NUMBER	BLOW COUNTS	SPT N VALUE	RECOVERY % (RQD)	DRY DENSITY (PCF)	UNCONF. COMP. STRENGTH (PSF)	MOISTURE CONTENT (%)	▲ SPT N VALUE ▲				ATTERBERG LIMITS		
										10	20	30	40	PL	MC	LL
	ASPHALT (4 inches)	0.0														
	AGGREGATE BASE (4 inches)															
	Very stiff, brown sandy CLAY, trace gravel and ash, damp (FILL)															
	@2.5' medium stiff	2.5	SS 1	15-14-6	20	67			7							
	@4' stiff		SS 2	3-3-5	8	67		1000 ^P								
		5.0	SS 3	5-6-7	13	67										
	Bottom of borehole at 5.5 feet.															

GEOTECH STANDARD LOG - GINT STD US LAB.GDT - 2/15/21 13:29 - C:\USERS\MSCHEIKEN\DESKTOP\ANNA0039.GPJ

LEGEND:

WATER LEVEL AT TIME OF DRILLING N/A
D = UCS TEST PERFORMED ON DISTURBED SAMPLE
 WATER LEVEL AT END OF DRILLING N/A
P = POCKET PENETROMETER TEST
 WATER LEVEL AFTER DRILLING N/A
T = TORVANE SHEAR TEST



The Mannik & Smith Group, Inc.
 2365 Haggerty Road South, Canton, MI 48188
 ph: (734) 397-3100 fax: (734) 397-3131
 www.manniksmithgroup.com

CLIENT <u>City of Ann Arbor</u>	PROJECT NAME <u>2021 Street Resurfacing</u>
PROJECT NUMBER <u>ANNA0039</u>	PROJECT LOCATION <u>Ann Arbor, MI</u>
DATE STARTED <u>1/27/21</u> COMPLETED <u>1/27/21</u>	BORING COORDINATES <u>N/A</u>
DRILLING METHOD <u>3.25" Direct Push Casing w/ 2" split spoon</u>	GROUND ELEVATION _____
DRILLING CONTRACTOR <u>MSG</u>	TOTAL DEPTH <u>5.5 FT</u> BACKFILL <u>Bentonite/soil cuttings/ashalt</u>
DRILL RIG <u>Geoprobe 7822DT</u> HAMMER TYPE <u>Automatic</u>	LOGGED BY <u>RG</u> CHECKED BY <u>ISS</u>
DRILLER <u>RJS</u>	REMARKS <u>2117 Ferdon St., 7 feet from curb</u>

GRAPHIC LOG	MATERIAL DESCRIPTION	DEPTH (FEET)	SAMPLE TYPE NUMBER	BLOW COUNTS	SPT N VALUE	RECOVERY % (RQD)	DRY DENSITY (PCF)	UNCONF. COMP. STRENGTH (PSF)	MOISTURE CONTENT (%)	▲ SPT N VALUE ▲				ATTERBERG LIMITS		
										10	20	30	40	PL	MC	LL
[Hatched Box]	ASPHALT (4 inches)	0.0														
[Hatched Box]	AGGREGATE BASE (4 inches)															
[Hatched Box]	Dense, brown silty SAND, little gravel, damp (FILL)		SS 1	20-25-15	40	55			6							
[Hatched Box]	Medium dense, brown clayey SAND, trace gravel, damp	2.5	SS 2	9-8-7	15	67										
[Hatched Box]		5.0	SS 3	5-5-5	10	67										
	Bottom of borehole at 5.5 feet.															

GEOTECH STANDARD LOG - GINT STD US LAB.GDT - 2/15/21 13:29 - C:\USERS\MSCHIEK\DESKTOP\ANNA0039.GPJ

LEGEND:

▽ WATER LEVEL AT TIME OF DRILLING <u>N/A</u>	D = UCS TEST PERFORMED ON DISTURBED SAMPLE
▽ WATER LEVEL AT END OF DRILLING <u>N/A</u>	P = POCKET PENETROMETER TEST
▽ WATER LEVEL AFTER DRILLING <u>N/A</u>	T = TORVANE SHEAR TEST



The Mannik & Smith Group, Inc.
 2365 Haggerty Road South, Canton, MI 48188
 ph: (734) 397-3100 fax: (734) 397-3131
 www.manniksmithgroup.com

CLIENT <u>City of Ann Arbor</u>	PROJECT NAME <u>2021 Street Resurfacing</u>
PROJECT NUMBER <u>ANNA0039</u>	PROJECT LOCATION <u>Ann Arbor, MI</u>
DATE STARTED <u>1/27/21</u> COMPLETED <u>1/27/21</u>	BORING COORDINATES <u>N/A</u>
DRILLING METHOD <u>3.25" Direct Push Casing w/ 2" split spoon</u>	GROUND ELEVATION _____
DRILLING CONTRACTOR <u>MSG</u>	TOTAL DEPTH <u>5.5 FT</u> BACKFILL <u>Bentonite/soil cuttings/ashalt</u>
DRILL RIG <u>Geoprobe 7822DT</u> HAMMER TYPE <u>Automatic</u>	LOGGED BY <u>RG</u> CHECKED BY <u>ISS</u>
DRILLER <u>RJS</u>	REMARKS <u>Ferdon St., 7 feet from curb</u>

GRAPHIC LOG	MATERIAL DESCRIPTION	DEPTH (FEET)	SAMPLE TYPE NUMBER	BLOW COUNTS	SPT N VALUE	RECOVERY % (RQD)	DRY DENSITY (PCF)	UNCONF. COMP. STRENGTH (PSF)	MOISTURE CONTENT (%)	▲ SPT N VALUE ▲				ATTERBERG LIMITS		
										10	20	30	40	PL	MC	LL
	ASPHALT (3 inches)	0.0														
	AGGREGATE BASE (4 inches)															
	Loose, brown gravelly SAND, little silt and clay, damp (FILL)															
		2.5	SS 1	10-7-3	10	67			5							
	Soft to medium stiff, brown silty CLAY, trace gravel, damp (CL)															
			SS 2	3-2-3	5	67		500 ^P								
	@4' very soft															
		5.0	SS 3	2-2-3	5	67		0 ^P								
	Bottom of borehole at 5.5 feet.															

GEOTECH STANDARD LOG - GINT STD US LAB.GDT - 2/15/21 13:29 - C:\USERS\MSCHEIKEN\DESKTOP\ANNA0039.GPJ

LEGEND:

▽ WATER LEVEL AT TIME OF DRILLING <u>N/A</u>	D = UCS TEST PERFORMED ON DISTURBED SAMPLE
▽ WATER LEVEL AT END OF DRILLING <u>N/A</u>	P = POCKET PENETROMETER TEST
▽ WATER LEVEL AFTER DRILLING <u>N/A</u>	T = TORVANE SHEAR TEST



The Mannik & Smith Group, Inc.
 2365 Haggerty Road South, Canton, MI 48188
 ph: (734) 397-3100 fax: (734) 397-3131
 www.manniksmithgroup.com

CLIENT <u>City of Ann Arbor</u>	PROJECT NAME <u>2021 Street Resurfacing</u>
PROJECT NUMBER <u>ANNA0039</u>	PROJECT LOCATION <u>Ann Arbor, MI</u>
DATE STARTED <u>1/27/21</u> COMPLETED <u>1/27/21</u>	BORING COORDINATES <u>N/A</u>
DRILLING METHOD <u>3.25" Direct Push Casing w/ 2" split spoon</u>	GROUND ELEVATION _____
DRILLING CONTRACTOR <u>MSG</u>	TOTAL DEPTH <u>5.5 FT</u> BACKFILL <u>Bentonite/soil cuttings/ashalt</u>
DRILL RIG <u>Geoprobe 7822DT</u> HAMMER TYPE <u>Automatic</u>	LOGGED BY <u>RG</u> CHECKED BY <u>ISS</u>
DRILLER <u>RJS</u>	REMARKS <u>1555 Crestland Dr. 6 feet from curb</u>

GRAPHIC LOG	MATERIAL DESCRIPTION	DEPTH (FEET)	SAMPLE TYPE NUMBER	BLOW COUNTS	SPT N VALUE	RECOVERY % (RQD)	DRY DENSITY (PCF)	UNCONF. COMP. STRENGTH (PSF)	MOISTURE CONTENT (%)	▲ SPT N VALUE ▲				ATTERBERG LIMITS		
										10	20	30	40	PL	MC	LL
	ASPHALT (3 inches)	0.0														
	AGGREGATE BASE (4 inches)															
	Medium dense, brown and black clayey SAND, trace gravel, damp (asphalt-based FILL/millings)															
		2.5	SS 1	10-9-5	14	55			9							
	Loose, brown silty SAND, trace gravel and clay, damp (SM)															
	@4' medium dense		SS 2	5-3-3	6	55										
		5.0	SS 3	3-7-10	17	67										
	Bottom of borehole at 5.5 feet.															

GEOTECH STANDARD LOG - GINT STD US LAB.GDT - 2/15/21 13:29 - C:\USERS\MSCHIEK\DESKTOP\ANNA0039.GPJ

LEGEND:	
▽ WATER LEVEL AT TIME OF DRILLING <u>N/A</u>	D = UCS TEST PERFORMED ON DISTURBED SAMPLE
▽ WATER LEVEL AT END OF DRILLING <u>N/A</u>	P = POCKET PENETROMETER TEST
▽ WATER LEVEL AFTER DRILLING <u>N/A</u>	T = TORVANE SHEAR TEST





The Mannik & Smith Group, Inc.
 2365 Haggerty Road South, Canton, MI 48188
 ph: (734) 397-3100 fax: (734) 397-3131
 www.manniksmithgroup.com

CLIENT <u>City of Ann Arbor</u>	PROJECT NAME <u>2021 Street Resurfacing</u>
PROJECT NUMBER <u>ANNA0039</u>	PROJECT LOCATION <u>Ann Arbor, MI</u>
DATE STARTED <u>1/27/21</u> COMPLETED <u>1/27/21</u>	BORING COORDINATES <u>N/A</u>
DRILLING METHOD <u>3.25" Direct Push Casing w/ 2" split spoon</u>	GROUND ELEVATION _____
DRILLING CONTRACTOR <u>MSG</u>	TOTAL DEPTH <u>5.5 FT</u> BACKFILL <u>Bentonite/soil cuttings/ashalt</u>
DRILL RIG <u>Geoprobe 7822DT</u> HAMMER TYPE <u>Automatic</u>	LOGGED BY <u>RG</u> CHECKED BY <u>ISS</u>
DRILLER <u>RJS</u>	REMARKS <u>1567 Crestland Dr., 6 feet from curb</u>

GRAPHIC LOG	MATERIAL DESCRIPTION	DEPTH (FEET)	SAMPLE TYPE NUMBER	BLOW COUNTS	SPT N VALUE	RECOVERY % (RQD)	DRY DENSITY (PCF)	UNCONF. COMP. STRENGTH (PSF)	MOISTURE CONTENT (%)	▲ SPT N VALUE ▲				ATTERBERG LIMITS		
										10	20	30	40	PL	MC	LL
0.0	ASPHALT (4 inches)															
0.5	AGGREGATE BASE (4 inches)															
	Loose, brown clayey SAND, trace gravel, damp (FILL)															
2.5	Stiff, dark brown sandy CLAY, trace gravel, organic odor, damp (FILL)		SS 1	10-4-3	7	67			13							
5.0	Medium dense, brown silty SAND, trace gravel and clay, damp (SM)		SS 2	3-4-5	9	67										
	Medium dense, brown silty SAND, trace gravel and clay, damp (SM)		SS 3	5-6-6	12	67										
	Bottom of borehole at 5.5 feet.															

GEOTECH STANDARD LOG - GINT STD US LAB.GDT - 2/15/21 13:29 - C:\USERS\MSCHIEK\DESKTOP\ANNA0039.GPJ

LEGEND:

▽ WATER LEVEL AT TIME OF DRILLING <u>N/A</u>	D = UCS TEST PERFORMED ON DISTURBED SAMPLE
▽ WATER LEVEL AT END OF DRILLING <u>N/A</u>	P = POCKET PENETROMETER TEST
▽ WATER LEVEL AFTER DRILLING <u>N/A</u>	T = TORVANE SHEAR TEST



The Mannik & Smith Group, Inc.
 2365 Haggerty Road South, Canton, MI 48188
 ph: (734) 397-3100 fax: (734) 397-3131
 www.manniksmithgroup.com

CLIENT <u>City of Ann Arbor</u>	PROJECT NAME <u>2021 Street Resurfacing</u>
PROJECT NUMBER <u>ANNA0039</u>	PROJECT LOCATION <u>Ann Arbor, MI</u>
DATE STARTED <u>1/27/21</u> COMPLETED <u>1/27/21</u>	BORING COORDINATES <u>N/A</u>
DRILLING METHOD <u>3.25" Direct Push Casing w/ 2" split spoon</u>	GROUND ELEVATION _____
DRILLING CONTRACTOR <u>MSG</u>	TOTAL DEPTH <u>5.5 FT</u> BACKFILL <u>Bentonite/soil cuttings/ashalt</u>
DRILL RIG <u>Geoprobe 7822DT</u> HAMMER TYPE <u>Automatic</u>	LOGGED BY <u>RG</u> CHECKED BY <u>ISS</u>
DRILLER <u>RJS</u>	REMARKS <u>1810 Crestland Dr., 5 feet from curb</u>

GRAPHIC LOG	MATERIAL DESCRIPTION	DEPTH (FEET)	SAMPLE TYPE NUMBER	BLOW COUNTS	SPT N VALUE	RECOVERY % (RQD)	DRY DENSITY (PCF)	UNCONF. COMP. STRENGTH (PSF)	MOISTURE CONTENT (%)	▲ SPT N VALUE ▲				ATTERBERG LIMITS		
										10	20	30	40	PL	MC	LL
	ASPHALT (4 inches)	0.0														
	AGGREGATE BASE (4 inches)															
	Medium dense, brown silty SAND, trace gravel and clay, damp (FILL)															
		2.5	SS 1	10-10-5	15	67			6							
	Medium stiff to stiff, brown sandy CLAY, trace gravel, damp (CL)															
			SS 2	3-5-7	12	67		1500 ^P								
	Medium stiff, gray silty CLAY, little sand, trace gravel, damp (CL)															
		5.0	SS 3	7-8-8	16	67		1000 ^P								
	Bottom of borehole at 5.5 feet.															

LEGEND:

- ▽ WATER LEVEL AT TIME OF DRILLING N/A
- ▽ WATER LEVEL AT END OF DRILLING N/A
- ▽ WATER LEVEL AFTER DRILLING N/A

D = UCS TEST PERFORMED ON DISTURBED SAMPLE

P = POCKET PENETROMETER TEST

T = TORVANE SHEAR TEST



GEOTECH STANDARD LOG - GINT STD US LAB.GDT - 2/15/21 13:29 - C:\USERS\MSCHIEK\DESKTOP\ANNA0039.GPJ



The Mannik & Smith Group, Inc.
 2365 Haggerty Road South, Canton, MI 48188
 ph: (734) 397-3100 fax: (734) 397-3131
 www.manniksmithgroup.com

CLIENT <u>City of Ann Arbor</u>	PROJECT NAME <u>2021 Street Resurfacing</u>
PROJECT NUMBER <u>ANNA0039</u>	PROJECT LOCATION <u>Ann Arbor, MI</u>
DATE STARTED <u>1/27/21</u> COMPLETED <u>1/27/21</u>	BORING COORDINATES <u>N/A</u>
DRILLING METHOD <u>3.25" Direct Push Casing w/ 2" split spoon</u>	GROUND ELEVATION _____
DRILLING CONTRACTOR <u>MSG</u>	TOTAL DEPTH <u>5.5 FT</u> BACKFILL <u>Bentonite/soil cuttings/ashalt</u>
DRILL RIG <u>Geoprobe 7822DT</u> HAMMER TYPE <u>Automatic</u>	LOGGED BY <u>RG</u> CHECKED BY <u>ISS</u>
DRILLER <u>RJS</u>	REMARKS <u>2001 Crestland Dr., 6 feet from curb</u>

GRAPHIC LOG	MATERIAL DESCRIPTION	DEPTH (FEET)	SAMPLE TYPE NUMBER	BLOW COUNTS	SPT N VALUE	RECOVERY % (RQD)	DRY DENSITY (PCF)	UNCONF. COMP. STRENGTH (PSF)	MOISTURE CONTENT (%)	▲ SPT N VALUE ▲				ATTERBERG LIMITS			
										10	20	30	40	PL	MC	LL	
	ASPHALT (4 inches)	0.0															
	AGGREGATE BASE (4 inches)																
	Stiff to very stiff, dark gray and black sandy CLAY, trace gravel, damp (FILL)																
		2.5	SS 1	13-12-7	19	67		3500 ^P	17								
	Stiff, grayish-brown silty CLAY, little sand, trace gravel, damp (CL)																
			SS 2	7-7-7	14	67		3000 ^P									
	Soft, grayish brown sandy CLAY, trace gravel, damp (CL)																
		5.0	SS 3	5-6-7	13	67		500 ^P									
	Bottom of borehole at 5.5 feet.																

GEOTECH STANDARD LOG - GINT STD US LAB.GDT - 2/15/21 13:29 - C:\USERS\MSCHIEK\DESKTOP\ANNA0039.GPJ

LEGEND:
 ▽ WATER LEVEL AT TIME OF DRILLING N/A
 ▽ WATER LEVEL AT END OF DRILLING N/A
 ▽ WATER LEVEL AFTER DRILLING N/A

D = UCS TEST PERFORMED ON DISTURBED SAMPLE
 P = POCKET PENETROMETER TEST
 T = TORVANE SHEAR TEST



The Mannik & Smith Group, Inc.
 2365 Haggerty Road South, Canton, MI 48188
 ph: (734) 397-3100 fax: (734) 397-3131
 www.manniksmithgroup.com

CLIENT <u>City of Ann Arbor</u>	PROJECT NAME <u>2021 Street Resurfacing</u>
PROJECT NUMBER <u>ANNA0039</u>	PROJECT LOCATION <u>Ann Arbor, MI</u>
DATE STARTED <u>1/27/21</u> COMPLETED <u>1/27/21</u>	BORING COORDINATES <u>N/A</u>
DRILLING METHOD <u>3.25" Direct Push Casing w/ 2" split spoon</u>	GROUND ELEVATION _____
DRILLING CONTRACTOR <u>MSG</u>	TOTAL DEPTH <u>5.5 FT</u> BACKFILL <u>Bentonite/soil cuttings/ashalt</u>
DRILL RIG <u>Geoprobe 7822DT</u> HAMMER TYPE <u>Automatic</u>	LOGGED BY <u>RG</u> CHECKED BY <u>ISS</u>
DRILLER <u>RJS</u>	REMARKS <u>2100 Crestland Dr., 8 feet from curb</u>

GRAPHIC LOG	MATERIAL DESCRIPTION	DEPTH (FEET)	SAMPLE TYPE NUMBER	BLOW COUNTS	SPT N VALUE	RECOVERY % (RQD)	DRY DENSITY (PCF)	UNCONF. COMP. STRENGTH (PSF)	MOISTURE CONTENT (%)	▲ SPT N VALUE ▲				ATTERBERG LIMITS		
										10	20	30	40	PL	MC	LL
[Pattern: Dotted]	ASPHALT (4 inches)	0.0														
[Pattern: Stippled]	AGGREGATE BASE (4 inches)															
[Pattern: Dotted]	Medium dense, brown silty SAND, trace gravel, damp (SM)															
[Pattern: Diagonal Lines]	Stiff to very stiff, brown and gray mottled silty CLAY, trace sand and gravel, damp (CL)	2.5	SS 1	15-9-4	13	55			3							
[Pattern: Diagonal Lines]			SS 2	10-7-7	14	67		6500 ^P								
[Pattern: Diagonal Lines]		5.0	SS 3	8-8-8	16	67		3000 ^P								
	Bottom of borehole at 5.5 feet.															

GEOTECH STANDARD LOG - GINT STD US LAB.GDT - 2/15/21 13:30 - C:\USERS\MSCHIEK\DESKTOP\ANNA0039.GPJ

LEGEND:

▽ WATER LEVEL AT TIME OF DRILLING <u>N/A</u> ▽ WATER LEVEL AT END OF DRILLING <u>N/A</u> ▽ WATER LEVEL AFTER DRILLING <u>N/A</u>	D = UCS TEST PERFORMED ON DISTURBED SAMPLE P = POCKET PENETROMETER TEST T = TORVANE SHEAR TEST
--	--



The Mannik & Smith Group, Inc.
 2365 Haggerty Road South, Canton, MI 48188
 ph: (734) 397-3100 fax: (734) 397-3131
 www.manniksmithgroup.com

CLIENT <u>City of Ann Arbor</u>	PROJECT NAME <u>2021 Street Resurfacing</u>
PROJECT NUMBER <u>ANNA0039</u>	PROJECT LOCATION <u>Ann Arbor, MI</u>
DATE STARTED <u>1/27/21</u> COMPLETED <u>1/27/21</u>	BORING COORDINATES <u>N/A</u>
DRILLING METHOD <u>3.25" Direct Push Casing w/ 2" split spoon</u>	GROUND ELEVATION _____
DRILLING CONTRACTOR <u>MSG</u>	TOTAL DEPTH <u>5.5 FT</u> BACKFILL <u>Bentonite/soil cuttings/ashalt</u>
DRILL RIG <u>Geoprobe 7822DT</u> HAMMER TYPE <u>Automatic</u>	LOGGED BY <u>RG</u> CHECKED BY <u>ISS</u>
DRILLER <u>RJS</u>	REMARKS <u>2115 Crestland, Dr., 5 feet from curb</u>

GRAPHIC LOG	MATERIAL DESCRIPTION	DEPTH (FEET)	SAMPLE TYPE NUMBER	BLOW COUNTS	SPT N VALUE	RECOVERY % (RQD)	DRY DENSITY (PCF)	UNCONF. COMP. STRENGTH (PSF)	MOISTURE CONTENT (%)	▲ SPT N VALUE ▲				ATTERBERG LIMITS		
										10	20	30	40	PL	MC	LL
[Pattern]	ASPHALT (4 inches)	0.0														
[Pattern]	AGGREGATE BASE (4 inches)															
[Pattern]	Medium dense, brown gravelly SAND, damp (FILL)															
[Pattern]	Very stiff, brown silty CLAY, trace sand and gravel, damp (CL)	2.5	SS 1	10-10-6	16	55		7000 ^P	4							
	@2.5' hard															
			SS 2	9-10-10	20	55		9000 ⁺ P								
			SS 3	15-16-17	33	67		9000 ⁺ P								
	Bottom of borehole at 5.5 feet.	5.0														

GEOTECH STANDARD LOG - GINT STD US LAB.GDT - 2/15/21 13:30 - C:\USERS\MSCHIEK\DESKTOP\ANNA0039.GPJ

LEGEND:

▽ WATER LEVEL AT TIME OF DRILLING <u>N/A</u>	D = UCS TEST PERFORMED ON DISTURBED SAMPLE
▽ WATER LEVEL AT END OF DRILLING <u>N/A</u>	P = POCKET PENETROMETER TEST
▽ WATER LEVEL AFTER DRILLING <u>N/A</u>	T = TORVANE SHEAR TEST



The Mannik & Smith Group, Inc.
 2365 Haggerty Road South, Canton, MI 48188
 ph: (734) 397-3100 fax: (734) 397-3131
 www.manniksmithgroup.com

CLIENT <u>City of Ann Arbor</u>	PROJECT NAME <u>2021 Street Resurfacing</u>
PROJECT NUMBER <u>ANNA0039</u>	PROJECT LOCATION <u>Ann Arbor, MI</u>
DATE STARTED <u>2/8/21</u> COMPLETED <u>2/8/21</u>	BORING COORDINATES <u>N/A</u>
DRILLING METHOD <u>3.25" Direct Push Casing w/ 2" split spoon</u>	GROUND ELEVATION _____
DRILLING CONTRACTOR <u>MSG</u>	TOTAL DEPTH <u>5.5 FT</u> BACKFILL <u>Bentonite/soil cuttings/ashalt</u>
DRILL RIG <u>Geoprobe 7822DT</u> HAMMER TYPE <u>Automatic</u>	LOGGED BY <u>RG</u> CHECKED BY <u>ISS</u>
DRILLER <u>RJS</u>	REMARKS <u>2404 Victoria Ave., 6 feet from curb</u>

GRAPHIC LOG	MATERIAL DESCRIPTION	DEPTH (FEET)	SAMPLE TYPE NUMBER	BLOW COUNTS	SPT N VALUE	RECOVERY % (RQD)	DRY DENSITY (PCF)	UNCONF. COMP. STRENGTH (PSF)	MOISTURE CONTENT (%)	▲ SPT N VALUE ▲				ATTERBERG LIMITS			
										10	20	30	40	PL	MC	LL	
	ASPHALT (4 inches)	0.0															
	AGGREGATE BASE (4 inches)																
	Stiff, dark brown sandy CLAY, trace gravel, damp (FILL)																
		2.5	SS 1	14-7-7	14	55			12								
	Very stiff, brown silty CLAY, trace sand and gravel, damp (CL)																
			SS 2	7-9-11	20	67		6500 ^P									
	Very stiff, brown sandy CLAY, trace gravel, damp (CL)																
		5.0	SS 3	12-14-15	29	67		6000 ^P									
	Bottom of borehole at 5.5 feet.																

GEOTECH STANDARD LOG - GINT STD US LAB.GDT - 2/15/21 13:30 - C:\USERS\MSCHIEK\DESKTOP\ANNA0039.GPJ

LEGEND:

WATER LEVEL AT TIME OF DRILLING N/A
D = UCS TEST PERFORMED ON DISTURBED SAMPLE
 WATER LEVEL AT END OF DRILLING N/A
P = POCKET PENETROMETER TEST
 WATER LEVEL AFTER DRILLING N/A
T = TORVANE SHEAR TEST



The Mannik & Smith Group, Inc.
 2365 Haggerty Road South, Canton, MI 48188
 ph: (734) 397-3100 fax: (734) 397-3131
 www.manniksmithgroup.com

CLIENT <u>City of Ann Arbor</u>	PROJECT NAME <u>2021 Street Resurfacing</u>
PROJECT NUMBER <u>ANNA0039</u>	PROJECT LOCATION <u>Ann Arbor, MI</u>
DATE STARTED <u>1/28/21</u> COMPLETED <u>1/28/21</u>	BORING COORDINATES <u>N/A</u>
DRILLING METHOD <u>3.25" Direct Push Casing w/ 2" split spoon</u>	GROUND ELEVATION _____
DRILLING CONTRACTOR <u>MSG</u>	TOTAL DEPTH <u>5.5 FT</u> BACKFILL <u>Bentonite/soil cuttings/ashalt</u>
DRILL RIG <u>Geoprobe 7822DT</u> HAMMER TYPE <u>Automatic</u>	LOGGED BY <u>RG</u> CHECKED BY <u>ISS</u>
DRILLER <u>RJS</u>	REMARKS <u>1902 Independence Blvd., 6 feet from curb</u>

GRAPHIC LOG	MATERIAL DESCRIPTION	DEPTH (FEET)	SAMPLE TYPE NUMBER	BLOW COUNTS	SPT N VALUE	RECOVERY % (RQD)	DRY DENSITY (PCF)	UNCONF. COMP. STRENGTH (PSF)	MOISTURE CONTENT (%)	▲ SPT N VALUE ▲				ATTERBERG LIMITS			
										10	20	30	40	PL	MC	LL	
	ASPHALT (4 inches)	0.0															
	AGGREGATE BASE (4 inches)																
	Medium dense, brown silty SAND, some gravel, dry (FILL)																
		2.5	SS 1	15-10-7	17	67			5								
	Very stiff to hard, dark brown silty CLAY, little sand, trace gravel, damp (FILL)																
			SS 2	7-7-9	16	67		9000 ^P									
	Stiff to very stiff, brown and gray sandy CLAY, trace gravel, damp (likely FILL)																
		5.0	SS 3	7-9-8	17	67		2500 ^P									
	Bottom of borehole at 5.5 feet.																

GEOTECH STANDARD LOG - GINT STD US LAB.GDT - 2/15/21 13:30 - C:\USERS\MSCHIEK\DESKTOP\ANNA0039.GPJ

LEGEND:		
▽ WATER LEVEL AT TIME OF DRILLING <u>N/A</u>	D = UCS TEST PERFORMED ON DISTURBED SAMPLE	
▽ WATER LEVEL AT END OF DRILLING <u>N/A</u>	P = POCKET PENETROMETER TEST	
▽ WATER LEVEL AFTER DRILLING <u>N/A</u>	T = TORVANE SHEAR TEST	





The Mannik & Smith Group, Inc.
 2365 Haggerty Road South, Canton, MI 48188
 ph: (734) 397-3100 fax: (734) 397-3131
 www.manniksmithgroup.com

CLIENT <u>City of Ann Arbor</u>	PROJECT NAME <u>2021 Street Resurfacing</u>
PROJECT NUMBER <u>ANNA0039</u>	PROJECT LOCATION <u>Ann Arbor, MI</u>
DATE STARTED <u>1/28/21</u> COMPLETED <u>1/28/21</u>	BORING COORDINATES <u>N/A</u>
DRILLING METHOD <u>3.25" Direct Push Casing w/ 2" split spoon</u>	GROUND ELEVATION _____
DRILLING CONTRACTOR <u>MSG</u>	TOTAL DEPTH <u>5.5 FT</u> BACKFILL <u>Bentonite/soil cuttings/ashalt</u>
DRILL RIG <u>Geoprobe 7822DT</u> HAMMER TYPE <u>Automatic</u>	LOGGED BY <u>RG</u> CHECKED BY <u>ISS</u>
DRILLER <u>RJS</u>	REMARKS <u>1900 Manchester Rd., 6 feet from curb</u>

GRAPHIC LOG	MATERIAL DESCRIPTION	DEPTH (FEET)	SAMPLE TYPE NUMBER	BLOW COUNTS	SPT N VALUE	RECOVERY % (RQD)	DRY DENSITY (PCF)	UNCONF. COMP. STRENGTH (PSF)	MOISTURE CONTENT (%)	▲ SPT N VALUE ▲				ATTERBERG LIMITS		
										10	20	30	40	PL	MC	LL
	ASPHALT (4 inches)	0.0														
	AGGREGATE BASE (4 inches)															
	Medium dense, gray gravelly SAND, some silt, little clay, damp (FILL)															
		2.5	SS 1	10-8-10	18	55			6							
	Medium dense, brown clayey SAND, trace gravel, damp (SC)															
			SS 2	10-10-8	18	67										
	Medium dense, brown silty SAND, trace gravel and clay, damp (SM)															
		5.0	SS 3	8-9-10	19	67										
	Bottom of borehole at 5.5 feet.															

GEOTECH STANDARD LOG - GINT STD US LAB.GDT - 2/15/21 13:30 - C:\USERS\MSCHIEK\DESKTOP\ANNA0039.GPJ

LEGEND:	
▽ WATER LEVEL AT TIME OF DRILLING <u>N/A</u>	D = UCS TEST PERFORMED ON DISTURBED SAMPLE
▽ WATER LEVEL AT END OF DRILLING <u>N/A</u>	P = POCKET PENETROMETER TEST
▽ WATER LEVEL AFTER DRILLING <u>N/A</u>	T = TORVANE SHEAR TEST





The Mannik & Smith Group, Inc.
 2365 Haggerty Road South, Canton, MI 48188
 ph: (734) 397-3100 fax: (734) 397-3131
 www.manniksmithgroup.com

CLIENT <u>City of Ann Arbor</u>	PROJECT NAME <u>2021 Street Resurfacing</u>
PROJECT NUMBER <u>ANNA0039</u>	PROJECT LOCATION <u>Ann Arbor, MI</u>
DATE STARTED <u>1/28/21</u> COMPLETED <u>1/28/21</u>	BORING COORDINATES <u>N/A</u>
DRILLING METHOD <u>3.25" Direct Push Casing w/ 2" split spoon</u>	GROUND ELEVATION _____
DRILLING CONTRACTOR <u>MSG</u>	TOTAL DEPTH <u>5.5 FT</u> BACKFILL <u>Bentonite/soil cuttings/ashalt</u>
DRILL RIG <u>Geoprobe 7822DT</u> HAMMER TYPE <u>Automatic</u>	LOGGED BY <u>RG</u> CHECKED BY <u>ISS</u>
DRILLER <u>RJS</u>	REMARKS <u>1950 Manchester Rd., 12 feet from curb</u>

GRAPHIC LOG	MATERIAL DESCRIPTION	DEPTH (FEET)	SAMPLE TYPE NUMBER	BLOW COUNTS	SPT N VALUE	RECOVERY % (RQD)	DRY DENSITY (PCF)	UNCONF. COMP. STRENGTH (PSF)	MOISTURE CONTENT (%)	▲ SPT N VALUE ▲				ATTERBERG LIMITS		
										10	20	30	40	PL	MC	LL
[Hatched Box]	ASPHALT (4 inches)	0.0														
[Hatched Box]	AGGREGATE BASE (4 inches)															
[Dotted Box]	Medium dense, gray gravelly SAND (crushed asphalt/millings), little silt and clay, damp (FILL)		SS 1	10-10-10	20	67			4							
[Dotted Box]	Medium dense, brown clayey SAND, some gravel, damp (FILL)	2.5	SS 2	8-9-9	18	67										
[Dotted Box]	Medium dense, brown silty SAND, little clay, trace gravel, damp (SM)	5.0	SS 3	9-9-11	20	67										
	Bottom of borehole at 5.5 feet.															

GEOTECH STANDARD LOG - GINT STD US LAB.GDT - 2/15/21 13:30 - C:\USERS\MSCHEIKEN\DESKTOP\ANNA0039.GPJ

LEGEND:

▽ WATER LEVEL AT TIME OF DRILLING <u>N/A</u> ▽ WATER LEVEL AT END OF DRILLING <u>N/A</u> ▽ WATER LEVEL AFTER DRILLING <u>N/A</u>	D = UCS TEST PERFORMED ON DISTURBED SAMPLE P = POCKET PENETROMETER TEST T = TORVANE SHEAR TEST
--	--



The Mannik & Smith Group, Inc.
 2365 Haggerty Road South, Canton, MI 48188
 ph: (734) 397-3100 fax: (734) 397-3131
 www.manniksmithgroup.com

CLIENT <u>City of Ann Arbor</u>	PROJECT NAME <u>2021 Street Resurfacing</u>
PROJECT NUMBER <u>ANNA0039</u>	PROJECT LOCATION <u>Ann Arbor, MI</u>
DATE STARTED <u>1/28/21</u> COMPLETED <u>1/28/21</u>	BORING COORDINATES <u>N/A</u>
DRILLING METHOD <u>3.25" Direct Push Casing w/ 2" split spoon</u>	GROUND ELEVATION _____
DRILLING CONTRACTOR <u>MSG</u>	TOTAL DEPTH <u>5.5 FT</u> BACKFILL <u>Bentonite/soil cuttings/ashalt</u>
DRILL RIG <u>Geoprobe 7822DT</u> HAMMER TYPE <u>Automatic</u>	LOGGED BY <u>RG</u> CHECKED BY <u>ISS</u>
DRILLER <u>RJS</u>	REMARKS <u>2012 Manchester Rd., 6 feet from curb</u>

GRAPHIC LOG	MATERIAL DESCRIPTION	DEPTH (FEET)	SAMPLE TYPE NUMBER	BLOW COUNTS	SPT N VALUE	RECOVERY % (RQD)	DRY DENSITY (PCF)	UNCONF. COMP. STRENGTH (PSF)	MOISTURE CONTENT (%)	▲ SPT N VALUE ▲				ATTERBERG LIMITS		
										10	20	30	40	PL	MC	LL
										◇ UNCONF. COMP. STRENGTH (PSF) ◇				□ DRY DENSITY (PCF) □		
	ASPHALT (4 inches)	0.0														
	AGGREGATE BASE (4 inches)															
	Medium dense, black gravelly SAND (crushed asphalt/millings), dry (FILL)															
		2.5	SS 1	9-10-13	23	67			3							
	Medium dense, brown gravelly SAND, some silt, little clay, damp (FILL)															
			SS 2	9-8-8	16	67										
	Medium dense, brown silty SAND, trace gravel and clay, damp (SM)															
		5.0	SS 3	7-6-5	11	67										
	Bottom of borehole at 5.5 feet.															

GEOTECH STANDARD LOG - GINT STD US LAB.GDT - 2/15/21 13:30 - C:\USERS\MSCHIEK\DESKTOP\ANNA0039.GPJ

LEGEND:

▽ WATER LEVEL AT TIME OF DRILLING <u>N/A</u>	D = UCS TEST PERFORMED ON DISTURBED SAMPLE
▽ WATER LEVEL AT END OF DRILLING <u>N/A</u>	P = POCKET PENETROMETER TEST
▽ WATER LEVEL AFTER DRILLING <u>N/A</u>	T = TORVANE SHEAR TEST



The Mannik & Smith Group, Inc.
 2365 Haggerty Road South, Canton, MI 48188
 ph: (734) 397-3100 fax: (734) 397-3131
 www.manniksmithgroup.com

CLIENT <u>City of Ann Arbor</u>	PROJECT NAME <u>2021 Street Resurfacing</u>
PROJECT NUMBER <u>ANNA0039</u>	PROJECT LOCATION <u>Ann Arbor, MI</u>
DATE STARTED <u>1/28/21</u> COMPLETED <u>1/28/21</u>	BORING COORDINATES <u>N/A</u>
DRILLING METHOD <u>3.25" Direct Push Casing w/ 2" split spoon</u>	GROUND ELEVATION _____
DRILLING CONTRACTOR <u>MSG</u>	TOTAL DEPTH <u>5.5 FT</u> BACKFILL <u>Bentonite/soil cuttings/ashalt</u>
DRILL RIG <u>Geoprobe 7822DT</u> HAMMER TYPE <u>Automatic</u>	LOGGED BY <u>RG</u> CHECKED BY <u>ISS</u>
DRILLER <u>RJS</u>	REMARKS <u>2180 Medford Rd., 5 feet from curb</u>

GRAPHIC LOG	MATERIAL DESCRIPTION	DEPTH (FEET)	SAMPLE TYPE NUMBER	BLOW COUNTS	SPT N VALUE	RECOVERY % (RQD)	DRY DENSITY (PCF)	UNCONF. COMP. STRENGTH (PSF)	MOISTURE CONTENT (%)	▲ SPT N VALUE ▲				ATTERBERG LIMITS		
										10	20	30	40	PL	MC	LL
	ASPHALT (4 inches)	0.0														
	AGGREGATE BASE (4 inches)															
	Medium dense, black gravelly SAND (asphalt-based FILL/millings), dry															
		2.5	SS 1	8-10-10	20	55			2							
	Hard, brown and gray mottled silty CLAY, trace sand and gravel, damp (CL)															
	@4' brown		SS 2	10-8-9	17	55		9000 ^P								
		5.0	SS 3	7-7-7	14	67		9000 ^P								
	Bottom of borehole at 5.5 feet.															

GEOTECH STANDARD LOG - GINT STD US LAB.GDT - 2/15/21 13:30 - C:\USERS\MSCHIEK\DESKTOP\ANNA0039.GPJ

LEGEND:		
▽ WATER LEVEL AT TIME OF DRILLING <u>N/A</u>	D = UCS TEST PERFORMED ON DISTURBED SAMPLE	
▽ WATER LEVEL AT END OF DRILLING <u>N/A</u>	P = POCKET PENETROMETER TEST	
▽ WATER LEVEL AFTER DRILLING <u>N/A</u>	T = TORVANE SHEAR TEST	





The Mannik & Smith Group, Inc.
 2365 Haggerty Road South, Canton, MI 48188
 ph: (734) 397-3100 fax: (734) 397-3131
 www.manniksmithgroup.com

CLIENT <u>City of Ann Arbor</u>	PROJECT NAME <u>2021 Street Resurfacing</u>
PROJECT NUMBER <u>ANNA0039</u>	PROJECT LOCATION <u>Ann Arbor, MI</u>
DATE STARTED <u>1/28/21</u> COMPLETED <u>1/28/21</u>	BORING COORDINATES <u>N/A</u>
DRILLING METHOD <u>3.25" Direct Push Casing w/ 2" split spoon</u>	GROUND ELEVATION _____
DRILLING CONTRACTOR <u>MSG</u>	TOTAL DEPTH <u>5.5 FT</u> BACKFILL <u>Bentonite/soil cuttings/ashalt</u>
DRILL RIG <u>Geoprobe 7822DT</u> HAMMER TYPE <u>Automatic</u>	LOGGED BY <u>RG</u> CHECKED BY <u>ISS</u>
DRILLER <u>RJS</u>	REMARKS <u>2218 Manchester Rd., 5 feet from curb</u>

GRAPHIC LOG	MATERIAL DESCRIPTION	DEPTH (FEET)	SAMPLE TYPE NUMBER	BLOW COUNTS	SPT N VALUE	RECOVERY % (RQD)	DRY DENSITY (PCF)	UNCONF. COMP. STRENGTH (PSF)	MOISTURE CONTENT (%)	▲ SPT N VALUE ▲				ATTERBERG LIMITS		
										10	20	30	40	PL	MC	LL
	ASPHALT (3 inches)	0.0														
	AGGREGATE BASE (4 inches)															
	Loose, gray gravelly SAND, some silt, little clay, damp (crushed limestone FILL)		SS 1	8-4-5	9	67			6							
	Very stiff to hard, trace silty CLAY, trace sand and gravel, damp (CL)	2.5	SS 2	5-9-10	19	67		9000+ ^P								
		5.0	SS 3	9-10-15	25	67		9000+ ^P								
	Bottom of borehole at 5.5 feet.															

GEOTECH STANDARD LOG - GINT STD US LAB.GDT - 2/15/21 13:30 - C:\USERS\MSCHEIKEN\DESKTOP\ANNA0039.GPJ

LEGEND:

▽ WATER LEVEL AT TIME OF DRILLING N/A D = UCS TEST PERFORMED ON DISTURBED SAMPLE

▽ WATER LEVEL AT END OF DRILLING N/A P = POCKET PENETROMETER TEST

▽ WATER LEVEL AFTER DRILLING N/A T = TORVANE SHEAR TEST





The Mannik & Smith Group, Inc.
 2365 Haggerty Road South, Canton, MI 48188
 ph: (734) 397-3100 fax: (734) 397-3131
 www.manniksmithgroup.com

CLIENT <u>City of Ann Arbor</u>	PROJECT NAME <u>2021 Street Resurfacing</u>
PROJECT NUMBER <u>ANNA0039</u>	PROJECT LOCATION <u>Ann Arbor, MI</u>
DATE STARTED <u>1/28/21</u> COMPLETED <u>1/28/21</u>	BORING COORDINATES <u>N/A</u>
DRILLING METHOD <u>3.25" Direct Push Casing w/ 2" split spoon</u>	GROUND ELEVATION _____
DRILLING CONTRACTOR <u>MSG</u>	TOTAL DEPTH <u>5.5 FT</u> BACKFILL <u>Bentonite/soil cuttings/ashalt</u>
DRILL RIG <u>Geoprobe 7822DT</u> HAMMER TYPE <u>Automatic</u>	LOGGED BY <u>RG</u> CHECKED BY <u>ISS</u>
DRILLER <u>RJS</u>	REMARKS <u>2281 Manchester Rd., 5 feet from curb</u>

GRAPHIC LOG	MATERIAL DESCRIPTION	DEPTH (FEET)	SAMPLE TYPE NUMBER	BLOW COUNTS	SPT N VALUE	RECOVERY % (RQD)	DRY DENSITY (PCF)	UNCONF. COMP. STRENGTH (PSF)	MOISTURE CONTENT (%)	▲ SPT N VALUE ▲				ATTERBERG LIMITS		
										10	20	30	40	PL	MC	LL
0.0	ASPHALT (3 inches) AGGREGATE BASE									◇ UNCONF. COMP. STRENGTH (PSF) ◇				□ DRY DENSITY (PCF) □		
2.5	Hard, brownish-gray silty CLAY, trace sand and gravel, damp (CL) @4' very stiff		SS 1	10-10-8	18	55			7	2000 4000 6000 8000				100 110 120 130		
5.0			SS 2	6-6-7	13	55		8500 ^P								
5.0			SS 3	8-8-8	16	67		6000 ^P								
	Bottom of borehole at 5.5 feet.															

GEOTECH STANDARD LOG - GINT STD US LAB.GDT - 2/15/21 13:30 - C:\USERS\MSCHIEK\DESKTOP\ANNA0039.GPJ

LEGEND:

▽ WATER LEVEL AT TIME OF DRILLING <u>N/A</u>	D = UCS TEST PERFORMED ON DISTURBED SAMPLE
▽ WATER LEVEL AT END OF DRILLING <u>N/A</u>	P = POCKET PENETROMETER TEST
▽ WATER LEVEL AFTER DRILLING <u>N/A</u>	T = TORVANE SHEAR TEST



The Mannik & Smith Group, Inc.
 2365 Haggerty Road South, Canton, MI 48188
 ph: (734) 397-3100 fax: (734) 397-3131
 www.manniksmithgroup.com

CLIENT <u>City of Ann Arbor</u>	PROJECT NAME <u>2021 Street Resurfacing</u>
PROJECT NUMBER <u>ANNA0039</u>	PROJECT LOCATION <u>Ann Arbor, MI</u>
DATE STARTED <u>1/28/21</u> COMPLETED <u>1/28/21</u>	BORING COORDINATES <u>N/A</u>
DRILLING METHOD <u>3.25" Direct Push Casing w/ 2" split spoon</u>	GROUND ELEVATION _____
DRILLING CONTRACTOR <u>MSG</u>	TOTAL DEPTH <u>5.5 FT</u> BACKFILL <u>Bentonite/soil cuttings/ashalt</u>
DRILL RIG <u>Geoprobe 7822DT</u> HAMMER TYPE <u>Automatic</u>	LOGGED BY <u>RG</u> CHECKED BY <u>ISS</u>
DRILLER <u>RJS</u>	REMARKS <u>2325 Manchester Rd., 5 feet from curb</u>

GRAPHIC LOG	MATERIAL DESCRIPTION	DEPTH (FEET)	SAMPLE TYPE NUMBER	BLOW COUNTS	SPT N VALUE	RECOVERY % (RQD)	DRY DENSITY (PCF)	UNCONF. COMP. STRENGTH (PSF)	MOISTURE CONTENT (%)	▲ SPT N VALUE ▲				ATTERBERG LIMITS		
										10	20	30	40	PL	MC	LL
	ASPHALT (4 inches)	0.0														
	AGGREGATE BASE (4 inches)															
	Medium dense, brown gravelly SAND, little silt, trace clay, damp (FILL)															
		2.5	SS 1	10-9-5	14	67			6							
	Stiff to very stiff, brown sandy CLAY, trace gravel, damp (CL)															
			SS 2	4-5-6	11	67		6500 ^P								
	Very stiff to hard, brown silty CLAY, trace sand and gravel, damp (CL)															
		5.0	SS 3	9-10-10	20	67		9000+ ^P								
	Bottom of borehole at 5.5 feet.															

GEOTECH STANDARD LOG - GINT STD US LAB.GDT - 2/15/21 13:30 - C:\USERS\MSCHIEK\DESKTOP\ANNA0039.GPJ

LEGEND:

▽ WATER LEVEL AT TIME OF DRILLING N/A D = UCS TEST PERFORMED ON DISTURBED SAMPLE
 ▽ WATER LEVEL AT END OF DRILLING N/A P = POCKET PENETROMETER TEST
 ▽ WATER LEVEL AFTER DRILLING N/A T = TORVANE SHEAR TEST



The Mannik & Smith Group, Inc.
 2365 Haggerty Road South, Canton, MI 48188
 ph: (734) 397-3100 fax: (734) 397-3131
 www.manniksmithgroup.com

CLIENT <u>City of Ann Arbor</u>	PROJECT NAME <u>2021 Street Resurfacing</u>
PROJECT NUMBER <u>ANNA0039</u>	PROJECT LOCATION <u>Ann Arbor, MI</u>
DATE STARTED <u>1/29/21</u> COMPLETED <u>1/29/21</u>	BORING COORDINATES <u>N/A</u>
DRILLING METHOD <u>3.25" Direct Push Casing w/ 2" split spoon</u>	GROUND ELEVATION _____
DRILLING CONTRACTOR <u>MSG</u>	TOTAL DEPTH <u>5.5 FT</u> BACKFILL <u>Bentonite/soil cuttings/ashalt</u>
DRILL RIG <u>Geoprobe 7822DT</u> HAMMER TYPE <u>Automatic</u>	LOGGED BY <u>RG</u> CHECKED BY <u>ISS</u>
DRILLER <u>RJS</u>	REMARKS <u>2408 Manchester Rd., 5 feet from curb</u>

GRAPHIC LOG	MATERIAL DESCRIPTION	DEPTH (FEET)	SAMPLE TYPE NUMBER	BLOW COUNTS	SPT N VALUE	RECOVERY % (RQD)	DRY DENSITY (PCF)	UNCONF. COMP. STRENGTH (PSF)	MOISTURE CONTENT (%)	▲ SPT N VALUE ▲				ATTERBERG LIMITS		
										10	20	30	40	PL	MC	LL
[Hatched Box]	ASPHALT (4 inches)	0.0														
[Hatched Box]	AGGREGATE BASE (4 inches)															
[Hatched Box]	Medium dense, brown silty SAND, little clay, trace gravel, damp (FILL)															
		2.5	SS 1	10-12-15	27	67			9							
			SS 2	10-8-7	15	67										
		5.0	SS 3	7-8-8	16	67										
	Bottom of borehole at 5.5 feet.															

GEOTECH STANDARD LOG - GINT STD US LAB.GDT - 2/15/21 13:30 - C:\USERS\MSCHIEK\DESKTOP\ANNA0039.GPJ

LEGEND:

▽ WATER LEVEL AT TIME OF DRILLING <u>N/A</u>	D = UCS TEST PERFORMED ON DISTURBED SAMPLE
▽ WATER LEVEL AT END OF DRILLING <u>N/A</u>	P = POCKET PENETROMETER TEST
▽ WATER LEVEL AFTER DRILLING <u>N/A</u>	T = TORVANE SHEAR TEST



The Mannik & Smith Group, Inc.
 2365 Haggerty Road South, Canton, MI 48188
 ph: (734) 397-3100 fax: (734) 397-3131
 www.manniksmithgroup.com

CLIENT <u>City of Ann Arbor</u>	PROJECT NAME <u>2021 Street Resurfacing</u>
PROJECT NUMBER <u>ANNA0039</u>	PROJECT LOCATION <u>Ann Arbor, MI</u>
DATE STARTED <u>1/29/21</u> COMPLETED <u>1/29/21</u>	BORING COORDINATES <u>N/A</u>
DRILLING METHOD <u>3.25" Direct Push Casing w/ 2" split spoon</u>	GROUND ELEVATION _____
DRILLING CONTRACTOR <u>MSG</u>	TOTAL DEPTH <u>5.5 FT</u> BACKFILL <u>Bentonite/soil cuttings/ashalt</u>
DRILL RIG <u>Geoprobe 7822DT</u> HAMMER TYPE <u>Automatic</u>	LOGGED BY <u>RG</u> CHECKED BY <u>ISS</u>
DRILLER <u>RJS</u>	REMARKS <u>2420 Yorkshire Ave., 7 feet from curb</u>

GRAPHIC LOG	MATERIAL DESCRIPTION	DEPTH (FEET)	SAMPLE TYPE NUMBER	BLOW COUNTS	SPT N VALUE	RECOVERY % (RQD)	DRY DENSITY (PCF)	UNCONF. COMP. STRENGTH (PSF)	MOISTURE CONTENT (%)	▲ SPT N VALUE ▲				ATTERBERG LIMITS			
										10	20	30	40	PL	MC	LL	
	ASPHALT (4 inches)	0.0															
	AGGREGATE BASE (4 inches)																
	Stiff to very stiff, brown sandy CLAY, little gravel, damp (FILL)																
		2.5	SS 1	10-6-7	13	67		4500 ^P	16								
	Very stiff, olive-brown sandy CLAY, little gravel, moist (FILL)																
			SS 2	7-10-12	22	67											
	Medium dense, brown clayey SAND, trace gravel, moist (SC)																
		5.0	SS 3	13-10-8	18	55											
	Bottom of borehole at 5.5 feet.																

GEOTECH STANDARD LOG - GINT STD US LAB.GDT - 2/15/21 13:30 - C:\USERS\MSCHIEK\DESKTOP\ANNA0039.GPJ

LEGEND:
 ▽ WATER LEVEL AT TIME OF DRILLING N/A
 ▽ WATER LEVEL AT END OF DRILLING N/A
 ▽ WATER LEVEL AFTER DRILLING N/A

D = UCS TEST PERFORMED ON DISTURBED SAMPLE
 P = POCKET PENETROMETER TEST
 T = TORVANE SHEAR TEST



The Mannik & Smith Group, Inc.
 2365 Haggerty Road South, Canton, MI 48188
 ph: (734) 397-3100 fax: (734) 397-3131
 www.manniksmithgroup.com

CLIENT <u>City of Ann Arbor</u>	PROJECT NAME <u>2021 Street Resurfacing</u>
PROJECT NUMBER <u>ANNA0039</u>	PROJECT LOCATION <u>Ann Arbor, MI</u>
DATE STARTED <u>1/29/21</u> COMPLETED <u>1/29/21</u>	BORING COORDINATES <u>N/A</u>
DRILLING METHOD <u>3.25" Direct Push Casing w/ 2" split spoon</u>	GROUND ELEVATION _____
DRILLING CONTRACTOR <u>MSG</u>	TOTAL DEPTH <u>5.5 FT</u> BACKFILL <u>Bentonite/soil cuttings/ashalt</u>
DRILL RIG <u>Geoprobe 7822DT</u> HAMMER TYPE <u>Automatic</u>	LOGGED BY <u>RG</u> CHECKED BY <u>ISS</u>
DRILLER <u>RJS</u>	REMARKS <u>2324 Yorkshire Ave., 7 feet from curb</u>

GRAPHIC LOG	MATERIAL DESCRIPTION	DEPTH (FEET)	SAMPLE TYPE NUMBER	BLOW COUNTS	SPT N VALUE	RECOVERY % (RQD)	DRY DENSITY (PCF)	UNCONF. COMP. STRENGTH (PSF)	MOISTURE CONTENT (%)	▲ SPT N VALUE ▲				ATTERBERG LIMITS			
										10	20	30	40	PL	MC	LL	
	ASPHALT (4 inches)	0.0								◇ UNCONF. COMP. STRENGTH (PSF) ◇				□ DRY DENSITY (PCF) □			
	AGGREGATE BASE (4 inches)									2000	4000	6000	8000	100	110	120	130
	Medium dense, brown silty SAND, little gravel and clay, moist (SM)																
		2.5	SS 1	15-12-10	22	67			8								
	Very stiff to hard, brown silty CLAY, trace sand and gravel, damp (CL)																
			SS 2	10-9-8	17	67		9000 ^P									
	@4' stiff, olive-brown, trace organics, moist																
		5.0	SS 3	10-12-11	23	67		2000 ^P									
	Bottom of borehole at 5.5 feet.																

GEOTECH STANDARD LOG - GINT STD US LAB.GDT - 2/15/21 13:30 - C:\USERS\MSCHENK\DESKTOP\ANNA0039.GPJ

LEGEND:		
▽ WATER LEVEL AT TIME OF DRILLING <u>N/A</u>	D = UCS TEST PERFORMED ON DISTURBED SAMPLE	
▽ WATER LEVEL AT END OF DRILLING <u>N/A</u>	P = POCKET PENETROMETER TEST	
▽ WATER LEVEL AFTER DRILLING <u>N/A</u>	T = TORVANE SHEAR TEST	





The Mannik & Smith Group, Inc.
 2365 Haggerty Road South, Canton, MI 48188
 ph: (734) 397-3100 fax: (734) 397-3131
 www.manniksmithgroup.com

CLIENT <u>City of Ann Arbor</u>	PROJECT NAME <u>2021 Street Resurfacing</u>
PROJECT NUMBER <u>ANNA0039</u>	PROJECT LOCATION <u>Ann Arbor, MI</u>
DATE STARTED <u>1/29/21</u> COMPLETED <u>1/29/21</u>	BORING COORDINATES <u>N/A</u>
DRILLING METHOD <u>3.25" Direct Push Casing w/ 2" split spoon</u>	GROUND ELEVATION _____
DRILLING CONTRACTOR <u>MSG</u>	TOTAL DEPTH <u>5.5 FT</u> BACKFILL <u>Bentonite/soil cuttings/ashalt</u>
DRILL RIG <u>Geoprobe 7822DT</u> HAMMER TYPE <u>Automatic</u>	LOGGED BY <u>RG</u> CHECKED BY <u>ISS</u>
DRILLER <u>RJS</u>	REMARKS <u>2416 Dorchester Rd., 6 feet from curb</u>

GRAPHIC LOG	MATERIAL DESCRIPTION	DEPTH (FEET)	SAMPLE TYPE NUMBER	BLOW COUNTS	SPT N VALUE	RECOVERY % (RQD)	DRY DENSITY (PCF)	UNCONF. COMP. STRENGTH (PSF)	MOISTURE CONTENT (%)	▲ SPT N VALUE ▲				ATTERBERG LIMITS		
										10	20	30	40	PL	MC	LL
0.0	ASPHALT (4 inches)															
0.5	AGGREGATE BASE (4 inches)															
1.0	Medium dense, brown silty SAND, little gravel, trace clay, damp (FILL)															
2.5	Medium dense, brown silty SAND, trace gravel and clay, damp (SM)		SS 1	9-10-12	22	67			6							
3.5	Medium dense, brown silty SAND, trace gravel and clay, damp (SM)		SS 2	11-10-9	19	55										
5.0	Medium dense, brown clayey SAND, trace gravel, damp (SC)		SS 3	9-9-7	16	55										
	Bottom of borehole at 5.5 feet.															

GEOTECH STANDARD LOG - GINT STD US LAB.GDT - 2/15/21 13:30 - C:\USERS\MSCHIEK\DESKTOP\ANNA0039.GPJ

LEGEND:

▽ WATER LEVEL AT TIME OF DRILLING <u>N/A</u>	D = UCS TEST PERFORMED ON DISTURBED SAMPLE
▽ WATER LEVEL AT END OF DRILLING <u>N/A</u>	P = POCKET PENETROMETER TEST
▽ WATER LEVEL AFTER DRILLING <u>N/A</u>	T = TORVANE SHEAR TEST



The Mannik & Smith Group, Inc.
 2365 Haggerty Road South, Canton, MI 48188
 ph: (734) 397-3100 fax: (734) 397-3131
 www.manniksmithgroup.com

CLIENT <u>City of Ann Arbor</u>	PROJECT NAME <u>2021 Street Resurfacing</u>
PROJECT NUMBER <u>ANNA0039</u>	PROJECT LOCATION <u>Ann Arbor, MI</u>
DATE STARTED <u>1/29/21</u> COMPLETED <u>1/29/21</u>	BORING COORDINATES <u>N/A</u>
DRILLING METHOD <u>3.25" Direct Push Casing w/ 2" split spoon</u>	GROUND ELEVATION _____
DRILLING CONTRACTOR <u>MSG</u>	TOTAL DEPTH <u>5.5 FT</u> BACKFILL <u>Bentonite/soil cuttings/ashalt</u>
DRILL RIG <u>Geoprobe 7822DT</u> HAMMER TYPE <u>Automatic</u>	LOGGED BY <u>RG</u> CHECKED BY <u>ISS</u>
DRILLER <u>RJS</u>	REMARKS <u>2504 Dorchester Rd., 7 feet from curb</u>

GRAPHIC LOG	MATERIAL DESCRIPTION	DEPTH (FEET)	SAMPLE TYPE NUMBER	BLOW COUNTS	SPT N VALUE	RECOVERY % (RQD)	DRY DENSITY (PCF)	UNCONF. COMP. STRENGTH (PSF)	MOISTURE CONTENT (%)	▲ SPT N VALUE ▲				ATTERBERG LIMITS		
										10	20	30	40	PL	MC	LL
	ASPHALT (4 inches)	0.0														
	AGGREGATE BASE (4 inches)															
	Medium dense, brown gravelly SAND, some silt, damp (FILL)															
		2.5	SS 1	12-13-10	23	55			4							
	Stiff, brown silty CLAY, little sand, trace gravel, damp (CL)		SS 2	7-6-8	14	67										
	Soft, brown sandy CLAY, trace gravel, damp (CL)	5.0	SS 3	6-8-8	16	67		500 ^P								
	Bottom of borehole at 5.5 feet.															

GEOTECH STANDARD LOG - GINT STD US LAB.GDT - 2/15/21 13:30 - C:\USERS\MSCHEIKEN\DESKTOP\ANNA0039.GPJ

LEGEND:

WATER LEVEL AT TIME OF DRILLING N/A
D = UCS TEST PERFORMED ON DISTURBED SAMPLE
 WATER LEVEL AT END OF DRILLING N/A
P = POCKET PENETROMETER TEST
 WATER LEVEL AFTER DRILLING N/A
T = TORVANE SHEAR TEST



The Mannik & Smith Group, Inc.
 2365 Haggerty Road South, Canton, MI 48188
 ph: (734) 397-3100 fax: (734) 397-3131
 www.manniksmithgroup.com

CLIENT <u>City of Ann Arbor</u>	PROJECT NAME <u>2021 Street Resurfacing</u>
PROJECT NUMBER <u>ANNA0039</u>	PROJECT LOCATION <u>Ann Arbor, MI</u>
DATE STARTED <u>1/29/21</u> COMPLETED <u>1/29/21</u>	BORING COORDINATES <u>N/A</u>
DRILLING METHOD <u>3.25" Direct Push Casing w/ 2" split spoon</u>	GROUND ELEVATION _____
DRILLING CONTRACTOR <u>MSG</u>	TOTAL DEPTH <u>5.5 FT</u> BACKFILL <u>Bentonite/soil cuttings/ashalt</u>
DRILL RIG <u>Geoprobe 7822DT</u> HAMMER TYPE <u>Automatic</u>	LOGGED BY <u>RG</u> CHECKED BY <u>ISS</u>
DRILLER <u>RJS</u>	REMARKS <u>2560 Towner Blvd., 7 feet from curb</u>

GRAPHIC LOG	MATERIAL DESCRIPTION	DEPTH (FEET)	SAMPLE TYPE NUMBER	BLOW COUNTS	SPT N VALUE	RECOVERY % (RQD)	DRY DENSITY (PCF)	UNCONF. COMP. STRENGTH (PSF)	MOISTURE CONTENT (%)	▲ SPT N VALUE ▲				ATTERBERG LIMITS		
										10	20	30	40	PL	MC	LL
	ASPHALT (4 inches)	0.0														
	AGGREGATE BASE (4 inches)															
	Medium dense, brown gravelly SAND, some silty, damp (FILL)															
		2.5	SS 1	15-15-8	23	67			7							
	Stiff, brown sandy CLAY, trace gravel, damp (CL)															
		5.0	SS 2	6-6-7	13	67		2500 ^P								
			SS 3	6-7-8	15	67		4000 ^P								
	Bottom of borehole at 5.5 feet.															

GEOTECH STANDARD LOG - GINT STD US LAB.GDT - 2/15/21 13:30 - C:\USERS\MSCHIEK\DESKTOP\ANNA0039.GPJ

LEGEND:
 ▽ WATER LEVEL AT TIME OF DRILLING N/A
 ▽ WATER LEVEL AT END OF DRILLING N/A
 ▽ WATER LEVEL AFTER DRILLING N/A

D = UCS TEST PERFORMED ON DISTURBED SAMPLE
 P = POCKET PENETROMETER TEST
 T = TORVANE SHEAR TEST



The Mannik & Smith Group, Inc.
 2365 Haggerty Road South, Canton, MI 48188
 ph: (734) 397-3100 fax: (734) 397-3131
 www.manniksmithgroup.com

CLIENT <u>City of Ann Arbor</u>	PROJECT NAME <u>2021 Street Resurfacing</u>
PROJECT NUMBER <u>ANNA0039</u>	PROJECT LOCATION <u>Ann Arbor, MI</u>
DATE STARTED <u>1/29/21</u> COMPLETED <u>1/29/21</u>	BORING COORDINATES <u>N/A</u>
DRILLING METHOD <u>3.25" Direct Push Casing w/ 2" split spoon</u>	GROUND ELEVATION _____
DRILLING CONTRACTOR <u>MSG</u>	TOTAL DEPTH <u>5.5 FT</u> BACKFILL <u>Bentonite/soil cuttings/ashalt</u>
DRILL RIG <u>Geoprobe 7822DT</u> HAMMER TYPE <u>Automatic</u>	LOGGED BY <u>RG</u> CHECKED BY <u>ISS</u>
DRILLER <u>RJS</u>	REMARKS <u>2491 Towner Blvd., 12 feet from curb</u>

GRAPHIC LOG	MATERIAL DESCRIPTION	DEPTH (FEET)	SAMPLE TYPE NUMBER	BLOW COUNTS	SPT N VALUE	RECOVERY % (RQD)	DRY DENSITY (PCF)	UNCONF. COMP. STRENGTH (PSF)	MOISTURE CONTENT (%)	▲ SPT N VALUE ▲				ATTERBERG LIMITS		
										10	20	30	40	PL	MC	LL
	ASPHALT (4 inches)	0.0														
	AGGREGATE BASE (4 inches)															
	Medium dense, brown gravelly SAND, some silt, damp (FILL)															
		2.5	SS 1	10-8-6	14	67			5							
	Stiff, brown sandy CLAY, trace gravel, damp (FILL)															
			SS 2	5-6-7	13	67		2000 ^P								
	@4' very stiff, dark brown, trace organics															
		5.0	SS 3	7-8-9	17	67		4000 ^P								
	Bottom of borehole at 5.5 feet.															

GEOTECH STANDARD LOG - GINT STD US LAB.GDT - 2/15/21 13:31 - C:\USERS\MSCHIEK\DESKTOP\ANNA0039.GPJ

LEGEND:		
▽ WATER LEVEL AT TIME OF DRILLING <u>N/A</u>		D = UCS TEST PERFORMED ON DISTURBED SAMPLE
▽ WATER LEVEL AT END OF DRILLING <u>N/A</u>		P = POCKET PENETROMETER TEST
▽ WATER LEVEL AFTER DRILLING <u>N/A</u>		T = TORVANE SHEAR TEST





The Mannik & Smith Group, Inc.
 2365 Haggerty Road South, Canton, MI 48188
 ph: (734) 397-3100 fax: (734) 397-3131
 www.manniksmithgroup.com

CLIENT <u>City of Ann Arbor</u>	PROJECT NAME <u>2021 Street Resurfacing</u>
PROJECT NUMBER <u>ANNA0039</u>	PROJECT LOCATION <u>Ann Arbor, MI</u>
DATE STARTED <u>1/29/21</u> COMPLETED <u>1/29/21</u>	BORING COORDINATES <u>N/A</u>
DRILLING METHOD <u>3.25" Direct Push Casing w/ 2" split spoon</u>	GROUND ELEVATION _____
DRILLING CONTRACTOR <u>MSG</u>	TOTAL DEPTH <u>5.5 FT</u> BACKFILL <u>Bentonite/soil cuttings/ashalt</u>
DRILL RIG <u>Geoprobe 7822DT</u> HAMMER TYPE <u>Automatic</u>	LOGGED BY <u>RG</u> CHECKED BY <u>ISS</u>
DRILLER <u>RJS</u>	REMARKS <u>2532 Towner Blvd., 8 feet from curb</u>

GRAPHIC LOG	MATERIAL DESCRIPTION	DEPTH (FEET)	SAMPLE TYPE NUMBER	BLOW COUNTS	SPT N VALUE	RECOVERY % (RQD)	DRY DENSITY (PCF)	UNCONF. COMP. STRENGTH (PSF)	MOISTURE CONTENT (%)	▲ SPT N VALUE ▲				ATTERBERG LIMITS		
										10	20	30	40	PL	MC	LL
	ASPHALT (4 inches)	0.0														
	AGGREGATE BASE (4 inches)															
	ASPHALT/millings (FILL)															
		2.5	SS 1	15-14-10	24	55			9							
	Very stiff, brown silty CLAY, little sand, trace gravel, damp (CL)		SS 2	6-8-10	18	67		4500 ^P								
	@4' blocky/fractured		SS 3	10-10-15	25	67										
	Bottom of borehole at 5.5 feet.	5.0														

GEOTECH STANDARD LOG - GINT STD US LAB.GDT - 2/15/21 13:31 - C:\USERS\MSCHIEK\DESKTOP\ANNA0039.GPJ

LEGEND:
 ▽ WATER LEVEL AT TIME OF DRILLING N/A D = UCS TEST PERFORMED ON DISTURBED SAMPLE
 ▽ WATER LEVEL AT END OF DRILLING N/A P = POCKET PENETROMETER TEST
 ▽ WATER LEVEL AFTER DRILLING N/A T = TORVANE SHEAR TEST





The Mannik & Smith Group, Inc.
 2365 Haggerty Road South, Canton, MI 48188
 ph: (734) 397-3100 fax: (734) 397-3131
 www.manniksmithgroup.com

CLIENT <u>City of Ann Arbor</u>	PROJECT NAME <u>2021 Street Resurfacing</u>
PROJECT NUMBER <u>ANNA0039</u>	PROJECT LOCATION <u>Ann Arbor, MI</u>
DATE STARTED <u>2/1/21</u> COMPLETED <u>2/1/21</u>	BORING COORDINATES <u>N/A</u>
DRILLING METHOD <u>3.25" Direct Push Casing w/ 2" split spoon</u>	GROUND ELEVATION _____
DRILLING CONTRACTOR <u>MSG</u>	TOTAL DEPTH <u>5.5 FT</u> BACKFILL <u>Bentonite/soil cuttings/ashalt</u>
DRILL RIG <u>Geoprobe 7822DT</u> HAMMER TYPE <u>Automatic</u>	LOGGED BY <u>RG</u> CHECKED BY <u>ISS</u>
DRILLER <u>RJS</u>	REMARKS <u>2606 Cranbrook Rd., 6 feet from curb</u>

GRAPHIC LOG	MATERIAL DESCRIPTION	DEPTH (FEET)	SAMPLE TYPE NUMBER	BLOW COUNTS	SPT N VALUE	RECOVERY % (RQD)	DRY DENSITY (PCF)	UNCONF. COMP. STRENGTH (PSF)	MOISTURE CONTENT (%)	▲ SPT N VALUE ▲				ATTERBERG LIMITS		
										10	20	30	40	PL	MC	LL
	ASPHALT (4 inches)	0.0														
	AGGREGATE BASE (4 inches)															
	Medium stiff, brown sandy CLAY, trace gravel, damp (FILL)															
		2.5	SS 1	15-4-3	7	55			11							
	Hard, brown silty CLAY, blocky/fractured, trace sand and gravel, damp (CL)															
	@4' very stiff															
		5.0	SS 2	4-5-6	11	67		9000 ^P								
			SS 3	8-9-10	19	67		5000 ^P								
	Bottom of borehole at 5.5 feet.															

GEOTECH STANDARD LOG - GINT STD US LAB.GDT - 2/15/21 13:31 - C:\USERS\MSCHIEK\DESKTOP\ANNA0039.GPJ

LEGEND:		
▽ WATER LEVEL AT TIME OF DRILLING <u>N/A</u>	D = UCS TEST PERFORMED ON DISTURBED SAMPLE	
▽ WATER LEVEL AT END OF DRILLING <u>N/A</u>	P = POCKET PENETROMETER TEST	
▽ WATER LEVEL AFTER DRILLING <u>N/A</u>	T = TORVANE SHEAR TEST	





The Mannik & Smith Group, Inc.
 2365 Haggerty Road South, Canton, MI 48188
 ph: (734) 397-3100 fax: (734) 397-3131
 www.manniksmithgroup.com

CLIENT <u>City of Ann Arbor</u>	PROJECT NAME <u>2021 Street Resurfacing</u>
PROJECT NUMBER <u>ANNA0039</u>	PROJECT LOCATION <u>Ann Arbor, MI</u>
DATE STARTED <u>2/1/21</u> COMPLETED <u>2/1/21</u>	BORING COORDINATES <u>N/A</u>
DRILLING METHOD <u>3.25" Direct Push Casing w/ 2" split spoon</u>	GROUND ELEVATION _____
DRILLING CONTRACTOR <u>MSG</u>	TOTAL DEPTH <u>5.5 FT</u> BACKFILL <u>Bentonite/soil cuttings/ashalt</u>
DRILL RIG <u>Geoprobe 7822DT</u> HAMMER TYPE <u>Automatic</u>	LOGGED BY <u>RG</u> CHECKED BY <u>ISS</u>
DRILLER <u>RJS</u>	REMARKS <u>2711 Cranbrook Rd., 8 feet from curb</u>

GRAPHIC LOG	MATERIAL DESCRIPTION	DEPTH (FEET)	SAMPLE TYPE NUMBER	BLOW COUNTS	SPT N VALUE	RECOVERY % (RQD)	DRY DENSITY (PCF)	UNCONF. COMP. STRENGTH (PSF)	MOISTURE CONTENT (%)	▲ SPT N VALUE ▲				ATTERBERG LIMITS			
										10	20	30	40	PL	MC	LL	
	ASPHALT (4 inches)	0.0															
	AGGREGATE BASE (4 inches)																
	Very stiff, brown sandy CLAY, little gravel, damp (FILL)																
		2.5	SS 1	15-12-10	22	67			8								
	Medium dense, brown clayey SAND, trace gravel, damp (SC)																
			SS 2	10-10-10	20	67											
	Hard, brown silty CLAY, trace sand, damp (CL)																
		5.0	SS 3	10-8-5	13	67		9000+ ^P									
	Bottom of borehole at 5.5 feet.																

GEOTECH STANDARD LOG - GINT STD US LAB.GDT - 2/15/21 13:31 - C:\USERS\MSCHIEK\DESKTOP\ANNA0039.GPJ

LEGEND:	
▽ WATER LEVEL AT TIME OF DRILLING <u>N/A</u>	D = UCS TEST PERFORMED ON DISTURBED SAMPLE
▽ WATER LEVEL AT END OF DRILLING <u>N/A</u>	P = POCKET PENETROMETER TEST
▽ WATER LEVEL AFTER DRILLING <u>N/A</u>	T = TORVANE SHEAR TEST





The Mannik & Smith Group, Inc.
 2365 Haggerty Road South, Canton, MI 48188
 ph: (734) 397-3100 fax: (734) 397-3131
 www.manniksmithgroup.com

CLIENT <u>City of Ann Arbor</u>	PROJECT NAME <u>2021 Street Resurfacing</u>
PROJECT NUMBER <u>ANNA0039</u>	PROJECT LOCATION <u>Ann Arbor, MI</u>
DATE STARTED <u>2/1/21</u> COMPLETED <u>2/1/21</u>	BORING COORDINATES <u>N/A</u>
DRILLING METHOD <u>3.25" Direct Push Casing w/ 2" split spoon</u>	GROUND ELEVATION _____
DRILLING CONTRACTOR <u>MSG</u>	TOTAL DEPTH <u>5.5 FT</u> BACKFILL <u>Bentonite/soil cuttings/ashalt</u>
DRILL RIG <u>Geoprobe 7822DT</u> HAMMER TYPE <u>Automatic</u>	LOGGED BY <u>RG</u> CHECKED BY <u>ISS</u>
DRILLER <u>RJS</u>	REMARKS <u>2726 Cranbrook Rd., 8 feet from curb</u>

GRAPHIC LOG	MATERIAL DESCRIPTION	DEPTH (FEET)	SAMPLE TYPE NUMBER	BLOW COUNTS	SPT N VALUE	RECOVERY % (RQD)	DRY DENSITY (PCF)	UNCONF. COMP. STRENGTH (PSF)	MOISTURE CONTENT (%)	▲ SPT N VALUE ▲				ATTERBERG LIMITS		
										10	20	30	40	PL	MC	LL
	ASPHALT (4 inches)	0.0														
	AGGREGATE BASE (4 inches)															
	Medium dense, brown clayey SAND, little gravel, damp (FILL)															
		2.5	SS 1	15-15-13	28	67			9							
			SS 2	7-7-7	14	67										
	Medium dense, brown silty SAND, trace clay, damp (FILL)															
		5.0	SS 3	10-8-8	16	55		2500 ^P								
	Stiff, brown silty CLAY, trace sand, damp (CL)															
	Bottom of borehole at 5.5 feet.															

GEOTECH STANDARD LOG - GINT STD US LAB.GDT - 2/15/21 13:31 - C:\USERS\MSCHIEK\DESKTOP\ANNA0039.GPJ

LEGEND:

▽ WATER LEVEL AT TIME OF DRILLING <u>N/A</u>	D = UCS TEST PERFORMED ON DISTURBED SAMPLE
▽ WATER LEVEL AT END OF DRILLING <u>N/A</u>	P = POCKET PENETROMETER TEST
▽ WATER LEVEL AFTER DRILLING <u>N/A</u>	T = TORVANE SHEAR TEST



The Mannik & Smith Group, Inc.
 2365 Haggerty Road South, Canton, MI 48188
 ph: (734) 397-3100 fax: (734) 397-3131
 www.manniksmithgroup.com

CLIENT <u>City of Ann Arbor</u>	PROJECT NAME <u>2021 Street Resurfacing</u>
PROJECT NUMBER <u>ANNA0039</u>	PROJECT LOCATION <u>Ann Arbor, MI</u>
DATE STARTED <u>2/1/21</u> COMPLETED <u>2/1/21</u>	BORING COORDINATES <u>N/A</u>
DRILLING METHOD <u>3.25" Direct Push Casing w/ 2" split spoon</u>	GROUND ELEVATION _____
DRILLING CONTRACTOR <u>MSG</u>	TOTAL DEPTH <u>5.5 FT</u> BACKFILL <u>Bentonite/soil cuttings/ashalt</u>
DRILL RIG <u>Geoprobe 7822DT</u> HAMMER TYPE <u>Automatic</u>	LOGGED BY <u>RG</u> CHECKED BY <u>ISS</u>
DRILLER <u>RJS</u>	REMARKS <u>2815 Cranbrook Rd., 8 feet from curb</u>

GRAPHIC LOG	MATERIAL DESCRIPTION	DEPTH (FEET)	SAMPLE TYPE NUMBER	BLOW COUNTS	SPT N VALUE	RECOVERY % (RQD)	DRY DENSITY (PCF)	UNCONF. COMP. STRENGTH (PSF)	MOISTURE CONTENT (%)	▲ SPT N VALUE ▲				ATTERBERG LIMITS		
										10	20	30	40	PL	MC	LL
	ASPHALT (4 inches)	0.0														
	AGGREGATE BASE (4 inches)															
	Medium dense, brown silty SAND, little gravel and clay, dry (FILL)															
		2.5	SS 1	10-10-8	18	67			6							
			SS 2	8-8-8	16	55										
	Hard, brown sandy CLAY, trace gravel, damp (FILL)															
		5.0	SS 3	8-6-5	11	67		9000+ ^P								
	Bottom of borehole at 5.5 feet.															

GEOTECH STANDARD LOG - GINT STD US LAB.GDT - 2/15/21 13:31 - C:\USERS\MSCHIEK\DESKTOP\ANNA0039.GPJ

LEGEND:

▽ WATER LEVEL AT TIME OF DRILLING N/A D = UCS TEST PERFORMED ON DISTURBED SAMPLE
 ▽ WATER LEVEL AT END OF DRILLING N/A P = POCKET PENETROMETER TEST
 ▽ WATER LEVEL AFTER DRILLING N/A T = TORVANE SHEAR TEST



The Mannik & Smith Group, Inc.
 2365 Haggerty Road South, Canton, MI 48188
 ph: (734) 397-3100 fax: (734) 397-3131
 www.manniksmithgroup.com

CLIENT <u>City of Ann Arbor</u>	PROJECT NAME <u>2021 Street Resurfacing</u>
PROJECT NUMBER <u>ANNA0039</u>	PROJECT LOCATION <u>Ann Arbor, MI</u>
DATE STARTED <u>2/5/21</u> COMPLETED <u>2/5/21</u>	BORING COORDINATES <u>N/A</u>
DRILLING METHOD <u>3.25" Direct Push Casing w/ 2" split spoon</u>	GROUND ELEVATION _____
DRILLING CONTRACTOR <u>MSG</u>	TOTAL DEPTH <u>5.5 FT</u> BACKFILL <u>Bentonite/soil cuttings/ashalt</u>
DRILL RIG <u>Geoprobe 7822DT</u> HAMMER TYPE <u>Automatic</u>	LOGGED BY <u>RG</u> CHECKED BY <u>ISS</u>
DRILLER <u>RJS</u>	REMARKS <u>3299 St. Aubin Ave.</u>

GRAPHIC LOG	MATERIAL DESCRIPTION	DEPTH (FEET)	SAMPLE TYPE NUMBER	BLOW COUNTS	SPT N VALUE	RECOVERY % (RQD)	DRY DENSITY (PCF)	UNCONF. COMP. STRENGTH (PSF)	MOISTURE CONTENT (%)	▲ SPT N VALUE ▲				ATTERBERG LIMITS		
										10	20	30	40	PL	MC	LL
	ASPHALT (4 inches)	0.0														
	AGGREGATE BASE (4 inches)															
	Medium stiff to stiff, brown sandy CLAY, trace gravel and organics, damp (FILL)															
	@2.5' soft	2.5	SS 1	6-6-2	8	67		2500 ^P	15							
			SS 2	8-2-2	4	67		2500 ^P								
	Soft, brown silty CLAY, trace sand and gravel, moist (CL)		SS 3	5-2-5	7	67		500 ^P								
	Bottom of borehole at 5.5 feet.	5.0														

GEOTECH STANDARD LOG - GINT STD US LAB.GDT - 2/15/21 13:31 - C:\USERS\MSCHIEK\DESKTOP\ANNA0039.GPJ

LEGEND:

▽ WATER LEVEL AT TIME OF DRILLING N/A D = UCS TEST PERFORMED ON DISTURBED SAMPLE

▽ WATER LEVEL AT END OF DRILLING N/A P = POCKET PENETROMETER TEST

▽ WATER LEVEL AFTER DRILLING N/A T = TORVANE SHEAR TEST



The Mannik & Smith Group, Inc.
 2365 Haggerty Road South, Canton, MI 48188
 ph: (734) 397-3100 fax: (734) 397-3131
 www.manniksmithgroup.com

CLIENT <u>City of Ann Arbor</u>	PROJECT NAME <u>2021 Street Resurfacing</u>
PROJECT NUMBER <u>ANNA0039</u>	PROJECT LOCATION <u>Ann Arbor, MI</u>
DATE STARTED <u>2/5/21</u> COMPLETED <u>2/5/21</u>	BORING COORDINATES <u>N/A</u>
DRILLING METHOD <u>3.25" Direct Push Casing w/ 2" split spoon</u>	GROUND ELEVATION _____
DRILLING CONTRACTOR <u>MSG</u>	TOTAL DEPTH <u>5.5 FT</u> BACKFILL <u>Bentonite/soil cuttings/ashalt</u>
DRILL RIG <u>Geoprobe 7822DT</u> HAMMER TYPE <u>Automatic</u>	LOGGED BY <u>RG</u> CHECKED BY <u>ISS</u>
DRILLER <u>RJS</u>	REMARKS <u>3101 St. Aubin Ave.</u>

GRAPHIC LOG	MATERIAL DESCRIPTION	DEPTH (FEET)	SAMPLE TYPE NUMBER	BLOW COUNTS	SPT N VALUE	RECOVERY % (RQD)	DRY DENSITY (PCF)	UNCONF. COMP. STRENGTH (PSF)	MOISTURE CONTENT (%)	▲ SPT N VALUE ▲				ATTERBERG LIMITS		
										10	20	30	40	PL	MC	LL
	ASPHALT (4 inches)	0.0														
	AGGREGATE BASE (4 inches)															
	Medium stiff, dark brown silty CLAY, little sand, trace gravel, organics, ash, and slag, damp (FILL)															
	@2.5' soft, no ash or slag	2.5	SS 1	5-8-8	16	67		1500 ^P	22	◇						
			SS 2	4-8-6	14	67		500 ^P		◇						
	Medium stiff to stiff, brown silty CLAY, little sand, trace gravel, damp (FILL) (CL)															
		5.0	SS 3	5-4-4	8	67		1500 ^P		▲						
	Bottom of borehole at 5.5 feet.															

GEOTECH STANDARD LOG - GINT STD US LAB.GDT - 2/15/21 13:31 - C:\USERS\MSCHIEK\DESKTOP\ANNA0039.GPJ

LEGEND:		
▽ WATER LEVEL AT TIME OF DRILLING <u>N/A</u>	D = UCS TEST PERFORMED ON DISTURBED SAMPLE	
▽ WATER LEVEL AT END OF DRILLING <u>N/A</u>	P = POCKET PENETROMETER TEST	
▽ WATER LEVEL AFTER DRILLING <u>N/A</u>	T = TORVANE SHEAR TEST	





The Mannik & Smith Group, Inc.
 2365 Haggerty Road South, Canton, MI 48188
 ph: (734) 397-3100 fax: (734) 397-3131
 www.manniksmithgroup.com

CLIENT <u>City of Ann Arbor</u>	PROJECT NAME <u>2021 Street Resurfacing</u>
PROJECT NUMBER <u>ANNA0039</u>	PROJECT LOCATION <u>Ann Arbor, MI</u>
DATE STARTED <u>2/1/21</u> COMPLETED <u>2/1/21</u>	BORING COORDINATES <u>N/A</u>
DRILLING METHOD <u>3.25" Direct Push Casing w/ 2" split spoon</u>	GROUND ELEVATION _____
DRILLING CONTRACTOR <u>MSG</u>	TOTAL DEPTH <u>5.5 FT</u> BACKFILL <u>Bentonite/soil cuttings/ashalt</u>
DRILL RIG <u>Geoprobe 7822DT</u> HAMMER TYPE <u>Automatic</u>	LOGGED BY <u>RG</u> CHECKED BY <u>ISS</u>
DRILLER <u>RJS</u>	REMARKS <u>2818 Marshall St., 7 feet from curb</u>

GRAPHIC LOG	MATERIAL DESCRIPTION	DEPTH (FEET)	SAMPLE TYPE NUMBER	BLOW COUNTS	SPT N VALUE	RECOVERY % (RQD)	DRY DENSITY (PCF)	UNCONF. COMP. STRENGTH (PSF)	MOISTURE CONTENT (%)	▲ SPT N VALUE ▲				ATTERBERG LIMITS		
										10	20	30	40	PL	MC	LL
	ASPHALT (4 inches)	0.0														
	AGGREGATE BASE (4 inches)															
	Medium dense, black silty SAND, trace gravel, damp (ashalt-based FILL/millings)		SS 1	10-8-10	18	67			4							
	Medium dense, brown clayey SAND, little gravel, moist (FILL)	2.5	SS 2	6-9-9	18	67										
	Very stiff, dark brown silty CLAY, little sand, trace organics, damp (FILL)	5.0	SS 3	8-9-10	19	67		4000 ^P								
	Bottom of borehole at 5.5 feet.															

GEOTECH STANDARD LOG - GINT STD US LAB.GDT - 2/15/21 13:31 - C:\USERS\MSCHIEK\DESKTOP\ANNA0039.GPJ

LEGEND:	
▽ WATER LEVEL AT TIME OF DRILLING <u>N/A</u>	D = UCS TEST PERFORMED ON DISTURBED SAMPLE
▽ WATER LEVEL AT END OF DRILLING <u>N/A</u>	P = POCKET PENETROMETER TEST
▽ WATER LEVEL AFTER DRILLING <u>N/A</u>	T = TORVANE SHEAR TEST





The Mannik & Smith Group, Inc.
 2365 Haggerty Road South, Canton, MI 48188
 ph: (734) 397-3100 fax: (734) 397-3131
 www.manniksmithgroup.com

CLIENT <u>City of Ann Arbor</u>	PROJECT NAME <u>2021 Street Resurfacing</u>
PROJECT NUMBER <u>ANNA0039</u>	PROJECT LOCATION <u>Ann Arbor, MI</u>
DATE STARTED <u>2/1/21</u> COMPLETED <u>2/1/21</u>	BORING COORDINATES <u>N/A</u>
DRILLING METHOD <u>3.25" Direct Push Casing w/ 2" split spoon</u>	GROUND ELEVATION _____
DRILLING CONTRACTOR <u>MSG</u>	TOTAL DEPTH <u>5.5 FT</u> BACKFILL <u>Bentonite/soil cuttings/ashalt</u>
DRILL RIG <u>Geoprobe 7822DT</u> HAMMER TYPE <u>Automatic</u>	LOGGED BY <u>RG</u> CHECKED BY <u>ISS</u>
DRILLER <u>RJS</u>	REMARKS <u>2847 Marshall St., 8 feet from curb</u>

GRAPHIC LOG	MATERIAL DESCRIPTION	DEPTH (FEET)	SAMPLE TYPE NUMBER	BLOW COUNTS	SPT N VALUE	RECOVERY % (RQD)	DRY DENSITY (PCF)	UNCONF. COMP. STRENGTH (PSF)	MOISTURE CONTENT (%)	▲ SPT N VALUE ▲				ATTERBERG LIMITS		
										10	20	30	40	PL	MC	LL
	ASPHALT (4 inches)	0.0														
	AGGREGATE BASE (4 inches)															
	Medium dense, brown and black silty SAND, little gravel, dry (asphalt-based FILL/millings)		SS 1	10-7-8	15	55			5							
	Medium dense, brown silty SAND, little gravel and clay, moist (FILL)	2.5	SS 2	7-7-6	13	67										
	Very stiff, dark brown silty CLAY, little sand, trace gravel and organics, damp (FILL)		SS 3	9-10-9	19	67		5000 ^P								
	Bottom of borehole at 5.5 feet.	5.0														

LEGEND:

- ▽ WATER LEVEL AT TIME OF DRILLING N/A
- ▽ WATER LEVEL AT END OF DRILLING N/A
- ▽ WATER LEVEL AFTER DRILLING N/A

D = UCS TEST PERFORMED ON DISTURBED SAMPLE

P = POCKET PENETROMETER TEST

T = TORVANE SHEAR TEST



GEOTECH STANDARD LOG - GINT STD US LAB.GDT - 2/15/21 13:31 - C:\USERS\MSCHIEK\DESKTOP\ANNA0039.GPJ



The Mannik & Smith Group, Inc.
 2365 Haggerty Road South, Canton, MI 48188
 ph: (734) 397-3100 fax: (734) 397-3131
 www.manniksmithgroup.com

CLIENT <u>City of Ann Arbor</u>	PROJECT NAME <u>2021 Street Resurfacing</u>
PROJECT NUMBER <u>ANNA0039</u>	PROJECT LOCATION <u>Ann Arbor, MI</u>
DATE STARTED <u>2/1/21</u> COMPLETED <u>2/1/21</u>	BORING COORDINATES <u>N/A</u>
DRILLING METHOD <u>3.25" Direct Push Casing w/ 2" split spoon</u>	GROUND ELEVATION _____
DRILLING CONTRACTOR <u>MSG</u>	TOTAL DEPTH <u>5.5 FT</u> BACKFILL <u>Bentonite/soil cuttings/ashalt</u>
DRILL RIG <u>Geoprobe 7822DT</u> HAMMER TYPE <u>Automatic</u>	LOGGED BY <u>RG</u> CHECKED BY <u>ISS</u>
DRILLER <u>RJS</u>	REMARKS <u>2918 Marshall St., 10 feet from curb</u>

GRAPHIC LOG	MATERIAL DESCRIPTION	DEPTH (FEET)	SAMPLE TYPE NUMBER	BLOW COUNTS	SPT N VALUE	RECOVERY % (RQD)	DRY DENSITY (PCF)	UNCONF. COMP. STRENGTH (PSF)	MOISTURE CONTENT (%)	▲ SPT N VALUE ▲				ATTERBERG LIMITS		
										10	20	30	40	PL	MC	LL
	ASPHALT (4 inches)	0.0														
	AGGREGATE BASE (4 inches)															
	Medium dense, brown silty SAND, trace gravel and clay, damp (FILL)															
		2.5	SS 1	10-9-6	15	67			8							
	Very stiff, brown silty CLAY, trace sand, gravel, and organics, damp (FILL)															
			SS 2	6-8-8	16	67		5000 ^P								
	Very stiff to hard, brown mottled gray silty CLAY, trace sand and gravel, damp (CL)															
		5.0	SS 3	10-10-12	22	67		9000+ ^P								
	Bottom of borehole at 5.5 feet.															

GEOTECH STANDARD LOG - GINT STD US LAB.GDT - 2/15/21 13:31 - C:\USERS\MSCHIEK\DESKTOP\ANNA0039.GPJ

LEGEND:	
▽ WATER LEVEL AT TIME OF DRILLING <u>N/A</u>	D = UCS TEST PERFORMED ON DISTURBED SAMPLE
▽ WATER LEVEL AT END OF DRILLING <u>N/A</u>	P = POCKET PENETROMETER TEST
▽ WATER LEVEL AFTER DRILLING <u>N/A</u>	T = TORVANE SHEAR TEST





The Mannik & Smith Group, Inc.
 2365 Haggerty Road South, Canton, MI 48188
 ph: (734) 397-3100 fax: (734) 397-3131
 www.manniksmithgroup.com

CLIENT <u>City of Ann Arbor</u>	PROJECT NAME <u>2021 Street Resurfacing</u>
PROJECT NUMBER <u>ANNA0039</u>	PROJECT LOCATION <u>Ann Arbor, MI</u>
DATE STARTED <u>2/1/21</u> COMPLETED <u>2/1/21</u>	BORING COORDINATES <u>N/A</u>
DRILLING METHOD <u>3.25" Direct Push Casing w/ 2" split spoon</u>	GROUND ELEVATION _____
DRILLING CONTRACTOR <u>MSG</u>	TOTAL DEPTH <u>5.5 FT</u> BACKFILL <u>Bentonite/soil cuttings/ashalt</u>
DRILL RIG <u>Geoprobe 7822DT</u> HAMMER TYPE <u>Automatic</u>	LOGGED BY <u>RG</u> CHECKED BY <u>ISS</u>
DRILLER <u>RJS</u>	REMARKS <u>2959 Marshall St., 8 feet from curb</u>

GRAPHIC LOG	MATERIAL DESCRIPTION	DEPTH (FEET)	SAMPLE TYPE NUMBER	BLOW COUNTS	SPT N VALUE	RECOVERY % (RQD)	DRY DENSITY (PCF)	UNCONF. COMP. STRENGTH (PSF)	MOISTURE CONTENT (%)	▲ SPT N VALUE ▲				ATTERBERG LIMITS		
										10	20	30	40	PL	MC	LL
	ASPHALT (4 inches)	0.0														
	AGGREGATE BASE (4 inches)															
	Medium dense, brown silty SAND, little gravel and clay, damp (FILL)															
		2.5	SS 1	10-10-5	15	67			8							
	Stiff, dark brown silty CLAY, trace sand, gravel, and organics, damp (FILL)															
			SS 2	5-5-7	12	67		3500 ^P								
	Very stiff, brown mottled gray silty CLAY, trace sand, gravel, and organics, damp (CL)															
		5.0	SS 3	7-8-8	16	67		6000 ^P								
	Bottom of borehole at 5.5 feet.															

GEOTECH STANDARD LOG - GINT STD US LAB.GDT - 2/15/21 13:31 - C:\USERS\MSCHIEK\DESKTOP\ANNA0039.GPJ

LEGEND:	
▽ WATER LEVEL AT TIME OF DRILLING <u>N/A</u>	D = UCS TEST PERFORMED ON DISTURBED SAMPLE
▽ WATER LEVEL AT END OF DRILLING <u>N/A</u>	P = POCKET PENETROMETER TEST
▽ WATER LEVEL AFTER DRILLING <u>N/A</u>	T = TORVANE SHEAR TEST





The Mannik & Smith Group, Inc.
 2365 Haggerty Road South, Canton, MI 48188
 ph: (734) 397-3100 fax: (734) 397-3131
 www.manniksmithgroup.com

CLIENT <u>City of Ann Arbor</u>	PROJECT NAME <u>2021 Street Resurfacing</u>
PROJECT NUMBER <u>ANNA0039</u>	PROJECT LOCATION <u>Ann Arbor, MI</u>
DATE STARTED <u>2/1/21</u> COMPLETED <u>2/1/21</u>	BORING COORDINATES <u>N/A</u>
DRILLING METHOD <u>3.25" Direct Push Casing w/ 2" split spoon</u>	GROUND ELEVATION _____
DRILLING CONTRACTOR <u>MSG</u>	TOTAL DEPTH <u>5.5 FT</u> BACKFILL <u>Bentonite/soil cuttings/ashalt</u>
DRILL RIG <u>Geoprobe 7822DT</u> HAMMER TYPE <u>Automatic</u>	LOGGED BY <u>RG</u> CHECKED BY <u>ISS</u>
DRILLER <u>RJS</u>	REMARKS <u>3476 Eddy St., 8 feet from curb</u>

GRAPHIC LOG	MATERIAL DESCRIPTION	DEPTH (FEET)	SAMPLE TYPE NUMBER	BLOW COUNTS	SPT N VALUE	RECOVERY % (RQD)	DRY DENSITY (PCF)	UNCONF. COMP. STRENGTH (PSF)	MOISTURE CONTENT (%)	▲ SPT N VALUE ▲				ATTERBERG LIMITS			
										10	20	30	40	PL	MC	LL	
										◇ UNCONF. COMP. STRENGTH (PSF) ◇				□ DRY DENSITY (PCF) □			
	ASPHALT (4 inches)	0.0								2000	4000	6000	8000	100	110	120	130
	AGGREGATE BASE (4 inches)																
	Medium dense, brown and black silty SAND, little gravel and asphalt fragments/millings, damp (FILL)		SS 1	10-9-7	16	67			5								
	Medium dense, brown clayey SAND, little gravel, damp (FILL)	2.5	SS 2	5-5-6	11	55											
	Hard, brown mottled gray silty CLAY, trace sand and gravel, damp (CL)		SS 3	6-7-8	15	55		9000+ ^P									
	Bottom of borehole at 5.5 feet.	5.0															

GEOTECH STANDARD LOG - GINT STD US LAB.GDT - 2/15/21 13:31 - C:\USERS\MSCHIEK\DESKTOP\ANNA0039.GPJ

LEGEND:

▽ WATER LEVEL AT TIME OF DRILLING <u>N/A</u>	D = UCS TEST PERFORMED ON DISTURBED SAMPLE
▽ WATER LEVEL AT END OF DRILLING <u>N/A</u>	P = POCKET PENETROMETER TEST
▽ WATER LEVEL AFTER DRILLING <u>N/A</u>	T = TORVANE SHEAR TEST



The Mannik & Smith Group, Inc.
 2365 Haggerty Road South, Canton, MI 48188
 ph: (734) 397-3100 fax: (734) 397-3131
 www.manniksmithgroup.com

CLIENT <u>City of Ann Arbor</u>	PROJECT NAME <u>2021 Street Resurfacing</u>
PROJECT NUMBER <u>ANNA0039</u>	PROJECT LOCATION <u>Ann Arbor, MI</u>
DATE STARTED <u>2/1/21</u> COMPLETED <u>2/1/21</u>	BORING COORDINATES <u>N/A</u>
DRILLING METHOD <u>3.25" Direct Push Casing w/ 2" split spoon</u>	GROUND ELEVATION _____
DRILLING CONTRACTOR <u>MSG</u>	TOTAL DEPTH <u>5.5 FT</u> BACKFILL <u>Bentonite/soil cuttings/ashalt</u>
DRILL RIG <u>Geoprobe 7822DT</u> HAMMER TYPE <u>Automatic</u>	LOGGED BY <u>RG</u> CHECKED BY <u>ISS</u>
DRILLER <u>RJS</u>	REMARKS <u>2814 Verle Ave., 7 feet from curb</u>

GRAPHIC LOG	MATERIAL DESCRIPTION	DEPTH (FEET)	SAMPLE TYPE NUMBER	BLOW COUNTS	SPT N VALUE	RECOVERY % (RQD)	DRY DENSITY (PCF)	UNCONF. COMP. STRENGTH (PSF)	MOISTURE CONTENT (%)	▲ SPT N VALUE ▲				ATTERBERG LIMITS		
										10	20	30	40	PL	MC	LL
	ASPHALT (4 inches)	0.0														
	AGGREGATE BASE (4 inches)															
	Medium dense, black silty SAND, little gravel, damp (asphalt-based FILL/millings)															
		2.5	SS 1	11-10-8	18	67			4							
	Medium dense, brown silty SAND, little clay, damp (FILL)															
			SS 2	6-5-6	11	67										
	Hard, brown silty CLAY, trace sand and gravel, damp (CL)															
		5.0	SS 3	6-4-6	10	67		9000+ ^P								
	Bottom of borehole at 5.5 feet.															

GEOTECH STANDARD LOG - GINT STD US LAB.GDT -2/15/21 13:31 - C:\USERS\MSCHIEK\DESKTOP\ANNA0039.GPJ

LEGEND:	
▽ WATER LEVEL AT TIME OF DRILLING <u>N/A</u>	D = UCS TEST PERFORMED ON DISTURBED SAMPLE
▽ WATER LEVEL AT END OF DRILLING <u>N/A</u>	P = POCKET PENETROMETER TEST
▽ WATER LEVEL AFTER DRILLING <u>N/A</u>	T = TORVANE SHEAR TEST





The Mannik & Smith Group, Inc.
 2365 Haggerty Road South, Canton, MI 48188
 ph: (734) 397-3100 fax: (734) 397-3131
 www.manniksmithgroup.com

CLIENT <u>City of Ann Arbor</u>	PROJECT NAME <u>2021 Street Resurfacing</u>
PROJECT NUMBER <u>ANNA0039</u>	PROJECT LOCATION <u>Ann Arbor, MI</u>
DATE STARTED <u>2/1/21</u> COMPLETED <u>2/1/21</u>	BORING COORDINATES <u>N/A</u>
DRILLING METHOD <u>3.25" Direct Push Casing w/ 2" split spoon</u>	GROUND ELEVATION _____
DRILLING CONTRACTOR <u>MSG</u>	TOTAL DEPTH <u>5.5 FT</u> BACKFILL <u>Bentonite/soil cuttings/ashalt</u>
DRILL RIG <u>Geoprobe 7822DT</u> HAMMER TYPE <u>Automatic</u>	LOGGED BY <u>RG</u> CHECKED BY <u>ISS</u>
DRILLER <u>RJS</u>	REMARKS <u>2857 Verle Ave., 7 feet from curb</u>

GRAPHIC LOG	MATERIAL DESCRIPTION	DEPTH (FEET)	SAMPLE TYPE NUMBER	BLOW COUNTS	SPT N VALUE	RECOVERY % (RQD)	DRY DENSITY (PCF)	UNCONF. COMP. STRENGTH (PSF)	MOISTURE CONTENT (%)	▲ SPT N VALUE ▲				ATTERBERG LIMITS		
										10	20	30	40	PL	MC	LL
	ASPHALT (3 inches)	0.0														
	AGGREGATE BASE (4 inches)															
	Medium dense, brown gravelly SAND, trace silty, damp (FILL)															
		2.5	SS 1	9-8-8	16	67			7							
	Stiff to very stiff, brown silty CLAY, trace sand and gravel, damp (CL)															
			SS 2	5-6-7	13	67		6000 ^P								
	@4' stiff, brown mottled gray															
		5.0	SS 3	5-4-5	9	67		3500 ^P								
	Bottom of borehole at 5.5 feet.															

GEOTECH STANDARD LOG - GINT STD US LAB.GDT - 2/15/21 13:31 - C:\USERS\MSCHIEK\DESKTOP\ANNA0039.GPJ

LEGEND:

▽ WATER LEVEL AT TIME OF DRILLING <u>N/A</u>	D = UCS TEST PERFORMED ON DISTURBED SAMPLE
▽ WATER LEVEL AT END OF DRILLING <u>N/A</u>	P = POCKET PENETROMETER TEST
▽ WATER LEVEL AFTER DRILLING <u>N/A</u>	T = TORVANE SHEAR TEST



The Mannik & Smith Group, Inc.
 2365 Haggerty Road South, Canton, MI 48188
 ph: (734) 397-3100 fax: (734) 397-3131
 www.manniksmithgroup.com

CLIENT <u>City of Ann Arbor</u>	PROJECT NAME <u>2021 Street Resurfacing</u>
PROJECT NUMBER <u>ANNA0039</u>	PROJECT LOCATION <u>Ann Arbor, MI</u>
DATE STARTED <u>2/1/21</u> COMPLETED <u>2/1/21</u>	BORING COORDINATES <u>N/A</u>
DRILLING METHOD <u>3.25" Direct Push Casing w/ 2" split spoon</u>	GROUND ELEVATION _____
DRILLING CONTRACTOR <u>MSG</u>	TOTAL DEPTH <u>5.5 FT</u> BACKFILL <u>Bentonite/soil cuttings/ashalt</u>
DRILL RIG <u>Geoprobe 7822DT</u> HAMMER TYPE <u>Automatic</u>	LOGGED BY <u>RG</u> CHECKED BY <u>ISS</u>
DRILLER <u>RJS</u>	REMARKS <u>2921 Verle Ave., 6 feet from curb</u>

GRAPHIC LOG	MATERIAL DESCRIPTION	DEPTH (FEET)	SAMPLE TYPE NUMBER	BLOW COUNTS	SPT N VALUE	RECOVERY % (RQD)	DRY DENSITY (PCF)	UNCONF. COMP. STRENGTH (PSF)	MOISTURE CONTENT (%)	▲ SPT N VALUE ▲				ATTERBERG LIMITS		
										10	20	30	40	PL	MC	LL
0.0	ASPHALT (3 inches)															
0.5	AGGREGATE BASE (4 inches)															
	Medium dense, brown sandy GRAVEL, trace silt, dry (FILL)															
2.5	Stiff to very stiff, brown silty CLAY, trace sand and gravel, damp (FILL)		SS 1	8-6-6	12	67			6							
	Stiff, brown mottled gray silty CLAY, trace sand and gravel, damp (CL)		SS 2	8-5-6	11	67		5000 ^P								
5.0	Stiff, brown mottled gray silty CLAY, trace sand and gravel, damp (CL)		SS 3	5-6-6	12	67		3500 ^P								
	Bottom of borehole at 5.5 feet.															

GEOTECH STANDARD LOG - GINT STD US LAB.GDT - 2/15/21 13:31 - C:\USERS\MSCHIEK\DESKTOP\ANNA0039.GPJ

LEGEND:

▽ WATER LEVEL AT TIME OF DRILLING <u>N/A</u> ▽ WATER LEVEL AT END OF DRILLING <u>N/A</u> ▽ WATER LEVEL AFTER DRILLING <u>N/A</u>	D = UCS TEST PERFORMED ON DISTURBED SAMPLE P = POCKET PENETROMETER TEST T = TORVANE SHEAR TEST
--	--



The Mannik & Smith Group, Inc.
 2365 Haggerty Road South, Canton, MI 48188
 ph: (734) 397-3100 fax: (734) 397-3131
 www.manniksmithgroup.com

CLIENT <u>City of Ann Arbor</u>	PROJECT NAME <u>2021 Street Resurfacing</u>
PROJECT NUMBER <u>ANNA0039</u>	PROJECT LOCATION <u>Ann Arbor, MI</u>
DATE STARTED <u>2/2/21</u> COMPLETED <u>2/2/21</u>	BORING COORDINATES <u>N/A</u>
DRILLING METHOD <u>3.25" Direct Push Casing w/ 2" split spoon</u>	GROUND ELEVATION _____
DRILLING CONTRACTOR <u>MSG</u>	TOTAL DEPTH <u>5.5 FT</u> BACKFILL <u>Bentonite/soil cuttings/ashalt</u>
DRILL RIG <u>Geoprobe 7822DT</u> HAMMER TYPE <u>Automatic</u>	LOGGED BY <u>RG</u> CHECKED BY <u>ISS</u>
DRILLER <u>RJS</u>	REMARKS <u>2962 Verle Ave., 10 feet from curb</u>

GRAPHIC LOG	MATERIAL DESCRIPTION	DEPTH (FEET)	SAMPLE TYPE NUMBER	BLOW COUNTS	SPT N VALUE	RECOVERY % (RQD)	DRY DENSITY (PCF)	UNCONF. COMP. STRENGTH (PSF)	MOISTURE CONTENT (%)	▲ SPT N VALUE ▲				ATTERBERG LIMITS		
										10	20	30	40	PL	MC	LL
	ASPHALT (4 inches)	0.0														
	AGGREGATE BASE (4 inches)															
	Medium dense, black clayey SAND, trace gravel, moist (FILL)															
		2.5	SS 1	8-9-6	15	67			13							
	Stiff, brownish-gray silty CLAY, trace sand and gravel, damp (FILL)															
			SS 2	7-6-8	14	55		3000 ^P								
	Very stiff to hard, brown mottled gray silty CLAY, trace sand and gravel, damp (CL)															
		5.0	SS 3	8-9-8	17	55		9000+ ^P								
	Bottom of borehole at 5.5 feet.															

GEOTECH STANDARD LOG - GINT STD US LAB.GDT - 2/15/21 13:31 - C:\USERS\MSCHIEK\DESKTOP\ANNA0039.GPJ

LEGEND:	
▽ WATER LEVEL AT TIME OF DRILLING <u>N/A</u>	D = UCS TEST PERFORMED ON DISTURBED SAMPLE
▽ WATER LEVEL AT END OF DRILLING <u>N/A</u>	P = POCKET PENETROMETER TEST
▽ WATER LEVEL AFTER DRILLING <u>N/A</u>	T = TORVANE SHEAR TEST





The Mannik & Smith Group, Inc.
 2365 Haggerty Road South, Canton, MI 48188
 ph: (734) 397-3100 fax: (734) 397-3131
 www.manniksmithgroup.com

CLIENT <u>City of Ann Arbor</u>	PROJECT NAME <u>2021 Street Resurfacing</u>
PROJECT NUMBER <u>ANNA0039</u>	PROJECT LOCATION <u>Ann Arbor, MI</u>
DATE STARTED <u>2/2/21</u> COMPLETED <u>2/2/21</u>	BORING COORDINATES <u>N/A</u>
DRILLING METHOD <u>3.25" Direct Push Casing w/ 2" split spoon</u>	GROUND ELEVATION _____
DRILLING CONTRACTOR <u>MSG</u>	TOTAL DEPTH <u>5.5 FT</u> BACKFILL <u>Bentonite/soil cuttings/ashalt</u>
DRILL RIG <u>Geoprobe 7822DT</u> HAMMER TYPE <u>Automatic</u>	LOGGED BY <u>RG</u> CHECKED BY <u>ISS</u>
DRILLER <u>RJS</u>	REMARKS <u>2987 Verle Ave., 8 feet from curb</u>

GRAPHIC LOG	MATERIAL DESCRIPTION	DEPTH (FEET)	SAMPLE TYPE NUMBER	BLOW COUNTS	SPT N VALUE	RECOVERY % (RQD)	DRY DENSITY (PCF)	UNCONF. COMP. STRENGTH (PSF)	MOISTURE CONTENT (%)	▲ SPT N VALUE ▲				ATTERBERG LIMITS		
										10	20	30	40	PL	MC	LL
	ASPHALT (4 inches)	0.0														
	AGGREGATE BASE (4 inches)															
	Medium dense, brown to black clayey SAND, trace gravel, moist (FILL)															
		2.5	SS 1	10-8-6	14	67			13							
	Hard, dark gray sandy CLAY, trace gravel, damp (FILL)															
			SS 2	7-6-8	14	67		9000 ^P								
	Very stiff to hard, brown mottled gray silty CLAY, trace sand and gravel, damp (CL)															
		5.0	SS 3	10-8-9	17	67		9000 ^P								
	Bottom of borehole at 5.5 feet.															

GEOTECH STANDARD LOG - GINT STD US LAB.GDT - 2/15/21 13:31 - C:\USERS\MSCHIEK\DESKTOP\ANNA0039.GPJ

LEGEND:		
▽ WATER LEVEL AT TIME OF DRILLING <u>N/A</u>	D = UCS TEST PERFORMED ON DISTURBED SAMPLE	
▽ WATER LEVEL AT END OF DRILLING <u>N/A</u>	P = POCKET PENETROMETER TEST	
▽ WATER LEVEL AFTER DRILLING <u>N/A</u>	T = TORVANE SHEAR TEST	





The Mannik & Smith Group, Inc.
 2365 Haggerty Road South, Canton, MI 48188
 ph: (734) 397-3100 fax: (734) 397-3131
 www.manniksmithgroup.com

CLIENT <u>City of Ann Arbor</u>	PROJECT NAME <u>2021 Street Resurfacing</u>
PROJECT NUMBER <u>ANNA0039</u>	PROJECT LOCATION <u>Ann Arbor, MI</u>
DATE STARTED <u>2/2/21</u> COMPLETED <u>2/2/21</u>	BORING COORDINATES <u>N/A</u>
DRILLING METHOD <u>3.25" Direct Push Casing w/ 2" split spoon</u>	GROUND ELEVATION _____
DRILLING CONTRACTOR <u>MSG</u>	TOTAL DEPTH <u>5.5 FT</u> BACKFILL <u>Bentonite/soil cuttings/ashalt</u>
DRILL RIG <u>Geoprobe 7822DT</u> HAMMER TYPE <u>Automatic</u>	LOGGED BY <u>RG</u> CHECKED BY <u>ISS</u>
DRILLER <u>RJS</u>	REMARKS <u>2929 Brandywine Dr., 4 feet from curb</u>

GRAPHIC LOG	MATERIAL DESCRIPTION	DEPTH (FEET)	SAMPLE TYPE NUMBER	BLOW COUNTS	SPT N VALUE	RECOVERY % (RQD)	DRY DENSITY (PCF)	UNCONF. COMP. STRENGTH (PSF)	MOISTURE CONTENT (%)	▲ SPT N VALUE ▲				ATTERBERG LIMITS			
										10	20	30	40	PL	MC	LL	
	ASPHALT (4 inches)	0.0															
	AGGREGATE BASE (4 inches)																
	Loose, brown gravelly SAND, some silt, little clay, damp (FILL)																
		2.5	SS 1	10-5-4	9	67			7								
	Very stiff, gray silty CLAY, trace sand and gravel, damp (FILL)																
			SS 2	5-8-9	17	67		4000 ^P									
	Very stiff, brown mottled gray silty CLAY, trace sand, gravel, and organics, damp (CL)																
		5.0	SS 3	10-14-15	29	67		5000 ^P									
	Bottom of borehole at 5.5 feet.																

GEOTECH STANDARD LOG - GINT STD US LAB.GDT - 2/15/21 13:31 - C:\USERS\MSCHIEK\DESKTOP\ANNA0039.GPJ

LEGEND:
 ▽ WATER LEVEL AT TIME OF DRILLING N/A
 ▽ WATER LEVEL AT END OF DRILLING N/A
 ▽ WATER LEVEL AFTER DRILLING N/A

D = UCS TEST PERFORMED ON DISTURBED SAMPLE
 P = POCKET PENETROMETER TEST
 T = TORVANE SHEAR TEST



The Mannik & Smith Group, Inc.
 2365 Haggerty Road South, Canton, MI 48188
 ph: (734) 397-3100 fax: (734) 397-3131
 www.manniksmithgroup.com

CLIENT <u>City of Ann Arbor</u>	PROJECT NAME <u>2021 Street Resurfacing</u>
PROJECT NUMBER <u>ANNA0039</u>	PROJECT LOCATION <u>Ann Arbor, MI</u>
DATE STARTED <u>2/2/21</u> COMPLETED <u>2/2/21</u>	BORING COORDINATES <u>N/A</u>
DRILLING METHOD <u>3.25" Direct Push Casing w/ 2" split spoon</u>	GROUND ELEVATION _____
DRILLING CONTRACTOR <u>MSG</u>	TOTAL DEPTH <u>5.5 FT</u> BACKFILL <u>Bentonite/soil cuttings/ashalt</u>
DRILL RIG <u>Geoprobe 7822DT</u> HAMMER TYPE <u>Automatic</u>	LOGGED BY <u>RG</u> CHECKED BY <u>ISS</u>
DRILLER <u>RJS</u>	REMARKS <u>2909 Brandywine Dr., 5 feet from curb</u>

GRAPHIC LOG	MATERIAL DESCRIPTION	DEPTH (FEET)	SAMPLE TYPE NUMBER	BLOW COUNTS	SPT N VALUE	RECOVERY % (RQD)	DRY DENSITY (PCF)	UNCONF. COMP. STRENGTH (PSF)	MOISTURE CONTENT (%)	▲ SPT N VALUE ▲	ATTERBERG LIMITS			
										10 20 30 40	PL	MC	LL	
	ASPHALT (4 inches)	0.0												
	AGGREGATE BASE (4 inches)													
	Medium dense, brown silty SAND, little gravel, trace clay, moist (FILL)													
		2.5	SS 1	15-10-7	17	67			9					
	Stiff to very stiff, brown silty CLAY, little sand, trace gravel, damp (FILL)													
			SS 2	6-5-7	12	67		5000 ^P						
	@4' very stiff													
		5.0	SS 3	8-9-10	19	67		5000 ^P						
	Bottom of borehole at 5.5 feet.													

GEOTECH STANDARD LOG - GINT STD US LAB.GDT - 2/15/21 13:32 - C:\USERS\MSCHIEK\DESKTOP\ANNA0039.GPJ

LEGEND:
 ▽ WATER LEVEL AT TIME OF DRILLING N/A
 ▽ WATER LEVEL AT END OF DRILLING N/A
 ▽ WATER LEVEL AFTER DRILLING N/A

D = UCS TEST PERFORMED ON DISTURBED SAMPLE
 P = POCKET PENETROMETER TEST
 T = TORVANE SHEAR TEST



The Mannik & Smith Group, Inc.
 2365 Haggerty Road South, Canton, MI 48188
 ph: (734) 397-3100 fax: (734) 397-3131
 www.manniksmithgroup.com

CLIENT <u>City of Ann Arbor</u>	PROJECT NAME <u>2021 Street Resurfacing</u>
PROJECT NUMBER <u>ANNA0039</u>	PROJECT LOCATION <u>Ann Arbor, MI</u>
DATE STARTED <u>2/2/21</u> COMPLETED <u>2/2/21</u>	BORING COORDINATES <u>N/A</u>
DRILLING METHOD <u>3.25" Direct Push Casing w/ 2" split spoon</u>	GROUND ELEVATION _____
DRILLING CONTRACTOR <u>MSG</u>	TOTAL DEPTH <u>5.5 FT</u> BACKFILL <u>Bentonite/soil cuttings/ashalt</u>
DRILL RIG <u>Geoprobe 7822DT</u> HAMMER TYPE <u>Automatic</u>	LOGGED BY <u>RG</u> CHECKED BY <u>ISS</u>
DRILLER <u>RJS</u>	REMARKS <u>2808 Brandywine Dr., 6 feet from curb</u>

GRAPHIC LOG	MATERIAL DESCRIPTION	DEPTH (FEET)	SAMPLE TYPE NUMBER	BLOW COUNTS	SPT N VALUE	RECOVERY % (RQD)	DRY DENSITY (PCF)	UNCONF. COMP. STRENGTH (PSF)	MOISTURE CONTENT (%)	▲ SPT N VALUE ▲				ATTERBERG LIMITS		
										10	20	30	40	PL	MC	LL
	ASPHALT (4 inches)	0.0														
	AGGREGATE BASE (4 inches)															
	Medium dense, brown silty SAND, little gravel, trace clay, moist (FILL)															
		2.5	SS 1	15-10-9	19	55			10							
	Medium dense, brown silty SAND, damp (SM)															
			SS 2	8-8-8	16	55										
	Stiff to very stiff, brownish-gray silty CLAY, trace sand and gravel, da mp (CL)															
		5.0	SS 3	10-9-8	17	67		3000 ^P								
	Bottom of borehole at 5.5 feet.															

GEOTECH STANDARD LOG - GINT STD US LAB.GDT - 2/15/21 13:32 - C:\USERS\MSCHIEK\DESKTOP\ANNA0039.GPJ

LEGEND:	
▽ WATER LEVEL AT TIME OF DRILLING <u>N/A</u>	D = UCS TEST PERFORMED ON DISTURBED SAMPLE
▽ WATER LEVEL AT END OF DRILLING <u>N/A</u>	P = POCKET PENETROMETER TEST
▽ WATER LEVEL AFTER DRILLING <u>N/A</u>	T = TORVANE SHEAR TEST





The Mannik & Smith Group, Inc.
 2365 Haggerty Road South, Canton, MI 48188
 ph: (734) 397-3100 fax: (734) 397-3131
 www.manniksmithgroup.com

CLIENT <u>City of Ann Arbor</u>	PROJECT NAME <u>2021 Street Resurfacing</u>
PROJECT NUMBER <u>ANNA0039</u>	PROJECT LOCATION <u>Ann Arbor, MI</u>
DATE STARTED <u>2/2/21</u> COMPLETED <u>2/2/21</u>	BORING COORDINATES <u>N/A</u>
DRILLING METHOD <u>3.25" Direct Push Casing w/ 2" split spoon</u>	GROUND ELEVATION _____
DRILLING CONTRACTOR <u>MSG</u>	TOTAL DEPTH <u>5.5 FT</u> BACKFILL <u>Bentonite/soil cuttings/ashalt</u>
DRILL RIG <u>Geoprobe 7822DT</u> HAMMER TYPE <u>Automatic</u>	LOGGED BY <u>RG</u> CHECKED BY <u>ISS</u>
DRILLER <u>RJS</u>	REMARKS <u>Brandywine Dr., 6 feet from curb</u>

GRAPHIC LOG	MATERIAL DESCRIPTION	DEPTH (FEET)	SAMPLE TYPE NUMBER	BLOW COUNTS	SPT N VALUE	RECOVERY % (RQD)	DRY DENSITY (PCF)	UNCONF. COMP. STRENGTH (PSF)	MOISTURE CONTENT (%)	▲ SPT N VALUE ▲				ATTERBERG LIMITS		
										10	20	30	40	PL	MC	LL
	ASPHALT (4 inches)	0.0														
	AGGREGATE BASE (4 inches)															
	Medium dense, brown silty SAND, trace gravel, damp (FILL)															
	Very stiff, gray silty CLAY, trace sand and gravel, damp (FILL)	2.5	SS 1	9-9-8	17	67			13							
	Medium dense, brown clayey SILT, some sand, trace gravel, dry (FILL)		SS 2	6-9-9	18	67										
	Very stiff, grayish-brown sandy CLAY, trace gravel, moist (CL)	5.0	SS 3	10-11-18	29	67										
	Bottom of borehole at 5.5 feet.															

GEOTECH STANDARD LOG - GINT STD US LAB.GDT - 2/15/21 13:32 - C:\USERS\MSCHIEK\DESKTOP\ANNA0039.GPJ

LEGEND:
 ▽ WATER LEVEL AT TIME OF DRILLING N/A
 ▽ WATER LEVEL AT END OF DRILLING N/A
 ▽ WATER LEVEL AFTER DRILLING N/A

D = UCS TEST PERFORMED ON DISTURBED SAMPLE
 P = POCKET PENETROMETER TEST
 T = TORVANE SHEAR TEST



The Mannik & Smith Group, Inc.
 2365 Haggerty Road South, Canton, MI 48188
 ph: (734) 397-3100 fax: (734) 397-3131
 www.manniksmithgroup.com

CLIENT <u>City of Ann Arbor</u>	PROJECT NAME <u>2021 Street Resurfacing</u>
PROJECT NUMBER <u>ANNA0039</u>	PROJECT LOCATION <u>Ann Arbor, MI</u>
DATE STARTED <u>2/2/21</u> COMPLETED <u>2/2/21</u>	BORING COORDINATES <u>N/A</u>
DRILLING METHOD <u>3.25" Direct Push Casing w/ 2" split spoon</u>	GROUND ELEVATION _____
DRILLING CONTRACTOR <u>MSG</u>	TOTAL DEPTH <u>5.5 FT</u> BACKFILL <u>Bentonite/soil cuttings/ashalt</u>
DRILL RIG <u>Geoprobe 7822DT</u> HAMMER TYPE <u>Automatic</u>	LOGGED BY <u>RG</u> CHECKED BY <u>ISS</u>
DRILLER <u>RJS</u>	REMARKS <u>2706 Yost Blvd., 8 feet from curb</u>

GRAPHIC LOG	MATERIAL DESCRIPTION	DEPTH (FEET)	SAMPLE TYPE NUMBER	BLOW COUNTS	SPT N VALUE	RECOVERY % (RQD)	DRY DENSITY (PCF)	UNCONF. COMP. STRENGTH (PSF)	MOISTURE CONTENT (%)	▲ SPT N VALUE ▲				ATTERBERG LIMITS			
										10	20	30	40	PL	MC	LL	
	ASPHALT (4 inches)	0.0								◇ UNCONF. COMP. STRENGTH (PSF) ◇				□ DRY DENSITY (PCF) □			
	AGGREGATE BASE (4 inches)									2000 4000 6000 8000				100 110 120 130			
	Medium dense, brown to black silty SAND, little gravel, dry (FILL)																
		2.5	SS 1	10-8-8	16	67			2								
	Hard, dark brown to black sandy CLAY, trace gravel, damp (FILL)																
			SS 2	4-4-5	9	67		9000 ^P									
	@4' stiff																
		5.0	SS 3	5-7-8	15	67		2500 ^P									
	Bottom of borehole at 5.5 feet.																

GEOTECH STANDARD LOG - GINT STD US LAB.GDT - 2/15/21 13:32 - C:\USERS\MSCHIEK\DESKTOP\ANNA0039.GPJ

LEGEND:

▽ WATER LEVEL AT TIME OF DRILLING <u>N/A</u>	D = UCS TEST PERFORMED ON DISTURBED SAMPLE
▽ WATER LEVEL AT END OF DRILLING <u>N/A</u>	P = POCKET PENETROMETER TEST
▽ WATER LEVEL AFTER DRILLING <u>N/A</u>	T = TORVANE SHEAR TEST



The Mannik & Smith Group, Inc.
 2365 Haggerty Road South, Canton, MI 48188
 ph: (734) 397-3100 fax: (734) 397-3131
 www.manniksmithgroup.com

CLIENT <u>City of Ann Arbor</u>	PROJECT NAME <u>2021 Street Resurfacing</u>
PROJECT NUMBER <u>ANNA0039</u>	PROJECT LOCATION <u>Ann Arbor, MI</u>
DATE STARTED <u>2/2/21</u> COMPLETED <u>2/2/21</u>	BORING COORDINATES <u>N/A</u>
DRILLING METHOD <u>3.25" Direct Push Casing w/ 2" split spoon</u>	GROUND ELEVATION _____
DRILLING CONTRACTOR <u>MSG</u>	TOTAL DEPTH <u>5.5 FT</u> BACKFILL <u>Bentonite/soil cuttings/ashalt</u>
DRILL RIG <u>Geoprobe 7822DT</u> HAMMER TYPE <u>Automatic</u>	LOGGED BY <u>RG</u> CHECKED BY <u>ISS</u>
DRILLER <u>RJS</u>	REMARKS <u>2648 Yost Blvd, 8 feet from curb</u>

GRAPHIC LOG	MATERIAL DESCRIPTION	DEPTH (FEET)	SAMPLE TYPE NUMBER	BLOW COUNTS	SPT N VALUE	RECOVERY % (RQD)	DRY DENSITY (PCF)	UNCONF. COMP. STRENGTH (PSF)	MOISTURE CONTENT (%)	▲ SPT N VALUE ▲				ATTERBERG LIMITS		
										10	20	30	40	PL	MC	LL
	ASPHALT (3 inches)	0.0														
	AGGREGATE BASE (4 inches)															
	Medium dense, brown and black gravelly SAND, little silt, dry (FILL)															
		2.5	SS 1	10-8-6	14	67			6							
	Very stiff to hard, brown mottled gray silty CLAY, trace sand and gravel, damp (CL)															
		5.0	SS 2	9-8-9	17	67		9000 ^P								
			SS 3	7-8-7	15	67		9000 ^P								
	Bottom of borehole at 5.5 feet.															

GEOTECH STANDARD LOG - GINT STD US LAB.GDT - 2/15/21 13:32 - C:\USERS\MSCHIEK\DESKTOP\ANNA0039.GPJ

LEGEND:	
▽ WATER LEVEL AT TIME OF DRILLING <u>N/A</u>	D = UCS TEST PERFORMED ON DISTURBED SAMPLE
▽ WATER LEVEL AT END OF DRILLING <u>N/A</u>	P = POCKET PENETROMETER TEST
▽ WATER LEVEL AFTER DRILLING <u>N/A</u>	T = TORVANE SHEAR TEST





The Mannik & Smith Group, Inc.
 2365 Haggerty Road South, Canton, MI 48188
 ph: (734) 397-3100 fax: (734) 397-3131
 www.manniksmithgroup.com

CLIENT <u>City of Ann Arbor</u>	PROJECT NAME <u>2021 Street Resurfacing</u>
PROJECT NUMBER <u>ANNA0039</u>	PROJECT LOCATION <u>Ann Arbor, MI</u>
DATE STARTED <u>2/4/21</u> COMPLETED <u>2/4/21</u>	BORING COORDINATES <u>N/A</u>
DRILLING METHOD <u>3.25" Direct Push Casing w/ 2" split spoon</u>	GROUND ELEVATION _____
DRILLING CONTRACTOR <u>MSG</u>	TOTAL DEPTH <u>5.5 FT</u> BACKFILL <u>Bentonite/soil cuttings/ashalt</u>
DRILL RIG <u>Geoprobe 7822DT</u> HAMMER TYPE <u>Automatic</u>	LOGGED BY <u>RG</u> CHECKED BY <u>ISS</u>
DRILLER <u>RJS</u>	REMARKS <u>Yost Blvd., 5 feet from curb</u>

GRAPHIC LOG	MATERIAL DESCRIPTION	DEPTH (FEET)	SAMPLE TYPE NUMBER	BLOW COUNTS	SPT N VALUE	RECOVERY % (RQD)	DRY DENSITY (PCF)	UNCONF. COMP. STRENGTH (PSF)	MOISTURE CONTENT (%)	▲ SPT N VALUE ▲				ATTERBERG LIMITS		
										10	20	30	40	PL	MC	LL
0.0	ASPHALT (3 inches)															
0.5	AGGREGATE BASE (4 inches)															
1.0	Medium dense, brown silty SAND, little gravel, trace clay, damp (FILL)															
2.5	Stiff, dark gray silty CLAY, little sand, trace gravel, damp (FILL)		SS 1	10-6-6	12	55			5							
3.5			SS 2	5-7-7	14	55										
5.0	Hard, brown mottled gray silty CLAY, trace sand and gravel, damp (CL)		SS 3	8-8-6	14	67		9000+ ^P								
	Bottom of borehole at 5.5 feet.															

GEOTECH STANDARD LOG - GINT STD US LAB.GDT - 2/15/21 13:32 - C:\USERS\MSCHIEK\DESKTOP\ANNA0039.GPJ

LEGEND:

▽ WATER LEVEL AT TIME OF DRILLING <u>N/A</u>	D = UCS TEST PERFORMED ON DISTURBED SAMPLE
▽ WATER LEVEL AT END OF DRILLING <u>N/A</u>	P = POCKET PENETROMETER TEST
▽ WATER LEVEL AFTER DRILLING <u>N/A</u>	T = TORVANE SHEAR TEST



The Mannik & Smith Group, Inc.
 2365 Haggerty Road South, Canton, MI 48188
 ph: (734) 397-3100 fax: (734) 397-3131
 www.manniksmithgroup.com

CLIENT <u>City of Ann Arbor</u>	PROJECT NAME <u>2021 Street Resurfacing</u>
PROJECT NUMBER <u>ANNA0039</u>	PROJECT LOCATION <u>Ann Arbor, MI</u>
DATE STARTED <u>2/4/21</u> COMPLETED <u>2/4/21</u>	BORING COORDINATES <u>N/A</u>
DRILLING METHOD <u>3.25" Direct Push Casing w/ 2" split spoon</u>	GROUND ELEVATION _____
DRILLING CONTRACTOR <u>MSG</u>	TOTAL DEPTH <u>5.5 FT</u> BACKFILL <u>Bentonite/soil cuttings/ashalt</u>
DRILL RIG <u>Geoprobe 7822DT</u> HAMMER TYPE <u>Automatic</u>	LOGGED BY <u>RG</u> CHECKED BY <u>ISS</u>
DRILLER <u>RJS</u>	REMARKS <u>2409 Yost Blvd., 7 feet from curb</u>

GRAPHIC LOG	MATERIAL DESCRIPTION	DEPTH (FEET)	SAMPLE TYPE NUMBER	BLOW COUNTS	SPT N VALUE	RECOVERY % (RQD)	DRY DENSITY (PCF)	UNCONF. COMP. STRENGTH (PSF)	MOISTURE CONTENT (%)	▲ SPT N VALUE ▲				ATTERBERG LIMITS		
										10	20	30	40	PL	MC	LL
0.0	ASPHALT (3 inches)															
0.5	AGGREGATE BASE (4 inches)															
1.5	Medium dense, black silty SAND, little gravel and clay, trace asphalt fragments, damp (FILL)															
2.5	Stiff, gray sandy CLAY, some gravel, damp (FILL)		SS 1	10-7-4	11	67			7							
3.5																
4.5	Stiff, brown mottled gray silty CLAY, trace sand and gravel, moist (CL)		SS 2	6-7-8	15	67		2000 ^P								
5.0																
5.5	Stiff, brown mottled gray silty CLAY, trace sand and gravel, moist (CL)		SS 3	9-8-6	14	67		2000 ^P								
	Bottom of borehole at 5.5 feet.															

GEOTECH STANDARD LOG - GINT STD US LAB.GDT - 2/15/21 13:32 - C:\USERS\MSCHIEK\DESKTOP\ANNA0039.GPJ

LEGEND:

▽ WATER LEVEL AT TIME OF DRILLING <u>N/A</u> ▽ WATER LEVEL AT END OF DRILLING <u>N/A</u> ▽ WATER LEVEL AFTER DRILLING <u>N/A</u>	D = UCS TEST PERFORMED ON DISTURBED SAMPLE P = POCKET PENETROMETER TEST T = TORVANE SHEAR TEST
--	--



The Mannik & Smith Group, Inc.
 2365 Haggerty Road South, Canton, MI 48188
 ph: (734) 397-3100 fax: (734) 397-3131
 www.manniksmithgroup.com

CLIENT <u>City of Ann Arbor</u>	PROJECT NAME <u>2021 Street Resurfacing</u>
PROJECT NUMBER <u>ANNA0039</u>	PROJECT LOCATION <u>Ann Arbor, MI</u>
DATE STARTED <u>2/4/21</u> COMPLETED <u>2/4/21</u>	BORING COORDINATES <u>N/A</u>
DRILLING METHOD <u>3.25" Direct Push Casing w/ 2" split spoon</u>	GROUND ELEVATION _____
DRILLING CONTRACTOR <u>MSG</u>	TOTAL DEPTH <u>5.5 FT</u> BACKFILL <u>Bentonite/soil cuttings/ashalt</u>
DRILL RIG <u>Geoprobe 7822DT</u> HAMMER TYPE <u>Automatic</u>	LOGGED BY <u>RG</u> CHECKED BY <u>ISS</u>
DRILLER <u>RJS</u>	REMARKS <u>2310 Yost Blvd., 6 feet from curb</u>

GRAPHIC LOG	MATERIAL DESCRIPTION	DEPTH (FEET)	SAMPLE TYPE NUMBER	BLOW COUNTS	SPT N VALUE	RECOVERY % (RQD)	DRY DENSITY (PCF)	UNCONF. COMP. STRENGTH (PSF)	MOISTURE CONTENT (%)	▲ SPT N VALUE ▲				ATTERBERG LIMITS		
										10	20	30	40	PL	MC	LL
	ASPHALT (4 inches)	0.0														
	AGGREGATE BASE (4 inches)															
	Medium dense, black silty SAND, trace gravel, damp (FILL)															
		2.5	SS 1	9-8-6	14	67			9							
	Stiff to very stiff, brown silty CLAY, trace sand and gravel, damp (CL)															
	@4' hard		SS 2	6-7-8	15	67		6000 ^P								
		5.0	SS 3	7-6-6	12	67		8500 ^P								
	Bottom of borehole at 5.5 feet.															

GEOTECH STANDARD LOG - GINT STD US LAB.GDT - 2/15/21 13:32 - C:\USERS\MSCHIEK\DESKTOP\ANNA0039.GPJ

LEGEND:	
▽ WATER LEVEL AT TIME OF DRILLING <u>N/A</u>	D = UCS TEST PERFORMED ON DISTURBED SAMPLE
▽ WATER LEVEL AT END OF DRILLING <u>N/A</u>	P = POCKET PENETROMETER TEST
▽ WATER LEVEL AFTER DRILLING <u>N/A</u>	T = TORVANE SHEAR TEST





The Mannik & Smith Group, Inc.
 2365 Haggerty Road South, Canton, MI 48188
 ph: (734) 397-3100 fax: (734) 397-3131
 www.manniksmithgroup.com

CLIENT <u>City of Ann Arbor</u>	PROJECT NAME <u>2021 Street Resurfacing</u>
PROJECT NUMBER <u>ANNA0039</u>	PROJECT LOCATION <u>Ann Arbor, MI</u>
DATE STARTED <u>1/27/21</u> COMPLETED <u>1/27/21</u>	BORING COORDINATES <u>N/A</u>
DRILLING METHOD <u>3.25" Direct Push Casing w/ 2" split spoon</u>	GROUND ELEVATION _____
DRILLING CONTRACTOR <u>MSG</u>	TOTAL DEPTH <u>5.5 FT</u> BACKFILL <u>Bentonite/soil cuttings/ashalt</u>
DRILL RIG <u>Geoprobe 7822DT</u> HAMMER TYPE <u>Automatic</u>	LOGGED BY <u>RG</u> CHECKED BY <u>ISS</u>
DRILLER <u>RJS</u>	REMARKS <u>2375 Crestland St., 6 feet from curb</u>

GRAPHIC LOG	MATERIAL DESCRIPTION	DEPTH (FEET)	SAMPLE TYPE NUMBER	BLOW COUNTS	SPT N VALUE	RECOVERY % (RQD)	DRY DENSITY (PCF)	UNCONF. COMP. STRENGTH (PSF)	MOISTURE CONTENT (%)	▲ SPT N VALUE ▲				ATTERBERG LIMITS		
										10	20	30	40	PL	MC	LL
	ASPHALT (4 inches)	0.0														
	AGGREGATE BASE (4 inches)															
	Medium stiff, brown gravelly SAND, little silt, damp (FILL)															
		2.5	SS 1	10-6-5	11	67			4							
	Very stiff to hard, brown silty CLAY, trace sand and gravel, damp (FILL)															
			SS 2	5-8-8	16	67		9000 ^P								
	Very stiff, brown silty CLAY, trace sand and gravel, damp (CL)															
		5.0	SS 3	10-10-10	20	67		4500 ^P								
	Bottom of borehole at 5.5 feet.															

GEOTECH STANDARD LOG - GINT STD US LAB.GDT - 2/15/21 13:33 - C:\USERS\MSCHIEK\DESKTOP\ANNA0039.GPJ

LEGEND:

WATER LEVEL AT TIME OF DRILLING N/A
 WATER LEVEL AT END OF DRILLING N/A
 WATER LEVEL AFTER DRILLING N/A

D = UCS TEST PERFORMED ON DISTURBED SAMPLE
 P = POCKET PENETROMETER TEST
 T = TORVANE SHEAR TEST



The Mannik & Smith Group, Inc.
 2365 Haggerty Road South, Canton, MI 48188
 ph: (734) 397-3100 fax: (734) 397-3131
 www.manniksmithgroup.com

CLIENT <u>City of Ann Arbor</u>	PROJECT NAME <u>2021 Street Resurfacing</u>
PROJECT NUMBER <u>ANNA0039</u>	PROJECT LOCATION <u>Ann Arbor, MI</u>
DATE STARTED <u>2/8/21</u> COMPLETED <u>2/8/21</u>	BORING COORDINATES <u>N/A</u>
DRILLING METHOD <u>3.25" Direct Push Casing w/ 2" split spoon</u>	GROUND ELEVATION _____
DRILLING CONTRACTOR <u>MSG</u>	TOTAL DEPTH <u>5.5 FT</u> BACKFILL <u>Bentonite/soil cuttings/ashalt</u>
DRILL RIG <u>Geoprobe 7822DT</u> HAMMER TYPE <u>Automatic</u>	LOGGED BY <u>RG</u> CHECKED BY <u>ISS</u>
DRILLER <u>RJS</u>	REMARKS <u>Crestland St., 6 feet from curb</u>

GRAPHIC LOG	MATERIAL DESCRIPTION	DEPTH (FEET)	SAMPLE TYPE NUMBER	BLOW COUNTS	SPT N VALUE	RECOVERY % (RQD)	DRY DENSITY (PCF)	UNCONF. COMP. STRENGTH (PSF)	MOISTURE CONTENT (%)	▲ SPT N VALUE ▲				ATTERBERG LIMITS			
										10	20	30	40	PL	MC	LL	
	ASPHALT (4 inches)	0.0															
	AGGREGATE BASE (4 inches)																
	Medium dense, brown gravelly SAND, some silt, trace clay, damp (FILL)																
		2.5	SS 1	15-9-6	15	67			5								
	Very stiff to hard, brown silty CLAY, trace sand and gravel, damp (CL)																
		5.0	SS 2	8-9-10	19	67		9000+ ^P									
			SS 3	12-14-15	29	67		9000+ ^P									
	Bottom of borehole at 5.5 feet.																

GEOTECH STANDARD LOG - GINT STD US LAB.GDT - 2/15/21 13:33 - C:\USERS\MSCHEIKEN\DESKTOP\ANNA0039.GPJ

LEGEND:		
▽ WATER LEVEL AT TIME OF DRILLING <u>N/A</u>	D = UCS TEST PERFORMED ON DISTURBED SAMPLE	
▽ WATER LEVEL AT END OF DRILLING <u>N/A</u>	P = POCKET PENETROMETER TEST	
▽ WATER LEVEL AFTER DRILLING <u>N/A</u>	T = TORVANE SHEAR TEST	





The Mannik & Smith Group, Inc.
 2365 Haggerty Road South, Canton, MI 48188
 ph: (734) 397-3100 fax: (734) 397-3131
 www.manniksmithgroup.com

CLIENT <u>City of Ann Arbor</u>	PROJECT NAME <u>2021 Street Resurfacing</u>
PROJECT NUMBER <u>ANNA0039</u>	PROJECT LOCATION <u>Ann Arbor, MI</u>
DATE STARTED <u>2/4/21</u> COMPLETED <u>2/4/21</u>	BORING COORDINATES <u>N/A</u>
DRILLING METHOD <u>3.25" Direct Push Casing w/ 2" split spoon</u>	GROUND ELEVATION _____
DRILLING CONTRACTOR <u>MSG</u>	TOTAL DEPTH <u>5.5 FT</u> BACKFILL <u>Bentonite/soil cuttings/ashalt</u>
DRILL RIG <u>Geoprobe 7822DT</u> HAMMER TYPE <u>Automatic</u>	LOGGED BY <u>RG</u> CHECKED BY <u>ISS</u>
DRILLER <u>RJS</u>	REMARKS <u>2580 Packard, bick path</u>

GRAPHIC LOG	MATERIAL DESCRIPTION	DEPTH (FEET)	SAMPLE TYPE NUMBER	BLOW COUNTS	SPT N VALUE	RECOVERY % (RQD)	DRY DENSITY (PCF)	UNCONF. COMP. STRENGTH (PSF)	MOISTURE CONTENT (%)	▲ SPT N VALUE ▲				ATTERBERG LIMITS		
										10	20	30	40	PL	MC	LL
	ASPHALT (3 inches)	0.0														
	AGGREGATE BASE (4 inches)															
	Medium stiff, gray sandy CLAY, trace gravel and organics, damp (FILL)															
	@2.5' dark brown	2.5	SS 1	2-3-3	6	55			22							
	@4' medium stiff to stiff		SS 2	2-3-2	5	55		1000 ^P								
		5.0	SS 3	2-3-3	6	67		3000 ^P								
	Bottom of borehole at 5.5 feet.															

GEOTECH STANDARD LOG - GINT STD US LAB.GDT - 2/15/21 13:33 - C:\USERS\MSCHIEK\DESKTOP\ANNA0039.GPJ

LEGEND:	
▽ WATER LEVEL AT TIME OF DRILLING <u>N/A</u>	D = UCS TEST PERFORMED ON DISTURBED SAMPLE
▽ WATER LEVEL AT END OF DRILLING <u>N/A</u>	P = POCKET PENETROMETER TEST
▽ WATER LEVEL AFTER DRILLING <u>N/A</u>	T = TORVANE SHEAR TEST





The Mannik & Smith Group, Inc.
 2365 Haggerty Road South, Canton, MI 48188
 ph: (734) 397-3100 fax: (734) 397-3131
 www.manniksmithgroup.com

CLIENT <u>City of Ann Arbor</u>	PROJECT NAME <u>2021 Street Resurfacing</u>
PROJECT NUMBER <u>ANNA0039</u>	PROJECT LOCATION <u>Ann Arbor, MI</u>
DATE STARTED <u>2/4/21</u> COMPLETED <u>2/4/21</u>	BORING COORDINATES <u>N/A</u>
DRILLING METHOD <u>3.25" Direct Push Casing w/ 2" split spoon</u>	GROUND ELEVATION _____
DRILLING CONTRACTOR <u>MSG</u>	TOTAL DEPTH <u>5.5 FT</u> BACKFILL <u>Bentonite/soil cuttings/ashalt</u>
DRILL RIG <u>Geoprobe 7822DT</u> HAMMER TYPE <u>Automatic</u>	LOGGED BY <u>RG</u> CHECKED BY <u>ISS</u>
DRILLER <u>RJS</u>	REMARKS <u>2580 Packard, bick path</u>

GRAPHIC LOG	MATERIAL DESCRIPTION	DEPTH (FEET)	SAMPLE TYPE NUMBER	BLOW COUNTS	SPT N VALUE	RECOVERY % (RQD)	DRY DENSITY (PCF)	UNCONF. COMP. STRENGTH (PSF)	MOISTURE CONTENT (%)	▲ SPT N VALUE ▲				ATTERBERG LIMITS			
										10	20	30	40	PL	MC	LL	
	ASPHALT (4 inches)	0.0															
	AGGREGATE BASE (4 inches)																
	Soft to medium stiff, brown sandy CLAY, trace gravel, moist (CL)																
		2.5	SS 1	3-2-2	4	67		1500 ^P	16								
			SS 2	3-3-4	7	55		500 ^P									
	Very stiff, brown silty CLAY, trace sand and gravel, damp (CL)																
		5.0	SS 3	2-3-4	7	67		6500 ^P									
	Bottom of borehole at 5.5 feet.																

GEOTECH STANDARD LOG - GINT STD US LAB.GDT - 2/15/21 13:33 - C:\USERS\MSCHIEK\DESKTOP\ANNA0039.GPJ

LEGEND:	
▽ WATER LEVEL AT TIME OF DRILLING <u>N/A</u>	D = UCS TEST PERFORMED ON DISTURBED SAMPLE
▽ WATER LEVEL AT END OF DRILLING <u>N/A</u>	P = POCKET PENETROMETER TEST
▽ WATER LEVEL AFTER DRILLING <u>N/A</u>	T = TORVANE SHEAR TEST





The Mannik & Smith Group, Inc.
 2365 Haggerty Road South, Canton, MI 48188
 ph: (734) 397-3100 fax: (734) 397-3131
 www.manniksmithgroup.com

CLIENT <u>City of Ann Arbor</u>	PROJECT NAME <u>2021 Street Resurfacing</u>
PROJECT NUMBER <u>ANNA0039</u>	PROJECT LOCATION <u>Ann Arbor, MI</u>
DATE STARTED <u>2/4/21</u> COMPLETED <u>2/4/21</u>	BORING COORDINATES <u>N/A</u>
DRILLING METHOD <u>3.25" Direct Push Casing w/ 2" split spoon</u>	GROUND ELEVATION _____
DRILLING CONTRACTOR <u>MSG</u>	TOTAL DEPTH <u>5.5 FT</u> BACKFILL <u>Bentonite/soil cuttings/ashalt</u>
DRILL RIG <u>Geoprobe 7822DT</u> HAMMER TYPE <u>Automatic</u>	LOGGED BY <u>RG</u> CHECKED BY <u>ISS</u>
DRILLER <u>RJS</u>	REMARKS <u>2580 Packard, bick path</u>

GRAPHIC LOG	MATERIAL DESCRIPTION	DEPTH (FEET)	SAMPLE TYPE NUMBER	BLOW COUNTS	SPT N VALUE	RECOVERY % (RQD)	DRY DENSITY (PCF)	UNCONF. COMP. STRENGTH (PSF)	MOISTURE CONTENT (%)	▲ SPT N VALUE ▲				ATTERBERG LIMITS		
										10	20	30	40	PL	MC	LL
	ASPHALT (4 inches)	0.0														
	AGGREGATE BASE (4 inches)															
	▽ Stiff, brown sandy CLAY, trace gravel, wet (FILL)															
		2.5	SS 1	4-5-4	9	67			19							
			SS 2	5-5-4	9	67										
	@4' soft, dark brown to black (possibly organic)															
		5.0	SS 3	3-5-6	11	67		500 ^P								
	Bottom of borehole at 5.5 feet.															

GEOTECH STANDARD LOG - GINT STD US LAB.GDT - 2/15/21 13:33 - C:\USERS\MSCHIEK\DESKTOP\ANNA0039.GPJ

LEGEND:

▽ WATER LEVEL AT TIME OF DRILLING <u>1 FEET</u>	D = UCS TEST PERFORMED ON DISTURBED SAMPLE
▽ WATER LEVEL AT END OF DRILLING <u>N/A</u>	P = POCKET PENETROMETER TEST
▽ WATER LEVEL AFTER DRILLING <u>N/A</u>	T = TORVANE SHEAR TEST



The Mannik & Smith Group, Inc.
 2365 Haggerty Road South, Canton, MI 48188
 ph: (734) 397-3100 fax: (734) 397-3131
 www.manniksmithgroup.com

CLIENT <u>City of Ann Arbor</u>	PROJECT NAME <u>2021 Street Resurfacing</u>
PROJECT NUMBER <u>ANNA0039</u>	PROJECT LOCATION <u>Ann Arbor, MI</u>
DATE STARTED <u>2/4/21</u> COMPLETED <u>2/4/21</u>	BORING COORDINATES <u>N/A</u>
DRILLING METHOD <u>3.25" Direct Push Casing w/ 2" split spoon</u>	GROUND ELEVATION _____
DRILLING CONTRACTOR <u>MSG</u>	TOTAL DEPTH <u>5.5 FT</u> BACKFILL <u>Bentonite/soil cuttings/ashalt</u>
DRILL RIG <u>Geoprobe 7822DT</u> HAMMER TYPE <u>Automatic</u>	LOGGED BY <u>RG</u> CHECKED BY <u>ISS</u>
DRILLER <u>RJS</u>	REMARKS <u>2580 Packard, bick path</u>

GRAPHIC LOG	MATERIAL DESCRIPTION	DEPTH (FEET)	SAMPLE TYPE NUMBER	BLOW COUNTS	SPT N VALUE	RECOVERY % (RQD)	DRY DENSITY (PCF)	UNCONF. COMP. STRENGTH (PSF)	MOISTURE CONTENT (%)	▲ SPT N VALUE ▲				ATTERBERG LIMITS		
										10	20	30	40	PL	MC	LL
	ASPHALT (4 inches)	0.0														
	AGGREGATE BASE (4 inches)															
	∇ Medium dense, brown clayey SAND, little gravel, wet (SC)															
	@2.5' trace gravel, dry	2.5	SS 1	4-5-6	11	67			21							
			SS 2	6-5-6	11	67										
	Hard, brown silty CLAY, trace sand and gravel, damp (CL)	5.0	SS 3	4-5-6	11	67		9000+ ^P								
	Bottom of borehole at 5.5 feet.															

GEOTECH STANDARD LOG - GINT STD US LAB.GDT - 2/15/21 13:33 - C:\USERS\MSCHIEK\DESKTOP\ANNA0039.GPJ

LEGEND:	
∇ WATER LEVEL AT TIME OF DRILLING <u>1 FEET</u>	D = UCS TEST PERFORMED ON DISTURBED SAMPLE
∇ WATER LEVEL AT END OF DRILLING <u>N/A</u>	P = POCKET PENETROMETER TEST
∇ WATER LEVEL AFTER DRILLING <u>N/A</u>	T = TORVANE SHEAR TEST





The Mannik & Smith Group, Inc.
 2365 Haggerty Road South, Canton, MI 48188
 ph: (734) 397-3100 fax: (734) 397-3131
 www.manniksmithgroup.com

CLIENT <u>City of Ann Arbor</u>	PROJECT NAME <u>2021 Street Resurfacing</u>
PROJECT NUMBER <u>ANNA0039</u>	PROJECT LOCATION <u>Ann Arbor, MI</u>
DATE STARTED <u>2/5/21</u> COMPLETED <u>2/5/21</u>	BORING COORDINATES <u>N/A</u>
DRILLING METHOD <u>3.25" Direct Push Casing w/ 2" split spoon</u>	GROUND ELEVATION _____
DRILLING CONTRACTOR <u>MSG</u>	TOTAL DEPTH <u>5.5 FT</u> BACKFILL <u>Bentonite/soil cuttings/ashalt</u>
DRILL RIG <u>Geoprobe 7822DT</u> HAMMER TYPE <u>Automatic</u>	LOGGED BY <u>RG</u> CHECKED BY <u>ISS</u>
DRILLER <u>RJS</u>	REMARKS <u>2715 Packard St., on sidewalk</u>

GRAPHIC LOG	MATERIAL DESCRIPTION	DEPTH (FEET)	SAMPLE TYPE NUMBER	BLOW COUNTS	SPT N VALUE	RECOVERY % (RQD)	DRY DENSITY (PCF)	UNCONF. COMP. STRENGTH (PSF)	MOISTURE CONTENT (%)	▲ SPT N VALUE ▲				ATTERBERG LIMITS		
										10	20	30	40	PL	MC	LL
	ASPHALT (3 inches)	0.0														
	AGGREGATE BASE (4 inches)															
	Stiff, dark brown sandy CLAY, trace gravel and organics, wet (FILL)															
	SS 1			8-7-8	15	67			23							
	Medium dense, brown clayey SAND, damp (FILL)	2.5														
	SS 2			6-8-9	17	67										
	Medium dense, brown silty SAND, trace gravel and clay, damp (FILL)															
	SS 3	5.0		6-8-6	14	67										
	Bottom of borehole at 5.5 feet.															

GEOTECH STANDARD LOG - GINT STD US LAB.GDT - 2/15/21 13:33 - C:\USERS\MSCHIEK\DESKTOP\ANNA0039.GPJ

LEGEND:	
▽ WATER LEVEL AT TIME OF DRILLING <u>1 FEET</u>	D = UCS TEST PERFORMED ON DISTURBED SAMPLE
▽ WATER LEVEL AT END OF DRILLING <u>N/A</u>	P = POCKET PENETROMETER TEST
▽ WATER LEVEL AFTER DRILLING <u>N/A</u>	T = TORVANE SHEAR TEST





The Mannik & Smith Group, Inc.
 2365 Haggerty Road South, Canton, MI 48188
 ph: (734) 397-3100 fax: (734) 397-3131
 www.manniksmithgroup.com

CLIENT <u>City of Ann Arbor</u>	PROJECT NAME <u>2021 Street Resurfacing</u>
PROJECT NUMBER <u>ANNA0039</u>	PROJECT LOCATION <u>Ann Arbor, MI</u>
DATE STARTED <u>2/5/21</u> COMPLETED <u>2/5/21</u>	BORING COORDINATES <u>N/A</u>
DRILLING METHOD <u>3.25" Direct Push Casing w/ 2" split spoon</u>	GROUND ELEVATION _____
DRILLING CONTRACTOR <u>MSG</u>	TOTAL DEPTH <u>5.5 FT</u> BACKFILL <u>Bentonite/soil cuttings/ashalt</u>
DRILL RIG <u>Geoprobe 7822DT</u> HAMMER TYPE <u>Automatic</u>	LOGGED BY <u>RG</u> CHECKED BY <u>ISS</u>
DRILLER <u>RJS</u>	REMARKS <u>Buhr Park, Packard St., on sidewalk</u>

GRAPHIC LOG	MATERIAL DESCRIPTION	DEPTH (FEET)	SAMPLE TYPE NUMBER	BLOW COUNTS	SPT N VALUE	RECOVERY % (RQD)	DRY DENSITY (PCF)	UNCONF. COMP. STRENGTH (PSF)	MOISTURE CONTENT (%)	▲ SPT N VALUE ▲				ATTERBERG LIMITS			
										10	20	30	40	PL	MC	LL	
	ASPHALT (4 inches)	0.0															
	AGGREGATE BASE (4 inches)																
	Medium stiff, dark brown sandy CLAY, trace organics, damp (FILL)																
	@2.5' very stiff	2.5	SS 1	8-8-5	13	67		1000 ^P	16	◇	▲						
			SS 2	7-8-9	17	67					▲						
	Medium dense, brown clayey SAND, trace gravel, damp (FILL)																
		5.0	SS 3	10-8-9	17	67					▲						
	Bottom of borehole at 5.5 feet.																

GEOTECH STANDARD LOG - GINT STD US LAB.GDT - 2/15/21 13:33 - C:\USERS\MSCHEIKEN\DESKTOP\ANNA0039.GPJ

LEGEND:	▽ WATER LEVEL AT TIME OF DRILLING <u>N/A</u>	D = UCS TEST PERFORMED ON DISTURBED SAMPLE
▽ WATER LEVEL AT END OF DRILLING <u>N/A</u>	▽ WATER LEVEL AFTER DRILLING <u>N/A</u>	P = POCKET PENETROMETER TEST
		T = TORVANE SHEAR TEST





The Mannik & Smith Group, Inc.
 2365 Haggerty Road South, Canton, MI 48188
 ph: (734) 397-3100 fax: (734) 397-3131
 www.manniksmithgroup.com

CLIENT <u>City of Ann Arbor</u>	PROJECT NAME <u>2021 Street Resurfacing</u>
PROJECT NUMBER <u>ANNA0039</u>	PROJECT LOCATION <u>Ann Arbor, MI</u>
DATE STARTED <u>2/5/21</u> COMPLETED <u>2/5/21</u>	BORING COORDINATES <u>N/A</u>
DRILLING METHOD <u>3.25" Direct Push Casing w/ 2" split spoon</u>	GROUND ELEVATION _____
DRILLING CONTRACTOR <u>MSG</u>	TOTAL DEPTH <u>5.5 FT</u> BACKFILL <u>Bentonite/soil cuttings/ashalt</u>
DRILL RIG <u>Geoprobe 7822DT</u> HAMMER TYPE <u>Automatic</u>	LOGGED BY <u>RG</u> CHECKED BY <u>ISS</u>
DRILLER <u>RJS</u>	REMARKS <u>2898 Packard St., on sidewalk</u>

GRAPHIC LOG	MATERIAL DESCRIPTION	DEPTH (FEET)	SAMPLE TYPE NUMBER	BLOW COUNTS	SPT N VALUE	RECOVERY % (RQD)	DRY DENSITY (PCF)	UNCONF. COMP. STRENGTH (PSF)	MOISTURE CONTENT (%)	▲ SPT N VALUE ▲				ATTERBERG LIMITS		
										10	20	30	40	PL	MC	LL
	ASPHALT (4 inches)	0.0														
	AGGREGATE BASE (4 inches)															
	Medium stiff to stiff, brown silty CLAY, trace sand and gravel, damp (FILL)															
		2.5	SS 1	9-8-6	14	67		1500 ^P	24	◇						
	Hard, brown silty CLAY, little sand, damp (CL)															
			SS 2	9-9-6	15	67		9000+ ^P								
		5.0	SS 3	7-8-9	17	67		9000+ ^P								
	Bottom of borehole at 5.5 feet.															

GEOTECH STANDARD LOG - GINT STD US LAB.GDT - 2/15/21 13:33 - C:\USERS\MSCHIEK\DESKTOP\ANNA0039.GPJ

LEGEND:		
▽ WATER LEVEL AT TIME OF DRILLING <u>N/A</u>	D = UCS TEST PERFORMED ON DISTURBED SAMPLE	
▽ WATER LEVEL AT END OF DRILLING <u>N/A</u>	P = POCKET PENETROMETER TEST	
▽ WATER LEVEL AFTER DRILLING <u>N/A</u>	T = TORVANE SHEAR TEST	





The Mannik & Smith Group, Inc.
 2365 Haggerty Road South, Canton, MI 48188
 ph: (734) 397-3100 fax: (734) 397-3131
 www.manniksmithgroup.com

CLIENT <u>City of Ann Arbor</u>	PROJECT NAME <u>2021 Street Resurfacing</u>
PROJECT NUMBER <u>ANNA0039</u>	PROJECT LOCATION <u>Ann Arbor, MI</u>
DATE STARTED <u>2/5/21</u> COMPLETED <u>2/5/21</u>	BORING COORDINATES <u>N/A</u>
DRILLING METHOD <u>3.25" Direct Push Casing w/ 2" split spoon</u>	GROUND ELEVATION _____
DRILLING CONTRACTOR <u>MSG</u>	TOTAL DEPTH <u>5.5 FT</u> BACKFILL <u>Bentonite/soil cuttings/ashalt</u>
DRILL RIG <u>Geoprobe 7822DT</u> HAMMER TYPE <u>Automatic</u>	LOGGED BY <u>RG</u> CHECKED BY <u>ISS</u>
DRILLER <u>RJS</u>	REMARKS <u>3012 Packard St., on sidewalk</u>

GRAPHIC LOG	MATERIAL DESCRIPTION	DEPTH (FEET)	SAMPLE TYPE NUMBER	BLOW COUNTS	SPT N VALUE	RECOVERY % (RQD)	DRY DENSITY (PCF)	UNCONF. COMP. STRENGTH (PSF)	MOISTURE CONTENT (%)	▲ SPT N VALUE ▲				ATTERBERG LIMITS		
										10	20	30	40	PL	MC	LL
	ASPHALT (4 inches)	0.0														
	AGGREGATE BASE (4 inches)															
	Dark brown, sandy TOPSOIL, damp (FILL)															
		2.5	SS 1	6-5-4	9	67			24							
	Stiff, brown silty CLAY, trace sand and gravel, damp (CL)															
	@4' hard, brown mottled gray		SS 2	5-4-4	8	67		4000 ^P								
		5.0	SS 3	5-5-5	10	67		9000+ ^P								
	Bottom of borehole at 5.5 feet.															

GEOTECH STANDARD LOG - GINT STD US LAB.GDT - 2/15/21 13:33 - C:\USERS\MSCHIEK\DESKTOP\ANNA0039.GPJ

LEGEND:	
▽ WATER LEVEL AT TIME OF DRILLING <u>N/A</u>	D = UCS TEST PERFORMED ON DISTURBED SAMPLE
▽ WATER LEVEL AT END OF DRILLING <u>N/A</u>	P = POCKET PENETROMETER TEST
▽ WATER LEVEL AFTER DRILLING <u>N/A</u>	T = TORVANE SHEAR TEST





The Mannik & Smith Group, Inc.
 2365 Haggerty Road South, Canton, MI 48188
 ph: (734) 397-3100 fax: (734) 397-3131
 www.manniksmithgroup.com

CLIENT <u>City of Ann Arbor</u>	PROJECT NAME <u>2021 Street Resurfacing</u>
PROJECT NUMBER <u>ANNA0039</u>	PROJECT LOCATION <u>Ann Arbor, MI</u>
DATE STARTED <u>2/5/21</u> COMPLETED <u>2/5/21</u>	BORING COORDINATES <u>N/A</u>
DRILLING METHOD <u>3.25" Direct Push Casing w/ 2" split spoon</u>	GROUND ELEVATION _____
DRILLING CONTRACTOR <u>MSG</u>	TOTAL DEPTH <u>5.5 FT</u> BACKFILL <u>Bentonite/soil cuttings/ashalt</u>
DRILL RIG <u>Geoprobe 7822DT</u> HAMMER TYPE <u>Automatic</u>	LOGGED BY <u>RG</u> CHECKED BY <u>ISS</u>
DRILLER <u>RJS</u>	REMARKS <u>1975 Huron Parkway</u>

GRAPHIC LOG	MATERIAL DESCRIPTION	DEPTH (FEET)	SAMPLE TYPE NUMBER	BLOW COUNTS	SPT N VALUE	RECOVERY % (RQD)	DRY DENSITY (PCF)	UNCONF. COMP. STRENGTH (PSF)	MOISTURE CONTENT (%)	▲ SPT N VALUE ▲				ATTERBERG LIMITS			
										10	20	30	40	PL	MC	LL	
	ASPHALT (4 inches)	0.0															
	AGGREGATE BASE (4 inches)																
	Stiff to very stiff, brown to dark brown silty CLAY, some sand, trace gravel and organics, damp (FILL)		SS 1	6-8-8	16	55		3000 ^P	16								
	Dark brown PEAT/TOPSOIL, wet	2.5	SS 2	5-4-3	7	67											
	Very stiff, brown mottled gray silty CLAY, trace sand and gravel, damp (CL)		SS 3	5-5-3	8	67		6500 ^P									
	Bottom of borehole at 5.5 feet.	5.0															

GEOTECH STANDARD LOG - GINT STD US LAB.GDT - 2/15/21 13:33 - C:\USERS\MSCHIE\DESKTOP\ANNA0039.GPJ

LEGEND:		
▽ WATER LEVEL AT TIME OF DRILLING <u>2.5 FEET</u>	D = UCS TEST PERFORMED ON DISTURBED SAMPLE	
▽ WATER LEVEL AT END OF DRILLING <u>N/A</u>	P = POCKET PENETROMETER TEST	
▽ WATER LEVEL AFTER DRILLING <u>N/A</u>	T = TORVANE SHEAR TEST	





The Mannik & Smith Group, Inc.
 2365 Haggerty Road South, Canton, MI 48188
 ph: (734) 397-3100 fax: (734) 397-3131
 www.manniksmithgroup.com

CLIENT <u>City of Ann Arbor</u>	PROJECT NAME <u>2021 Street Resurfacing</u>
PROJECT NUMBER <u>ANNA0039</u>	PROJECT LOCATION <u>Ann Arbor, MI</u>
DATE STARTED <u>1/29/21</u> COMPLETED <u>1/29/21</u>	BORING COORDINATES <u>N/A</u>
DRILLING METHOD <u>3.25" Direct Push Casing w/ 2" split spoon</u>	GROUND ELEVATION _____
DRILLING CONTRACTOR <u>MSG</u>	TOTAL DEPTH <u>5.5 FT</u> BACKFILL <u>Bentonite/soil cuttings/ashalt</u>
DRILL RIG <u>Geoprobe 7822DT</u> HAMMER TYPE <u>Automatic</u>	LOGGED BY <u>RG</u> CHECKED BY <u>ISS</u>
DRILLER <u>RJS</u>	REMARKS <u>2203 Independence Blvd., 4 feet from curb</u>

GRAPHIC LOG	MATERIAL DESCRIPTION	DEPTH (FEET)	SAMPLE TYPE NUMBER	BLOW COUNTS	SPT N VALUE	RECOVERY % (RQD)	DRY DENSITY (PCF)	UNCONF. COMP. STRENGTH (PSF)	MOISTURE CONTENT (%)	▲ SPT N VALUE ▲				ATTERBERG LIMITS		
										10	20	30	40	PL	MC	LL
	ASPHALT (4 inches)	0.0														
	AGGREGATE BASE (4 inches)															
	Loose, brown clayey SAND, little gravel, moist (FILL)															
		2.5	SS 1	10-6-3	9	55			9							
	Stiff, brown mottled gray sandy CLAY, trace gravel, damp (CL)															
	@4' very stiff to hard															
		5.0	SS 2	3-6-9	15	55		3500 ^P								
			SS 3	13-15-15	30	67		7000 ^P								
	Bottom of borehole at 5.5 feet.															

GEOTECH STANDARD LOG - GINT STD US LAB.GDT - 2/15/21 13:33 - C:\USERS\MSCHIEK\DESKTOP\ANNA0039.GPJ

LEGEND:

WATER LEVEL AT TIME OF DRILLING N/A
D = UCS TEST PERFORMED ON DISTURBED SAMPLE
 WATER LEVEL AT END OF DRILLING N/A
P = POCKET PENETROMETER TEST
 WATER LEVEL AFTER DRILLING N/A
T = TORVANE SHEAR TEST



The Mannik & Smith Group, Inc.
 2365 Haggerty Road South, Canton, MI 48188
 ph: (734) 397-3100 fax: (734) 397-3131
 www.manniksmithgroup.com

CLIENT <u>City of Ann Arbor</u>	PROJECT NAME <u>2021 Street Resurfacing</u>
PROJECT NUMBER <u>ANNA0039</u>	PROJECT LOCATION <u>Ann Arbor, MI</u>
DATE STARTED <u>1/29/21</u> COMPLETED <u>1/29/21</u>	BORING COORDINATES <u>N/A</u>
DRILLING METHOD <u>3.25" Direct Push Casing w/ 2" split spoon</u>	GROUND ELEVATION _____
DRILLING CONTRACTOR <u>MSG</u>	TOTAL DEPTH <u>5.5 FT</u> BACKFILL <u>Bentonite/soil cuttings/ashalt</u>
DRILL RIG <u>Geoprobe 7822DT</u> HAMMER TYPE <u>Automatic</u>	LOGGED BY <u>RG</u> CHECKED BY <u>ISS</u>
DRILLER <u>RJS</u>	REMARKS <u>2249 Independence Blvd., 6 feet from curb</u>

GRAPHIC LOG	MATERIAL DESCRIPTION	DEPTH (FEET)	SAMPLE TYPE NUMBER	BLOW COUNTS	SPT N VALUE	RECOVERY % (RQD)	DRY DENSITY (PCF)	UNCONF. COMP. STRENGTH (PSF)	MOISTURE CONTENT (%)	▲ SPT N VALUE ▲				ATTERBERG LIMITS		
										10	20	30	40	PL	MC	LL
	ASPHALT (4 inches)	0.0														
	AGGREGATE BASE (4 inches)															
	Medium dense, brown gravelly SAND, some silt, little clay, damp (FILL)															
		2.5	SS 1	10-6-6	12	67			10							
	Stiff, gray silty CLAY, little sand, trace gravel, moist (sand seams present) (CL)															
	@4' stiff to very stiff		SS 2	7-8-8	16	67		2000 ^P								
		5.0	SS 3	10-10-8	18	67		3500 ^P								
	Bottom of borehole at 5.5 feet.															

GEOTECH STANDARD LOG - GINT STD US LAB.GDT - 2/15/21 13:33 - C:\USERS\MSCHIEK\DESKTOP\ANNA0039.GPJ

LEGEND:		
▽ WATER LEVEL AT TIME OF DRILLING <u>N/A</u>		D = UCS TEST PERFORMED ON DISTURBED SAMPLE
▽ WATER LEVEL AT END OF DRILLING <u>N/A</u>		P = POCKET PENETROMETER TEST
▽ WATER LEVEL AFTER DRILLING <u>N/A</u>		T = TORVANE SHEAR TEST



CARP0004-005 06/01/2018

LIVINGSTON (Townships of Brighton, Deerfield, Genoa, Hartland, Oceola & Tyrone), MACOMB, MONROE, OAKLAND, SANILAC, ST. CLAIR AND WAYNE COUNTIES

	Rates	Fringes
CARPENTER (Piledriver).....	\$ 30.50	27.28

ELEC0017-005 06/01/2020

STATEWIDE

	Rates	Fringes
Line Construction		
Groundman/Driver.....	\$ 28.84	16.03
Journeyman Signal Tech, Communications Tech, Tower Tech & Fiber Optic Splicers.	\$ 41.44	20.00
Journeyman Specialist.....	\$ 47.66	21.96
Operator A.....	\$ 35.02	17.99
Operator B.....	\$ 32.69	17.25

Classifications

Journeyman Specialist: Refers to a crew of only one person working alone.

Operator A: Shall be proficient in operating all power equipment including: Backhoe, Excavator, Directional Bore and Boom/Digger truck.

Operator B: Shall be proficient in operating any 2 of the above mentioned pieces of equipment listed under Operator A.

ENGI0324-003 06/01/2020

ALCONA, ALPENA, ARENAC, BAY, CHEBOYGAN, CLARE, CLINTON, CRAWFORD, GENESEE, GLADWIN, GRATIOT, HURON, INGHAM, IOSCO, ISABELLA, JACKSON, LAPEER, LENAWEE, LIVINGSTON, MACOMB, MIDLAND, MONROE, MONTMORENCY, OAKLAND, OGEMAW, OSCODA, OTSEGO, PRESQUE ISLE, ROSCOMMON, SAGINAW, ST. CLAIR, SANILAC, SHIAWASSEE, TUSCOLA, WASHTENAW AND WAYNE COUNTIES:

Rates	Fringes
-------	---------

OPERATOR: Power Equipment
(Steel Erection)

GROUP 1.....	\$ 47.02	24.85
GROUP 2.....	\$ 48.02	24.85
GROUP 3.....	\$ 45.52	24.85
GROUP 4.....	\$ 46.52	24.85
GROUP 5.....	\$ 44.02	24.85
GROUP 6.....	\$ 45.02	24.85
GROUP 7.....	\$ 43.75	24.85
GROUP 8.....	\$ 44.75	24.85
GROUP 9.....	\$ 43.30	24.85
GROUP 10.....	\$ 44.30	24.85
GROUP 11.....	\$ 42.57	24.85
GROUP 12.....	\$ 43.57	24.85
GROUP 13.....	\$ 42.21	24.85
GROUP 14.....	\$ 43.21	24.85
GROUP 15.....	\$ 41.57	24.85
GROUP 16.....	\$ 38.62	24.85
GROUP 17.....	\$ 24.14	12.00
GROUP 18.....	\$ 27.63	12.00

FOOTNOTE:

Paid Holidays: New Year's Day, Memorial Day, Fourth of July, Labor Day, Thanksgiving Day and Christmas Day.

POWER EQUIPMENT OPERATOR CLASSIFICATIONS

GROUP 1: Engineer when operating combination of boom and jib 400' or longer

GROUP 2: Engineer when operating combination of boom and jib 400' or longer on a crane that requires an oiler

GROUP 3: Engineer when operating combination of boom and jib 300' or longer

GROUP 4: Engineer when operating combination of boom and jib 300' or longer on a crane that requires an oiler

GROUP 5: Engineer when operating combination of boom and jib 220' or longer

GROUP 6: Engineer when operating combination of boom and jib 220' or longer on a crane that requires an oiler

GROUP 7: Engineer when operating combination of boom and jib 140' or longer

GROUP 8: Engineer when operating combination of boom and jib 140' or longer on a crane that requires an oiler

GROUP 9: Tower crane & derrick operator (where operator's work station is 50 ft. or more above first sub-level)

GROUP 10: Tower crane & derrick operator (where operator's work station is 50 ft. or more above first sub-level) on a crane that requires an oiler

GROUP 11: Engineer when operating combination of boom and jib 120' or longer

GROUP 12: Engineer when operating combination of boom and jib 120' or longer on a crane that requires an oiler

GROUP 13: Crane operator; job mechanic and 3 drum hoist and excavator

GROUP 14: Crane operator on a crane that requires an oiler

GROUP 15: Hoisting operator; 2 drum hoist and rubber tired backhoe

GROUP 16: Forklift and 1 drum hoist

GROUP 17: Compressor or welder operator

GROUP 18: Oiler

ENGI0324-004 06/01/2020

AREA 1: ALLEGAN, BARRY, BERRIEN, BRANCH, CALHOUN, CASS, EATON, HILLSDALE, IONIA, KALAMAZOO, KENT, LAKE, MANISTEE, MASON, MECOSTA, MONTCALM, MUSKEGON, NEWAYGO, OCEANA, OSCEOLA, OTTAWA, ST. JOSEPH, VAN BUREN

AREA 2: ANTRIM, BENZIE, CHARLEVOIX, EMMET, GRAND TRAVERSE, KALKASKA, LEELANAU, MISSAUKEE AND WEXFORD COUNTIES:

Rates Fringes

OPERATOR: Power Equipment
(Steel Erection)

	Rates	Fringes
AREA 1		
GROUP 1.....	\$ 47.02	24.85
GROUP 2.....	\$ 43.75	24.85
GROUP 3.....	\$ 42.21	24.85

GROUP 4.....	\$ 38.62	24.85
GROUP 5.....	\$ 24.14	12.00
GROUP 6.....	\$ 27.63	12.00
AREA 2		
GROUP 1.....	\$ 47.02	24.85
GROUP 2.....	\$ 43.75	24.85
GROUP 3.....	\$ 42.21	24.85
GROUP 4.....	\$ 38.62	24.85
GROUP 5.....	\$ 24.14	12.00
GROUP 6.....	\$ 27.63	12.00

FOOTNOTES:

Crane operator with main boom and jib 300' or longer: \$1.50 additional to the group 1 rate. Crane operator with main boom and jib 400' or longer: \$3.00 additional to the group 1 rate.

PAID HOLIDAYS: New Year's Day, Memorial Day, Fourth of July, Labor Day, Thanksgiving Day and Christmas Day.

POWER EQUIPMENT OPERATOR CLASSIFICATIONS:

GROUP 1: Crane Operator with main boom & jib 400', 300', or 220' or longer.

GROUP 2: Crane Operator with main boom & jib 140' or longer, Tower Crane; Gantry Crane; Whirley Derrick.

GROUP 3: Regular Equipment Operator, Crane, Dozer, Loader, Hoist, Straddle Wagon, Mechanic, Grader and Hydro Excavator.

GROUP 4: Air Tugger (single drum), Material Hoist Pump 6" or over, Elevators, Brokk Concrete Breaker.

GROUP 5: Air Compressor, Welder, Generators, Conveyors

GROUP 6: Oiler and fire tender

ENGI0324-005 09/01/2020

AREA 1: GENESEE, LAPEER, LIVINGSTON, MACOMB, MONROE, OAKLAND, ST. CLAIR, WASHTENAW AND WAYNE COUNTIES

AREA 2: ALCONA, ALLEGAN, ALGER, ALPENA, ANTRIM, ARENAC, BARAGA, BARRY, BAY, BENZIE, BERRIEN, BRANCH, CALHOUN, CASS, CHARLEVOIX, CHEBOYGAN, CHIPPEWA, CLARE, CLINTON, CRAWFORD, DELTA, DICKINSON, EATON, EMMET, GLADWIN, GOGEBIC, GRAND TRAVERSE, GRATIOT, HILLSDALE, HOUGHTON, HURON, INGHAM, IONIA, IOSCO, IRON, ISABELLA, JACKSON, KALAMAZOO, KALKASKA, KENT,

KWEENAW, LAKE, LEELANAU, LENAWEE, LUCE, MACKINAC, MANISTEE, MARQUETTE, MASON, MECOSTA, MENOMINEE, MIDLAND, MISSAUKEE, MONTCALM, MONTMORENCY, MUSKEGON, NEWAYGO, OCEANA, OGEMAW, ONTONAGON, OSCEOLA, OSCODA, OTSEGO, OTTAWA, PRESQUE ISLE, ROSCOMMON, SAGINAW, SANILAC, SCHOOLCRAFT, SHIAWASSEE, ST. JOSEPH, TUSCOLA, VAN BUREN AND WEXFORD COUNTIES

	Rates	Fringes
OPERATOR: Power Equipment (Underground construction (including sewer))		
AREA 1:		
GROUP 1.....	\$ 35.88	24.85
GROUP 2.....	\$ 31.15	24.85
GROUP 3.....	\$ 30.42	24.85
GROUP 4.....	\$ 29.85	24.85
GROUP 5.....	\$ 21.40	12.05
AREA 2:		
GROUP 1.....	\$ 34.17	24.85
GROUP 2.....	\$ 29.28	24.85
GROUP 3.....	\$ 28.78	24.85
GROUP 4.....	\$ 28.50	24.85
GROUP 5.....	\$ 21.40	12.05

POWER EQUIPMENT OPERATOR CLASSIFICATIONS

GROUP 1: Backfiller tamper; Backhoe; Batch plant operator (concrete); Clamshell; Concrete paver (2 drums or larger); Conveyor loader (Euclid type); Crane (crawler, truck type or pile driving); Dozer; Dragline; Elevating grader; Endloader; Gradall (and similar type machine); Grader; Mechanic; Power shovel; Roller (asphalt); Scraper (self-propelled or tractor drawn); Side boom tractor (type D-4 or equivalent and larger); Slip form paver; Slope paver; Trencher (over 8 ft. digging capacity); Well drilling rig; Concrete pump with boom operator; Hydro Excavator

GROUP 2: Boom truck (power swing type boom); Crusher; Hoist; Pump (1 or more - 6-in. discharge or larger - gas or diesel- powered or powered by generator of 300 amperes or more - inclusive of generator); Side boom tractor (smaller than type D-4 or equivalent); Tractor (pneu-tired, other than backhoe or front end loader); Trencher (8-ft. digging capacity and smaller); Vac Truck and End dump operator;

GROUP 3: Air compressors (600 cfm or larger); Air compressors (2 or more-less than 600 cfm); Boom truck (non-swinging,

non- powered type boom); Concrete breaker (self-propelled or truck mounted - includes compressor); Concrete paver (1 drum-1/2 yd. or larger); Elevator (other than passenger); Maintenance person; Pump (2 or more-4-in. up to 6-in. discharge-gas or diesel powered - excluding submersible pumps); Pumpcrete machine (and similar equipment); Wagon drill (multiple); Welding machine or generator (2 or more-300 amp. or larger - gas or diesel powered)

GROUP 4: Boiler; Concrete saw (40 hp or over); Curing machine (self-propelled); Farm tractor (with attachment); Finishing machine (concrete); Hydraulic pipe pushing machine; Mulching equipment; Pumps (2 or more up to 4-in. discharge, if used 3 hours or more a day, gas or diesel powered - excluding submersible pumps); Roller (other than asphalt); Stump remover; Trencher (service); Vibrating compaction equipment, self-propelled (6 ft. wide or over); Sweeper (Wayne type); Water wagon and Extend-a boom forklift

Group 5: Fire Person, Oiler

 * ENGI0324-006 06/01/2020

GENESEE, MACOMB, MONROE, OAKLAND, WASHTENAW, WAYNE, ALCONA, ALGER, ALLEGAN, ALPENA, ANTRIM, ARENAC, BARAGA, BARRY, BAY, BENZIE, BERRIEN, BRANCH, CALHOUN, CASS, CHARLEVOIX, CHEBOYGAN, CHIPPEWA, CLARE, CLINTON, CRAWFORD, DELTA, DICKINSON, EATON, EMMET, GLADWIN, GOGEBIC, GRAND TRAVERSE, GRATIOT, HILLSDALE, HOUGHTON, HURON, INGHAM, IONIA, IOSCO, IRON, ISABELLA, JACKSON, KALAMAZOO, KALKASKA, KENT, KEWEENAW, LAKE, LAPEER, LEELANAU, LENAWEE, LIVINGSTON, LUCE, MACKINAC, MANISTEE, MARQUETTE, MASON, MECOSTA, MENOMINEE, MIDLAND, MISSAUKEE, MONTCALM, MONTMORENCY, MUSKEGON, NEWAYGO, OCEANA, OGEMAW, ONTONAGON, OSCEOLA, OSCODA, OTSEGO, OTTAWA, PRESQUE ISLE, ROSCOMMON, SAGINAW, ST. CLARE, ST. JOSEPH, SANILAC, SCHOOLCRAFT, SHIAWASSEE, TUSCOLA, VAN BUREN AND WEXFORD COUNTIES

	Rates	Fringes
Power equipment operators: (AIRPORT, BRIDGE & HIGHWAY CONSTRUCTION)		
GROUP 1.....	\$ 34.91	24.85
GROUP 2.....	\$ 28.18	24.85
GROUP 3.....	\$ 27.62	24.85
GROUP 4.....	\$ 27.45	24.85

POWER EQUIPMENT OPERATOR CLASSIFICATIONS

GROUP 1: Asphalt plant operator; Crane operator (does not include work on bridge construction projects when the crane operator is erecting structural components); Dragline operator; Shovel operator; Locomotive operator; Paver operator (5 bags or more); Elevating grader operator; Pile driving operator; Roller operator (asphalt); Blade grader operator; Trenching machine operator (ladder or wheel type); Auto-grader; Slip form paver; Self-propelled or tractor-drawn scraper; Conveyor loader operator (Euclid type); Endloader operator (1 yd. capacity and over); Bulldozer; Hoisting engineer; Tractor operator; Finishing machine operator (asphalt); Mechanic; Pump operator (6-in. discharge or over, gas, diesel powered or generator of 300 amp. or larger); Shouldering or gravel distributing machine operator (self-propelled); Backhoe (with over 3/8 yd. bucket); Side boom tractor (type D-4 or equivalent or larger); Tube finisher (slip form paving); Gradall (and similar type machine); Asphalt paver (self-propelled); Asphalt planer (self-propelled); Batch plant (concrete-central mix); Slurry machine (asphalt); Concrete pump (3 in. and over); Roto-mill; Swinging boom truck (over 12 ton capacity); Hydro demolisher (water blaster); Farm-type tractor with attached pan; Vacuum truck operator; Batch Plant (concrete dry batch); Concrete Saw Operator (40h.p. or over; Tractor Operator (farm type); Finishing Machine Operator (concrete); Grader Operator (self-propelled fine grade or form (concrete)).

GROUP 2: Screening plant operator; Washing plant operator; Crusher operator; Backhoe (with 3/8 yd. bucket or less); Side boom tractor (smaller than D-4 type or equivalent); Sweeper (Wayne type and similar equipment); Grease Truck; Air Compressor Operator (600 cu.ft. per min or more); Air Compressor Operator (two or more, less than 600 cfm);

GROUP 3: Boiler fire tender; Tractor operator (farm type with attachment); Concrete Breaker; Wagon Drill Operator;

GROUP 4: Oiler; Fire tender; Trencher (service); Flexplane operator; Cleftplane operator; Boom or winch hoist truck operator; Endloader operator (*under 1 yd. capacity); Roller Operator (other than asphalt); Curing equipment operator (self-propelled); Power bin operator; Plant drier (6 ft. wide or over); Guard post driver operator (power driven); All mulching equipment; Stump remover; Concrete pump (under 3-in.); Mesh installer (self-propelled); End dump; Skid Steer.

ENGI0324-007 05/01/2020

ALGER, BARAGA, CHIPPEWA, DELTA, DICKINSON, GOGEBIC, HOUGHTON, IRON, KEWEENAW, LUCE, MACKINAC MARQUETTE, MENOMINEE, ONTONAGON AND SCHOOLCRAFT COUNTIES:

	Rates	Fringes
OPERATOR: Power Equipment (Steel Erection)		
Compressor, welder and forklift.....	\$ 33.90	24.60
Crane operator, main boom & jib 120' or longer.....	\$ 40.37	24.60
Crane operator, main boom & jib 140' or longer.....	\$ 40.67	24.60
Crane operator, main boom & jib 220' or longer.....	\$ 41.26	24.60
Mechanic with truck and tools.....	\$ 39.50	24.60
Oiler and fireman.....	\$ 32.36	24.60
Regular operator.....	\$ 37.72	24.60

ENGI0324-008 10/01/2015

ALCONA, ALGER, ALLEGAN, ALPENA, ANTRIM, ARENAC, BARAGA, BARRY, BAY, BENZIE, BERRIEN, BRANCH, CALHOUN, CASS, CHARLEVOIX, CHEBOYGAN, CHIPPEWA, CLARE, CLINTON, CRAWFORD, DELTA, DICKINSON, EATON, EMMET, GENESEE, GLADWIN, GOGEBIC, GRAND TRAVERSE, GRATIOT, HILLSDALE, HOUGHTON, HURON, INGHAM, IONIA, IOSCO, IRON, ISABELLA, JACKSON, KALAMAZOO, KALKASKA, KENT, KEWEENAW, LAKE, LAPEER, LEELANAU, LENAWEE, LIVINGSTON, LUCE, MACKINAC, MACOMB, MANISTEE, MARQUETTE, MASON, MECOSTA, MENOMINEE, MIDLAND, MISSAUKEE, MONTCALM, MONTMORENCY, MONROE, MUSKEGON, NEWAYGO, OAKLAND, OCEANA, OGEMAW, ONTONAGON, OSCEOLA, OSCODA, OTSEGO, OTTAWA, PRESQUE ISLE, ROSCOMMON, SAGINAW, ST. CLARE, ST. JOSEPH, SANILAC, SCHOOLCRAFT, SHIAWASSEE, TUSCOLA, VAN BUREN, WASHTENAW, WAYNE AND WEXFORD COUNTIES

	Rates	Fringes
OPERATOR: Power Equipment (Sewer Relining)		
GROUP 1.....	\$ 30.70	12.93
GROUP 2.....	\$ 29.17	12.93

SEWER RELINING CLASSIFICATIONS

GROUP 1: Operation of audio-visual closed circuit TV system, including remote in-ground cutter and other equipment used in connection with the CCTV system

GROUP 2: Operation of hot water heaters and circulation systems, water jetters and vacuum and mechanical debris removal systems

ENGI0325-012 05/01/2020

	Rates	Fringes
Power equipment operators - gas distribution and duct installation work:		
GROUP 1.....	\$ 32.18	24.85
GROUP 2.....	\$ 32.06	24.85
GROUP 3.....	\$ 30.35	24.85

SCOPE OF WORK: The construction, installation, treating and reconditioning of pipelines transporting gas vapors within cities, towns, subdivisions, suburban areas, or within private property boundaries, up to and including private meter settings of private industrial, governmental or other premises, more commonly referred to as "distribution work," starting from the first metering station, connection, similar or related facility, of the main or cross country pipeline and including duct installation.

Group 1: Backhoe, crane, grader, mechanic, dozer (D-6 equivalent or larger), side boom (D-4 equivalent or larger), trencher(except service), endloader (2 yd. capacity or greater).

GROUP 2: Dozer (less than D-6 equivalent), endloader (under 2 yd. capacity), side boom (under D-4 capacity), backfiller, pumps (1 or 2 of 6-inch discharge or greater), boom truck (with powered boom), tractor (wheel type other than backhoe or front endloader). Tamper (self-propelled), boom truck (with non-powered boom), concrete saw (20 hp or larger), pumps (2 to 4 under 6-inch discharge), compressor (2 or more or when one is used continuously into the second day) and trencher(service).

GROUP 3: Oiler, hydraulic pipe pushing machine, grease person and hydrostatic testing operator.

IRON0008-007 06/01/2020

ALGER, BARAGA, CHIPPEWA, DELTA, DICKINSON, GOGEBIC, HOUGHTON,
 IRON, KEWEENAW, LUCE, MACKINAC MARQUETTE, MENOMINEE, ONTONAGON
 AND SCHOOLCRAFT COUNTIES:

	Rates	Fringes
Ironworker - pre-engineered metal building erector.....	\$ 23.70	6.95
IRONWORKER		
General contracts \$10,000,000 or greater.....	\$ 34.99	27.12
General contracts less than \$10,000,000.....	\$ 34.99	27.12

Paid Holidays: New Year's Day, Memorial Day, July 4th, Labor
 Day, Thanksgiving Day & Christmas Day.

 IRON0025-002 06/01/2019

ALCONA, ALPENA, ARENAC, BAY, CHEBOYGAN, CLARE, CLINTON,
 CRAWFORD, GENESEE, GLADWIN, GRATIOT, HURON, INGHAM, IOSCO,
 ISABELLA, JACKSON, LAPEER, LIVINGSTON, MACOMB, MIDLAND,
 MONTMORENCY, OAKLAND, OGEMAW, OSCODA, OTSEGO, PRESQUE ISLE,
 ROSCOMMON, SAGINAW, SANILAC, SHIAWASSEE, ST. CLAIR, TUSCOLA,
 WASHTENAW AND WAYNE COUNTIES:

	Rates	Fringes
Ironworker - pre-engineered metal building erector Alcona, Alpena, Arenac, Cheboygan, Clare, Clinton, Crawford, Gladwin, Gratiot, Huron, Ingham, Iosco, Isabella, Jackson, Lapeer, Livingston (west of Burkhardt Road), Montmorency, Ogemaw, Oscoda, Otsego, Presque Isle, Roscommon, Sanilac, Shiawassee, Tuscola & Washtenaw (west of U.S. 23).	\$ 24.26	22.11
Bay, Genesee, Lapeer, Livingston (east of Burkhardt Road), Macomb, Midland, Oakland, Saginaw,		

St. Clair, The University of Michigan, Washtenaw (east of U.S. 23) & Wayne...	\$ 25.48	23.11
IRONWORKER		
Ornamental and Structural...	\$ 36.77	29.03
Reinforcing.....	\$ 30.98	27.99

IRON0055-005 07/01/2020

LENAWEE AND MONROE COUNTIES:

	Rates	Fringes
IRONWORKER		
Pre-engineered metal buildings.....	\$ 23.59	19.35
All other work.....	\$ 31.00	25.60

IRON0292-003 06/01/2020

BERRIEN AND CASS COUNTIES:

	Rates	Fringes
IRONWORKER (Including pre-engineered metal building erecator).....	\$ 31.75	22.84

IRON0340-001 06/19/2017

ALLEGAN, ANTRIM, BARRY, BENZIE, BRANCH, CALHOUN, CHARLEVOIX,
EATON, EMMET, GRAND TRAVERSE, HILLSDALE, IONIA, KALAMAZOO,
KALKASKA, KENT, LAKE, LEELANAU, MANISTEE, MASON, MECOSTA,
MISSAUKEE, MONTCALM, MUSKEGON, NEWAYGO, OCEANA, OSCEOLA,
OTTAWA, ST. JOSEPH, VAN BUREN AND WEXFORD COUNTIES:

	Rates	Fringes
IRONWORKER (Including pre-engineered metal building erecator).....	\$ 24.43	24.67

LAB00005-006 10/01/2020

	Rates	Fringes
Laborers - hazardous waste abatement: (ALCONA, ALPENA, ANTRIM, BENZIE, CHARLEVOIX,		

CHEBOYGAN, CRAWFORD, EMMET,
 GRAND TRAVERSE, IOSCO,
 KALKASKA, LEELANAU,
 MISSAUKEE, MONTMORENCY,
 OSCODA, OTSEGO, PRESQUE ISLE
 AND WEXFORD COUNTIES - Zone
 10)

Levels A, B or C.....	\$ 17.45	12.75
class b.....	\$ 18.64	12.90
Work performed in conjunction with site preparation not requiring the use of personal protective equipment;		
Also, Level D.....	\$ 16.45	12.75
class a.....	\$ 17.64	12.90

Zone 10

Laborers - hazardous waste
 abatement: (ALGER, BARAGA,
 CHIPPEWA, DELTA, DICKINSON,
 GOGEBIC, HOUGHTON, IRON,
 KEWEENAW, LUCE, MACKINAC,
 MARQUETTE, MENOMINEE,
 ONTONAGON AND SCHOOLCRAFT
 COUNTIES - Zone 11)

Levels A, B or C.....	\$ 23.58	12.90
Work performed in conjunction with site preparation not requiring the use of personal protective equipment;		
Also, Level D.....	\$ 22.58	12.90

Laborers - hazardous waste
 abatement: (ALLEGAN, BARRY,
 BERRIEN, BRANCH, CALHOUN,
 CASS, IONIA COUNTY (except
 the city of Portland);
 KALAMAZOO, KENT, LAKE,
 MANISTEE, MASON, MECOSTA,
 MONTCALM, MUSKEGON, NEWAYGO,
 OCEANA, OSCEOLA, OTTAWA, ST.
 JOSEPH AND VAN BUREN COUNTIES
 - Zone 9)

Levels A, B or C.....	\$ 21.80	12.90
Work performed in conjunction with site preparation not requiring the use of personal protective equipment;		
Also, Level D.....	\$ 20.80	12.90

Laborers - hazardous waste abatement: (ARENAC, BAY, CLARE, GLADWIN, GRATIOT, HURON, ISABELLA, MIDLAND, OGEMAW, ROSCOMMON, SAGINAW AND TUSCOLA COUNTIES - Zone 8)		
Levels A, B or C.....\$ 21.39		12.90
Work performed in conjunction with site preparation not requiring the use of personal protective equipment;		
Also, Level D.....\$ 20.80		12.90
Laborers - hazardous waste abatement: (CLINTON, EATON AND INGHAM COUNTIES; IONIA COUNTY (City of Portland); LIVINGSTON COUNTY (west of Oak Grove Rd., including the City of Howell) - Zone 6)		
Levels A, B or C.....\$ 25.64		12.90
Work performed in conjunction with site preparation not requiring the use of personal protective equipment;		
Also, Level D.....\$ 24.64		12.90
Laborers - hazardous waste abatement: (GENESEE, LAPEER AND SHIAWASSEE COUNTIES - Zone 7)		
Levels A, B or C.....\$ 24.20		13.80
Work performed in conjunction with site preparation not requiring the use of personal protective equipment;		
Also, Level D.....\$ 23.20		13.80
Laborers - hazardous waste abatement: (HILLSDALE, JACKSON AND LENAWEЕ COUNTIES - Zone 4)		
Levels A, B or C.....\$ 25.17		12.90
Work performed in conjunction with site preparation not requiring the use of personal protective equipment;		
Also, Level D.....\$ 24.17		12.90
Laborers - hazardous waste		

abatement: (LIVINGSTON COUNTY (east of Oak Grove Rd. and south of M-59, excluding the city of Howell); AND WASHTENAW COUNTY - Zone 3)		
Levels A, B or C.....	\$ 29.93	14.20
Work performed in conjunction with site preparation not requiring the use of personal protective equipment;		
Also, Level D.....	\$ 28.93	14.20
Laborers - hazardous waste abatement: (MACOMB AND WAYNE COUNTIES - Zone 1)		
Levels A, B or C.....	\$ 29.93	16.90
Work performed in conjunction with site preparation not requiring the use of personal protective equipment;		
Also, Level D.....	\$ 28.93	16.90
Laborers - hazardous waste abatement: (MONROE COUNTY - Zone 4)		
Levels A, B or C.....	\$ 31.75	14.90
Work performed in conjunction with site preparation not requiring the use of personal protective equipment;		
Also, Level D.....	\$ 31.75	14.90
Laborers - hazardous waste abatement: (OAKLAND COUNTY and the Northeast portion of LIVINGSTON COUNTY bordered by Oak Grove Road on the West and M-59 on the South - Zone 2)		
Level A, B, C.....	\$ 29.93	16.90
Work performed in conjunction with site preparation not requiring the use of personal protective equipment;		
Also, Level D.....	\$ 28.93	16.90
Laborers - hazardous waste abatement: (SANILAC AND ST. CLAIR COUNTIES - Zone 5)		
Levels A, B or C.....	\$ 25.75	16.35

Work performed in
 conjunction with site
 preparation not requiring
 the use of personal
 protective equipment;
 Also, Level D.....\$ 24.75 16.35

 LAB00259-001 09/01/2018

AREA 1: MACOMB, OAKLAND AND WAYNE COUNTIES
 AREA 2: ALCONA, ALGER, ALLEGAN, ALPENA, ANTRIM, ARENAC, BARAGA,
 BARRY, BAY, BENZIE, BERRIEN, BRANCH, CALHOUN, CASS, CHARLEVOIX,
 CHEBOYGAN, CHIPPEWA, CLARE, CLINTON, CRAWFORD, DELTA,
 DICKINSON, EATON, EMMET, GENESEE, GLADWIN, GOGEBIC, GRAND
 TRAVERSE, GRATIOT, HILLSDALE, HOUGHTON, HURON, INGHAM, IONIA,
 IOSCO, IRON, ISABELLA, JACKSON, KALAMAZOO, KALKASKA, KENT,
 KEWEENAW, LAKE, LAPEER, LEELANAU, LENAWEE, LIVINGSTON, LUCE,
 MACKINAC, MANISTEE, MARQUETTE, MASON, MECOSTA, MENOMINEE,
 MIDLAND, MISSAUKEE, MONROE, MONTCALM, MONTMORENCY, MUSKEGON,
 NEWAYGO, OCEANA, OGEMAW, ONTONAGON, OSCEOLA, OSCODA, OTSEGO,
 OTTAWA, PRESQUE ISLE, ROSCOMMON, SAGINAW, ST. CLARE, ST.
 JOSEPH, SANILAC, SCHOOLCRAFT, SHIAWASSEE, TUSCOLA, VAN BUREN,
 WASHTENAW AND WEXFORD COUNTIES

	Rates	Fringes
Laborers - tunnel, shaft and caisson:		
AREA 1		
GROUP 1.....	\$ 22.57	16.80
GROUP 2.....	\$ 22.68	16.80
GROUP 3.....	\$ 22.74	16.80
GROUP 4.....	\$ 22.92	16.80
GROUP 5.....	\$ 23.17	16.80
GROUP 6.....	\$ 23.50	16.80
GROUP 7.....	\$ 16.78	16.80
AREA 2		
GROUP 1.....	\$ 24.10	12.85
GROUP 2.....	\$ 24.19	12.85
GROUP 3.....	\$ 24.29	12.85
GROUP 4.....	\$ 24.45	12.85
GROUP 5.....	\$ 24.71	12.85
GROUP 6.....	\$ 25.02	12.85
GROUP 7.....	\$ 17.29	12.85

SCOPE OF WORK: Tunnel, shaft and caisson work of every type
 and description and all operations incidental thereto,
 including, but not limited to, shafts and tunnels for
 sewers, water, subways, transportation, diversion,

sewerage, caverns, shelters, aquifers, reservoirs, missile silos and steel sheeting for underground construction.

TUNNEL LABORER CLASSIFICATIONS

GROUP 1: Tunnel, shaft and caisson laborer, dump, shanty, hog house tender, testing (on gas) and watchman

GROUP 2: Manhole, headwall, catch basin builder, bricklayer tender, mortar machine and material mixer

GROUP 3: Air tool operator (jackhammer, bush hammer and grinder), first bottom, second bottom, cage tender, car pusher, carrier, concrete, concrete form, concrete repair, cement invert laborer, cement finisher, concrete shoveler, conveyor, floor, gasoline and electric tool operator, gunite, grout operator, welder, heading dinky person, inside lock tender, pea gravel operator, pump, outside lock tender, scaffold, top signal person, switch person, track, tugger, utility person, vibrator, winch operator, pipe jacking, wagon drill and air track operator and concrete saw operator (under 40 h.p.)

GROUP 4: Tunnel, shaft and caisson mucker, bracer, liner plate, long haul dinky driver and well point

GROUP 5: Tunnel, shaft and caisson miner, drill runner, key board operator, power knife operator, reinforced steel or mesh (e.g. wire mesh, steel mats, dowel bars, etc.)

GROUP 6: Dynamite and powder

GROUP 7: Restoration laborer, seeding, sodding, planting, cutting, mulching and top soil grading; and the restoration of property such as replacing mailboxes, wood chips, planter boxes, flagstones, etc.

LAB00334-001 09/01/2018

	Rates	Fringes
Laborers - open cut:		
ZONE 1 - MACOMB, OAKLAND		
AND WAYNE COUNTIES:		
GROUP 1.....	\$ 22.42	16.80
GROUP 2.....	\$ 22.53	16.80
GROUP 3.....	\$ 22.58	16.80
GROUP 4.....	\$ 22.66	16.80
GROUP 5.....	\$ 22.72	16.80

GROUP 6.....	\$ 20.17	16.80
GROUP 7.....	\$ 16.79	16.80
ZONE 2 - LIVINGSTON COUNTY (east of M-151 (Oak Grove Rd.)); MONROE AND WASHTENAW COUNTIES:		
GROUP 1.....	\$ 23.75	12.85
GROUP 2.....	\$ 23.86	12.85
GROUP 3.....	\$ 23.98	12.85
GROUP 4.....	\$ 24.05	12.85
GROUP 5.....	\$ 24.20	12.85
GROUP 6.....	\$ 21.50	12.85
GROUP 7.....	\$ 18.14	12.85
ZONE 3 - CLINTON, EATON, GENESEE, HILLSDALE AND INGHAM COUNTIES; IONIA COUNTY (City of Portland); JACKSON, LAPEER AND LENAWEЕ COUNTIES; LIVINGSTON COUNTY (west of M-151 Oak Grove Rd.); SANILAC, ST. CLAIR AND SHIAWASSEE COUNTIES:		
GROUP 1.....	\$ 21.94	12.85
GROUP 2.....	\$ 22.08	12.85
GROUP 3.....	\$ 22.20	12.85
GROUP 4.....	\$ 22.25	12.85
GROUP 5.....	\$ 22.39	12.85
GROUP 6.....	\$ 19.69	12.85
GROUP 7.....	\$ 16.84	12.85
ZONE 4 - ALCONA, ALLEGAN, ALPENA, ANTRIM, ARENAC, BARRY, BAY, BENZIE, BERRIEN, BRANCH, CALHOUN, CASS, CHARLEVOIX, CHEBOYGAN, CLARE, CRAWFORD, EMMET, GLADWIN, GRAND TRAVERSE, GRATIOT AND HURON COUNTIES; IONIA COUNTY (EXCEPT THE CITY OF PORTLAND); IOSCO, ISABELLA, KALAMAZOO, KALKASKA, KENT, LAKE, LEELANAU, MANISTEE, MASON, MECOSTA, MIDLAND, MISSAUKEE, MONTCALM, MONTMORENCY, MUSKEGON, NEWAYGO, OCEANA, OGEMAW, OSCEOLA, OSCODA, OTSEGO,		

OTTAWA, PRESQUE ISLE,
 ROSCOMMON, SAGINAW, ST.
 JOSEPH, TUSCOLA, VAN BUREN
 AND WEXFORD COUNTIES:

GROUP 1.....	\$ 20.97	12.85
GROUP 2.....	\$ 21.10	12.85
GROUP 3.....	\$ 21.21	12.85
GROUP 4.....	\$ 21.28	12.85
GROUP 5.....	\$ 21.40	12.85
GROUP 6.....	\$ 18.62	12.85
GROUP 7.....	\$ 16.96	12.85

ZONE 5 - ALGER, BARAGA,
 CHIPPEWA, DELTA,
 DICKINSON, GOGEBIC,
 HOUGHTON, IRON,
 KEWEENAW, LUCE, MACKINAC,
 MARQUETTE, MENOMINEE,
 ONTONAGON AND SCHOOLCRAFT
 COUNTIES:

GROUP 1.....	\$ 21.19	12.85
GROUP 2.....	\$ 21.33	12.85
GROUP 3.....	\$ 21.46	12.85
GROUP 4.....	\$ 21.51	12.85
GROUP 5.....	\$ 21.56	12.85
GROUP 6.....	\$ 18.94	12.85
GROUP 7.....	\$ 17.05	12.85

SCOPE OF WORK:

Open cut construction work shall be construed to mean work which requires the excavation of earth including industrial, commercial and residential building site excavation and preparation, land balancing, demolition and removal of concrete and underground appurtenances, grading, paving, sewers, utilities and improvements; retention, oxidation, flocculation and irrigation facilities, and also including but not limited to underground piping, conduits, steel sheeting for underground construction, and all work incidental thereto, and general excavation. For all areas except the Upper Peninsula, open cut construction work shall also be construed to mean waterfront work, piers, docks, seawalls, breakwalls, marinas and all incidental work. Open cut construction work shall not include any structural modifications, alterations, additions and repairs to buildings, or highway work, including roads, streets, bridge construction and parking lots or steel erection work and excavation for the building itself and back filling inside of and within 5 ft. of the building and foundations, footings and piers for the building. Open cut construction work shall not include any work covered under

Tunnel, Shaft and Caisson work.

OPEN CUT LABORER CLASSIFICATIONS

GROUP 1: Construction laborer

GROUP 2: Mortar and material mixer, concrete form person, signal person, well point person, manhole, headwall and catch basin builder, headwall, seawall, breakwall and dock builder

GROUP 3: Air, gasoline and electric tool operator, vibrator operator, driller, pump person, tar kettle operator, bracer, rodder, reinforced steel or mesh person (e.g., wire mesh, steel mats, dowel bars, etc.), welder, pipe jacking and boring person, wagon drill and air track operator and concrete saw operator (under 40 h.p.), windlass and tugger person and directional boring person

GROUP 4: Trench or excavating grade person

GROUP 5: Pipe layer (including crock, metal pipe, multi-plate or other conduits)

GROUP 6: Grouting man, audio-visual television operations and all other operations in connection with closed circuit television inspection, pipe cleaning and pipe relining work and the installation and repair of water service pipe and appurtenances

GROUP 7: Restoration laborer, seeding, sodding, planting, cutting, mulching and top soil grading; and the restoration of property such as replacing mailboxes, wood chips, planter boxes, flagstones, etc.

* LAB00465-001 06/01/2020

LABORER: Highway, Bridge and Airport Construction

AREA 1: GENESEE, MACOMB, MONROE, OAKLAND, WASHTENAW AND WAYNE COUNTIES

AREA 2: ALLEGAN, BARRY, BAY, BERRIEN, BRANCH, CALHOUN, CASS, CLINTON, EATON, GRATIOT, HILLSDALE, HURON, INGHAM, JACKSON, KALAMAZOO, LAPEER, LENAWEE, LIVINGSTON, MIDLAND, MUSKEGON, SAGINAW, SANILAC, SHIAWASSEE, ST. CLAIR, ST. JOSEPH, TUSCOLA AND VAN BUREN COUNTIES

AREA 3: ALCONA, ALPENA, ANTRIM, ARENAC, BENZIE, CHARLEVOIX,

CHEBOYGAN, CLARE, CRAWFORD, EMMET, GLADWIN, GRAND TRAVERSE, IONIA, IOSCO, ISABELLA, KALKASKA, KENT, LAKE, LEELANAU, MANISTEE, MASON, MECOSTA, MISSAUKEE, MONTCALM, MONTMORENCY, NEWAYGO, OCEANA, OGEMAW, OSCEOLA, OSCODA, OTSEGO, OTTAWA, PRESQUE ISLE, ROSCOMMON AND WEXFORD COUNTIES

AREA 4: ALGER, BARAGA, CHIPPEWA, DELTA, DICKINSON, GOGEBIC, HOUGHTON, IRON, KEWEENAW, LUCE, MACKINAC, MARQUETTE, MENOMINEE, ONTONAGON AND SCHOOLCRAFT COUNTIES

	Rates	Fringes
LABORER (AREA 1)		
GROUP 1.....	\$ 26.22	12.90
GROUP 2.....	\$ 26.43	12.90
GROUP 3.....	\$ 26.72	12.90
GROUP 4.....	\$ 27.16	12.90
GROUP 5.....	\$ 26.78	12.90
GROUP 6.....	\$ 27.21	12.90
LABORER (AREA 2)		
GROUP 1.....	\$ 26.92	12.90
GROUP 2.....	\$ 27.12	12.90
GROUP 3.....	\$ 27.36	12.90
GROUP 4.....	\$ 27.71	12.90
GROUP 5.....	\$ 27.58	12.90
GROUP 6.....	\$ 27.92	12.90
LABORER (AREA 3)		
GROUP 1.....	\$ 26.22	12.90
GROUP 2.....	\$ 26.43	12.90
GROUP 3.....	\$ 26.72	12.90
GROUP 4.....	\$ 27.16	12.90
GROUP 5.....	\$ 26.78	12.90
GROUP 6.....	\$ 27.21	12.90
LABORER (AREA 4)		
GROUP 1.....	\$ 26.22	12.90
GROUP 2.....	\$ 26.43	12.90
GROUP 3.....	\$ 26.72	12.90
GROUP 4.....	\$ 27.16	12.90
GROUP 5.....	\$ 26.78	12.90
GROUP 6.....	\$ 27.21	12.90

LABORER CLASSIFICATIONS

GROUP 1: Asphalt shoveler or loader; asphalt plant misc.; burlap person; yard person; dumper (wagon, truck, etc.); joint filling laborer; miscellaneous laborer; unskilled laborer; sprinkler laborer; form setting laborer; form stripper; pavement reinforcing; handling and placing (e.g., wire mesh, steel mats, dowel bars); mason's tender or

bricklayer's tender on manholes; manhole builder; headwalls, etc.; waterproofing,(other than buildings) seal coating and slurry mix, shoring, underpinning; pressure grouting; bridge pin and hanger removal; material recycling laborer; horizontal paver laborer (brick, concrete, clay, stone and asphalt); ground stabilization and modification laborer; grouting; waterblasting; top person; railroad track and trestle laborer; carpenters' tender; guard rail builders' tender; earth retention barrier and wall and M.S.E. wall installer's tender; highway and median installer's tender(including sound, retaining, and crash barriers); fence erector's tender; asphalt raker tender; sign installer; remote control operated equipment.

GROUP 2: Mixer operator (less than 5 sacks); air or electric tool operator (jackhammer, etc.); spreader; boxperson (asphalt, stone, gravel); concrete paddler; power chain saw operator; paving batch truck dumper; tunnel mucker (highway work only); concrete saw (under 40 h.p.) and dry pack machine; roto-mill grounds person.

GROUP 3: Tunnel miner (highway work only); finishers tenders; guard rail builders; highway and median barrier installer; earth retention barrier and wall and M.S.E. wall installer's (including sound, retaining and crash barriers); fence erector; bottom person; powder person; wagon drill and air track operator; diamond and core drills; grade checker; certified welders; curb and side rail setter's tender.

GROUP 4: Asphalt raker

GROUP 5: Pipe layers, oxy-gun

GROUP 6: Line-form setter for curb or pavement; asphalt screed checker/screw man on asphalt paving machines.

LAB01076-005 04/01/2019

MICHIGAN STATEWIDE

	Rates	Fringes
LABORER (DISTRIBUTION WORK)		
Zone 1.....	\$ 21.47	12.90
Zone 2.....	\$ 19.77	12.90
Zone 3.....	\$ 17.95	12.90
Zone 4.....	\$ 17.32	12.90
Zone 5.....	\$ 17.30	12.90

DISTRIBUTION WORK - The construction, installation, treating and reconditioning of distribution pipelines transporting coal, oil, gas or other similar materials, vapors or liquids, including pipelines within private property boundaries, up to and including the meter settings on residential, commercial, industrial, institutional, private and public structures. All work covering pumping stations and tank farms not covered by the Building Trades Agreement. Other distribution lines with the exception of sewer, water and cable television are included.

Underground Duct Layer Pay: \$.40 per hour above the base pay rate.

Zone 1 - Macomb, Oakland and Wayne

Zone 2 - Monroe and Washtenaw

Zone 3 - Bay, Genesee, Lapeer, Midland, Saginaw, Sanilac, Shiawassee and St. Clair

Zone 4 - Alger, Baraga, Chippewa, Delta, Dickinson, Gogebic, Houghton, Iron, Keweenaw, Luce, Mackinac, Marquette, Menominee, Ontonagon and Schoolcraft

Zone 5 - Remaining Counties in Michigan

 PAIN0022-002 07/01/2008

HILLSDALE, JACKSON AND LENAWEE COUNTIES; LIVINGSTON COUNTY (east of the eastern city limits of Howell, not including the city of Howell, north to the Genesee County line and south to the Washtenaw County line); MACOMB, MONROE, OAKLAND, WASHTENAW AND WAYNE COUNTIES:

	Rates	Fringes
PAINTER.....	\$ 25.06	14.75

FOOTNOTES: For all spray work and journeyman rigging for spray work, also blowing off, \$.80 per hour additional (applies only to workers doing rigging for spray work on off the floor work. Does not include setting up or moving rigging on floor surfaces, nor does it apply to workers engaged in covering up or tending spray equipment. For all sandblasting and spray work performed on highway bridges, overpasses, tanks or steel, \$.80 per hour additional. For all brushing, cleaning and other preparatory work (other than spraying or steeplejack work) at scaffold heights of fifty (50) feet from the ground or higher, \$.50 per hour additional. For all preparatorial work and painting

performed on open steel under forty (40) feet when no scaffolding is involved, \$0.50 per hour additional. For all swing stage work-window jacks and window belts-exterior and interior, \$0.50 per hour additional. For all spray work and sandblaster work to a scaffold height of forty (40) feet above the floor level, \$0.80 per hour additional. For all preparatorial work and painting on all highway bridges or overpasses up to forty (40) feet in height, \$0.50 per hour additional. For all steeplejack work performed where the elevation is forty (40) feet or more, \$1.25 per hour additional.

 PAIN0312-001 06/01/2018

EXCLUDES: ALLEGAN COUNTY (Townships of Dorr, Fillmore, Heath, Hopkins, Laketown, Leighton, Manlius, Monterey, Overisel, Salem, Saugatuck and Wayland); INCLUDES: Barry, Berrien, Branch, Calhoun, Cass, Hillsdale, Kalamazoo, St. Joseph, Van Buren

	Rates	Fringes
PAINTER		
Brush and roller.....	\$ 23.74	13.35
Spray, Sandblast, Sign		
Painting.....	\$ 24.94	13.35

 PAIN0845-003 05/10/2018

CLINTON COUNTY; EATON COUNTY (does not include the townships of Bellevue and Olivet); INGHAM COUNTY; IONIA COUNTY (east of Hwy. M 66); LIVINGSTON COUNTY (west of the eastern city limits of Howell, including the city of Howell, north to the Genesee County line and south to the Washtenaw County line); AND SHIAWASSEE COUNTY (Townships of Bennington, Laingsbury and Perry):

	Rates	Fringes
PAINTER.....	\$ 25.49	13.74

 PAIN0845-015 05/10/2018

MUSKEGON COUNTY; NEWAYGO COUNTY (except the Townships of Barton, Big Prairie, Brooks, Croton, Ensley, Everett, Goodwell, Grant, Home, Monroe, Norwich and Wilcox); OCEANA COUNTY; OTTAWA COUNTY (except the townships of Allendale, Blendone, Chester,

Georgetown, Holland, Jamestown, Olive, Park, Polkton, Port Sheldon, Tallmadge, Wright and Zeeland):

	Rates	Fringes
PAINTER.....	\$ 25.49	13.74

PAIN0845-018 05/10/2018

ALLEGAN COUNTY (Townships of Dorr, Fillmore, Heath, Hopkins, Laketown, Leighton, Manlius, Monterey, Overisel, Salem, Saugatuck and Wayland); IONIA COUNTY (west of Hwy. M-66); KENT, MECOSTA AND MONTCALM COUNTIES; NEWAYGO COUNTY (Townships of Barton, Big Prairie, Brooks, Croton, Ensley, Everett, Goodwell, Grant, Home, Monroe, Norwich and Wilcox); OSCEOLA COUNTY (south of Hwy. #10); OTTAWA COUNTY (Townships of Allendale, Blendone, Chester, Georgetown, Holland, Jamestown, Olive, Park, Polkton, Port Sheldon, Tallmadge, Wright and Zeeland):

	Rates	Fringes
PAINTER.....	\$ 25.49	13.74

FOOTNOTES: Lead abatement work: \$1.00 per hour additional.

PAIN1011-003 06/02/2019

ALGER, BARAGA, CHIPPEWA, DELTA, DICKINSON, GOGEBIC, HOUGHTON, IRON, KEWEENAW, LUCE, MACKINAC, MARQUETTE, MENOMINEE, ONTONAGON AND SCHOOLCRAFT COUNTIES:

	Rates	Fringes
PAINTER.....	\$ 25.76	13.33

FOOTNOTES: High pay (bridges, overpasses, watertower): 30 to 80 ft.: \$.65 per hour additional. 80 ft. and over: \$1.30 per hour additional.

PAIN1474-002 06/01/2010

HURON COUNTY; LAPEER COUNTY (east of Hwy. M-53); ST. CLAIR, SANILAC AND TUSCOLA COUNTIES:

Rates	Fringes
-------	---------

PAINTER.....\$ 23.79 12.02

FOOTNOTES: Lead abatement work: \$1.00 per hour additional.
 Work with any hazardous material: \$1.00 per hour additional.
 Sandblasting, steam cleaning and acid cleaning: \$1.00 per hour additional.
 Ladder work at or above 40 ft., scaffold work at or above 40 ft., swing stage, boatswain chair, window jacks and all work performed over a falling height of 40 ft.: \$1.00 per hour additional.
 Spray gun work, pick pullers and those handling needles, blowing off by air pressure, and any person rigging (setting up and moving off the ground): \$1.00 per hour additional.
 Steeplejack, tanks, gas holders, stacks, flag poles, radio towers and beacons, power line towers, bridges, etc.: \$1.00 per hour additional, paid from the ground up.

 PAIN1803-003 06/01/2019

ALCONA, ALPENA, ANTRIM, ARENAC, BAY, BENZIE, CHARLEVOIX, CHEBOYGAN, CLARE, CRAWFORD, EMMET, GLADWIN, GRAND TRAVERSE, GRATIOT, IOSCO, ISABELLA, KALKASKA, LAKE, LEELANAU, MANISTEE, MASON, MIDLAND, MISSAUKEE, MONTMORENCY AND OGEMAW COUNTIES; OSCEOLA COUNTY (north of Hwy. #10); OSCODA, OTSEGO, PRESQUE ISLE, ROSCOMMON, SAGINAW AND WEXFORD COUNTIES:

Rates Fringes

PAINTER

Work performed on water, bridges over water or moving traffic, radio and powerline towers, elevated tanks, steeples, smoke stacks over 40 ft. of falling heights, recovery of lead-based paints and any work associated with industrial plants, except maintenance of industrial

plants.....\$ 25.39 14.68

All other work, including maintenance of industrial plant.....\$ 25.39 14.68

FOOTNOTES: Spray painting, sandblasting, blowdown associated with spraying and blasting, water blasting and work

involving a swing stage, boatswain chair or spider: \$1.00 per hour additional. All work performed inside tanks, vessels, tank trailers, railroad cars, sewers, smoke stacks, boilers or other spaces having limited egress not including buildings, opentop tanks, pits, etc.: \$1.25 per hour additional.

 PLAS0514-001 06/01/2018

ZONE 1: GENESEE, LIVINGSTON, MACOMB, MONROE, OAKLAND, SAGINAW, WASHTENAW AND WAYNE COUNTIES

ZONE 2: ALCONA, ALGER, ALLEGAN, ALPENA, ANTRIM, ARENAC, BARAGA, BARRY, BAY, BENZIE, BERRIEN, BRANCH, CALHOUN, CASS, CHARLEVOIX, CHEBOYGAN, CHIPPEWA, CLARE, CLINTON, CRAWFORD, DELTA, DICKINSON, EATON, EMMET, GLADWIN, GOGEBIC, GRAND TRAVERSE, GRATIOT, HILLSDALE, HOUGHTON, HURON, INGHAM, IONIA, IOSCO, IRON, ISABELLA, JACKSON, KALAMAZOO, KALKASKA, KENT, KEWEENAW, LAKE, LAPEER, LEELANAU, LENAWEE, LUCE, MACKINAC, MANISTEE, MARQUETTE, MASON, MECOSTA, MENOMINEE, MIDLAND, MISSAUKEE, MONTCALM, MONTMORENCY, MUSKEGON, NEWAYGO, OCEANA, OGEMAW, ONTONAGON, OSCEOLA, OSCODA, OTSEGO, OTTAWA, PRESQUE ISLE, ROSCOMMON, SANILAC, SCHOOLCRAFT, SHIAWASSEE, ST. CLAIR, ST. JOSEPH, TUSCOLA, VAN BUREN AND WEXFORD COUNTIES

	Rates	Fringes
CEMENT MASON/CONCRETE FINISHER		
ZONE 1.....	\$ 31.47	13.81
ZONE 2.....	\$ 29.97	13.81

 PLUM0190-003 05/01/2015

ALCONA, ALGER, ALLEGAN, ALPENA, ANTRIM, ARENAC, BARAGA, BARRY, BAY, BENZIE, BERRIEN, BRANCH, CALHOUN, CASS, CHARLEVOIX, CHEBOYGAN, CHIPPEWA, CLARE, CLINTON, CRAWFORD, DELTA, DICKINSON, EATON, EMMET, GENESEE, GLADWIN, GOGEBIC, GRAND TRAVERSE, GRATIOT, HILLSDALE, HOUGHTON, HURON, INGHAM, IONIA, IOSCO, IRON, ISABELLA, JACKSON, KALAMAZOO, KALKASKA, KENT, KEWEENAW, LAKE, LAPEER, LEELANAU, LENAWEE, LIVINGSTON, LUCE, MACKINAC, MACOMB, MANISTEE, MARQUETTE, MASON, MECOSTA, MENOMINEE, MIDLAND, MISSAUKEE, MONTCALM, MONTMORENCY, MONROE, MUSKEGON, NEWAYGO, OAKLAND, OCEANA, OGEMAW, ONTONAGON, OSCEOLA, OSCODA, OTSEGO, OTTAWA, PRESQUE ISLE, ROSCOMMON, SAGINAW, ST. CLARE, ST. JOSEPH, SANILAC, SCHOOLCRAFT, SHIAWASSEE, TUSCOLA, VAN BUREN, WASHTENAW, WAYNE AND WEXFORD COUNTIES

	Rates	Fringes
Plumber/Pipefitter - gas distribution pipeline:		
Welding in conjunction with gas distribution pipeline work.....	\$ 33.03	20.19
All other work:.....	\$ 24.19	12.28

TEAM0007-004 06/01/2020

AREA 1: ALCONA, ALGER, ALLEGAN, ALPENA, ANTRIM, ARENAC, BARAGA, BARRY, BAY, BENZIE, BERRIEN, BRANCH, CALHOUN, CASS, CHARLEVOIX, CHEBOYGAN, CHIPPEWA, CLARE, CLINTON, CRAWFORD, DELTA, DICKINSON, EATON, EMMET, GLADWIN, GOGEBIC, GRAND TRAVERSE, GRATIOT, HILLSDALE, HOUGHTON, HURON, INGHAM, IONIA, IOSCO, IRON, ISABELLA, JACKSON, KALAMAZOO, KALKASKA, KENT, KEWEENAW, LAKE, LAPEER, LEELANAU, LENAWEE, LUCE, MACKINAC, MANISTEE, MARQUETTE, MASON, MECOSTA, MENOMINEE, MIDLAND, MISSAUKEE, MONTCALM, MONTMORENCY, MUSKEGON, NEWAYGO, OCEANA, OGEMAW, ONTONAGON, OSCEOLA, OSCODA, OTSEGO, OTTAWA, PRESQUE ISLE, ROSCOMMON, SAGINAW, SANILAC, SCHOOLCRAFT, SHIAWASSEE, ST. CLAIR, ST. JOSEPH, TUSCOLA, VAN BUREN AND WEXFORD COUNTIES

AREA 2: GENESEE, LIVINGSTON, MACOMB, MONROE, OAKLAND, WASHTENAW AND WAYNE COUNTIES

	Rates	Fringes
TRUCK DRIVER		
AREA 1		
Euclids, double bottoms and lowboys.....	\$ 28.05	.50 + a+b
Trucks under 8 cu. yds.....	\$ 27.80	.50 + a+b
Trucks, 8 cu. yds. and over.....	\$ 27.90	.50 + a+b
AREA 2		
Euclids, double bottomms and lowboys.....	\$ 24.895	.50 + a+b
Euclids, double bottoms and lowboys.....	\$ 28.15	.50 + a+b
Trucks under 8 cu. yds.....	\$ 27.90	.50 + a+b
Trucks, 8 cu. yds. and over.....	\$ 28.00	.50 + a+b

Footnote:

- a. \$47.70 per week
 - b. \$68.70 daily
-

TEAM0247-004 04/01/2013

AREA 1: ALCONA, ALGER, ALLEGAN, ALPENA, ANTRIM, ARENAC, BARAGA, BARRY, BAY, BENZIE, BERRIEN, BRANCH, CALHOUN, CASS, CHARLEVOIX, CHEBOYGAN, CHIPPEWA, CLARE, CLINTON, CRAWFORD, DELTA, DICKINSON, EATON, EMMET, GLADWIN, GOGEBIC, GRAND TRAVERSE, GRATIOT, HILLSDALE, HOUGHTON, HURON, INGHAM, IONIA, IOSCO, IRON, ISABELLA, JACKSON, KALAMAZOO, KALKASKA, KENT, KEWEENAW, LAKE, LAPEER, LEELANAU, LENAWEE, LUCE, MACKINAC, MANISTEE, MARQUETTE, MASON, MECOSTA, MENOMINEE, MIDLAND, MISSAUKEE, MONTCALM, MONTMORENCY, MUSKEGON, NEWAYGO, OCEANA, OGEMAW, ONTONAGON, OSCEOLA, OSCODA, OTSEGO, OTTAWA, PRESQUE ISLE, ROSCOMMON, SANILAC, SCHOOLCRAFT, SHIAWASSEE, SAGINAW, ST. CLAIR, ST. JOSEPH, TUSCOLA, VAN BUREN AND WEXFORD COUNTIES

AREA 2: GENESEE, LIVINGSTON, MACOMB, MONROE, OAKLAND, WASHTENAW AND WAYNE COUNTIES

	Rates	Fringes
Sign Installer		
AREA 1		
GROUP 1.....	\$ 21.78	11.83
GROUP 2.....	\$ 25.27	11.8375
AREA 2		
GROUP 1.....	\$ 22.03	11.83
GROUP 2.....	\$ 25.02	11.8375

FOOTNOTE:

a. \$132.70 per week, plus \$17.80 per day.

SIGN INSTALLER CLASSIFICATIONS:

GROUP 1: performs all necessary labor and uses all tools required to construct and set concrete forms required in the installation of highway and street signs

GROUP 2: performs all miscellaneous labor, uses all hand and power tools, and operates all other equipment, mobile or otherwise, required for the installation of highway and street signs

TEAM0247-010 04/01/2018

AREA 1: LAPEER AND SHIAWASSEE COUNTIES

AREA 2: GENESEE, MACOMB, MONROE, OAKLAND, ST. CLAIR, WASHTENAW AND WAYNE COUNTIES

	Rates	Fringes
TRUCK DRIVER (Underground construction)		
AREA 1		
GROUP 1.....	\$ 23.82	19.04
GROUP 2.....	\$ 23.91	19.04
GROUP 3.....	\$ 24.12	19.04
AREA 2		
GROUP 1.....	\$ 24.12	19.04
GROUP 2.....	\$ 24.26	19.04
GROUP 3.....	\$ 24.45	19.04

PAID HOLIDAYS: New Year's Day, Memorial Day, Fourth of July, Labor Day, Thanksgiving Day and Christmas Day.

SCOPE OF WORK: Excavation, site preparation, land balancing, grading, sewers, utilities and improvements; also including but not limited to, tunnels, underground piping, retention, oxidation, flocculation facilities, conduits, general excavation and steel sheeting for underground construction. Underground construction work shall not include any structural modifications, alterations, additions and repairs to buildings or highway work, including roads, streets, bridge construction and parking lots or steel erection.

TRUCK DRIVER CLASSIFICATIONS

GROUP 1: Truck driver on all trucks (EXCEPT dump trucks of 8 cubic yards capacity or over, pole trailers, semis, low boys, Euclid, double bottom and fuel trucks)

GROUP 2: Truck driver on dump trucks of 8 cubic yards capacity or over, pole trailers, semis and fuel trucks

GROUP 3: Truck driver on low boy, Euclid and double bottom

SUMI2002-001 05/01/2002

	Rates	Fringes
Flag Person.....	\$ 10.10	0.00

LINE PROTECTOR (ZONE 1:

GENESEE, MACOMB, MONROE, OAKLAND, WASHTENAW AND WAYNE)....\$ 20.30	12.90
LINE PROTECTOR (ZONE 2: STATEWIDE (EXCLUDING GENESEE, MACOMB, MONROE, OAKLAND, WASHTENAW AND WAYNE).....\$ 18.02	12.90
Pavement Marking Machine (ZONE 1: GENESEE, MACOMB, MONROE, OAKLAND, WASHTENAW AND WAYNE COUNTIES) Group 1.....\$ 27.07	12.90
Pavement Marking Machine (ZONE 1: GENESEE, MACOMB, MONROE, OAKLAND, WASHTENAW AND WAYNE) Group 2.....\$ 24.36	12.90
Pavement Marking Machine (ZONE 2: STATEWIDE (EXCLUDING GENESEE, MACOMB, MONROE, OAKLAND, WASHTENAW AND WAYNE COUNTIES) Group 1.....\$ 24.02	12.90
Pavement Marking Machine (ZONE 2: STATEWIDE (EXCLUDING GENESEE, MACOMB, MONROE, OAKLAND, WASHTENAW AND WAYNE) Group 2.....\$ 21.62	12.90

WORK CLASSIFICATIONS:

PAVEMENT MARKER GROUP 1: Drives or operates a truck mounted striper, grinder, blaster, groover, or thermoplastic melter for the placement or removal of temporary or permanent pavement markings or markers.

PAVEMENT MARKER GROUP 2: Performs all functions involved for the placement or removal of temporary or permanent pavement markings or markers not covered by the classification of Pavement Marker Group 1 or Line Protector.

LINE PROTECTOR: Performs all operations for the protection or removal of temporary or permanent pavement markings or markers in a moving convoy operation not performed by the classification of Pavement Marker Group 1. A moving convoy operation is comprised of only Pavement Markers Group 1 and

Line Protectors.

WELDERS - Receive rate prescribed for craft performing operation to which welding is incidental.

=====
Note: Executive Order (EO) 13706, Establishing Paid Sick Leave for Federal Contractors applies to all contracts subject to the Davis-Bacon Act for which the contract is awarded (and any solicitation was issued) on or after January 1, 2017. If this contract is covered by the EO, the contractor must provide employees with 1 hour of paid sick leave for every 30 hours they work, up to 56 hours of paid sick leave each year. Employees must be permitted to use paid sick leave for their own illness, injury or other health-related needs, including preventive care; to assist a family member (or person who is like family to the employee) who is ill, injured, or has other health-related needs, including preventive care; or for reasons resulting from, or to assist a family member (or person who is like family to the employee) who is a victim of, domestic violence, sexual assault, or stalking. Additional information on contractor requirements and worker protections under the EO is available at www.dol.gov/whd/govcontracts.

Unlisted classifications needed for work not included within the scope of the classifications listed may be added after award only as provided in the labor standards contract clauses (29CFR 5.5 (a) (1) (ii)).

The body of each wage determination lists the classification and wage rates that have been found to be prevailing for the cited type(s) of construction in the area covered by the wage determination. The classifications are listed in alphabetical order of ""identifiers"" that indicate whether the particular rate is a union rate (current union negotiated rate for local), a survey rate (weighted average rate) or a union average rate (weighted union average rate).

Union Rate Identifiers

A four letter classification abbreviation identifier enclosed in dotted lines beginning with characters other than ""SU"" or ""UAVG"" denotes that the union classification and rate were

prevailing for that classification in the survey. Example: PLUM0198-005 07/01/2014. PLUM is an abbreviation identifier of the union which prevailed in the survey for this classification, which in this example would be Plumbers. 0198 indicates the local union number or district council number where applicable, i.e., Plumbers Local 0198. The next number, 005 in the example, is an internal number used in processing the wage determination. 07/01/2014 is the effective date of the most current negotiated rate, which in this example is July 1, 2014.

Union prevailing wage rates are updated to reflect all rate changes in the collective bargaining agreement (CBA) governing this classification and rate.

Survey Rate Identifiers

Classifications listed under the "SU" identifier indicate that no one rate prevailed for this classification in the survey and the published rate is derived by computing a weighted average rate based on all the rates reported in the survey for that classification. As this weighted average rate includes all rates reported in the survey, it may include both union and non-union rates. Example: SULA2012-007 5/13/2014. SU indicates the rates are survey rates based on a weighted average calculation of rates and are not majority rates. LA indicates the State of Louisiana. 2012 is the year of survey on which these classifications and rates are based. The next number, 007 in the example, is an internal number used in producing the wage determination. 5/13/2014 indicates the survey completion date for the classifications and rates under that identifier.

Survey wage rates are not updated and remain in effect until a new survey is conducted.

Union Average Rate Identifiers

Classification(s) listed under the UAVG identifier indicate that no single majority rate prevailed for those classifications; however, 100% of the data reported for the classifications was union data. EXAMPLE: UAVG-OH-0010 08/29/2014. UAVG indicates that the rate is a weighted union average rate. OH indicates the state. The next number, 0010 in the example, is an internal number used in producing the wage determination. 08/29/2014 indicates the survey completion date for the classifications and rates under that identifier.

A UAVG rate will be updated once a year, usually in January of each year, to reflect a weighted average of the current negotiated/CBA rate of the union locals from which the rate is

based.

WAGE DETERMINATION APPEALS PROCESS

1.) Has there been an initial decision in the matter? This can be:

- * an existing published wage determination
- * a survey underlying a wage determination
- * a Wage and Hour Division letter setting forth a position on a wage determination matter
- * a conformance (additional classification and rate) ruling

On survey related matters, initial contact, including requests for summaries of surveys, should be with the Wage and Hour Regional Office for the area in which the survey was conducted because those Regional Offices have responsibility for the Davis-Bacon survey program. If the response from this initial contact is not satisfactory, then the process described in 2.) and 3.) should be followed.

With regard to any other matter not yet ripe for the formal process described here, initial contact should be with the Branch of Construction Wage Determinations. Write to:

Branch of Construction Wage Determinations
Wage and Hour Division
U.S. Department of Labor
200 Constitution Avenue, N.W.
Washington, DC 20210

2.) If the answer to the question in 1.) is yes, then an interested party (those affected by the action) can request review and reconsideration from the Wage and Hour Administrator (See 29 CFR Part 1.8 and 29 CFR Part 7). Write to:

Wage and Hour Administrator
U.S. Department of Labor
200 Constitution Avenue, N.W.
Washington, DC 20210

The request should be accompanied by a full statement of the interested party's position and by any information (wage payment data, project description, area practice material, etc.) that the requestor considers relevant to the issue.

3.) If the decision of the Administrator is not favorable, an interested party may appeal directly to the Administrative Review Board (formerly the Wage Appeals Board). Write to:

Administrative Review Board
U.S. Department of Labor
200 Constitution Avenue, N.W.
Washington, DC 20210

4.) All decisions by the Administrative Review Board are final.

=====

END OF GENERAL DECISION

"

CITY OF ANN ARBOR
LIVING WAGE ORDINANCE DECLARATION OF COMPLIANCE

The Ann Arbor Living Wage Ordinance (Section 1:811-1:821 of Chapter 23 of Title I of the Code) requires that an employer who is (a) a contractor providing services to or for the City for a value greater than \$10,000 for any twelve-month contract term, or (b) a recipient of federal, state, or local grant funding administered by the City for a value greater than \$10,000, or (c) a recipient of financial assistance awarded by the City for a value greater than \$10,000, shall pay its employees a prescribed minimum level of compensation (i.e., Living Wage) for the time those employees perform work on the contract or in connection with the grant or financial assistance. The Living Wage must be paid to these employees for the length of the contract/program.

Companies employing fewer than 5 persons and non-profits employing fewer than 10 persons are exempt from compliance with the Living Wage Ordinance. If this exemption applies to your company/non-profit agency please check here No. of employees__

The Contractor or Grantee agrees:

- (a) To pay each of its employees whose wage level is not required to comply with federal, state or local prevailing wage law, for work covered or funded by a contract with or grant from the City, no less than the Living Wage. The current Living Wage is defined as \$13.91/hour for those employers that provide employee health care (as defined in the Ordinance at Section 1:815 Sec. 1 (a)), or no less than \$15.51/hour for those employers that do not provide health care. The Contractor or Grantor understands that the Living Wage is adjusted and established annually on April 30 in accordance with the Ordinance and covered employers shall be required to pay the adjusted amount thereafter to be in compliance with Section 1:815(3).

Check the applicable box below which applies to your workforce

Employees who are assigned to any covered City contract/grant will be paid at or above the applicable living wage without health benefits

Employees who are assigned to any covered City contract/grant will be paid at or above the applicable living wage with health benefits

- (b) To post a notice approved by the City regarding the applicability of the Living Wage Ordinance in every work place or other location in which employees or other persons contracting for employment are working.
- (c) To provide to the City payroll records or other documentation within ten (10) business days from the receipt of a request by the City.
- (d) To permit access to work sites to City representatives for the purposes of monitoring compliance, and investigating complaints or non-compliance.
- (e) To take no action that would reduce the compensation, wages, fringe benefits, or leave available to any employee covered by the Living Wage Ordinance or any person contracted for employment and covered by the Living Wage Ordinance in order to pay the living wage required by the Living Wage Ordinance.

The undersigned states that he/she has the requisite authority to act on behalf of his/her employer in these matters and has offered to provide the services or agrees to accept financial assistance in accordance with the terms of the Living Wage Ordinance. The undersigned certifies that he/she has read and is familiar with the terms of the Living Wage Ordinance, obligates the Employer/Grantee to those terms and acknowledges that if his/her employer is found to be in violation of Ordinance it may be subject to civil penalties and termination of the awarded contract or grant of financial assistance.

 Company Name

 Street Address

 Signature of Authorized Representative

 Date

 City, State, Zip

 Print Name and Title

 Phone/Email address

CITY OF ANN ARBOR LIVING WAGE ORDINANCE

RATE EFFECTIVE APRIL 30, 2020 - ENDING APRIL 29, 2021

\$13.91 per hour

If the employer provides health care benefits*

\$15.51 per hour

If the employer does **NOT** provide health care benefits*

Employers providing services to or for the City of Ann Arbor or recipients of grants or financial assistance from the City of Ann Arbor for a value of more than \$10,000 in a twelve-month period of time must pay those employees performing work on a City of Ann Arbor contract or grant, the above living wage.

ENFORCEMENT

The City of Ann Arbor may recover back wages either administratively or through court action for the employees that have been underpaid in violation of the law. Persons denied payment of the living wage have the right to bring a civil action for damages in addition to any action taken by the City.

Violation of this Ordinance is punishable by fines of not more than \$500/violation plus costs, with each day being considered a separate violation. Additionally, the City of Ann Arbor has the right to modify, terminate, cancel or suspend a contract in the event of a violation of the Ordinance.

* Health Care benefits include those paid for by the employer or making an employer contribution toward the purchase of health care. The employee contribution must not exceed \$.50 an hour for an average work week; and the employer cost or contribution must equal no less than \$1/hr for the average work week.

The Law Requires Employers to Display This Poster Where Employees Can Readily See It.

**For Additional Information or to File a Complaint contact
Colin Spencer at 734/794-6500 or cspencer@a2gov.org**



Vendor Conflict of Interest Disclosure Form
--

All vendors interested in conducting business with the City of Ann Arbor must complete and return the Vendor Conflict of Interest Disclosure Form in order to be eligible to be awarded a contract. Please note that all vendors are subject to comply with the City of Ann Arbor’s conflict of interest policies as stated within the certification section below.

If a vendor has a relationship with a City of Ann Arbor official or employee, an immediate family member of a City of Ann Arbor official or employee, the vendor shall disclose the information required below.

1. No City official or employee or City employee’s immediate family member has an ownership interest in vendor’s company or is deriving personal financial gain from this contract.
2. No retired or separated City official or employee who has been retired or separated from the City for less than one (1) year has an ownership interest in vendor’s Company.
3. No City employee is contemporaneously employed or prospectively to be employed with the vendor.
4. Vendor hereby declares it has not and will not provide gifts or hospitality of any dollar value or any other gratuities to any City employee or elected official to obtain or maintain a contract.
5. Please note any exceptions below:

Conflict of Interest Disclosure*	
Name of City of Ann Arbor employees, elected officials or immediate family members with whom there may be a potential conflict of interest.	<input type="checkbox"/> Relationship to employee <hr/> <input type="checkbox"/> Interest in vendor’s company <input type="checkbox"/> Other (please describe in box below)

*Disclosing a potential conflict of interest does not disqualify vendors. In the event vendors do not disclose potential conflicts of interest and they are detected by the City, vendor will be exempt from doing business with the City.

I certify that this Conflict of Interest Disclosure has been examined by me and that its contents are true and correct to my knowledge and belief and I have the authority to so certify on behalf of the Vendor by my signature below:		
Vendor Name	Vendor Phone Number	
Signature of Vendor Authorized Representative	Date	Printed Name of Vendor Authorized Representative

CITY OF ANN ARBOR NON-DISCRIMINATION ORDINANCE

Relevant provisions of Chapter 112, Nondiscrimination, of the Ann Arbor City Code are included below.
You can review the entire ordinance at www.a2gov.org/humanrights.

Intent: It is the intent of the city that no individual be denied equal protection of the laws; nor shall any individual be denied the enjoyment of his or her civil or political rights or be discriminated against because of actual or perceived age, arrest record, color, disability, educational association, familial status, family responsibilities, gender expression, gender identity, genetic information, height, HIV status, marital status, national origin, political beliefs, race, religion, sex, sexual orientation, source of income, veteran status, victim of domestic violence or stalking, or weight.

Discriminatory Employment Practices: No person shall discriminate in the hire, employment, compensation, work classifications, conditions or terms, promotion or demotion, or termination of employment of any individual. No person shall discriminate in limiting membership, conditions of membership or termination of membership in any labor union or apprenticeship program.

Discriminatory Effects: No person shall adopt, enforce or employ any policy or requirement which has the effect of creating unequal opportunities according to actual or perceived age, arrest record, color, disability, educational association, familial status, family responsibilities, gender expression, gender identity, genetic information, height, HIV status, marital status, national origin, political beliefs, race, religion, sex, sexual orientation, source of income, veteran status, victim of domestic violence or stalking, or weight for an individual to obtain housing, employment or public accommodation, except for a bona fide business necessity. Such a necessity does not arise due to a mere inconvenience or because of suspected objection to such a person by neighbors, customers or other persons.

Nondiscrimination by City Contractors: All contractors proposing to do business with the City of Ann Arbor shall satisfy the contract compliance administrative policy adopted by the City Administrator in accordance with the guidelines of this section. All city contractors shall ensure that applicants are employed and that employees are treated during employment in a manner which provides equal employment opportunity and tends to eliminate inequality based upon any classification protected by this chapter. All contractors shall agree not to discriminate against an employee or applicant for employment with respect to hire, tenure, terms, conditions, or privileges of employment, or a matter directly or indirectly related to employment, because of any applicable protected classification. All contractors shall be required to post a copy of Ann Arbor's Non-Discrimination Ordinance at all work locations where its employees provide services under a contract with the city.

Complaint Procedure: If any individual believes there has been a violation of this chapter, he/she may file a complaint with the City's Human Rights Commission. The complaint must be filed within 180 calendar days from the date of the individual's knowledge of the allegedly discriminatory action or 180 calendar days from the date when the individual should have known of the allegedly discriminatory action. A complaint that is not filed within this timeframe cannot be considered by the Human Rights Commission. To file a complaint, first complete the complaint form, which is available at www.a2gov.org/humanrights. Then submit it to the Human Rights Commission by e-mail (hrc@a2gov.org), by mail (Ann Arbor Human Rights Commission, PO Box 8647, Ann Arbor, MI 48107), or in person (City Clerk's Office). For further information, please call the commission at 734-794-6141 or e-mail the commission at hrc@a2gov.org.

Private Actions For Damages or Injunctive Relief: To the extent allowed by law, an individual who is the victim of discriminatory action in violation of this chapter may bring a civil action for appropriate injunctive relief or damages or both against the person(s) who acted in violation of this chapter.

THIS IS AN OFFICIAL GOVERNMENT NOTICE AND
MUST BE DISPLAYED WHERE EMPLOYEES CAN READILY SEE IT.

