

CITY OF ANN ARBOR
INVITATION TO BID



Riverside Park Asphalt Path Renovations

ITB No. 4586

Due Date: Wednesday, June 12th, 2019 2:00pm (Local Time)

Community Services Area
Parks and Recreation Services
Administering Service Area/Unit

Issued By:

City of Ann Arbor
Procurement Unit
301 E. Huron Street
Ann Arbor, MI 48104

TABLE OF CONTENTS

| | |
|--|---------------|
| TABLE OF CONTENTS..... | TC-1 |
| NOTICE OF PRE-BID CONFERENCE..... | NP-1 |
| INSTRUCTIONS TO BIDDERS..... | IB-1 to 5 |
| INVITATION TO BID..... | ITB-1 to 3 |
| BID FORMS..... | BF-1 to 5 |
| CONTRACT..... | C-1 to 4 |
| BOND FORMS..... | B-1 to 2 |
| GENERAL CONDITIONS..... | GC-1 to 16 |
| STANDARD SPECIFICATIONS..... | SS-17 |
| DETAILED SPECIFICATIONS..... | DS-1 to DS-27 |
| APPENDIX..... | APDX-1 |
| 1. PARK LOCATION MAP | |
| 2. PROJECT SITE PLAN | |
| 3. PROJECT DETAILED SITE PLAN - TO BE PRINTED AT 24X36 | |
| 4. OPTION A SHARED USE PATH DETAIL | |
| 5. OPTION B SHARED USE PATH DETAIL | |
| 6. BENCH DETAIL | |
| 7. PICNIC TABLE DETAIL | |
| 8. CONCRETE PAD/WALK DETAIL | |

ATTACHMENTS

City of Ann Arbor Prevailing Wage Declaration Form
City of Ann Arbor Living Wage Forms
City of Ann Arbor Vendor Conflict of Interest Disclosure Form
City of Ann Arbor Non-Discrimination Ordinance Notice and Declaration Form

NOTICE OF PRE-BID CONFERENCE

A pre-bid conference for this project will be held on **Monday, June 3rd at 11:00am** in the First Floor South Conference Room, **Larcom City Hall, 301 East Huron, Ann Arbor, MI 48104.**

Attendance at this conference is highly recommended. Administrative and technical questions regarding this project will be answered at this time. The pre-bid conference is for information only. Any answers furnished will not be official until verified in writing by the Financial Service Area, Procurement Unit. Answers that change or substantially clarify the bid will be affirmed in an addendum.

INSTRUCTIONS TO BIDDERS

General

Work to be done under this Contract is generally described through the detailed specifications and must be completed fully in accordance with the contract documents. All work to be done under this Contract is located in or near the City of Ann Arbor.

Any Bid which does not conform fully to these instructions may be rejected.

Preparation of Bids

Bids should be prepared providing a straight-forward, concise description of the Bidder's ability to meet the requirements of the ITB. Bids shall be written in ink or typewritten. No erasures are permitted. Mistakes may be crossed out and corrected and must be initialed and dated in ink by the person signing the Bid.

Bids must be submitted on the "Bid Forms" provided with each blank properly filled in. If forms are not fully completed it may disqualify the bid. No alternative bid will be considered unless alternative bids are specifically requested. If alternatives are requested, any deviation from the specification must be fully described, in detail on the "Alternate" section of Bid form.

Each person signing the Bid certifies that he/she is the person in the Bidder's firm/organization responsible for the decision as to the fees being offered in the Bid and has not and will not participated in any action contrary to the terms of this provision.

Questions or Clarifications / Designated City Contacts

All questions regarding this ITB shall be submitted via email. Emailed questions and inquires will be accepted from any and all prospective Bidders in accordance with the terms and conditions of the ITB.

All questions shall be due on or before **Tuesday, June 4th at 5:00pm** and should be addressed as follows:

Specification/Scope of Work questions emailed to Hillary Hanzel at hhanzel@a2gov.org
Bid Process and Compliance questions emailed to Colin Spencer at cspencer@a2gov.org

Any error, omissions or discrepancies in the specification discovered by a prospective contractor and/or service provider shall be brought to the attention of Hillary Hanzel, Park Planner at **hhanzel@a2gov.org** after discovery as possible. Further, the contractor and/or service provide shall not be allowed to take advantage of errors, omissions or discrepancies in the specifications.

Addenda

If it becomes necessary to revise any part of the ITB, notice of the Addendum will be posted to Michigan Inter-governmental Trade Network (MITN) www.mitn.info and/or City of Ann Arbor web site www.A2gov.org for all parties to download.

Each Bidder must in its Bid, to avoid any miscommunications, acknowledge all addenda which it has received, but the failure of a Bidder to receive, or acknowledge receipt of; any addenda shall not relieve the Bidder of the responsibility for complying with the terms thereof.

The City will not be bound by oral responses to inquiries or written responses other than written addenda.

Bid Submission

All Bids are due and must be delivered to the City of Ann Arbor Procurement Unit on or before **Wednesday, June 12th at 2:00pm EST**. Bids submitted late or via oral, telephonic, telegraphic, electronic mail or facsimile **will not** be considered or accepted.

Each Bidder must submit one (1) original Bid and one **(1)** Bid copies in a sealed envelope clearly marked: **ITB No. 4586 Riverside Park Asphalt Path Renovations**.

Bids must be addressed and delivered to:

City of Ann Arbor
Procurement Unit,
c/o Customer Services, 1st Floor
301 East Huron Street
Ann Arbor, MI 48107

All Bids received on or before the Due Date will be publicly opened and recorded immediately. No immediate decisions are rendered.

The following forms provided within this ITB Document must be included in submitted bids.

- **City of Ann Arbor Prevailing Wage Declaration of Compliance**
- **City of Ann Arbor Living Wage Ordinance Declaration of Compliance**
- **Vendor Conflict of Interest Disclosure Form**
- **City of Ann Arbor Non-Discrimination Ordinance Declaration of Compliance**

Bids that fail to provide these completed forms listed above upon bid opening will be rejected as non-responsive and will not be considered for award.

Hand delivered bids will be date/time stamped/signed by the Procurement Unit at the address above in order to be considered. Normal business hours are 9:00 a.m. to 3:00 p.m. Monday through Friday, excluding Holidays. The City will not be liable to any Bidder for any unforeseen circumstances, delivery or postal delays. Postmarking to the Due Date will not substitute for receipt of the Bid. Each Bidder is responsible for submission of their Bid.

Additional time for submission of bids past the stated due date and time will not be granted to a single Bidder; however, additional time may be granted to all Bidders when the City determines in its sole discretion that circumstances warrant it.

Award

The City intends to award a Contract(s) to the lowest responsible Bidder(s). On multi-divisional contracts, separate divisions may be awarded to separate Bidders. The City may also utilize alternatives offered in the Bid Forms, if any, to determine the lowest responsible Bidder on each division, and award multiple divisions to a single Bidder, so that the lowest total cost is achieved for the City. For unit price bids, the Contract will be awarded based upon the unit prices and the lump sum prices stated by the bidder for the work items specified in the bid documents, with consideration given to any alternates selected by the City. If the City determines that the unit price for any item is materially different for the work item bid than either other bidders or the general market, the City, in its sole discretion, in addition to any other right it may have, may reject the bid

as not responsible or non-conforming.

The acceptability of major subcontractors will be considered in determining if a Bidder is responsible. In comparing Bids, the City will give consideration to alternate Bids for items listed in the bid forms. All key staff and subcontractors are subject to the approval by the City.

Official Documents

The City of Ann Arbor officially distributes bid documents from the Procurement Unit or through the Michigan Intergovernmental Trade Network (MITN). Copies of the bid documents obtained from any other source are not Official copies. Addenda and other bid information will only be posted to these official distribution sites. If you obtained City of Ann Arbor Bid documents from other sources, it is recommended that you register on www.MITN.info and obtain an official Bid. Bidders do not need to be shown on the plan holders list provided by MITN to be considered an official plan holder.

Bid Security

Each bid must be accompanied by a certified check, or Bid Bond by a surety licensed and authorized to do business within the State of Michigan, in the amount of 5% of the total of the bid price.

Withdrawal of Bids

After the time of opening, no Bid may be withdrawn for the period of sixty (60) days

Contract Time

Time is of the essence in the performance of the work under this Contract. The available time for work under this Contract is indicated on page C-1, Article III of the Contract. If these time requirements can not be met, the Bidder must stipulate on Bid Form Section 3 - Time Alternate its schedule for performance of the work. Consideration will be given to time in evaluating bids.

Liquidated Damages

A liquidated damages clause, as given on page C-2, Article III of the Contract, provides that the Contractor shall pay the City as liquidated damages, and not as a penalty, a sum certain per day for each and every day that the Contractor may be in default of completion of the specified work, within the time(s) stated in the Contract, or written extensions.

Liquidated damages clauses, as given in the General Conditions, provide further that the City shall be entitled to impose and recover liquidated damages for breach of the obligations under Chapter 112 of the City Code.

The liquidated damages are for the non-quantifiable aspects of any of the previously identified events and do not cover actual damages that can be shown or quantified nor are they intended to preclude recovery of actual damages in addition to the recovery of liquidated damages.

Human Rights Information

All contractors proposing to do business with the City shall satisfy the contract compliance administrative policy adopted by the City Administrator in accordance with the Section 9:158 of the Ann Arbor City Code. Breach of the obligation not to discriminate as outlined in Section 5, beginning at page GC-2 shall be a material breach of the contract. Contractors are required to post a copy of Ann Arbor's Non-Discrimination Ordinance attached at all work locations where its employees provide services under a contract with the City.

Wage Requirements

Section 4, beginning at page GC-1, outlines the requirements for payment of prevailing wages and for payment of a “living wage” to employees providing service to the City under this contract. The successful bidder and its subcontractors must comply with all applicable requirements and provide proof of compliance.

Pursuant to Resolution R-16-469 all public improvement contractors are subject to prevailing wage and will be required to provide to the City payroll records sufficient to demonstrate compliance with the prevailing wage requirements. Use of the Prevailing Wage Form provided in the Appendix section or a City-approved equivalent will be required along with wage rate interviews.

For laborers whose wage level are subject to federal, state and/or local prevailing wage law the appropriate Davis-Bacon wage rate classification is identified based upon the work including within this contract. **The wage determination(s) current on the date 10 days before bids are due shall apply to this contract.** The U.S. Department of Labor (DOL) has provided explanations to assist with classification in the following resource link: www.wdol.gov.

For the purposes of this ITB the Construction Type of Highway will apply.

Conflict Of Interest Disclosure

The City of Ann Arbor Purchasing Policy requires that prospective Vendors complete a Conflict of Interest Disclosure form. A contract may not be awarded to the selected Vendor unless and until the Procurement Unit and the City Administrator have reviewed the Disclosure form and determined that no conflict exists under applicable federal, state, or local law or administrative regulation. Not every relationship or situation disclosed on the Disclosure Form may be a disqualifying conflict. Depending on applicable law and regulations, some contracts may awarded on the recommendation of the City Administrator after full disclosure, where such action is allowed by law, if demonstrated competitive pricing exists and/or it is determined the award is in the best interest of the City. A copy of the Vendor Conflict of Interest Disclosure Form is attached.

Major Subcontractors

The Bidder shall identify on Bid Form Section 4 each major subcontractor it expects to engage for this Contract if the work to be subcontracted is 15% or more of the bid sum or over \$50,000, whichever is less. The Bidder also shall identify the work to be subcontracted to each major subcontractor. The Bidder shall not change or replace a subcontractor without approval by the City.

Debarment

Submission of a Bid in response to this ITB is certification that the Bidder is not currently debarred, suspended, proposed for debarment, and declared ineligible or voluntarily excluded from participation in this transaction by any State or Federal departments or agency. Submission is also agreement that the City will be notified of any changes in this status.

Disclosures

After bids are opened, all information in a submitter’s bid is subjected to disclosure under the provisions of Michigan Public Act No. 442 of 1976, as amended (MCL 15.231 et seq.) known as the “Freedom of Information Act.” The Freedom of Information Act also provides for the complete disclosure of contracts and attachments thereto except where specifically exempted.

Bid Protest

All Bid protests must be in writing and filed with the Purchasing Agent within five (5) business days of the award action. The bidder must clearly state the reasons for the protest. If a bidder contacts a City Service Area/Unit and indicates a desire to protest an award, the Service Area/Unit shall refer the bidder to the Purchasing Agent. The Purchasing Agent will provide the bidder with the appropriate instructions for filing the protest. The protest shall be reviewed by the City Administrator or designee whose decision shall be final.

Any inquiries or requests regarding this procurement should be only submitted in writing to the Designated City Contacts provided herein. Attempts by any prospective bidder to initiate contact with anyone other than the Designated City Contacts provided herein that the bidder believes can influence the procurement decision, e.g., Elected Officials, City Administrator, Selection Committee Members, Appointed Committee Members, etc., may lead to immediate elimination from further consideration.

Cost Liability

The City of Ann Arbor assumes no responsibility or liability for costs incurred by the Bidder prior to the execution of a contract with the City. By submitting a bid, a bidder agrees to bear all costs incurred or related to the preparation, submission and selection process for the bid.

Reservation of Rights

The City of Ann Arbor reserves the right to accept any bid or alternative bid proposed in whole or in part, to reject any or all bids or alternatives bids in whole or in part and to waive irregularity and/or informalities in any bid and to make the award in any manner deemed in the best interest of the City.

Idlefree Ordinance

The City of Ann Arbor adopted an idling reduction Ordinance that goes into effect July 1, 2017. The full text of the ordinance (including exemptions) can be found at: www.a2gov.org/idlefree.

Under the ordinance, No Operator of a Commercial Vehicle shall cause or permit the Commercial Vehicle to Idle:

- (a) For any period of time while the Commercial Vehicle is unoccupied; or
- (b) For more than 5 minutes in any 60-minute period while the Commercial Vehicle is occupied.

In addition, generators and other internal combustion engines are covered

(1) Excluding Motor Vehicle engines, no internal combustion engine shall be operated except when it is providing power or electrical energy to equipment or a tool that is actively in use.

Environmental Commitment

The City of Ann Arbor recognizes its responsibility to minimize negative impacts on human health and the environment while supporting a vibrant community and economy. The City further recognizes that the products and services the City buys have inherent environmental and economic impacts and that the City should make procurement decisions that embody, promote, and encourage the City's commitment to the environment.

The City encourages potential vendors to bring forward emerging and progressive products and services that are best suited to the City's environmental principles.

INVITATION TO BID

City of Ann Arbor
Guy C. Larcom Municipal Building
Ann Arbor, Michigan 48107

Ladies and Gentlemen:

The undersigned, as Bidder, declares that this Bid is made in good faith, without fraud or collusion with any person or persons bidding on the same Contract; that this Bidder has carefully read and examined the bid documents, including City Nondiscrimination requirements and Declaration of Compliance Form, Living Wage requirements and Declaration of Compliance Form, Prevailing Wage requirements and Declaration of Compliance Form, Vendor Conflict of Interest Form, Notice of Pre-Bid Conference, Instructions to Bidders, Bid, Bid Forms, Contract, Bond Forms, General Conditions, Standard Specifications, Detailed Specifications, all Addenda, and the Plans (if applicable) and understands them. The Bidder declares that it conducted a full investigation at the site and of the work proposed and is fully informed as to the nature of the work and the conditions relating to the work's performance. The Bidder also declares that it has extensive experience in successfully completing projects similar to this one.

The Bidder acknowledges that it has not received or relied upon any representations or warrants of any nature whatsoever from the City of Ann Arbor, its agents or employees, and that this Bid is based solely upon the Bidder's own independent business judgment.

The undersigned proposes to perform all work shown on the plans or described in the bid documents, including any addenda issued, and to furnish all necessary machinery, tools, apparatus, and other means of construction to do all the work, furnish all the materials, and complete the work in strict accordance with all terms of the Contract of which this Bid is one part.

In accordance with these bid documents, and Addenda numbered _____, the undersigned, as Bidder, proposes to perform at the sites in and/or around Ann Arbor, Michigan, all the work included herein for the amounts set forth in the Bid Forms.

The Bidder declares that it has become fully familiar with the liquidated damage clauses for completion times and for compliance with City Code Chapter 112, understands and agrees that the liquidated damages are for the non-quantifiable aspects of non-compliance and do not cover actual damages that may be shown and agrees that if awarded the Contract, all liquidated damage clauses form part of the Contract.

The Bidder declares that it has become fully familiar with the provisions of Chapter 14, Section 1:320 (Prevailing wages) and Chapter 23 (Living Wage) of the Code of the City of Ann Arbor and that it understands and agrees to comply, to the extent applicable to employees providing services to the City under this Contract, with the wage and reporting requirements stated in the City Code provisions cited. Bidder certifies that the statements contained in the City Prevailing Wage and Living Wage Declaration of Compliance Forms are true and correct. Bidder further agrees that the cited provisions of Chapter 14 and Chapter 23 form a part of this Contract.

The Bidder declares that it has become familiar with the City Conflict of Interest Disclosure Form and certifies that the statement contained therein is true and correct.

The Bidder encloses a certified check or Bid Bond in the amount of 5% of the total of the Bid Price. The Bidder agrees both to contract for the work and to furnish the necessary Bonds and insurance documentation within 10 days after being notified of the acceptance of the Bid.

If this Bid is accepted by the City and the Bidder fails to contract and furnish the required Bonds and insurance documentation within 10 days after being notified of the acceptance of this Bid, then the Bidder shall be considered to have abandoned the Contract and the certified check or Bid Bond accompanying this Bid shall become due and payable to the City.

If the Bidder enters into the Contract in accordance with this Bid, or if this Bid is rejected, then the accompanying check or Bid Bond shall be returned to the Bidder.

In submitting this Bid, it is understood that the right is reserved by the City to accept any Bid, to reject any or all Bids, to waive irregularities and/or informalities in any Bid, and to make the award in any manner the City believes to be in its best interest.

SIGNED THIS _____ DAY OF _____, 201_.

Bidder's Name

Authorized Signature of Bidder

Official Address

(Print Name of Signer Above)

Telephone Number

Email Address for Award Notice

LEGAL STATUS OF BIDDER

(The Bidder shall fill out the appropriate form and strike out the other three.)

Bidder declares that it is:

* A corporation organized and doing business under the laws of the State of _____, for whom _____, bearing the office title of _____, whose signature is affixed to this Bid, is authorized to execute contracts.

NOTE: If not incorporated in Michigan, please attach the corporation's Certificate of Authority

• A limited liability company doing business under the laws of the State of _____, whom _____ bearing the title of _____ whose signature is affixed to this proposal, is authorized to execute contract on behalf of the LLC.

* A partnership, organized under the laws of the state of _____ and filed in the county of _____, whose members are (list all members and the street and mailing address of each) (attach separate sheet if necessary):

* An individual, whose signature with address, is affixed to this Bid: _____ (initial here)

Authorized Official

_____ **Date** _____, 201__

(Print) Name _____ Title _____

Company: _____

Address: _____

Contact Phone () _____ Fax () _____

Email _____

BID FORM

Section 1 – Schedule of Prices

Company: _____

Project: **Riverside Park Path Renovations, ITB # 4586**

Unit Price Bid –

Notes:

1. Bidders are encouraged to but not required to submit bids for both options (Bid Options A through B).
2. All bidders shall fully complete the bid table and provide a Unit Price and Total Price for the bid options(s) they are submitting bids on.
3. Quantities included in the bid table represent estimated quantities for different work. The CONTRACTOR shall be compensated for the actual number of items completed using the unit prices provided.
4. The Owner, at its sole discretion, may elect to delete any portion of the work delineated below, with no change to the unit prices provided. Work shall be determined based upon the availability of funds.
5. Any item not provided in the following list shall be considered incidental to the Contract.
6. Contract shall be awarded based on the base bid or any combination of the base bid and alternate bid areas in any manner the City believes to be in its best interest.

PATH RENOVATION OPTION A BID ITEMS

The Bidder agrees to complete the Project and all related work, as specified for the following unit prices.

| BID OPTION A: PULVERIZE EXISTING HMA IN PLACE AND INSTALL NEW HMA PATH | | | | | |
|---|---|---------------------------|-------------|-------------------|--------------------|
| Item | Item Description | Estimated Quantity | Unit | Unit Price | Total Price |
| 1. | General Conditions, Mobilization, Bonds, Insurance, Permits | 1 | LS | \$ | \$ |
| 2. | Install temporary path closure fencing and tree protection fencing. | 1 | LS | \$ | \$ |
| 3. | Installation and management of all Soil Erosion and Sedimentation Control measures | 1 | LS | \$ | \$ |
| 4. | Full removal of vegetation, roots, and stumps along areas to accommodate proposed work | 1 | LS | \$ | \$ |
| 5. | Removal of existing benches, picnic tables, posts and concrete pads per plan | 1 | LS | \$ | \$ |
| 6. | Pulverization of existing asphalt path surfacing (approximately 9' wide), grading and compaction for use as base aggregate. Final milling product should be no greater than 1 ½" in diameter. Prepare and compact existing subbase of path alignment, installation of milling material to 6" depth, load, haul, place, and compact in place | 1,700 | LF | \$ | \$ |
| 7. | Excavation of existing soils and grading to widen path to 10' wide HMA and 12' wide base aggregate. Excavated materials to be removed from site and lawfully disposed. | 600 | SY | \$ | \$ |
| 8. | Limestone for widening pathway base to 12' – 21AA, 6" depth. (Expanding path base by 3') | 600 | SY | \$ | \$ |
| 9. | Bituminous Hot Mix Asphalt Leveling course – LVSP | 220 | TON | \$ | \$ |
| 10. | Bituminous Hot Mix Asphalt Wearing course – 5E1 | 220 | TON | \$ | \$ |
| 11. | Provide and install three (3) picnic tables and four (4) benches with concrete pads per standard details. Locations to be determined in field by supervising professional. | 1 | LS | \$ | \$ |
| 12. | Restoration, topsoil, seed and mulch all disturbed areas. Site Clean-up for entire project. | 1 | LS | \$ | \$ |
| 13. | Certified payroll compliance & reporting | 1 | LS | \$ | \$ |
| Estimated Total Bid Amount (Items 1 through 13) | | | | | \$ |

PATH RENOVATION OPTION B BID ITEMS

The Bidder agrees to complete the Project and all related work, as specified for the following unit prices.

| BID OPTION B: INSTALL NEW HMA PATH AND NEW PATH BASE | | | | | |
|---|--|---------------------------|-------------|-------------------|--------------------|
| Item | Item Description | Estimated Quantity | Unit | Unit Price | Total Price |
| 1. | General Conditions, Mobilization, Bonds, Insurance, Permits | 1 | LS | \$ | \$ |
| 2. | Install temporary path closure fencing and tree protection fencing | 1 | LS | \$ | \$ |
| 3. | Installation and management of all Soil Erosion and Sedimentation Control measures | 1 | LS | \$ | \$ |
| 4. | Full removal of vegetation, roots, and stumps along areas to accommodate proposed work | 1 | LS | \$ | \$ |
| 5. | Removal of existing benches, picnic tables, posts and concrete pads per plan | 1 | LS | \$ | \$ |
| 6. | Demolition, removal, and lawful disposal of all existing asphalt paths – approximately 9' wide. | 1,700 | LF | \$ | \$ |
| 7. | Excavation, loading, hauling, and grading of existing soils to accommodate proposed 12' wide base aggregate for path. Excavated materials to be removed from site and lawfully disposed. | 2,400 | SY | \$ | \$ |
| 8. | Structural Geogrid placed below limestone base | 2,400 | SY | \$ | \$ |
| 9. | Limestone for pathway base – 21AA, 6" depth | 2,400 | SY | \$ | \$ |
| 10. | Bituminous Hot Mix Asphalt Leveling course – LVSP | 220 | TON | \$ | \$ |
| 11. | Bituminous Hot Mix Asphalt Wearing course – 5E1 | 220 | TON | \$ | \$ |
| 12. | Undercut allowance – geotextile and 21AA Limestone compacted | 250 | CY | \$ | \$ |
| 13. | Undercut allowance – geotextile and 6A Limestone compacted | 250 | CY | \$ | \$ |
| 14. | Provide and install three (3) picnic tables and four (4) benches with concrete pads per standard details. Locations to be determined in field by supervising professional. | 1 | LS | \$ | \$ |
| 15. | Restoration, topsoil, seed and mulch all disturbed areas; Site Clean-up for entire project. | 1 | LS | \$ | \$ |
| 16. | Certified payroll compliance & reporting | 1 | LS | \$ | \$ |
| Estimated Total Bid Amount (Items 1 through 16) | | | | | \$ |

BID FORM

Section 2 – Material, Equipment and Environmental Alternates

The Base Bid proposal price shall include materials and equipment selected from the designated items and manufacturers listed in the bidding documents. This is done to establish uniformity in bidding and to establish standards of quality for the items named.

If the Contractor wishes to quote alternate items for consideration by the City, it may do so under this Section. A complete description of the item and the proposed price differential must be provided. Unless approved at the time of award, substitutions where items are specifically named will be considered only as a negotiated change in Contract Sum.

If an environmental alternative is bid the City strongly encourages bidders to provide recent examples of product testing and previous successful use for the City to properly evaluate the environmental alternative. Testing data from independent accredited organizations are strongly preferred.

| <u>Item Number</u> | <u>Description</u> | <u>Add/Deduct Amount</u> |
|--------------------|--------------------|--------------------------|
|--------------------|--------------------|--------------------------|

If the Bidder does not suggest any material or equipment alternate, the Bidder **MUST** complete the following statement:

For the work outlined in this request for bid, the bidder does NOT propose any material or equipment alternate under the Contract.

Signature of Authorized Representative of Bidder _____ Date _____

BID FORM

Section 3 - Time Alternate

If the Bidder takes exception to the time stipulated in Article III of the Contract, Time of Completion, page C-2, it is requested to stipulate below its proposed time for performance of the work. Consideration will be given to time in evaluating bids.

If the Bidder does not suggest any time alternate, the Bidder **MUST** complete the following statement:

For the work outlined in this request for bid, the bidder does NOT propose any time alternate under the Contract.

Signature of Authorized Representative of Bidder _____ Date _____

BID FORM

Section 4 - Major Subcontractors

For purposes of this Contract, a Subcontractor is anyone (other than the Contractor) who performs work (other than or in addition to the furnishing of materials, plans or equipment) at or about the construction site, directly or indirectly for or on behalf of the Contractor (and whether or not in privity of Contract with the Contractor), but shall not include any individual who furnishes merely the individual's own personal labor or services.

Contractor agrees that all subcontracts entered into by the Contractor shall contain similar wage provision to Section 4 of the General Conditions covering subcontractor's employees who perform work on this contract.

For the work outlined in these documents the Bidder expects to engage the following major subcontractors to perform the work identified:

| <u>Subcontractor (Name and Address)</u> | <u>Work</u> | <u>Amount</u> |
|---|-------------|---------------|
|---|-------------|---------------|

If the Bidder does not expect to engage any major subcontractor, the Bidder **MUST** complete the following statement:

For the work outlined in this request for bid, the bidder does NOT expect to engage any major subcontractor to perform work under the Contract.

Signature of Authorized Representative of Bidder _____ Date _____

BID FORM

Section 5 – References

Include a minimum of ___ reference from similar project completed within the past ____ years.

[Refer also to Instructions to Bidders for additional requirements, if any]

1) _____
Project Name Cost Date Constructed

_____ Phone Number
Contact Name

2) _____
Project Name Cost Date Constructed

_____ Phone Number
Contact Name

3) _____
Project Name Cost Date Constructed

_____ Phone Number
Contact Name

SAMPLE STANDARD CONTRACT

If a contract is awarded, the selected contractor will be required to adhere to a set of general contract provisions which will become a part of any formal agreement. These provisions are general principles which apply to all contractors of service to the City of Ann Arbor such as the following:

CONTRACT

THIS AGREEMENT is made on the _____ day of _____, 201_, between the CITY OF ANN ARBOR, a Michigan Municipal Corporation, 301 East Huron Street, Ann Arbor, Michigan 48104 ("City") and _____ ("Contractor")

(An individual/partnership/corporation, include state of incorporation)

(Address)

Based upon the mutual promises below, the Contractor and the City agree as follows:

ARTICLE I - Scope of Work

The Contractor agrees to furnish all of the materials, equipment and labor necessary; and to abide by all the duties and responsibilities applicable to it for the project titled [Insert Title of Bid and Bid Number] in accordance with the requirements and provisions of the following documents, including all written modifications incorporated into any of the documents, which are incorporated as part of this Contract:

Non-discrimination and Living Wage
Declaration of Compliance Forms (if
applicable)
Vendor Conflict of Interest Form
Prevailing Wage Declaration of
Compliance Form (if applicable)
Bid Forms
Contract and Exhibits
Bonds

General Conditions
Standard Specifications
Detailed Specifications
Plans
Addenda

ARTICLE II - Definitions

Administering Service Area/Unit means **Community Services Area / Parks and Recreation Services**

Project means **Riverside Park Asphalt Path Renovations, ITB#4586**

ARTICLE III - Time of Completion

- (A) The work to be completed under this Contract shall begin immediately on the date specified in the Notice to Proceed issued by the City.
- (B) If Option A is selected, the work must be completed by October 15th. If Option B is selected, the work must be completed by November 1st. The entire work for this Contract shall be completed within Thirty (45) consecutive calendar days.
- (C) Failure to complete all the work within the time specified above, including any extension granted in writing by the Supervising Professional, shall obligate the

Contractor to pay the City, as liquidated damages and not as a penalty, an amount equal to \$500 for each calendar day of delay in the completion of all the work. If any liquidated damages are unpaid by the Contractor, the City shall be entitled to deduct these unpaid liquidated damages from the monies due the Contractor.

The liquidated damages are for the non-quantifiable aspects of any of the previously identified events and do not cover actual damages that can be shown or quantified nor are they intended to preclude recovery of actual damages in addition to the recovery of liquidated damages.

ARTICLE IV - The Contract Sum

- (A) The City shall pay to the Contractor for the performance of the Contract, the unit prices as given in the Bid Form for the estimated bid total of:

_____ Dollars (\$_____)

- (B) The amount paid shall be equitably adjusted to cover changes in the work ordered by the Supervising Professional but not required by the Contract Documents. Increases or decreases shall be determined only by written agreement between the City and Contractor.

ARTICLE V - Assignment

This Contract may not be assigned or subcontracted any portion of any right or obligation under this contract without the written consent of the City. Notwithstanding any consent by the City to any assignment, Contractor shall at all times remain bound to all warranties, certifications, indemnifications, promises and performances, however described, as are required of it under this contract unless specifically released from the requirement, in writing, by the City.

ARTICLE VI - Choice of Law

This Contract shall be construed, governed, and enforced in accordance with the laws of the State of Michigan. By executing this agreement, the Contractor and the City agree to venue in a court of appropriate jurisdiction sitting within Washtenaw County for purposes of any action arising under this Contract. The parties stipulate that the venue referenced in this Contract is for convenience and waive any claim of non-convenience.

Whenever possible, each provision of the Contract will be interpreted in a manner as to be effective and valid under applicable law. The prohibition or invalidity, under applicable law, of any provision will not invalidate the remainder of the Contract.

ARTICLE VII - Relationship of the Parties

The parties of the Contract agree that it is not a Contract of employment but is a Contract to accomplish a specific result. Contractor is an independent Contractor performing services for the City. Nothing contained in this Contract shall be deemed to constitute any other relationship between the City and the Contractor.

Contractor certifies that it has no personal or financial interest in the project other than the compensation it is to receive under the Contract. Contractor certifies that it is not, and shall not become, overdue or in default to the City for any Contract, debt, or any other obligation to the City

including real or personal property taxes. City shall have the right to set off any such debt against compensation awarded for services under this agreement.

ARTICLE VIII - Notice

All notices given under this Contract shall be in writing, and shall be by personal delivery or by certified mail with return receipt requested to the parties at their respective addresses as specified in the Contract Documents or other address the Contractor may specify in writing. Notice will be deemed given on the date when one of the following first occur: (1) the date of actual receipt; or (2) three days after mailing certified U.S. mail.

ARTICLE IX - Indemnification

To the fullest extent permitted by law, Contractor shall indemnify, defend and hold harmless the City, its officers, employees and agents harmless from all suits, claims, judgments and expenses including attorney’s fees resulting or alleged to result, in whole or in part, from any act or omission, which is in any way connected or associated with this Contract, by the Contractor or anyone acting on the Contractor’s behalf under this Contract. Contractor shall not be responsible to indemnify the City for losses or damages caused by or resulting from the City’s sole negligence. The provisions of this Article shall survive the expiration or earlier termination of this contract for any reason.

ARTICLE X - Entire Agreement

This Contract represents the entire understanding between the City and the Contractor and it supersedes all prior representations, negotiations, agreements, or understandings whether written or oral. Neither party has relied on any prior representations in entering into this Contract. No terms or conditions of either party’s invoice, purchase order or other administrative document shall modify the terms and conditions of this Contract, regardless of the other party’s failure to object to such form. This Contract shall be binding on and shall inure to the benefit of the parties to this Contract and their permitted successors and permitted assigns and nothing in this Contract, express or implied, is intended to or shall confer on any other person or entity any legal or equitable right, benefit, or remedy of any nature whatsoever under or by reason of this Contract. This Contract may be altered, amended or modified only by written amendment signed by the City and the Contractor.

FOR CONTRACTOR

By _____

Its: _____

FOR THE CITY OF ANN ARBOR

By _____
Christopher Taylor, Mayor

By _____
Jacqueline Beaudry, City Clerk

Approved as to substance

By _____
City Administrator

By _____

Services Area Administrator

Approved as to form and content

Stephen K. Postema, City Attorney

PERFORMANCE BOND

- (1) _____ of _____ (referred to as "Principal"), and _____, a corporation duly authorized to do business in the State of Michigan (referred to as "Surety"), are bound to the City of Ann Arbor, Michigan (referred to as "City"), for \$ _____, the payment of which Principal and Surety bind themselves, their heirs, executors, administrators, successors and assigns, jointly and severally, by this bond.
- (2) The Principal has entered a written Contract with the City dated _____, 201_, for: _____ and this bond is given for that Contract in compliance with Act No. 213 of the Michigan Public Acts of 1963, as amended, being MCL 129.201 et seq.
- (3) Whenever the Principal is declared by the City to be in default under the Contract, the Surety may promptly remedy the default or shall promptly:
- (a) complete the Contract in accordance with its terms and conditions; or
 - (b) obtain a bid or bids for submission to the City for completing the Contract in accordance with its terms and conditions, and upon determination by Surety of the lowest responsible bidder, arrange for a Contract between such bidder and the City, and make available, as work progresses, sufficient funds to pay the cost of completion less the balance of the Contract price; but not exceeding, including other costs and damages for which Surety may be liable hereunder, the amount set forth in paragraph 1.
- (4) Surety shall have no obligation to the City if the Principal fully and promptly performs under the Contract.
- (5) Surety agrees that no change, extension of time, alteration or addition to the terms of the Contract or to the work to be performed thereunder, or the specifications accompanying it shall in any way affect its obligations on this bond, and waives notice of any such change, extension of time, alteration or addition to the terms of the Contract or to the work, or to the specifications.

SIGNED AND SEALED this _____ day of _____, 201_.

(Name of Surety Company)

By _____
(Signature)

Its _____
(Title of Office)

Approved as to form:

Stephen K. Postema, City Attorney

(Name of Principal)

By _____
(Signature)

Its _____
(Title of Office)

Name and address of agent:

LABOR AND MATERIAL BOND

- (1) _____
of _____ (referred to as "Principal"), and _____, a corporation duly authorized to do business in the State of Michigan, (referred to as "Surety"), are bound to the City of Ann Arbor, Michigan (referred to as "City"), for the use and benefit of claimants as defined in Act 213 of Michigan Public Acts of 1963, as amended, being MCL 129.201 et seq., in the amount of \$ _____, for the payment of which Principal and Surety bind themselves, their heirs, executors, administrators, successors and assigns, jointly and severally, by this bond.
- (2) The Principal has entered a written Contract with the City, dated _____, 201_, for _____; and this bond is given for that Contract in compliance with Act No. 213 of the Michigan Public Acts of 1963 as amended;
- (3) If the Principal fails to promptly and fully repay claimants for labor and material reasonably required under the Contract, the Surety shall pay those claimants.
- (4) Surety's obligations shall not exceed the amount stated in paragraph 1, and Surety shall have no obligation if the Principal promptly and fully pays the claimants.

SIGNED AND SEALED this _____ day of _____, 201_

(Name of Surety Company)

By _____
(Signature)

Its _____
(Title of Office)

Approved as to form:

Stephen K. Postema, City Attorney

(Name of Principal)

By _____
(Signature)

Its _____
(Title of Office)

Name and address of agent:

GENERAL CONDITIONS

Section 1 - Execution, Correlation and Intent of Documents

The contract documents shall be signed in 2 copies by the City and the Contractor.

The contract documents are complementary and what is called for by any one shall be binding. The intention of the documents is to include all labor and materials, equipment and transportation necessary for the proper execution of the work. Materials or work described in words which so applied have a well-known technical or trade meaning have the meaning of those recognized standards.

In case of a conflict among the contract documents listed below in any requirement(s), the requirement(s) of the document listed first shall prevail over any conflicting requirement(s) of a document listed later.

(1) Addenda in reverse chronological order; (2) Detailed Specifications; (3) Standard Specifications; (4) Plans; (5) General Conditions; (6) Contract; (7) Bid Forms; (8) Bond Forms; (9) Bid.

Section 2 - Order of Completion

The Contractor shall submit with each invoice, and at other times reasonably requested by the Supervising Professional, schedules showing the order in which the Contractor proposes to carry on the work. They shall include the dates at which the Contractor will start the several parts of the work, the estimated dates of completion of the several parts, and important milestones within the several parts.

Section 3 - Familiarity with Work

The Bidder or its representative shall make personal investigations of the site of the work and of existing structures and shall determine to its own satisfaction the conditions to be encountered, the nature of the ground, the difficulties involved, and all other factors affecting the work proposed under this Contract. The Bidder to whom this Contract is awarded will not be entitled to any additional compensation unless conditions are clearly different from those which could reasonably have been anticipated by a person making diligent and thorough investigation of the site.

The Bidder shall immediately notify the City upon discovery, and in every case prior to submitting its Bid, of every error or omission in the bidding documents that would be identified by a reasonably competent, diligent Bidder. In no case will a Bidder be allowed the benefit of extra compensation or time to complete the work under this Contract for extra expenses or time spent as a result of the error or omission.

Section 4 - Wage Requirements

Under this Contract, the Contractor shall conform to Chapter 14 of Title I of the Code of the City of Ann Arbor as amended; which in part states "...that all craftsmen, mechanics and laborers employed directly on the site in connection with said improvements, including said employees of subcontractors, shall receive the prevailing wage for the corresponding classes of craftsmen,

mechanics and laborers, as determined by statistics for the Ann Arbor area compiled by the United States Department of Labor. At the request of the City, any contractor or subcontractor shall provide satisfactory proof of compliance with the contract provisions required by the Section.

Pursuant to Resolution R-16-469 all public improvement contractors are subject to prevailing wage and will be required to provide to the City payroll records sufficient to demonstrate compliance with the prevailing wage requirements. A sample Prevailing Wage Form is provided in the Appendix herein for reference as to what will be expected from contractors. Use of the Prevailing Wage Form provided in the Appendix section or a City-approved equivalent will be required along with wage rate interviews.

Where the Contract and the Ann Arbor City Ordinance are silent as to definitions of terms required in determining contract compliance with regard to prevailing wages, the definitions provided in the Davis-Bacon Act as amended (40 U.S.C. 278-a to 276-a-7) for the terms shall be used.

If the Contractor is a "covered employer" as defined in Chapter 23 of the Ann Arbor City Code, the Contractor agrees to comply with the living wage provisions of Chapter 23 of the Ann Arbor City Code. The Contractor agrees to pay those employees providing Services to the City under this Agreement a "living wage," as defined in Section 1:815 of the Ann Arbor City Code, as adjusted in accordance with Section 1:815(3); to post a notice approved by the City of the applicability of Chapter 23 in every location in which regular or contract employees providing services under this Agreement are working; to maintain records of compliance; if requested by the City, to provide documentation to verify compliance; to take no action that would reduce the compensation, wages, fringe benefits, or leave available to any employee or person contracted for employment in order to pay the living wage required by Section 1:815; and otherwise to comply with the requirements of Chapter 23.

Contractor agrees that all subcontracts entered into by the Contractor shall contain similar wage provision covering subcontractor's employees who perform work on this contract.

Section 5 - Non-Discrimination

The Contractor agrees to comply, and to require its subcontractor(s) to comply, with the nondiscrimination provisions of MCL 37.2209. The Contractor further agrees to comply with the provisions of Section 9:158 of Chapter 112 of Title IX of the Ann Arbor City Code, and to assure that applicants are employed and that employees are treated during employment in a manner which provides equal employment opportunity.

Section 6 - Materials, Appliances, Employees

Unless otherwise stipulated, the Contractor shall provide and pay for all materials, labor, water, tools, equipment, light, power, transportation, and other facilities necessary or used for the execution and completion of the work. Unless otherwise specified, all materials incorporated in the permanent work shall be new, and both workmanship and materials shall be of the highest quality. The Contractor shall, if required, furnish satisfactory evidence as to the kind and quality of materials.

The Contractor shall at all times enforce strict discipline and good order among its employees, and shall seek to avoid employing on the work any unfit person or anyone not skilled in the work assigned.

Adequate sanitary facilities shall be provided by the Contractor.

Section 7 - Qualifications for Employment

The Contractor shall employ competent laborers and mechanics for the work under this Contract. For work performed under this Contract, employment preference shall be given to qualified local residents.

Section 8 - Royalties and Patents

The Contractor shall pay all royalties and license fees. It shall defend all suits or claims for infringements of any patent rights and shall hold the City harmless from loss on account of infringement except that the City shall be responsible for all infringement loss when a particular process or the product of a particular manufacturer or manufacturers is specified, unless the City has notified the Contractor prior to the signing of the Contract that the particular process or product is patented or is believed to be patented.

Section 9 - Permits and Regulations

The Contractor must secure and pay for all permits, permit or plan review fees and licenses necessary for the prosecution of the work. These include but are not limited to City building permits, right-of-way permits, lane closure permits, right-of-way occupancy permits, and the like. The City shall secure and pay for easements shown on the plans unless otherwise specified.

The Contractor shall give all notices and comply with all laws, ordinances, rules and regulations bearing on the conduct of the work as drawn and specified. If the Contractor observes that the contract documents are at variance with those requirements, it shall promptly notify the Supervising Professional in writing, and any necessary changes shall be adjusted as provided in the Contract for changes in the work.

Section 10 - Protection of the Public and of Work and Property

The Contractor is responsible for the means, methods, sequences, techniques and procedures of construction and safety programs associated with the work contemplated by this contract. The Contractor, its agents or sub-contractors, shall comply with the "General Rules and Regulations for the Construction Industry" as published by the Construction Safety Commission of the State of Michigan and to all other local, State and National laws, ordinances, rules and regulations pertaining to safety of persons and property.

The Contractor shall take all necessary and reasonable precautions to protect the safety of the public. It shall continuously maintain adequate protection of all work from damage, and shall take all necessary and reasonable precautions to adequately protect all public and private property from injury or loss arising in connection with this Contract. It shall make good any damage, injury or loss to its work and to public and private property resulting from lack of reasonable protective precautions, except as may be due to errors in the contract documents, or caused by agents or employees of the City. The Contractor shall obtain and maintain sufficient insurance to cover damage to any City property at the site by any cause.

In an emergency affecting the safety of life, or the work, or of adjoining property, the Contractor is, without special instructions or authorization from the Supervising Professional, permitted to act at its discretion to prevent the threatened loss or injury. It shall also so act, without appeal, if authorized or instructed by the Supervising Professional.

Any compensation claimed by the Contractor for emergency work shall be determined by agreement or in accordance with the terms of Claims for Extra Cost - Section 15.

Section 11 - Inspection of Work

The City shall provide sufficient competent personnel for the inspection of the work.

The Supervising Professional shall at all times have access to the work whenever it is in preparation or progress, and the Contractor shall provide proper facilities for access and for inspection.

If the specifications, the Supervising Professional's instructions, laws, ordinances, or any public authority require any work to be specially tested or approved, the Contractor shall give the Supervising Professional timely notice of its readiness for inspection, and if the inspection is by an authority other than the Supervising Professional, of the date fixed for the inspection. Inspections by the Supervising Professional shall be made promptly, and where practicable at the source of supply. If any work should be covered up without approval or consent of the Supervising Professional, it must, if required by the Supervising Professional, be uncovered for examination and properly restored at the Contractor's expense.

Re-examination of any work may be ordered by the Supervising Professional, and, if so ordered, the work must be uncovered by the Contractor. If the work is found to be in accordance with the contract documents, the City shall pay the cost of re-examination and replacement. If the work is not in accordance with the contract documents, the Contractor shall pay the cost.

Section 12 - Superintendence

The Contractor shall keep on the work site, during its progress, a competent superintendent and any necessary assistants, all satisfactory to the Supervising Professional. The superintendent will be responsible to perform all on-site project management for the Contractor. The superintendent shall be experienced in the work required for this Contract. The superintendent shall represent the Contractor and all direction given to the superintendent shall be binding as if given to the Contractor. Important directions shall immediately be confirmed in writing to the Contractor. Other directions will be confirmed on written request. The Contractor shall give efficient superintendence to the work, using its best skill and attention.

Section 13 - Changes in the Work

The City may make changes to the quantities of work within the general scope of the Contract at any time by a written order and without notice to the sureties. If the changes add to or deduct from the extent of the work, the Contract Sum shall be adjusted accordingly. All the changes shall be executed under the conditions of the original Contract except that any claim for extension of time caused by the change shall be adjusted at the time of ordering the change.

In giving instructions, the Supervising Professional shall have authority to make minor changes in the work not involving extra cost and not inconsistent with the purposes of the work, but otherwise, except in an emergency endangering life or property, no extra work or change shall be made unless in pursuance of a written order by the Supervising Professional, and no claim for an addition to the Contract Sum shall be valid unless the additional work was ordered in writing.

The Contractor shall proceed with the work as changed and the value of the work shall be determined as provided in Claims for Extra Cost - Section 15.

Section 14 - Extension of Time

Extension of time stipulated in the Contract for completion of the work will be made if and as the

Supervising Professional may deem proper under any of the following circumstances:

- (1) When work under an extra work order is added to the work under this Contract;
- (2) When the work is suspended as provided in Section 20;
- (3) When the work of the Contractor is delayed on account of conditions which could not have been foreseen, or which were beyond the control of the Contractor, and which were not the result of its fault or negligence;
- (4) Delays in the progress of the work caused by any act or neglect of the City or of its employees or by other Contractors employed by the City;
- (5) Delay due to an act of Government;
- (6) Delay by the Supervising Professional in the furnishing of plans and necessary information;
- (7) Other cause which in the opinion of the Supervising Professional entitles the Contractor to an extension of time.

The Contractor shall notify the Supervising Professional within 7 days of an occurrence or conditions which, in the Contractor's opinion, entitle it to an extension of time. The notice shall be in writing and submitted in ample time to permit full investigation and evaluation of the Contractor's claim. The Supervising Professional shall acknowledge receipt of the Contractor's notice within 7 days of its receipt. Failure to timely provide the written notice shall constitute a waiver by the Contractor of any claim.

In situations where an extension of time in contract completion is appropriate under this or any other section of the contract, the Contractor understands and agrees that the only available adjustment for events that cause any delays in contract completion shall be extension of the required time for contract completion and that there shall be no adjustments in the money due the Contractor on account of the delay.

Section 15 - Claims for Extra Cost

If the Contractor claims that any instructions by drawings or other media issued after the date of the Contract involved extra cost under this Contract, it shall give the Supervising Professional written notice within 7 days after the receipt of the instructions, and in any event before proceeding to execute the work, except in emergency endangering life or property. The procedure shall then be as provided for Changes in the Work-Section 13. No claim shall be valid unless so made.

If the Supervising Professional orders, in writing, the performance of any work not covered by the contract documents, and for which no item of work is provided in the Contract, and for which no unit price or lump sum basis can be agreed upon, then the extra work shall be done on a Cost-Plus-Percentage basis of payment as follows:

- (1) The Contractor shall be reimbursed for all reasonable costs incurred in doing the work, and shall receive an additional payment of 15% of all the reasonable costs to cover both its indirect overhead costs and profit;
- (2) The term "Cost" shall cover all payroll charges for employees and supervision required under the specific order, together with all worker's compensation, Social Security, pension and retirement allowances and social insurance, or other regular payroll charges on same;

the cost of all material and supplies required of either temporary or permanent character; rental of all power-driven equipment at agreed upon rates, together with cost of fuel and supply charges for the equipment; and any costs incurred by the Contractor as a direct result of executing the order, if approved by the Supervising Professional;

- (3) If the extra is performed under subcontract, the subcontractor shall be allowed to compute its charges as described above. The Contractor shall be permitted to add an additional charge of 5% percent to that of the subcontractor for the Contractor's supervision and contractual responsibility;
- (4) The quantities and items of work done each day shall be submitted to the Supervising Professional in a satisfactory form on the succeeding day, and shall be approved by the Supervising Professional and the Contractor or adjusted at once;
- (5) Payments of all charges for work under this Section in any one month shall be made along with normal progress payments. Retainage shall be in accordance with Progress Payments-Section 16.

No additional compensation will be provided for additional equipment, materials, personnel, overtime or special charges required to perform the work within the time requirements of the Contract.

When extra work is required and no suitable price for machinery and equipment can be determined in accordance with this Section, the hourly rate paid shall be 1/40 of the basic weekly rate listed in the Rental Rate Blue Book published by Dataquest Incorporated and applicable to the time period the equipment was first used for the extra work. The hourly rate will be deemed to include all costs of operation such as bucket or blade, fuel, maintenance, "regional factors", insurance, taxes, and the like, but not the costs of the operator.

Section 16 - Progress Payments

The Contractor shall submit each month, or at longer intervals, if it so desires, an invoice covering work performed for which it believes payment, under the Contract terms, is due. The submission shall be to the City's Finance Department - Accounting Division. The Supervising Professional will, within 10 days following submission of the invoice, prepare a certificate for payment for the work in an amount to be determined by the Supervising Professional as fairly representing the acceptable work performed during the period covered by the Contractor's invoice. To insure the proper performance of this Contract, the City will retain a percentage of the estimate in accordance with Act 524, Public Acts of 1980. The City will then, following the receipt of the Supervising Professional's Certificate, make payment to the Contractor as soon as feasible, which is anticipated will be within 15 days.

An allowance may be made in progress payments if substantial quantities of permanent material have been delivered to the site but not incorporated in the completed work if the Contractor, in the opinion of the Supervising Professional, is diligently pursuing the work under this Contract. Such materials shall be properly stored and adequately protected. Allowance in the estimate shall be at the invoice price value of the items. Notwithstanding any payment of any allowance, all risk of loss due to vandalism or any damages to the stored materials remains with the Contractor.

In the case of Contracts which include only the Furnishing and Delivering of Equipment, the payments shall be; 60% of the Contract Sum upon the delivery of all equipment to be furnished, or in the case of delivery of a usable portion of the equipment in advance of the total equipment delivery, 60% of the estimated value of the portion of the equipment may be paid upon its delivery in advance of the time of the remainder of the equipment to be furnished; 30% of the Contract

Sum upon completion of erection of all equipment furnished, but not later than 60 days after the date of delivery of all of the equipment to be furnished; and payment of the final 10% on final completion of erection, testing and acceptance of all the equipment to be furnished; but not later than 180 days after the date of delivery of all of the equipment to be furnished, unless testing has been completed and shows the equipment to be unacceptable.

With each invoice for periodic payment, the Contractor shall enclose a Contractor's Declaration - Section 43, and an updated project schedule per Order of Completion - Section 2.

Section 17 - Deductions for Uncorrected Work

If the Supervising Professional decides it is inexpedient to correct work that has been damaged or that was not done in accordance with the Contract, an equitable deduction from the Contract price shall be made.

Section 18 - Correction of Work Before Final Payment

The Contractor shall promptly remove from the premises all materials condemned by the Supervising Professional as failing to meet Contract requirements, whether incorporated in the work or not, and the Contractor shall promptly replace and re-execute the work in accordance with the Contract and without expense to the City and shall bear the expense of making good all work of other contractors destroyed or damaged by the removal or replacement.

If the Contractor does not remove the condemned work and materials within 10 days after written notice, the City may remove them and, if the removed material has value, may store the material at the expense of the Contractor. If the Contractor does not pay the expense of the removal within 10 days thereafter, the City may, upon 10 days written notice, sell the removed materials at auction or private sale and shall pay to the Contractor the net proceeds, after deducting all costs and expenses that should have been borne by the Contractor. If the removed material has no value, the Contractor must pay the City the expenses for disposal within 10 days of invoice for the disposal costs.

The inspection or lack of inspection of any material or work pertaining to this Contract shall not relieve the Contractor of its obligation to fulfill this Contract and defective work shall be made good. Unsuitable materials may be rejected by the Supervising Professional notwithstanding that the work and materials have been previously overlooked by the Supervising Professional and accepted or estimated for payment or paid for. If the work or any part shall be found defective at any time before the final acceptance of the whole work, the Contractor shall forthwith make good the defect in a manner satisfactory to the Supervising Professional. The judgment and the decision of the Supervising Professional as to whether the materials supplied and the work done under this Contract comply with the requirements of the Contract shall be conclusive and final.

Section 19 - Acceptance and Final Payment

Upon receipt of written notice that the work is ready for final inspection and acceptance, the Supervising Professional will promptly make the inspection. When the Supervising Professional finds the work acceptable under the Contract and the Contract fully performed, the Supervising Professional will promptly sign and issue a final certificate stating that the work required by this Contract has been completed and is accepted by the City under the terms and conditions of the Contract. The entire balance found to be due the Contractor, including the retained percentage, shall be paid to the Contractor by the City within 30 days after the date of the final certificate.

Before issuance of final certificates, the Contractor shall file with the City:

- (1) The consent of the surety to payment of the final estimate;
- (2) The Contractor's Affidavit in the form required by Section 44.

In case the Affidavit or consent is not furnished, the City may retain out of any amount due the Contractor, sums sufficient to cover all lienable claims.

The making and acceptance of the final payment shall constitute a waiver of all claims by the City except those arising from:

- (1) unsettled liens;
- (2) faulty work appearing within 12 months after final payment;
- (3) hidden defects in meeting the requirements of the plans and specifications;
- (4) manufacturer's guarantees.

It shall also constitute a waiver of all claims by the Contractor, except those previously made and still unsettled.

Section 20 - Suspension of Work

The City may at any time suspend the work, or any part by giving 5 days notice to the Contractor in writing. The work shall be resumed by the Contractor within 10 days after the date fixed in the written notice from the City to the Contractor to do so. The City shall reimburse the Contractor for expense incurred by the Contractor in connection with the work under this Contract as a result of the suspension.

If the work, or any part, shall be stopped by the notice in writing, and if the City does not give notice in writing to the Contractor to resume work at a date within 90 days of the date fixed in the written notice to suspend, then the Contractor may abandon that portion of the work suspended and will be entitled to the estimates and payments for all work done on the portions abandoned, if any, plus 10% of the value of the work abandoned, to compensate for loss of overhead, plant expense, and anticipated profit.

Section 21 - Delays and the City's Right to Terminate Contract

If the Contractor refuses or fails to prosecute the work, or any separate part of it, with the diligence required to insure completion, ready for operation, within the allowable number of consecutive calendar days specified plus extensions, or fails to complete the work within the required time, the City may, by written notice to the Contractor, terminate its right to proceed with the work or any part of the work as to which there has been delay. After providing the notice the City may take over the work and prosecute it to completion, by contract or otherwise, and the Contractor and its sureties shall be liable to the City for any excess cost to the City. If the Contractor's right to proceed is terminated, the City may take possession of and utilize in completing the work, any materials, appliances and plant as may be on the site of the work and useful for completing the work. The right of the Contractor to proceed shall not be terminated or the Contractor charged with liquidated damages where an extension of time is granted under Extension of Time - Section 14.

If the Contractor is adjudged a bankrupt, or if it makes a general assignment for the benefit of creditors, or if a receiver is appointed on account of its insolvency, or if it persistently or repeatedly refuses or fails except in cases for which extension of time is provided, to supply enough properly skilled workers or proper materials, or if it fails to make prompt payments to subcontractors or for material or labor, or persistently disregards laws, ordinances or the instructions of the Supervising Professional, or otherwise is guilty of a substantial violation of any provision of the Contract, then the City, upon the certificate of the Supervising Professional that sufficient cause exists to justify

such action, may, without prejudice to any other right or remedy and after giving the Contractor 3 days written notice, terminate this Contract. The City may then take possession of the premises and of all materials, tools and appliances thereon and without prejudice to any other remedy it may have, make good the deficiencies or finish the work by whatever method it may deem expedient, and deduct the cost from the payment due the Contractor. The Contractor shall not be entitled to receive any further payment until the work is finished. If the expense of finishing the work, including compensation for additional managerial and administrative services exceeds the unpaid balance of the Contract Sum, the Contractor and its surety are liable to the City for any excess cost incurred. The expense incurred by the City, and the damage incurred through the Contractor's default, shall be certified by the Supervising Professional.

Section 22 - Contractor's Right to Terminate Contract

If the work should be stopped under an order of any court, or other public authority, for a period of 3 months, through no act or fault of the Contractor or of anyone employed by it, then the Contractor may, upon 7 days written notice to the City, terminate this Contract and recover from the City payment for all acceptable work executed plus reasonable profit.

Section 23 - City's Right To Do Work

If the Contractor should neglect to prosecute the work properly or fail to perform any provision of this Contract, the City, 3 days after giving written notice to the Contractor and its surety may, without prejudice to any other remedy the City may have, make good the deficiencies and may deduct the cost from the payment due to the Contractor.

Section 24 - Removal of Equipment and Supplies

In case of termination of this Contract before completion, from any or no cause, the Contractor, if notified to do so by the City, shall promptly remove any part or all of its equipment and supplies from the property of the City, failing which the City shall have the right to remove the equipment and supplies at the expense of the Contractor.

The removed equipment and supplies may be stored by the City and, if all costs of removal and storage are not paid by the Contractor within 10 days of invoicing, the City upon 10 days written notice may sell the equipment and supplies at auction or private sale, and shall pay the Contractor the net proceeds after deducting all costs and expenses that should have been borne by the Contractor and after deducting all amounts claimed due by any lien holder of the equipment or supplies.

Section 25 - Responsibility for Work and Warranties

The Contractor assumes full responsibility for any and all materials and equipment used in the construction of the work and may not make claims against the City for damages to materials and equipment from any cause except negligence or willful act of the City. Until its final acceptance, the Contractor shall be responsible for damage to or destruction of the project (except for any part covered by Partial Completion and Acceptance - Section 26). The Contractor shall make good all work damaged or destroyed before acceptance. All risk of loss remains with the Contractor until final acceptance of the work (Section 19) or partial acceptance (Section 26). The Contractor is advised to investigate obtaining its own builders risk insurance.

The Contractor shall guarantee the quality of the work for a period of one year. The Contractor shall also unconditionally guarantee the quality of all equipment and materials that are furnished and installed under the contract for a period of one year. At the end of one year after the Contractor's receipt of final payment, the complete work, including equipment and materials

furnished and installed under the contract, shall be inspected by the Contractor and the Supervising Professional. Any defects shall be corrected by the Contractor at its expense as soon as practicable but in all cases within 60 days. Any defects that are identified prior to the end of one year shall also be inspected by the Contractor and the Supervising Professional and shall be corrected by the Contractor at its expense as soon as practicable but in all cases within 60 days. The Contractor shall assign all manufacturer or material supplier warranties to the City prior to final payment. The assignment shall not relieve the Contractor of its obligations under this paragraph to correct defects.

Section 26 - Partial Completion and Acceptance

If at any time prior to the issuance of the final certificate referred to in Acceptance and Final Payment - Section 19, any portion of the permanent construction has been satisfactorily completed, and if the Supervising Professional determines that portion of the permanent construction is not required for the operations of the Contractor but is needed by the City, the Supervising Professional shall issue to the Contractor a certificate of partial completion, and immediately the City may take over and use the portion of the permanent construction described in the certificate, and exclude the Contractor from that portion.

The issuance of a certificate of partial completion shall not constitute an extension of the Contractor's time to complete the portion of the permanent construction to which it relates if the Contractor has failed to complete it in accordance with the terms of this Contract. The issuance of the certificate shall not release the Contractor or its sureties from any obligations under this Contract including bonds.

If prior use increases the cost of, or delays the work, the Contractor shall be entitled to extra compensation, or extension of time, or both, as the Supervising Professional may determine.

Section 27 - Payments Withheld Prior to Final Acceptance of Work

The City may withhold or, on account of subsequently discovered evidence, nullify the whole or part of any certificate to the extent reasonably appropriate to protect the City from loss on account of:

- (1) Defective work not remedied;
- (2) Claims filed or reasonable evidence indicating probable filing of claims by other parties against the Contractor;
- (3) Failure of the Contractor to make payments properly to subcontractors or for material or labor;
- (4) Damage to another Contractor.

When the above grounds are removed or the Contractor provides a Surety Bond satisfactory to the City which will protect the City in the amount withheld, payment shall be made for amounts withheld under this section.

Section 28 - Contractor's Insurance

- (1) The Contractor shall procure and maintain during the life of this Contract, including the guarantee period and during any warranty work, such insurance policies, including those set forth below, as will protect itself and the City from all claims for bodily injuries, death

or property damage which may arise under this Contract; whether the act(s) or omission(s) giving rise to the claim were made by the Contractor or by any subcontractor or anyone employed by them directly or indirectly. In the case of all contracts involving on-site work, the Contractor shall provide to the City, before the commencement of any work under this contract, certificates of insurance and other documentation satisfactory to the City demonstrating it has obtained the policies and endorsements required on behalf of itself, and when requested, any subcontractor(s). The certificates of insurance endorsements and/or copies of policy language shall document that the Contractor satisfies the following minimum requirements.

- (a) Worker's Compensation Insurance in accordance with all applicable state and federal statutes. Further, Employers Liability Coverage shall be obtained in the following minimum amounts:

Bodily Injury by Accident - \$500,000 each accident
Bodily Injury by Disease - \$500,000 each employee
Bodily Injury by Disease - \$500,000 each policy limit

- (b) Commercial General Liability Insurance equivalent to, as a minimum, Insurance Services Office form CG 00 01 07 98 or current equivalent. The City of Ann Arbor shall be named as an additional insured. There shall be no added exclusions or limiting endorsements specifically for the following coverages: Products and Completed Operations, Explosion, Collapse and Underground coverage or Pollution. Further there shall be no added exclusions or limiting endorsements which diminish the City's protections as an additional insured under the policy. The following minimum limits of liability are required:

\$1,000,000 Each occurrence as respect Bodily Injury Liability or Property
Damage Liability, or both combined.
\$2,000,000 Per Job General Aggregate
\$1,000,000 Personal and Advertising Injury
\$2,000,000 Products and Completed Operations Aggregate

- (c) Motor Vehicle Liability Insurance, including Michigan No-Fault Coverages, equivalent to, as a minimum, Insurance Services Office form CA 00 01 07 97 or current equivalent. Coverage shall include all owned vehicles, all non-owned vehicles and all hired vehicles. The City of Ann Arbor shall be named as an additional insured. There shall be no added exclusions or limiting endorsements which diminish the City's protections as an additional insured under the policy. Further, the limits of liability shall be \$1,000,000 for each occurrence as respects Bodily Injury Liability or Property Damage Liability, or both combined.

- (d) Umbrella/Excess Liability Insurance shall be provided to apply excess of the Commercial General Liability, Employers Liability and the Motor Vehicle coverage enumerated above, for each occurrence and for aggregate in the amount of \$1,000,000.

- (2) Insurance required under subsection (1)(b) and (1)(c) above shall be considered primary as respects any other valid or collectible insurance that the City may possess, including any self-insured retentions the City may have; and any other insurance the City does possess shall be considered excess insurance only and shall not be required to contribute with this insurance. Further, the Contractor agrees to waive any right of recovery by its insurer against the City.

- (3) Insurance companies and policy forms are subject to approval of the City Attorney, which

approval shall not be unreasonably withheld. Documentation must provide and demonstrate an unconditional 30 day written notice of cancellation in favor of the City of Ann Arbor. Further, the documentation must explicitly state the following: (a) the policy number; name of insurance company; name and address of the agent or authorized representative; name and address of insured; project name; policy expiration date; and specific coverage amounts; (b) any deductibles or self-insured retentions which shall be approved by the City, in its sole discretion; (c) that the policy conforms to the requirements specified Contractor shall furnish the City with satisfactory certificates of insurance and endorsements prior to commencement of any work. Upon request, the Contractor shall provide within 30 days a copy of the policy(ies) to the City. If any of the above coverages expire by their terms during the term of this Contract, the Contractor shall deliver proof of renewal and/or new policies and endorsements to the Administering Service Area/Unit at least ten days prior to the expiration date.

- (4) Any Insurance provider of Contractor shall be admitted and authorized to do business in the State of Michigan and shall carry and maintain a minimum rating assigned by A.M. Best & Company's Key Rating Guide of "A-" Overall and a minimum Financial Size Category of "V". Insurance policies and certificates issued by non-admitted insurance companies are not acceptable unless approved in writing by the City.
- (5) City reserves the right to require additional coverage and/or coverage amounts as may be included from time to time in the Detailed Specifications for the Project.
- (6) The provisions of General Condition 28 shall survive the expiration or earlier termination of this contract for any reason.

Section 29 - Surety Bonds

Bonds will be required from the successful bidder as follows:

- (1) A Performance Bond to the City of Ann Arbor for the amount of the bid(s) accepted;
- (2) A Labor and Material Bond to the City of Ann Arbor for the amount of the bid(s) accepted.

Bonds shall be executed on forms supplied by the City in a manner and by a Surety Company authorized to transact business in Michigan and satisfactory to the City Attorney.

Section 30 - Damage Claims

The Contractor shall be held responsible for all damages to property of the City or others, caused by or resulting from the negligence of the Contractor, its employees, or agents during the progress of or connected with the prosecution of the work, whether within the limits of the work or elsewhere. The Contractor must restore all property injured including sidewalks, curbing, sodding, pipes, conduit, sewers or other public or private property to not less than its original condition with new work.

Section 31 - Refusal to Obey Instructions

If the Contractor refuses to obey the instructions of the Supervising Professional, the Supervising Professional shall withdraw inspection from the work, and no payments will be made for work performed thereafter nor may work be performed thereafter until the Supervising Professional shall have again authorized the work to proceed.

Section 32 - Assignment

Neither party to the Contract shall assign the Contract without the written consent of the other. The Contractor may assign any monies due to it to a third party acceptable to the City.

Section 33 - Rights of Various Interests

Whenever work being done by the City's forces or by other contractors is contiguous to work covered by this Contract, the respective rights of the various interests involved shall be established by the Supervising Professional, to secure the completion of the various portions of the work in general harmony.

The Contractor is responsible to coordinate all aspects of the work, including coordination of, and with, utility companies and other contractors whose work impacts this project.

Section 34 - Subcontracts

The Contractor shall not award any work to any subcontractor without prior written approval of the City. The approval will not be given until the Contractor submits to the City a written statement concerning the proposed award to the subcontractor. The statement shall contain all information the City may require.

The Contractor shall be as fully responsible to the City for the acts and omissions of its subcontractors, and of persons either directly or indirectly employed by them, as it is for the acts and omissions of persons directly employed by it.

The Contractor shall cause appropriate provisions to be inserted in all subcontracts relative to the work to bind subcontractors to the Contractor by the terms of the General Conditions and all other contract documents applicable to the work of the subcontractors and to give the Contractor the same power to terminate any subcontract that the City may exercise over the Contractor under any provision of the contract documents.

Nothing contained in the contract documents shall create any contractual relation between any subcontractor and the City.

Section 35 - Supervising Professional's Status

The Supervising Professional has the right to inspect any or all work. The Supervising Professional has authority to stop the work whenever stoppage may be appropriate to insure the proper execution of the Contract. The Supervising Professional has the authority to reject all work and materials which do not conform to the Contract and to decide questions which arise in the execution of the work.

The Supervising Professional shall make all measurements and determinations of quantities. Those measurements and determinations are final and conclusive between the parties.

Section 36 - Supervising Professional's Decisions

The Supervising Professional shall, within a reasonable time after their presentation to the Supervising Professional, make decisions in writing on all claims of the City or the Contractor and on all other matters relating to the execution and progress of the work or the interpretation of the contract documents.

Section 37 - Storing Materials and Supplies

Materials and supplies may be stored at the site of the work at locations agreeable to the City unless specific exception is listed elsewhere in these documents. Ample way for foot traffic and drainage must be provided, and gutters must, at all times, be kept free from obstruction. Traffic on streets shall be interfered with as little as possible. The Contractor may not enter or occupy with agents, employees, tools, or material any private property without first obtaining written permission from its owner. A copy of the permission shall be furnished to the Supervising Professional.

Section 38 - Lands for Work

The Contractor shall provide, at its own expense and without liability to the City, any additional land and access that may be required for temporary construction facilities or for storage of materials.

Section 39 - Cleaning Up

The Contractor shall, as directed by the Supervising Professional, remove at its own expense from the City's property and from all public and private property all temporary structures, rubbish and waste materials resulting from its operations unless otherwise specifically approved, in writing, by the Supervising Professional.

Section 40 - Salvage

The Supervising Professional may designate for salvage any materials from existing structures or underground services. Materials so designated remain City property and shall be transported or stored at a location as the Supervising Professional may direct.

Section 41 - Night, Saturday or Sunday Work

No night or Sunday work (without prior written City approval) will be permitted except in the case of an emergency and then only to the extent absolutely necessary. The City may allow night work which, in the opinion of the Supervising Professional, can be satisfactorily performed at night. Night work is any work between 8:00 p.m. and 7:00 a.m. No Saturday work will be permitted unless the Contractor gives the Supervising Professional at least 48 hours but not more than 5 days notice of the Contractor's intention to work the upcoming Saturday.

Section 42 - Sales Taxes

Under State law the City is exempt from the assessment of State Sales Tax on its direct purchases. Contractors who acquire materials, equipment, supplies, etc. for incorporation in City projects are not likewise exempt. State Law shall prevail. The Bidder shall familiarize itself with the State Law and prepare its Bid accordingly. No extra payment will be allowed under this Contract for failure of the Contractor to make proper allowance in this bid for taxes it must pay.

Section 43

CONTRACTOR'S DECLARATION

I hereby declare that I have not, during the period _____, 20____, to _____, 20____, performed any work, furnished any materials, sustained any loss, damage or delay, or otherwise done anything in addition to the regular items (or executed change orders) set forth in the Contract titled _____, for which I shall ask, demand, sue for, or claim compensation or extension of time from the City, except as I hereby make claim for additional compensation or extension of time as set forth on the attached itemized statement. I further declare that I have paid all payroll obligations related to this Contract that have become due during the above period and that all invoices related to this Contract received more than 30 days prior to this declaration have been paid in full except as listed below.

There is/is not (Contractor please circle one and strike one as appropriate) an itemized statement attached regarding a request for additional compensation or extension of time.

Contractor

Date

By _____
(Signature)

Its _____
(Title of Office)

Past due invoices, if any, are listed below.

STANDARD SPECIFICATIONS

All work under this contract shall be performed in accordance with the Public Services Department Standard Specifications in effect at the date of availability of the contract documents stipulated in the Bid. All work under this Contract which is not included in these Standard Specifications, or which is performed using modifications to these Standard Specifications, shall be performed in accordance with the Detailed Specifications included in these contract documents.

Standard Specifications are available online:

<http://www.a2gov.org/departments/engineering/Pages/Engineering-and-Contractor-Resources.aspx>

DETAILED SPECIFICATIONS

CITY OF ANN ARBOR
DETAILED SPECIFICATION
FOR
CERTIFIED PAYROLL COMPLIANCE AND REPORTING

AA:MGN/DD

2 of 82

03/10/18

a. Description. This specification covers all administrative requirements, payroll reporting procedures to be followed by Contractors performing work on City-sponsored public improvements projects, and all other miscellaneous and incidental costs associated with complying with the applicable sections of the City of Ann Arbor Code of Ordinances with regard to payment of prevailing wages and its Prevailing Wage Compliance policy.

The intent of this specification is **not** to include the actual labor costs associated with the payment of prevailing wages as required. Properly incorporate those costs in all other contract items of work bid for the project.

b. General. The Contractor will comply with all applicable sections of Federal and State prevailing wage laws, duly promulgated regulations, the City of Ann Arbor Code of Ordinances, and its Prevailing Wage Compliance Policy as defined within the contract documents. The Contractor shall provide the required certified payrolls, city-required declarations, and reports requested elsewhere in the contract documents within the timeline(s) stipulated therein.

The Contractor shall also provide corrected copies of any submitted documents found to contain errors, omissions, inconsistencies, or other defects that render the report invalid. Provide the corrected copies when requested by the Supervising Professional.

The Contractor shall also attend any required meetings as needed to fully discuss and ensure compliance with the contract requirements regarding prevailing wage compliance. The Contractor shall require all employees engaged in on-site work to participate in, provide the requested information to the extent practicable, and cooperate in the interview process. The City of Ann Arbor will provide the needed language interpreters in order to perform wage rate interviews or other field investigations as needed.

Submit certified payrolls on City-provided forms or forms used by the Contractor, as long as the Contractor forms contain all required payroll information. If the Contractor elects to provide its own forms, the Supervising Professional shall approve of their use prior to the beginning of on-site work.

c. Unbalanced Bidding. The City of Ann Arbor will examine the submitted cost for this item of work prior to contract award. If the City determines, in its sole discretion that the costs bid by the Contractor for complying with the contract requirements are not reasonable, accurately reported or contain discrepancies, the City reserves the right to request additional documentation that fully supports and justifies the price as bid. Should the submitted information not be determined to be reasonable or justify the costs, the City reserves the right to pursue award of the contract to the second low bidder without penalty or prejudice to any other remedies that it may have or may elect to exercise with respect to the original low-bidder.

The City will not extend the contract completion date as a result of its investigation of the as-bid amount for this item of work, even if the anticipated contract award date must be adjusted. The only exception will be if the Contractor adequately demonstrates that their costs were appropriate and justifiable. In such case, the City will adjust the contract completion date by the number of calendar days commensurate with the length of its investigation if it cannot meet the published Notice to Proceed date of the work. The City will

not allow adjustments to contract unit prices for all other items of work due to the adjustment of contract completion date.

CITY OF ANN ARBOR
DETAILED SPECIFICATION
FOR
GENERAL CONDITIONS

AA:DAD

4 of 82

03/04/19

a. Description. This item comprises all work described and required by the plans and specifications at each project location for which the contract contains no item(s) of work, including but not limited to the following:

- Scheduling, coordination, and organization of all work, subcontractors, suppliers, testing, inspection, surveying, and staking.
- Coordination of, and cooperation with, other contractors, agencies, departments, and utilities.
- Protection and maintenance of utilities.
- Maintaining drainage.
- Furnishing, placement, and grading of maintenance gravel to construct any temporary driveways necessary for construction of the proposed work.
- Furnishing and installation of temporary pipe culverts including bedding and backfill materials.
- Maintaining driveways drive openings, sidewalks, bike paths, mail deliveries, and solid waste/recycle pick-ups. This includes the placement and maintenance of gravel in driveway openings as directed by the Engineer.
- Storing all materials and equipment off lawn areas.
- Temporary relocation and final replacement/re-setting of mailboxes.
- Coordination efforts to furnish various HMA mixtures as directed by the Engineer
- Coordination efforts to furnish and operate various-size vehicles/equipment as directed by the Engineer
- Furnishing and operating vacuum-type street cleaning equipment a minimum of once per week or more frequently as directed by the Engineer
- Protecting all sewers, and drainage and utility structures including manholes, gate wells, valve boxes, inlet structures, roadside ditches, and culverts from damage and contamination by debris and construction materials. Keeping structures and culverts clean of construction debris and properly covered/protected at all times during the construction. Immediately cleaning any structures, sewers, culverts and/or roadside ditches contaminated with construction debris resulting from Contractor operations and/or work activities.
- Disposing of excavated materials and debris - The Contractor shall dispose of, at the Contractor's expense, all excavated material. The Engineer will not pay any for any costs associated with work separately.
- Furnishing and operating vacuum-type utility structure cleaning equipment
- Furnishing and operating both vibratory plate and pneumatic-type ("pogo-stick") compactors
- Furnishing and operating a backhoe during all work activities
- Furnishing and operating a jackhammer and air compressor during all work activities

- Noise and dust control
- Mobilization(s) and demobilization(s).
- Project clean up.
- Furnishing submittals and certifications for materials and supplies.
- All miscellaneous and incidental items such as overhead, insurance, and permit fees.
- Meeting all requirements relating to Debarment Certification, Davis Bacon Act, and Disadvantaged Business Enterprise, and providing the necessary documentation.

The Appendix of the contract documents provides data pertaining to existing soil borings to assist the Engineer and Contractor with determining the soil conditions within the construction area. The City in no way guarantees existing conditions to be the same as shown in the data. The Contractor is solely responsible for any/all conclusions it may draw from the data.

Quantities as given are approximate and are estimates for bidding purposes. The City does not guarantee their totals and they may vary by any amount. While it is the City's intent to complete the project substantially as drawn and specified herein, quantities may be changed or reduced to zero for cost savings or other reasons. **The City reserves the right to change the quantities; however, the City will not allow the Contractor to adjust unit price(s) due to such change.**

b. Materials. None Specified.

c. Construction. Not specified.

CITY OF ANN ARBOR
DETAILED SPECIFICATION
FOR
MATERIAL AND SUPPLY SUBMITTALS AND CERTIFICATIONS

a. Description. This work includes submittal to the Engineer by the Contractor and its Subcontractors and prior to commencement of work; Michigan Department of Transportation Form 0501 showing all materials and supplies proposed for use on the project, and any product data information requested by the Engineer. It also includes furnishing certifications to the Engineer for review and approval a minimum of three business days prior to any scheduled delivery, installation, and/or construction of the same. The manufacturer or supplier shall certify the following materials and supplies are compliant with the contract specifications unless otherwise directed by the Engineer:

- Cement and lime
- Aggregates
- Admixtures and curing materials for concrete
- Asphaltic materials
- Steel reinforcement
- Structural steel
- Fencing materials
- Miscellaneous metal products
- Drainage products
- Geosynthetics
- Timber and lumber
- Masonry units
- Joint and waterproofing materials
- Bridge coating systems
- Erosion and sedimentation control materials
- Turf and landscaping materials
- Electrical and lighting materials
- Permanent traffic sign and support materials
- Permanent paving marking materials
- Permanent traffic signal materials
- Temporary traffic control materials
- Sanitary sewer materials
- Water main materials

b. Materials. None specified.

c. Construction. Not specified.

CITY OF ANN ARBOR
DETAILED SPECIFICATION
FOR
PROJECT SCHEDULE

AA:DAD

7 of 82

03/05/19

Complete the entirety of work under this Contract in accordance with, and subject to, the scheduling requirements as outlined below, and all other requirements of the Contract Documents.

The City expects to furnish the Contractor with two (2) copies of the Contract, for its execution, on or before **July 16, 2019**. The Contractor shall properly execute both copies of the Contract and return them, with the required Bonds and Insurance documentation, to the City by **July 31, 2019**. The Contractor shall not begin the work before the applicable date(s) as described herein without approval from the Project Engineer, and in no case before the receipt of the fully executed Contract and Notice to Proceed.

By no later than **August 9, 2019**, the Contractor shall submit a detailed schedule of work (progress schedule) for the Engineer's review and approval. The progress schedule must fully comply with the scheduling requirements contained on the Schedule of Streets. The schedule shall clearly indicate, in detail, the start and the finish date of each work task on each street. The Contractor shall update the approved progress schedule each week, and present it to the Engineer at the weekly progress meeting, and must consult with the Engineer for review and approval of any proposed deviations from the most current, approved, schedule.

The Contractor shall begin the work of this project on or after **September 3, 2019**, and only upon receipt of the fully executed Contract, Notice to Proceed and approved Progress Schedule. The City will consider granting appropriate time extensions should delays prevent the Contractor from starting work on this date.

If **Option A** is selected, complete restoration by **September 30, 2019**. Complete and open for use the asphalt shared use path along the entirety of Riverside Park by **October 15, 2019**. If **Option B** is selected, complete restoration by **October 15, 2019**. Complete and open for use the asphalt shared use path along the entirety of Riverside Park by **November 1, 2019**. This includes, but is not limited to removals and earthwork/machine grading; placement of base materials; placement of shared use path HMA, installation of furniture and concrete pads; site restoration; and other related work as required.

Failure to complete the work as specified, within the times specified, including time extensions granted thereto as determined by the Engineer, shall entitle the City to deduct from the payments due the Contractor **\$500.00** in "Liquidated Damages", and not as a penalty, for each and every calendar day the work remains incomplete beyond the date specified.

Time is of the essence in the performance of the work of this contract. The Contractor is expected to mobilize sufficient personnel and equipment and work throughout all authorized hours to complete the project by the intermediate (location specific) and final completion dates. Should the Contractor demonstrate that they must work on some Sundays in order to maintain the project schedule, they may do so between the hours of 9:00 a.m. and 5:00 p.m. with prior approval from the City. There will be no additional compensation due to the Contractor for work performed on Sundays.

The Engineer may delay or stop the work due to threatening weather conditions. No compensation shall be due the Contractor for unused materials or downtime due to rain, or the threat of rain. The Contractor is solely responsible for repairing all damages to the work and to the site, including any City infrastructure, and any adjacent properties resulting from its decision to work in the rain.

The Contractor shall not work in the dark except as approved by the Engineer and shall provide lighting for night work as detailed elsewhere in this contract. The Engineer may stop the work, or may require the Contractor to defer certain work to another day, if, in the Engineer's opinion, the Contractor cannot be complete the work within the remaining daylight hours, or if inadequate daylight is present to properly perform or inspect the work. No compensation shall be due to the Contractor for unused materials or downtime, when the Engineer directs work stoppage for reasons due to darkness and/or inadequate remaining daylight. The Contractor is solely responsible for

repairing all damages to the work and to the site, including any City infrastructure, and any adjacent properties, which result from working in the dark.

Assessment of Liquidated Damages will occur until the required work is complete in the current construction season. If, with the Engineer's approval, work extends beyond seasonal limitations, the assessment of Liquidated Damages will discontinue until the work resumes in the following construction season.

If the construction contract is not complete within the specified period(s) including any extensions of time granted thereto, at the sole discretion of the City of Ann Arbor it may terminate the Contract. Should this occur no additional compensation will be due to the Contractor, and the Contractor may be forbidden to bid on future City of Ann Arbor projects for a period of at least three (3) years. If the Engineer elects to terminate the Contract, payment for contract items with a Lump Sum unit price will be up to a maximum amount equal to the percentage of the contract work that is complete at the time of termination.

Include any/all to organize, coordinate, and schedule all of the project work in the contract unit price bid for the pay item **General Conditions, Mobilization, Bonds, Insurance, Permits.**

CITY OF ANN ARBOR

NOTICE TO BIDDERS

UTILITY COORDINATION

AA:DAD

9 of 82

03/05/19

The contractor shall cooperate and coordinate construction activities with the owners of utilities as stated in Section 104.08 of the 2012 Michigan Department of Transportation (MDOT) Standard Specifications for Construction. In addition, for the protection of underground utilities, the contractor shall follow the requirements in Section 107.12 of the 2012 MDOT Standard Specifications for Construction. Contractor delay claims, resulting from a utility, will be determined based upon Section 109.05.E of the 2012 MDOT Standard Specifications for Construction.

For protection of underground utilities and in conformance with Public Act 174 of 2013, the contractor shall dial 800-482-7171 or 811 a minimum of three (3) full working days, excluding Saturdays, Sundays, and holidays prior to beginning construction in areas where utilities have not been previously located. The "Miss Dig" alert system will then routinely notify members to locate and mark their facilities. This, however, does not relieve the contractor of the responsibility of notifying utility owners that may not be a part of the system.

There will be no requirement for owners of public or private utilities to move their facilities on or from within the street right-of-way if those facilities will not interfere with the proposed project work and they do not present a hazard to the public or an extraordinary hazard to the Contractor's operations.

The City will not require utilities owners to move additional poles or structures in order to facilitate the operation of construction equipment unless the Engineer determines that such poles or structures constitute a hazard to the public or are dangerous to the Contractor's operations.

Private utility owners will complete any/all necessary relocations prior to construction.

The following is a list of Private and Public Utilities that may or may not have facilities located within the Right-of-Way. This list is for informational purposes only and is not an exhaustive list of utilities located within the Right-of-Way.

ATT – Telecommunications/Fiber Optic
550 South Maple Road
Ann Arbor, MI 48103
Contact: Jeff Lehman 734-996-5334

City of Ann Arbor – Water, Storm, Sanitary, Telecommunications/Fiber Optic
W.R. Wheeler Service Center
4251 Stone School Road
Ann Arbor, MI 48108 734 794-6351

Comcast – Telecommunications/Fiber Optic
27800 Franklin Road
Southfield, MI 48034
Contact: Ron Sutherland 313-999-8300

DTE Energy – Electric & Street Lighting
8001 Haggerty Road
Belleville, MI 48111
Contact (Electric): Anthony Ignasiak 734-397-44447
Contact (Lighting): Lance Alley 734-397-4188

DTE Energy – Gas
3150 E. Michigan Ave
Ypsilanti Township, MI 48198
Contact: Robert Czapiewski 734-544-7818

MCI – Telecommunications/Fiber Optic
2800 North Glenfille Road
Richardson, TX 75082
Contact: Dean Boyers 972-729-6016

CITY OF ANN ARBOR
DETAILED SPECIFICATION
FOR
FENCE, PROTECTIVE, MODIFIED

AA:DAD

11 of 82

02/28/19

a. Description. This work consists of taking all reasonable measures to protect all existing trees and vegetation designated for protection within the project limits and the construction influence area, in accordance with subsection 201.03.A.2 and section 808 of the Michigan Department of Transportation (MDOT) 2012 Standard Specifications for Construction, as directed by the Engineer, and as specified herein. The work also consists of installing protective fencing at the limits of the construction area as shown on the plans or in areas directed by the Engineer.

b. Materials. Use orange, vinyl, snow fence fabric material, 4 feet tall. Use 6 foot long, T-shaped, metal posts or 2-inch square hardwood stakes.

c. Construction. Install protective fence at the limits of the construction area as shown on the plans or as directed by the Engineer.

Do not operate equipment within or beyond in any area(s) bounded by protection fence without the approval of the Engineer.

Do not stockpile or store construction material, supplies, and/or equipment within or beyond in any area(s) bounded by protection fence

The Engineer will not permit any vehicles and/or personnel within or beyond in any area(s) bounded by protection fence

The Contractor shall not attach chains, cables, ropes, nails, or other articles to any tree at any time.

Prune tree roots 1-1/2 inch or greater in diameter exposed during construction. The Engineer shall review and approve all pruning operations. Perform all root pruning with sharp tools and provide clean cuts so not damage the remaining bark or root. The Contractor shall not perform any backfilling operations until all root maintenance work is complete.

The City Forester or an approved forestry specialist will direct the repair(s) to any damaged to trees owned by the City of Ann Arbor or other trees designated for protection.

Damage to plant roots caused by Contractor operations to the extent the plant requires removal will result in one of the following actions:

1. The Contractor will replace the plant with a commensurate number of plants, 2½" caliper trees of the species as determined by the City.
2. Compensate the City of Ann Arbor for the cash value of the plant or tree as determined by the City of Ann Arbor's Forester.

The City of Ann Arbor is solely responsible for determining the corrective action and directing the Contractor as to which of above will be acceptable.

The City Forester will supervise the replacement of any trees.
Remove protection fence when directed by the Engineer.

CITY OF ANN ARBOR
DETAILED SPECIFICATION
FOR
GRADING SIDEWALKS, PATHS, AND DRIVEWAYS

AA:DAD

12 of 82

02/27/19

a. Description. Remove miscellaneous structures and materials, and complete all earthwork required to construct new and replacement sidewalks, sidewalk ramps, driveways, and driveway approaches to the lines and grades shown on the plans and/or as directed by the Engineer. Complete this work according to the Michigan Department of Transportation (MDOT) 2012 Standard Specifications for Construction, this detailed specification, and as directed by the Engineer.

b. Materials. Provide materials in accordance with subsection 205.02 of the MDOT 2012 Standard Specifications for Construction as necessary to achieve the required cross section(s). The Contractor may use excavated material, if suitable, as embankment with approval by the Engineer.

c. Construction. Complete this work according to applicable subsection 205.03 of the MDOT 2012 Standard Specifications for Construction. Grading for sidewalks and sidewalk ramps includes, but is not limited to, the following work:

1. Sawcutting existing pavements and curbs.
2. Stripping and stockpiling topsoil for use in turf establishment as approved.
3. Removing rocks or boulders less than 0.5 cubic yards in volume.
4. Excavating material to a depth necessary for construction.
5. Disposing of excess and unsuitable material according to section 205 of the MDOT 2012 Standards Specifications for Construction.
6. Furnishing and placing embankment material to the grades necessary for construction.
7. Shaping, grading, and compacting the subgrade and embankment to proposed grades to prepare it for subbase or aggregate base bedding materials or for an aggregate surface course.
8. Matching new sidewalk, sidewalk ramp, and driveway approach grades with existing grades as required.

CITY OF ANN ARBOR
DETAILED SPECIFICATION
FOR
AGGREGATE BASE

AA:DAD

13 of 82

03/05/19

a. Description. This work consists of constructing an aggregate base course on a surface approved by the Engineer using only crushed limestone. The aggregate base shall be in accordance with section 302 of the 2012 Michigan Department of Transportation (MDOT) Standard Specifications for Construction, except as herein modified:

b. Material. The aggregate material shall meet the requirements for Class 21AA dense-graded aggregate as specified in section 902 of the MDOT 2012 Standard Specifications for Construction. The ONLY permitted material shall be crushed limestone unless otherwise approved by the Engineer.

c. Construction. Construct aggregate base course in accordance subsection 302.03 of the 2012 MDOT Standard Specifications for Construction. Deliver Class 21AA dense-graded aggregate to the job site in a thoroughly blended condition and handle in such a manner that there will be no mixing of underlying soil with the base aggregate.

Measure the **aggregate base** compacted in place area respectively by the unit square yard and pay for them at their respective contract unit prices, which prices include costs for all labor, equipment and materials necessary to complete the work.

Weigh any/all unused/waste material on a certified scale to determine quantity(s), unless the Engineer approves an alternate method to arrive at these amount(s). Provide load weight tickets to the City's agent for any/all unused/waste material.

CITY OF ANN ARBOR
 DETAILED SPECIFICATION
 FOR
STRUCTURAL GEOGRID

OHM:BA/AA:DAD

14 of 82

5/23/2019

a. Description. This work consists of placing structural geogrid as shown in the plans, and as directed by the Engineer. Perform work in accordance with section 308 of the 2012 Michigan Department of Transportation (MDOT) Standard Specifications for Construction, except as herein provided.

b. Material. Furnish geogrid manufactured with high profile rectangular shaped ribs oriented radially in three or more directions to form uniform triangular shaped apertures having significant dimensional stability through all ribs and junctions of the geogrid structure to maintain reinforcement and aggregate confinement capabilities under repeated dynamic loads throughout the pavement life cycle. Furnish geogrid material resistant to ultraviolet degradation, all forms of biological and chemical degradation, and physical damage normally encountered in earth and road construction activities. Furnish geogrid having three-dimensional ribs with a depth to width ratio of at least 1.0 to optimize aggregate interlock, and the physical and geometric properties specified in Table 1 below for the designated 'Type' of geogrid material shown on the plans.

Table 1. Geogrid Properties

| Property | Test Method | TYPE | | | |
|--|---------------------------|---------------------|---------------------|----------|----------------------------|
| | | Subbase | Subgrade | Base | High Performance (HP) Base |
| Aperture (Aggregate) Size | | Small (Fine) | Large (V. Coarse) | Standard | Standard |
| Nominal Pitch ⁽²⁾ , mm | | 33 | 60 | 40 | 40 |
| Junction Efficiency ⁽³⁾ , % | ASTM D6637-10 D7737-11 | 93 | 93 | 93 | 93 |
| Aperture Stability ⁽⁴⁾ , kg-cm/deg @ 5.0 kg-cm | GRI-GG9 (Modified) | - | 3.0 | 3.0 | 3.6 |
| Radial Stiffness at Low Strain ⁽⁵⁾ , kN/m @ 0.5% Strain | ASTM D6637-10 | 200 | 350 | 225 | 300 |
| Isotropic Stiffness Ratio ⁽⁶⁾ | | - | 0.6 | | |
| Overall Flexural Rigidity, mg-cm | ASTM D7748-12 | 0.5x10 ⁶ | 2.0x10 ⁶ | | |
| Chemical Resistance ⁽⁷⁾ | EPA 9090 | 100% | 100% | 100% | 100% |
| Resistance to Ultra-Violet Light and Weathering ⁽⁸⁾ | ASTM D4355-05 | 70% | 70% | 70% | 70% |

1. Unless indicated otherwise, values shown are minimum average roll values (MARVs) determined in accordance with ASTM D4759-02. Brief descriptions of test procedures are given in the following notes.
2. Height of (triangular) aperture, measured node axis to rib.
3. Load transfer capability expressed as a percentage of ultimate tensile strength.
4. In-plane torsional rigidity measured by applying a moment to the central junction of a 225mm x 225mm specimen restrained at its perimeter.
5. Radial stiffness is determined from tensile stiffness measured in any in-plane axis from testing.
6. The ratio between the minimum and maximum observed values of radial stiffness at 0.5% strain, measured on rib and midway between rib directions.
7. Resistance to loss of load capacity or structural integrity when subjected to immersion testing in chemically aggressive environments.
8. Resistance to loss of load capacity or structural integrity when subjected to 500 hours of ultraviolet light and aggressive weathering.

Submit representative geogrid product sample, product data sheet, and the manufacturer's published installation guidelines. Basis for acceptance will be on a general certification, along with a certificate of analysis that confirms the geogrid material supplied meets the requirements of Table 1. The Engineer may sample and test material shipped to the project to verify certification documents.

The Engineer may consider alternate geogrid materials if they meet or exceed the project design intent. The Engineer must pre-approve alternate materials in writing by the Engineer prior to installation. Submit performance test data for evaluation at least two weeks prior to the anticipated shipment to the project. The Engineer will accept in-air laboratory testing alone for performance testing. Where applicable, calibrate the alternate geogrid material to the selected pavement design methodology furnish verification. The Engineer retains the sole discretion to approve alternate materials based on the submittal. Rejection of alternate material submittals shall not be the basis for any claim for additional compensation nor extension of time.

c. Construction. Protect stored materials from exposure to mud, wet concrete, epoxy or other deleterious materials. Store at temperatures above -20°F (-29°C). Lay flat or stand on end rolled materials. Do not store geogrid materials exposed to direct sunlight for extended periods as recommended by the manufacturer. The Engineer will reject geogrid materials with damage or manufacturing defects.

Prepare all areas immediately beneath the geogrid installation area per the plans and pertinent specifications. Install geogrid according to the manufacturer's recommendations. Place geogrid required only for immediately pending work to prevent undue exposure or damage to the geogrid, not to exceed 3 calendar days. After placing a layer of geogrid, use approved suitable means to anchor the geogrid in position until the subsequent backfill layer can be placed. Overlap adjacent rolls of geogrid as directed to maintain at least 1 ft overlap after backfill placement (larger overlaps may be necessary on softer subgrade soils).

Do not operate equipment directly on the geogrid. Place backfill outward from road embankment centerline, pushing a sufficient aggregate surcharge to assist in tensioning the geogrid without creating excessive wrinkles or damage. Do not operate tracked equipment on less than 6 inches of loose aggregate. Avoid sudden braking and sharp turning movements to prevent damage to the geogrid. Grade and compact cover aggregate according to the plans and relevant contract item specifications.

d. Measurement and Payment. Measure and pay for the completed work, as described, at the contract unit price using the following pay item:

Pay Item

Pay Unit

Structural Geogrid (Type) Square Yard

Measure **Structural Geogrid (Base Type)** in place area by the unit square yard and pay for it at contract unit price, which price includes costs for all labor, equipment and materials necessary to complete the work including placement and anchoring, hand work necessary to establish grades, splicing, and repairing protective coatings. The Engineer will make no allowance for overlap, splices, or material cut off or wasted.

SPECIAL PROVISION
FOR
SUBGRADE UNDERCUTTING, SPECIAL

B2B:STANTEC/AFT

1 of 1

03-01-2018

a. Description. The item of **Subgrade Undercutting, Special** shall be in accordance with Section 205 of the Standard Specifications for Construction except as herein specified. **Subgrade Undercutting, Special** shall include undercutting any unsuitable material as determined by the Engineer, placing geotextile separator, and placing backfill.

b. Materials. The material used for **Subgrade Undercutting, Special** shall meet the requirements as specified in Section 902 and 910 of the Michigan Department of Transportation 2012 Standard Specifications for Construction except as modified herein. The backfill material shall meet the requirements of MDOT 6A limestone aggregate, 21AA limestone aggregate, or Granular Material Class II as required.

c. Construction Methods. Construction methods shall follow Section 205 of the Standard Specifications for Construction. The Contractor shall excavate any areas where peat, muck, marl, underlying very soft clay, or other unacceptable material is present under the proposed path. Subgrade Undercutting, Special shall be performed as established by the Engineer, and the excavated material shall become the property of the Contractor.

Following removal of the material compact the undercut work area and allow inspection by the Engineer prior to backfilling. Geotextile, Separator shall be placed between the backfill material and the subgrade.

Backfill material shall be MDOT 6A limestone aggregate in high ground water areas, MDOT 21AA in dry clay areas, and Granular Material Class II in existing sandy areas. The Engineer must approve the backfill material for each undercut site.

CITY OF ANN ARBOR
DETAILED SPECIFICATION
FOR
SHARED USE PATH, HMA BASE CRUSHING AND SHAPING

AA:DAD

18 of 82

03/04/19

c. Description. This work consists of constructing new aggregate base from existing shared use path flexible pavement. Complete this work in accordance with section 305 of the 2012 Michigan Department of Transportation (MDOT) Standard Specifications for Construction, except as herein modified:

d. Material. Provide material in accordance with section 305.02 of the 2012 MDOT Standard Specifications for Construction, except that Class 21AA dense-graded aggregate shall ONLY be crushed limestone unless otherwise approved by the Engineer.

d. Construction. Perform work in accordance with subsection 305.03 of the 2012 MDOT Standard Specifications for Construction.

e. Measurement and Payment.

Basis for **Shared Use Path, HMA Base Crushing and Shaping** payment is on plan quantity, in accordance with subsection 109.01.A of the 2012 MDOT Standard Specifications for Construction, regardless of any variation in depth and includes costs for all labor, equipment and materials necessary to complete the work.

The unit price for **Shared Use Path, HMA Base Crushing and Shaping** includes the cost of water to obtain the required density, and scarifying, crushing, grading, shaping, rolling, and compacting existing HMA.

The Engineer will only pay for **Salv Crushed Material, LM** for use in other items of work if excess crushed material requires loading and hauling.

The Engineer will measure, and the City will pay for excess material loaded and hauled from locations on the project to attain the plan grade or cross section, in the final location as **Salv Crushed Material, LM** or as shoulder or approach material in accordance with subsection 307.04 of the 2012 MDOT Standard Specifications for Construction.

The City will only pay for **Material, Surplus and Unsuitable, Rem, LM** if the Contractor removes material from the project site and disposes in accordance with subsection 205.03.P of the 2012 MDOT Standard Specifications for Construction.

The City will pay separately for additional aggregate as **Aggregate Base**, in accordance with subsection 302.04 of the 2012 MDOT Standard Specifications for Construction. If **Aggregate Base** is not included in the contract, the City will pay for additional aggregate as extra work.

CITY OF ANN ARBOR
DETAILED SPECIFICATION
FOR
HOT MIX ASPHALT (HMA) APPLICATION ESTIMATE

AA:DAD

19 of 82

03/01/19

a. Description. Materials shall be furnished by the Contractor and this work shall be performed in accordance with the requirements of section 501, 504, 806, and 904 of the Michigan Department of Transportation (MDOT) 2012 Standard Specifications for Construction, and as herein specified.

b. Materials. Shared Use Path, HMA shall consist of 5E1 (top) and LVSP (leveling) and be applied in one lift at a rate of 220 pounds per square yard each, as shown on the plans, for a total thickness of four inches (two inches per lift). The top course will have 3% air voids and 25% max RAP content.

HMA, 5E1 shall have a yield of 220 pounds per square yard. This material will be placed in one lift (top) for a total thickness of two inches. The top course will have 3% air voids and 25% max RAP content.

HMA, LVSP shall have a yield of 220 pounds per square yard. This material will be placed in one lift (leveling) for a total thickness of two inches.

The Asphalt binder for Shared Use Path, HMA, HMA, LVSP and HMA 5E1 mixtures shall meet the Michigan Department of Transportation Performance Graded Asphalt Binder Specifications for PG 58-28.

The Bond Coat SS-1h materials shall be as specified per the Michigan Department of Transportation (MDOT) 2012 Standard Specifications for Construction. The application rate used on existing hot mix asphalt pavement, or between courses, shall be 0.08 – 0.12 gallons per square yard (0.10 gallons per square yard will be the target) for Shared Use Path, HMA, HMA, LVSP and HMA 5E1

.

CITY OF ANN ARBOR
DETAILED SPECIFICATION
FOR
HOT MIX ASPHALT (HMA) PAVING

AA:DAD

20 of 82

03/10/18

a. Description. Hot Mix Asphalt (HMA) pavement base, leveling, and top courses shall be constructed in accordance with section 501 of the Michigan Department of Transportation (MDOT) 2012 Standard Specifications for Construction, except as modified herein, and as directed by the Engineer.

b. Materials. None specified.

c. Construction.

1. Equipment: All equipment shall conform to subsection 501.03.A of the MDOT 2012 Standard Specifications for Construction, except as modified herein.

The Contractor shall have a 10-foot long straight edge, rubber-tired backhoe (Case 580 type, or equivalent), air-compressor with the ability to develop a minimum pressure of 100 pounds per square inch and continuous rated capacity of 150 cubic feet per minute of airflow, and jackhammer available during all paving operations. The Contractor shall be required to perform any miscellaneous cleaning, trimming, material removal, and other tasks as required by the Engineer in order to ensure the proper and orderly placement of all HMA materials on this project.

The Contractor shall provide sufficient rollers to achieve the specified asphalt densities.

At various times throughout the work, the Engineer may direct the Contractor to use smaller and/or lighter equipment, and to defer certain work tasks, in order to protect the grade and/or adjacent areas; including hauling units. The Contractor shall not be entitled to any additional compensation for the use of smaller equipment, lighter equipment, or work task deferral.

2. Cleaning and Bond Coat Application: Cleaning and bond coat application shall be performed in accordance with subsections 501.03.C and 501.03.D of the MDOT 2012 Standard Specifications for Construction, except as modified herein, and as directed by the Engineer.

The Contractor shall furnish and operate throughout the construction period, vacuum-type street cleaning and utility structure cleaning equipment (Vac-All, Vactor, etc.) approved by the Engineer, and when directed by the Engineer, for street cleaning immediately prior to, and for street and utility structure cleaning after any and all paving. The cleaning equipment shall be of sufficient power to remove dust, dirt, and debris from the pavement and from utility structures in and adjacent to the construction area. The Engineer shall approve the vac-all or similar equipment prior to beginning the work. The equipment used shall have an effective means for preventing any dust resulting from the operation from escaping into the air.

Apply bond coat at a rate of 0.10 gallons per square yard. Before placing the bond coat, the thoroughly clean the existing pavement surface. The Contractor shall also thoroughly clean all

joints, cracks, and edges to a minimum depth of one inch with compressed air, vac-all type equipment, or other approved mechanical or hand methods, to remove all dirt, debris, and all foreign material.

3. HMA Placement: Placement shall conform to subsection 501.03.F of the MDOT 2012 Standard Specifications for Construction, except as modified herein, and as directed by the Engineer.

HMA placement shall not commence until a "Permit to Place" (no additional costs are required to obtain this permit) has been issued in writing by the Engineer. The Engineer will issue a Permit to Place after approving the aggregate base course or the adjacent, underlying layer of pavement section.

The Engineer must approve the final structure adjustments prior to the issuance of the "Permit to Place" for the top course.

Place the top course with a ¼" lip along the edge of the curb and gutter/edge of metal.

All HMA thickness dimensions are compacted-in-place.

4. Paving Operation Scheduling: The Contractor shall schedule the paving operation to avoid leaving longitudinal cold joints "open" overnight.

In all cases, the Contractor shall pave the primary road's through-traffic lanes ("main line") first, from point-of-beginning to the point-of-ending. All other paving including, but not limited to; acceleration and deceleration lanes, intersection approaches, and center left-turn lanes shall be paved following completion of main line paving, unless authorized by the Engineer prior to the placement of any pavement.

5. Rate of Paver Operation: Maintain a paving machine rate of travel so that HMA placement and paving operation is continuous; resulting in no transverse cold joints. The rate of travel; however, shall never exceed 50 feet per minute.

The Contractor shall furnish and operate enough material, equipment, and hauling units to keep the paving machine(s) moving continuously at all times. Failure to do so shall be cause for the suspension of paving operations until the Contractor can demonstrate to the satisfaction of the Engineer that it has dedicated sufficient resources to perform the work in accordance with the project specifications.

6. Longitudinal and Transverse Joints: These joints shall conform to subsection 502.03.F of the MDOT 2012 Standard Specifications for Construction, and as specified herein.

For mainline HMA paving, the width of the mat for each pass of the paver shall be not less than 10.5 feet, or greater than 15 feet, except as noted in the plans and as directed by the Engineer. The Engineer will direct the layout of all HMA longitudinal joints during construction.

7. Feather Joints – shall be constructed so as to vary the thickness of the HMA from zero inches to the required paving thickness at the rate of approximately 1.5" over a distance of 10 feet, or as directed by the Engineer. The Contractor shall rake the larger pieces of aggregate out of feather joints prior to compaction.

8. **Butt Joints:** Construction of butt joints, where directed by the Engineer, shall conform to subsections 501.03.C.3 and 501.03.C.4 of the MDOT 2012 Standard Specifications for Construction, except as modified herein.

When the Engineer specifies or directs placement of a butt joint, remove the existing HMA surface to the thickness of the proposed overlay, or full-depth, as directed by the Engineer, for the full width or length of the joint. The HMA material shall be saw cut to the directed depth along the pavement edge or removal line to prevent tearing of the pavement surface. Cut joints that will be exposed in the completed surface must be cut with a saw or a cold-milling machine or other methods approved by the Engineer. Joints that will be covered by HMA must be cut with a saw, a cold-milling machine, or other methods approved by the Engineer.

9. **Rakers:** The Contractor shall provide a minimum of two asphalt rakers during the placement of all wearing and leveling courses.

10. **Faulty Mixtures:** The Contractor and Engineer shall carefully observe the paving operation for signs of faulty mixtures. The Contractor, at its sole expense, shall remove or correct points of weakness in the surface prior to paving subsequent lifts of HMA material. Such corrective action may include the removal and replacement of thin or contaminated sections of pavement, segregated HMA, and any sections that are weak or unstable. Once the Contractor or his representative is notified by the Engineer that the material being placed is out of allowable tolerances, or that there is a problem with the paving operation, the Contractor shall stop the paving operation at once, and shall not be permitted to continue placing HMA material until again authorized by the Engineer. The Engineer will not pay for separately any costs associated with meeting the above requirements, and will include them in the HMA work item(s) the Contractor was performing at the time of discovery of the faulty mixture.

d. Measurement and Payment. The contract includes no separate pay items for measurement and payment of the costs associated with meeting the requirements of this detailed specification. The Contractor shall include these costs in the unit prices bid for the HMA items in the contract.

The Contractor shall return any/all trucks to the plant with unused HMA remaining after the work is complete, and these trucks shall be re-weighed and the corrected weight slip provided to the Engineer. There will no payment any unused HMA material. All weight slips must include the type of mixture (codes are not acceptable), as well as vehicle number, gross weight, tare weight and net weight.

CITY OF ANN ARBOR
DETAILED SPECIFICATION
FOR
CONCRETE PLACEMENT AND PROTECTION

AA:DAD

23 of 82

02/28/19

a. Description. This work consists of furnishing all labor, material, and equipment necessary to furnish, place, and protect all concrete material in accordance with the Michigan Department of Transportation (MDOT) 2012 Standard Specifications for Construction and the requirements of this detailed specification. These requirements do not apply to concrete bridge decks, unless otherwise noted.

b. Materials. Use concrete meeting the requirements of sections 601 and 701 of the Michigan Department of Transportation (MDOT) 2012 Standard Specifications for Construction.

Propose specific concrete mix designs for the intended project purpose in accordance with the requirements of this detailed specification and other applicable detailed specifications and/or project requirements. The Engineer's acceptance of a mix design does not relieve the Contractor of its responsibility for the manufacture of the concrete mixture(s), the placement, or performance.

c. Construction. Perform all concrete placement operations in weather that is suitable for the successful placement and curing of the concrete materials. Do not place concrete during periods of active precipitation.

Complete all necessary formwork, base and/or sub-base preparation, and any other related items deemed necessary for the proper completion of the work. Do not commence with placement of concrete until the Engineer provides all needed approvals for placement. The Engineer's approval of the Contractor to place concrete shall not relieve the Contractor of its responsibility for the proper placement and protection of the concrete materials or its long-term performance.

During periods when precipitation is threatening, provide durable, plastic sheeting, approved by the Engineer, in sufficient quantity to cover and protect all freshly placed concrete and keep it from exposed to any precipitation. Arrange the placement of the plastic sheeting such that it does not mar the surface of any freshly placed concrete, and any/all seams in the plastic sheeting are watertight. Install adequate supports along and over the freshly placed concrete to prevent any contact between it and the plastic sheeting. Ensure placement of sufficient dams or barriers along the edges of freshly placed concrete to prevent erosion of the underlying materials or damage to the edges. All measures shall be effective.

Remove and replace any concrete damaged by precipitation. The Engineer will determine the extent of any damage and the limits of removal and replacement.

Place concrete only when the rate of surface evaporation at the site is less than 0.20 pounds per square foot per hour, according to figure 706-1 of the MDOT 2012 Standard Specifications for Construction. Provide approved equipment for determining the relative humidity and wind velocity at the site.

Perform the addition of water at the placement site in accordance with subsection 601.03.E.4 of the

MDOT 2012 Standard Specifications for Construction. Do not add water to placed concrete in order to aid finishing.

Perform concrete curing in accordance with subsection 602.03.M of the MDOT 2012 Standard Specifications for Construction. Curing operations will take precedence over texturing operations and continued concrete placement. Apply curing compound to achieve uniform coverage over the entire surface. Place curing compound so that it is free of spots, blotches, and/or uncovered or non-uniformly covered areas. Should the Engineer determine that any such areas exist, it will direct the Contractor to re-apply curing compound immediately at no additional cost to the project.

Take all precautions when placing concrete to protect it from damage due to the elements. Do not place concrete during precipitation events.

Protect concrete from weather and temperature according to the requirements of subsection 602.03.T of the MDOT 2012 Standard Specifications for Construction. Do not place concrete when the temperature of the plastic concrete mixture is greater than 90° F. Cover concrete with insulated blankets, or using other means approved by the Engineer, to protect it from damage during low temperature conditions. Protect concrete until it has reached a compressive strength of at least 1000 psi, or as directed by the Engineer.

d. Measurement and Payment. The contract includes no separate pay items for measurement and payment of the costs associated with meeting the requirements of this detailed specification. Include these costs in the unit price bids for the concrete items in the contract.

Removal and replacement, as determined and directed by the Engineer, of any concrete damaged by precipitation or cold weather is at the expense of the Contractor.

**DETAILED SPECIFICATIONS
FOR
TURF ESTABLISHMENT**

SCOPE OF THE WORK

The work covered by these specifications consist of furnishing all labor, equipment and materials, and performing all operations in connection with finish grading and turf establishment. The area to be included consists of all ground surface area that has been disturbed during the construction of any and all elements covered by this contract. Hydroseeding will be permitted with special authorization.

All work shall be done in accordance with Section 816, Turf Establishment, 916, Erosion and Sedimentation Control Materials, and 917, Turf and Landscaping Materials of the 2012 edition of the MDOT Standard Specifications, and the City of Ann Arbor Standard Specifications, except as modified herein, and as directed by the Supervising Professional.

MATERIALS

- A. **TOPSOIL** - Existing topsoil in areas to be disturbed shall be stripped, stockpiled where designated, and re-spread on the finished subgrade. Additional topsoil shall be furnished by the Contractor at his cost. It shall be good quality loamy topsoil, free from lumps, sod, stones, and other debris of any kind and approved by the Parks Department. Compost may called out to be applied to area, disc in to the top 4 inches.

- B. **SEED** - Grass seed shall be fresh, clean, new crop seed composed of the following varieties mixed in the proportions by weight shown and testing the minimum percentages of purity and germination indicated.

| <u>NAME</u> | <u>% BY WEIGHT</u> | <u>% PURITY</u> | <u>%</u> |
|---|--------------------|-----------------|----------|
| <u>GERMINATION</u> | | | |
| Kentucky bluegrass (Poapratensis) | 25 | 95 | 80 |
| Choose at least 2 of the following varieties: Enmundi, Touchdown, Sydsport, Adelphi, Glade, Majestic, A-34 (Ben-Sun), RAM I, Somerset, Mystic | | | |
| Kentucky bluegrass (Poaprantensis) | 25 | 95 | 80 |
| Choose at least 2 of the following varieties: America, Eclipse, Bristol, Challenger, Nassau, Georgetown, Baron | | | |

Turf-type perennial rye-

grass (Lolium perenne)
Choose at least 3 of the
following varieties:
Manhattan II, Palmer,
Yorktown II, Gater,
Prelude, Blazer,
Premier, Omega II

60

95

80

Due to limited quantities of certain varieties, substitutions may be used subject to Parks and Recreation approval.

OPERATION

- A. **REPLACING TOPSOIL** - Topsoil shall be placed on top of the finished sub-grade to a settled depth of three (3) inches and shall meet final grades as shown on the plans or designated on the site. The topsoil shall then be raked until there is a smooth even surface free from clay lumps, stones, roots, sod clumps and any other debris of more than two (2) inches in diameter which might be a hindrance to seeding operations.
- B. **SEEDING** - The approved dates for seeding are from April 1 to May 15, and from August 15 to September 15. The Contractor must make every effort to seed within these dates. Grass seed as specified shall be evenly sown at the rate of four (4) pounds per thousand square feet and lightly worked into the surface using a mechanical seeder such as a lawn maker or drill. Cultipacker or approved similar equipment may be used to cover the seed and form the seed bed in one operation.
- C. **MULCH** - Seeded areas are to be covered with a loosely applied layer of clean grain-free straw at the rate of two (2) tons per acre; or 3,000 pounds of straw.
- D. **ACCEPTANCE** - It is the responsibility of the Contractor to establish a dense lawn of permanent grasses, free from mounds and depressions. Any part of the area that fails to show a uniform germination shall be reseeded and such reseeding shall continue until a dense lawn is established. The Contractor shall keep seeded areas continually moist up to the time it is three (3) inches high and then he shall mow it. Damage to seeded area resulting from erosion shall be repaired by the Contractor. Scattered bare spots will not be allowed over three (3) percent of the area nor greater than one (1) square foot in size. When the above requirements of the specifications have been fulfilled, the Owner will accept the lawn.
- E. **TURF ESTABLISHMENT** - The Contractor shall be responsible for providing barricading (snow fence or the like) as necessary in high traffic areas until such time as the turf has fully established. At the Contractor's option, high traffic areas may be sodded to facilitate turf establishment.
- F. **HYDROSEEDING** - Areas approved to be sown by hydroseeding or broadcast method shall be floated and lightly compacted to incorporate the seed into the uppermost one-half inch of soil and covered with mulch. All areas that do not have successful seed germination within three weeks shall be re-seeded by the Contractor until the requirements for acceptance have been satisfied.

- G. **STEEP SLOPES** - Areas containing slopes greater than 1:2 (1'-0" vertical change per 2'-0" horizontal distance) shall be covered with "Excelsior Mulch Blankets" or an approved erosion control system. The blankets shall be placed with the netting on top and the fibers in contact with the soil over the entire area. The blankets shall be butted tightly against each other and stapled at three-foot intervals along joints, edges, and down the centerline of each blanket. As an alternative, the Contractor may install pegged sod. However, any slippage or die-out of sod sections must be repaired or replaced by the Contractor prior to final acceptance.

MEASUREMENT AND PAYMENT

Measurement of restoration items shall be by the square yard, in place.

The completed work as measured for these items of work will be paid for at the Contract Unit Prices for the following Contract (Pay) Items:

PAY ITEM

PAY UNIT

Restoration

Square Yard

The unit prices for these items of work shall include all labor, material, and equipment costs to perform all the work specified in the Standard Specifications and as modified by this Detailed Specification.

APPENDIX

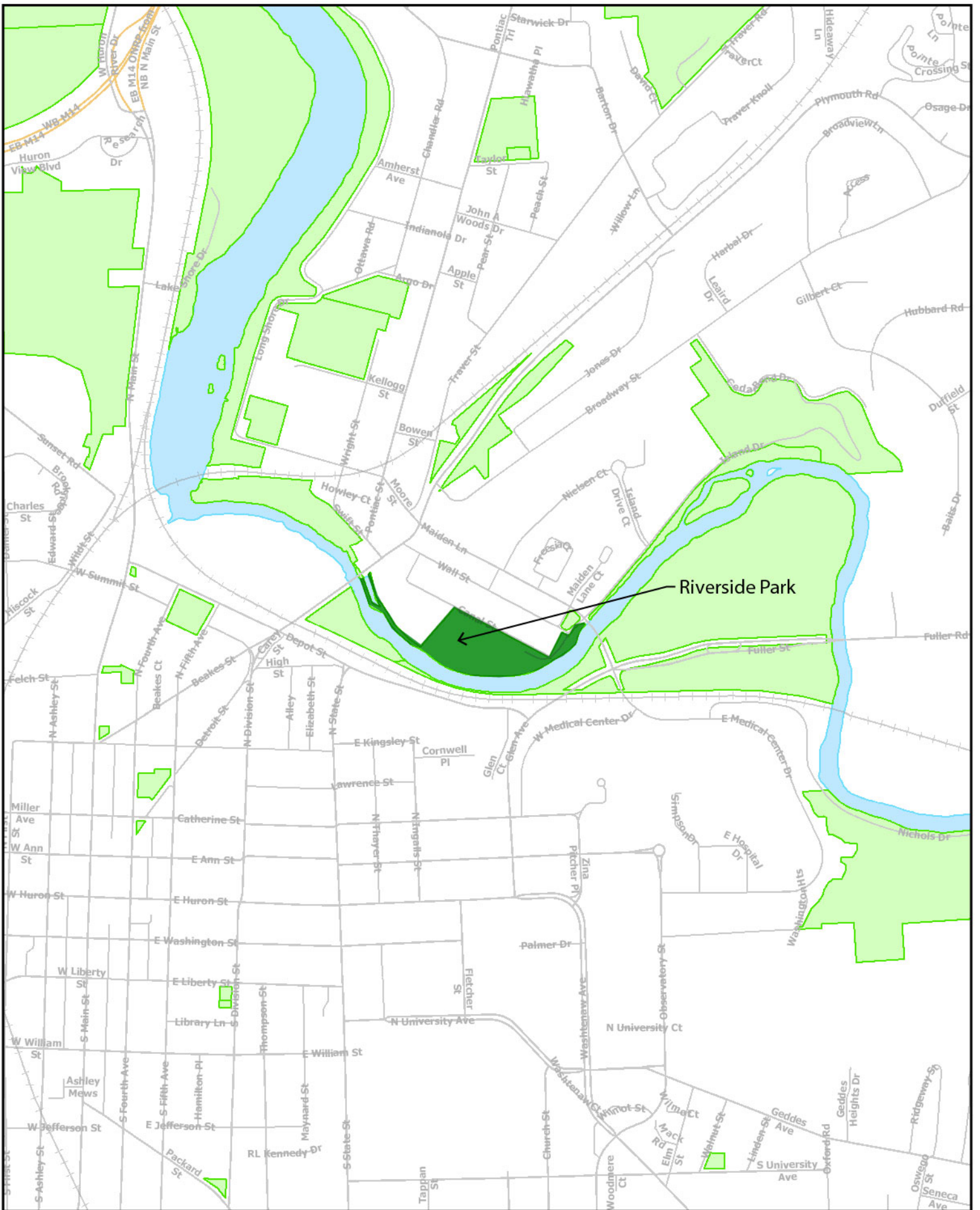

Riverside Park Location Map

1 inch = 1,000 feet





Riverside Park Asphalt Path Renovations - **PROJECT SITE PLAN**

Scale 1"=200'

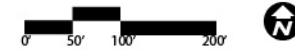



Riverside Park Asphalt Path Renovations - DETAILED PROJECT SITE PLAN

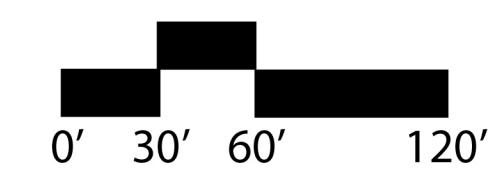

TO PRINT AT 24X36
1 inch = 60 feet



NOTE: CLEAR ALL VEGETATION TO 2' EACH SIDE OF TRAIL AND 8' VERTICAL AND RESTORE CLEARED AREA WITH LAWN.
RESTORE AND ESTABLISH TURF TO LIMITS OF DISTURBANCE.

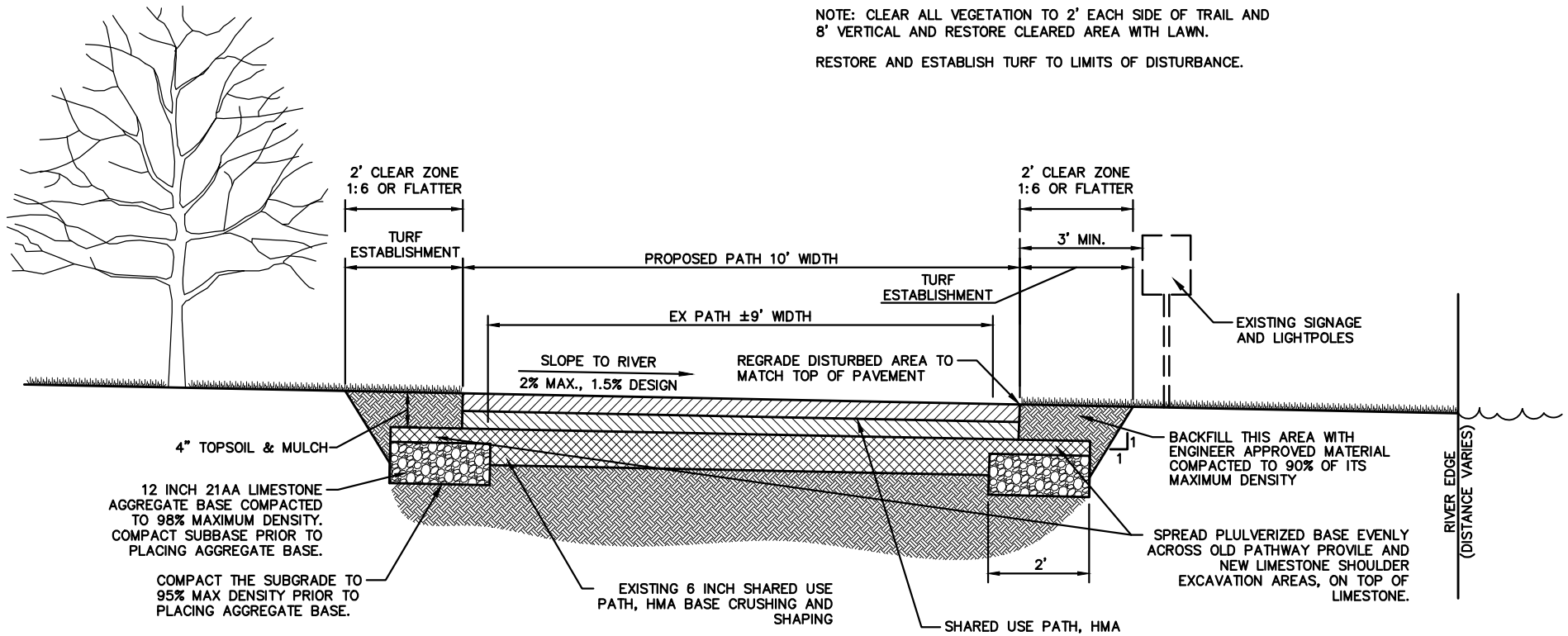

OPTION A - PROPOSED 10' WIDE BITUMINOUS SHARED USE PATH CROSS SECTION

N.T.S.



NOTE: CLEAR ALL VEGETATION TO 2' EACH SIDE OF TRAIL AND 8' VERTICAL AND RESTORE CLEARED AREA WITH LAWN.
 RESTORE AND ESTABLISH TURF TO LIMITS OF DISTURBANCE.

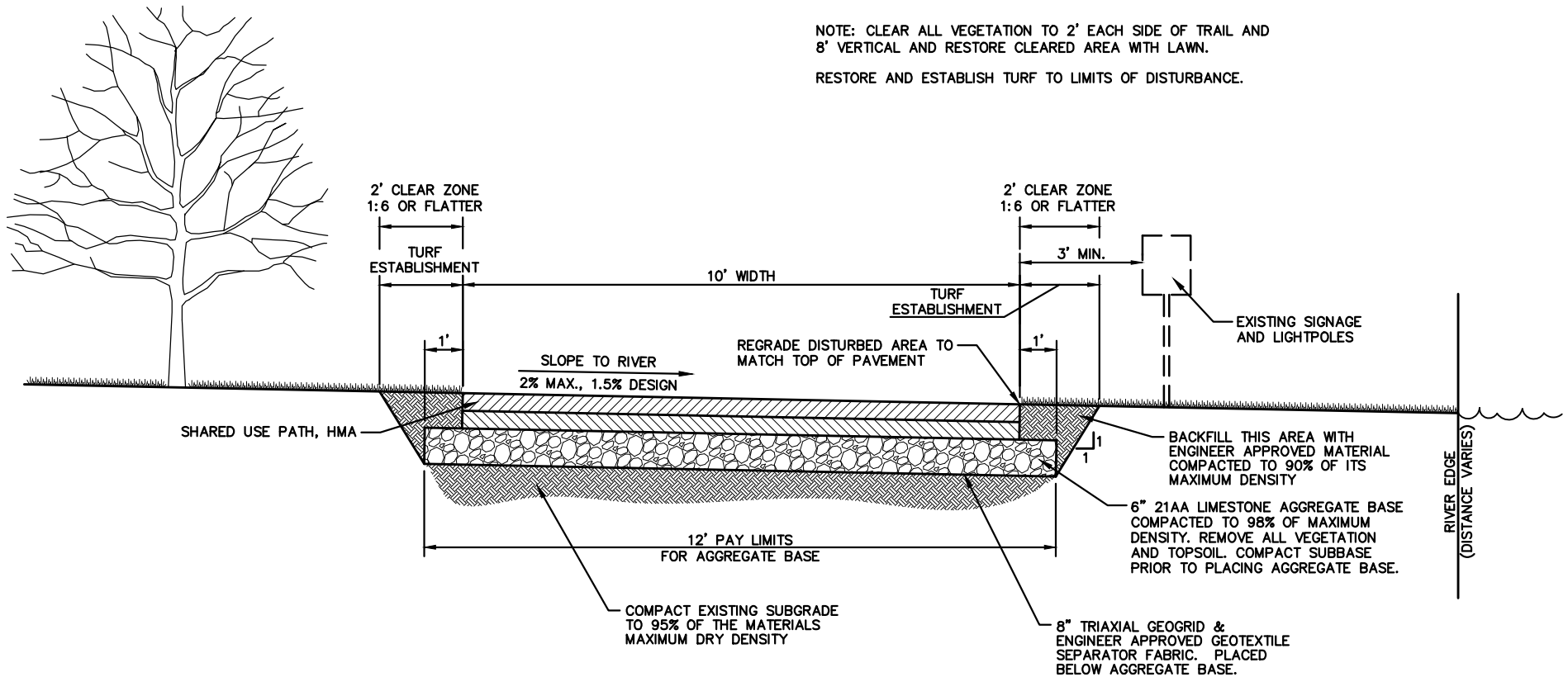

OPTION B - PROPOSED 10' WIDE BITUMINOUS SHARED USE PATH CROSS SECTION

N.T.S.



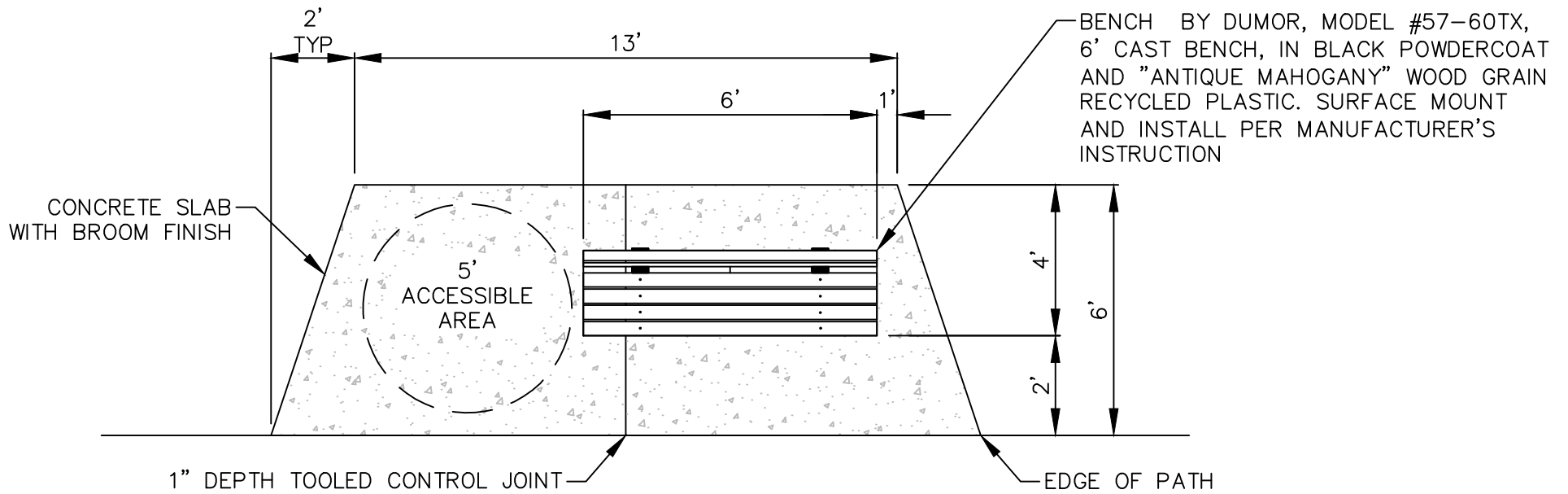

CUT ASPHALT TO A CLEAN EDGE PRIOR TO INSTALLATION FOR THOSE BENCHES LOCATED ADJACENT TO ASPHALT SURFACES

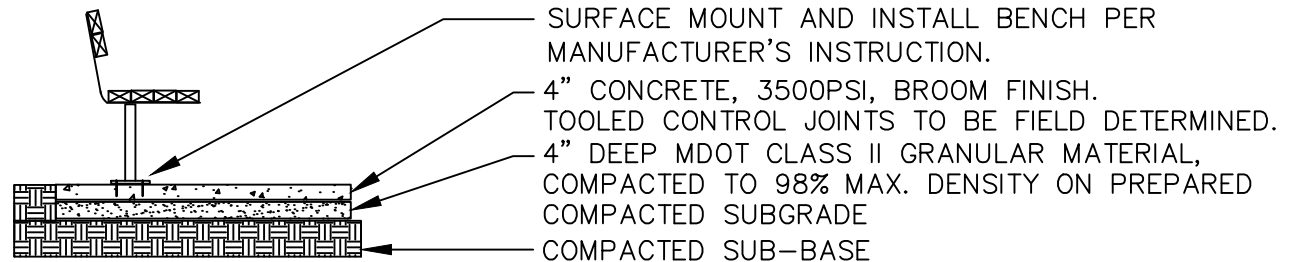

EXPOSED CONCRETE SHALL BE FORMED. BENCH SHALL BE INSTALLED PLUMB AND LEVEL. ALL NUTS AND BOLTS SHALL BE PERMANENTLY SET WITH PUNCH OR OTHER APPROVED MEANS

BENCH DETAIL

N.T.S.



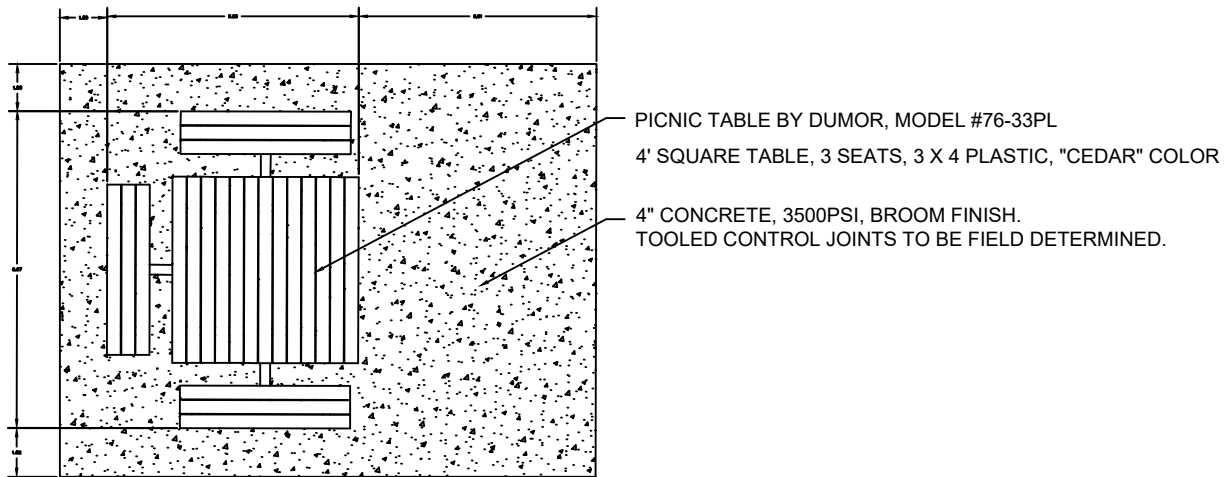
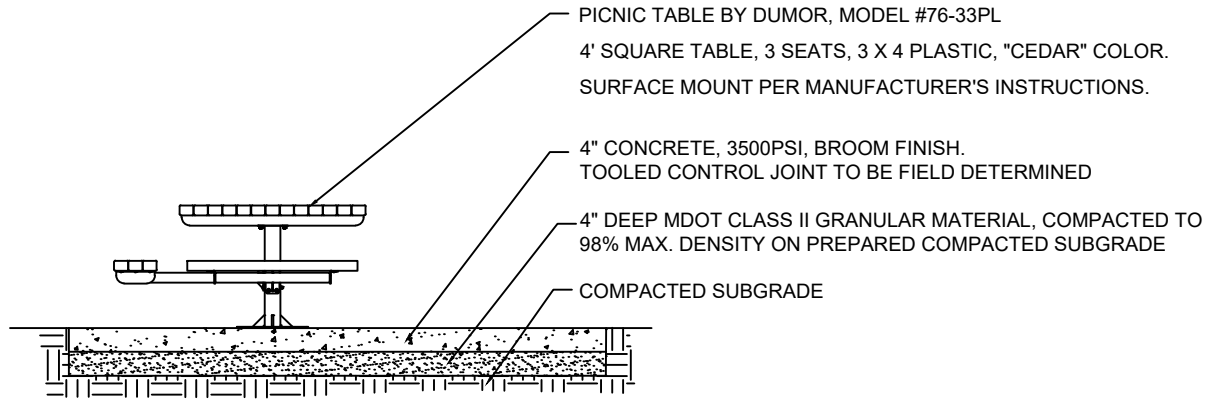

PICNIC TABLE
 No Scale



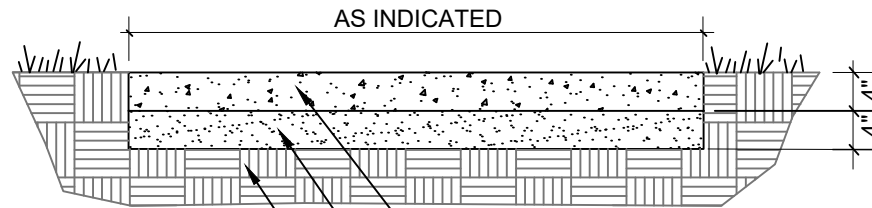

- 4" CONCRETE, 3500PSI, BROOM FINISH.
TOOLED CONTROL JOINT TO BE FIELD DETERMINED
- 4" DEEP MDOT CLASS II GRANULAR MATERIAL, COMPACTED TO
98% MAX. DENSITY ON PREPARED COMPACTED SUBGRADE
- COMPACTED SUBGRADE

CONCRETE WALK DETAIL

N.T.S.



CITY OF ANN ARBOR
LIVING WAGE ORDINANCE DECLARATION OF COMPLIANCE

The Ann Arbor Living Wage Ordinance (Section 1:811-1:821 of Chapter 23 of Title I of the Code) requires that an employer who is (a) a contractor providing services to or for the City for a value greater than \$10,000 for any twelve-month contract term, or (b) a recipient of federal, state, or local grant funding administered by the City for a value greater than \$10,000, or (c) a recipient of financial assistance awarded by the City for a value greater than \$10,000, shall pay its employees a prescribed minimum level of compensation (i.e., Living Wage) for the time those employees perform work on the contract or in connection with the grant or financial assistance. The Living Wage must be paid to these employees for the length of the contract/program.

Companies employing fewer than 5 persons and non-profits employing fewer than 10 persons are exempt from compliance with the Living Wage Ordinance. If this exemption applies to your company/non-profit agency please check here No. of employees__

The Contractor or Grantee agrees:

- (a) To pay each of its employees whose wage level is not required to comply with federal, state or local prevailing wage law, for work covered or funded by a contract with or grant from the City, no less than the Living Wage. The current Living Wage is defined as \$13.61/hour for those employers that provide employee health care (as defined in the Ordinance at Section 1:815 Sec. 1 (a)), or no less than \$15.18/hour for those employers that do not provide health care. The Contractor or Grantor understands that the Living Wage is adjusted and established annually on April 30 in accordance with the Ordinance and covered employers shall be required to pay the adjusted amount thereafter to be in compliance with Section 1:815(3).

Check the applicable box below which applies to your workforce

Employees who are assigned to any covered City contract/grant will be paid at or above the applicable living wage without health benefits

Employees who are assigned to any covered City contract/grant will be paid at or above the applicable living wage with health benefits

- (b) To post a notice approved by the City regarding the applicability of the Living Wage Ordinance in every work place or other location in which employees or other persons contracting for employment are working.
- (c) To provide to the City payroll records or other documentation within ten (10) business days from the receipt of a request by the City.
- (d) To permit access to work sites to City representatives for the purposes of monitoring compliance, and investigating complaints or non-compliance.
- (e) To take no action that would reduce the compensation, wages, fringe benefits, or leave available to any employee covered by the Living Wage Ordinance or any person contracted for employment and covered by the Living Wage Ordinance in order to pay the living wage required by the Living Wage Ordinance.

The undersigned states that he/she has the requisite authority to act on behalf of his/her employer in these matters and has offered to provide the services or agrees to accept financial assistance in accordance with the terms of the Living Wage Ordinance. The undersigned certifies that he/she has read and is familiar with the terms of the Living Wage Ordinance, obligates the Employer/Grantee to those terms and acknowledges that if his/her employer is found to be in violation of Ordinance it may be subject to civil penalties and termination of the awarded contract or grant of financial assistance.

 Company Name

 Street Address

 Signature of Authorized Representative

 Date

 City, State, Zip

 Print Name and Title

 Phone/Email address

CITY OF ANN ARBOR LIVING WAGE ORDINANCE

RATE EFFECTIVE APRIL 30, 2019 - ENDING APRIL 29, 2020

\$13.61 per hour

If the employer provides health care benefits*

\$15.18 per hour

If the employer does **NOT** provide health care benefits*

Employers providing services to or for the City of Ann Arbor or recipients of grants or financial assistance from the City of Ann Arbor for a value of more than \$10,000 in a twelve-month period of time must pay those employees performing work on a City of Ann Arbor contract or grant, the above living wage.

ENFORCEMENT

The City of Ann Arbor may recover back wages either administratively or through court action for the employees that have been underpaid in violation of the law. Persons denied payment of the living wage have the right to bring a civil action for damages in addition to any action taken by the City.

Violation of this Ordinance is punishable by fines of not more than \$500/violation plus costs, with each day being considered a separate violation. Additionally, the City of Ann Arbor has the right to modify, terminate, cancel or suspend a contract in the event of a violation of the Ordinance.

* Health Care benefits include those paid for by the employer or making an employer contribution toward the purchase of health care. The employee contribution must not exceed \$.50 an hour for an average work week; and the employer cost or contribution must equal no less than \$1/hr for the average work week.

The Law Requires Employers to Display This Poster Where Employees Can Readily See It.

**For Additional Information or to File a Complaint contact
Colin Spencer at 734/794-6500 or cspencer@a2gov.org**



| |
|--|
| Vendor Conflict of Interest Disclosure Form |
|--|

All vendors interested in conducting business with the City of Ann Arbor must complete and return the Vendor Conflict of Interest Disclosure Form in order to be eligible to be awarded a contract. Please note that all vendors are subject to comply with the City of Ann Arbor’s conflict of interest policies as stated within the certification section below.

If a vendor has a relationship with a City of Ann Arbor official or employee, an immediate family member of a City of Ann Arbor official or employee, the vendor shall disclose the information required below.

1. No City official or employee or City employee’s immediate family member has an ownership interest in vendor’s company or is deriving personal financial gain from this contract.
2. No retired or separated City official or employee who has been retired or separated from the City for less than one (1) year has an ownership interest in vendor’s Company.
3. No City employee is contemporaneously employed or prospectively to be employed with the vendor.
4. Vendor hereby declares it has not and will not provide gifts or hospitality of any dollar value or any other gratuities to any City employee or elected official to obtain or maintain a contract.
5. Please note any exceptions below:

| Conflict of Interest Disclosure* | |
|---|---|
| Name of City of Ann Arbor employees, elected officials or immediate family members with whom there may be a potential conflict of interest. | <input type="checkbox"/> Relationship to employee <hr style="border: 0; border-top: 1px solid black;"/> <input type="checkbox"/> Interest in vendor’s company <input type="checkbox"/> Other (please describe in box below) |
| | |

*Disclosing a potential conflict of interest does not disqualify vendors. In the event vendors do not disclose potential conflicts of interest and they are detected by the City, vendor will be exempt from doing business with the City.

| I certify that this Conflict of Interest Disclosure has been examined by me and that its contents are true and correct to my knowledge and belief and I have the authority to so certify on behalf of the Vendor by my signature below: | | |
|--|----------------------------|---|
| | | |
| Vendor Name | Vendor Phone Number | |
| | | |
| Signature of Vendor Authorized Representative | Date | Printed Name of Vendor Authorized Representative |
| | | |

Questions about this form? Contact Procurement Office City of Ann Arbor Phone: 734/794-6500, procurement@a2gov.org

CITY OF ANN ARBOR NON-DISCRIMINATION ORDINANCE

Relevant provisions of Chapter 112, Nondiscrimination, of the Ann Arbor City Code are included below.
You can review the entire ordinance at www.a2gov.org/humanrights.

Intent: It is the intent of the city that no individual be denied equal protection of the laws; nor shall any individual be denied the enjoyment of his or her civil or political rights or be discriminated against because of actual or perceived age, arrest record, color, disability, educational association, familial status, family responsibilities, gender expression, gender identity, genetic information, height, HIV status, marital status, national origin, political beliefs, race, religion, sex, sexual orientation, source of income, veteran status, victim of domestic violence or stalking, or weight.

Discriminatory Employment Practices: No person shall discriminate in the hire, employment, compensation, work classifications, conditions or terms, promotion or demotion, or termination of employment of any individual. No person shall discriminate in limiting membership, conditions of membership or termination of membership in any labor union or apprenticeship program.

Discriminatory Effects: No person shall adopt, enforce or employ any policy or requirement which has the effect of creating unequal opportunities according to actual or perceived age, arrest record, color, disability, educational association, familial status, family responsibilities, gender expression, gender identity, genetic information, height, HIV status, marital status, national origin, political beliefs, race, religion, sex, sexual orientation, source of income, veteran status, victim of domestic violence or stalking, or weight for an individual to obtain housing, employment or public accommodation, except for a bona fide business necessity. Such a necessity does not arise due to a mere inconvenience or because of suspected objection to such a person by neighbors, customers or other persons.

Nondiscrimination by City Contractors: All contractors proposing to do business with the City of Ann Arbor shall satisfy the contract compliance administrative policy adopted by the City Administrator in accordance with the guidelines of this section. All city contractors shall ensure that applicants are employed and that employees are treated during employment in a manner which provides equal employment opportunity and tends to eliminate inequality based upon any classification protected by this chapter. All contractors shall agree not to discriminate against an employee or applicant for employment with respect to hire, tenure, terms, conditions, or privileges of employment, or a matter directly or indirectly related to employment, because of any applicable protected classification. All contractors shall be required to post a copy of Ann Arbor's Non-Discrimination Ordinance at all work locations where its employees provide services under a contract with the city.

Complaint Procedure: If any individual believes there has been a violation of this chapter, he/she may file a complaint with the City's Human Rights Commission. The complaint must be filed within 180 calendar days from the date of the individual's knowledge of the allegedly discriminatory action or 180 calendar days from the date when the individual should have known of the allegedly discriminatory action. A complaint that is not filed within this timeframe cannot be considered by the Human Rights Commission. To file a complaint, first complete the complaint form, which is available at www.a2gov.org/humanrights. Then submit it to the Human Rights Commission by e-mail (hrc@a2gov.org), by mail (Ann Arbor Human Rights Commission, PO Box 8647, Ann Arbor, MI 48107), or in person (City Clerk's Office). For further information, please call the commission at 734-794-6141 or e-mail the commission at hrc@a2gov.org.

Private Actions For Damages or Injunctive Relief: To the extent allowed by law, an individual who is the victim of discriminatory action in violation of this chapter may bring a civil action for appropriate injunctive relief or damages or both against the person(s) who acted in violation of this chapter.

THIS IS AN OFFICIAL GOVERNMENT NOTICE AND
MUST BE DISPLAYED WHERE EMPLOYEES CAN READILY SEE IT.

MICHIGAN DEPARTMENT OF TRANSPORTATION CERTIFIED PAYROLL

COMPLETION OF CERTIFIED PAYROLL FORM FULFILLS THE MINIMUM MDOT PREVAILING WAGE REQUIREMENTS

(1) NAME OF CONTRACTOR / SUBCONTRACTOR (CIRCLE ONE) (2) ADDRESS

(3) PAYROLL NO. (4) FOR WEEK ENDING (5) PROJECT AND LOCATION (6) CONTRACT ID

| (a) | (b) | (c) | (d) DAY AND DATE | | | | | | | (e) | (f) | (g) | (h) | (i) | (j) DEDUCTIONS | | | | | | (k) | | |
|----------------------|---------------------|-----------|-------------------------|--|--|--|--|--|--|-----|-----|-----|--------|-----|------------------------|---------------------|----------------------------|----------------------|---------------------|------------------------------------|-----|--------|---------|
| | | | HOURS WORKED ON PROJECT | | | | | | | | | | | | TOTAL HOURS ON PROJECT | PROJECT RATE OF PAY | PROJECT RATE OF FRINGE PAY | GROSS PROJECT EARNED | GROSS WEEKLY EARNED | TOTAL WEEKLY HOURS WORKED ALL JOBS | | FICA | FEDERAL |
| EMPLOYEE INFORMATION | WORK CLASSIFICATION | Hour Type | | | | | | | | 0 | | | \$0.00 | | | | | | | | | \$0.00 | \$0.00 |
| NAME: | | | | | | | | | | 0 | | | \$0.00 | | | | | | | | | \$0.00 | \$0.00 |
| ETH#GEN: ID #: | GROUP/CLASS #: | S | | | | | | | | 0 | | | \$0.00 | | | | | | | | | \$0.00 | \$0.00 |
| NAME: | | | | | | | | | | 0 | | | \$0.00 | | | | | | | | | \$0.00 | \$0.00 |
| ETH#GEN: ID #: | GROUP/CLASS #: | S | | | | | | | | 0 | | | \$0.00 | | | | | | | | | \$0.00 | \$0.00 |
| NAME: | | | | | | | | | | 0 | | | \$0.00 | | | | | | | | | \$0.00 | \$0.00 |
| ETH#GEN: ID #: | GROUP/CLASS #: | S | | | | | | | | 0 | | | \$0.00 | | | | | | | | | \$0.00 | \$0.00 |
| NAME: | | | | | | | | | | 0 | | | \$0.00 | | | | | | | | | \$0.00 | \$0.00 |
| ETH#GEN: ID #: | GROUP/CLASS #: | S | | | | | | | | 0 | | | \$0.00 | | | | | | | | | \$0.00 | \$0.00 |
| NAME: | | | | | | | | | | 0 | | | \$0.00 | | | | | | | | | \$0.00 | \$0.00 |
| ETH#GEN: ID #: | GROUP/CLASS #: | S | | | | | | | | 0 | | | \$0.00 | | | | | | | | | \$0.00 | \$0.00 |
| NAME: | | | | | | | | | | 0 | | | \$0.00 | | | | | | | | | \$0.00 | \$0.00 |
| ETH#GEN: ID #: | GROUP/CLASS #: | S | | | | | | | | 0 | | | \$0.00 | | | | | | | | | \$0.00 | \$0.00 |
| NAME: | | | | | | | | | | 0 | | | \$0.00 | | | | | | | | | \$0.00 | \$0.00 |

Date _____

I, _____ (Name of Signatory Party) _____ (Title)

do hereby state:

(1) That I pay or supervise the payment of the persons employed by

_____ on the _____ (Contractor or Subcontractor)
 _____; that during the payroll period commencing on the _____ (Building or Work)
 _____ day of _____, _____, and ending the _____ day of _____, _____,
 all persons employed on said project have been paid the full weekly wages earned, that no rebates have been or will be made either directly or indirectly to or on behalf of said

_____ from the full _____ (Contractor or Subcontractor)

weekly wages earned by any person and that no deductions have been made either directly or indirectly from the full wages earned by any person, other than permissible deductions as defined in Regulations, Part 3 (29 C.F.R. Subtitle A), issued by the Secretary of Labor under the Copeland Act, as amended (48 Stat. 948, 63 Stat. 108, 72 Stat. 967; 76 Stat. 357; 40 U.S.C. § 3145), and described below:

(2) That any payrolls otherwise under this contract required to be submitted for the above period are correct and complete; that the wage rates for laborers or mechanics contained therein are not less than the applicable wage rates contained in any wage determination incorporated into the contract; that the classifications set forth therein for each laborer or mechanic conform with the work he performed.

(3) That any apprentices employed in the above period are duly registered in a bona fide apprenticeship program registered with a State apprenticeship agency recognized by the Bureau of Apprenticeship and Training, United States Department of Labor, or if no such recognized agency exists in a State, are registered with the Bureau of Apprenticeship and Training, United States Department of Labor.

(4) That:

(a) WHERE FRINGE BENEFITS ARE PAID TO APPROVED PLANS, FUNDS, OR PROGRAMS

- in addition to the basic hourly wage rates paid to each laborer or mechanic listed in the above referenced payroll, payments of fringe benefits as listed in the contract have been or will be made to appropriate programs for the benefit of such employees, except as noted in section 4(c) below.

(b) WHERE FRINGE BENEFITS ARE PAID IN CASH

- Each laborer or mechanic listed in the above referenced payroll has been paid, as indicated on the payroll, an amount not less than the sum of the applicable basic hourly wage rate plus the amount of the required fringe benefits as listed in the contract, except as noted in section 4(c) below.

(c) EXCEPTIONS

| EXCEPTION (CRAFT) | EXPLANATION |
|-------------------|-------------|
| | |
| | |
| | |
| | |
| | |
| | |
| | |
| | |
| | |
| | |

REMARKS:

| | |
|----------------|-----------|
| NAME AND TITLE | SIGNATURE |
| | |

THE WILLFUL FALSIFICATION OF ANY OF THE ABOVE STATEMENTS MAY SUBJECT THE CONTRACTOR OR SUBCONTRACTOR TO CIVIL OR CRIMINAL PROSECUTION. SEE SECTION 1001 OF TITLE 18 AND SECTION 231 OF TITLE 31 OF THE UNITED STATES CODE.