

CITY OF ANN ARBOR
INVITATION TO BID



Broadway / N. Division / Detroit Street
Planter Wall and Sidewalk Repair Project

ITB No. 4432

Due Date: April 20, 2016 at 2:00 p.m. EST

Public Services Area

Issued By:

City of Ann Arbor
Procurement Unit
301 E. Huron Street
Ann Arbor, MI 48104

TABLE OF CONTENTS

| | |
|-----------------------------------|------------|
| TABLE OF CONTENTS..... | TC-1 |
| NOTICE OF PRE-BID CONFERENCE..... | NP-1 |
| INSTRUCTIONS TO BIDDERS..... | IB-1 to 5 |
| INVITATION TO BID..... | ITB-1 to 3 |
| BID FORMS..... | BF-1 to 7 |
| CONTRACT..... | C-2 to 4 |
| BOND FORMS..... | B-1 to 2 |
| GENERAL CONDITIONS..... | GC-1 to 18 |
| STANDARD SPECIFICATIONS..... | SS-1 |
| DETAILED SPECIFICATION..... | DS-1 |

ATTACHMENTS

- City of Ann Arbor Prevailing Wage Declaration Form*
- City of Ann Arbor Living Wage Forms*
- City of Ann Arbor Vendor Conflict of Interest Disclosure Form*
- City of Ann Arbor Non-Discrimination Ordinance Notice and Declaration Form*

NOTICE OF PRE-BID CONFERENCE

A pre-bid conference for this project will be held on **April 6, 2016 at 2:30 p.m. EST** at the **Ann Arbor City Hall, 4th Floor Conference Room, Ann Arbor, MI.**

Attendance at this conference is highly recommended. Administrative and technical questions regarding this project will be answered at this time. The pre-bid conference is for information only. Any answers furnished will not be official until verified in writing by the Financial Service Area, Procurement Unit. Answers that change or substantially clarify the bid will be affirmed in an addendum.

INSTRUCTIONS TO BIDDERS

General

Work to be done under this Contract involves replacing a short section of retaining wall, replacing sidewalk and three sidewalk ramps, repairing a short curb section, replacing a small paver section with integral curb, and performing associated traffic control, earthwork and grading, and is generally described through the detailed specifications and project plans and must be completed fully in accordance with the contract documents. All work to be done under this Contract is located in the City of Ann Arbor.

Any Bid which does not conform fully to these instructions may be rejected.

Preparation of Bids

Bids shall be written in ink or typewritten. No erasures are permitted. Mistakes may be crossed out and corrected and must be initialed and dated in ink by the person signing the Bid.

Bids must be submitted on the "Bid Forms" provided with each blank properly filled in. If forms are not fully completed it may disqualify the bid. No alternative bid will be considered unless alternative bids are specifically requested. If alternatives are requested, any deviation from the specification must be fully described, in detail on the "Alternate" section of Bid form.

Each person signing the Bid certifies that he/she is the person in the Bidder's firm/organization responsible for the decision as to the fees being offered in the Bid and has not and will not participate in any action contrary to the terms of this provision.

Questions or Clarification on ITB Specifications

All questions regarding this ITB shall be submitted via email. Emailed questions and inquires will be accepted from any and all prospective Bidders in accordance with the terms and conditions of the ITB.

All questions shall be due on or before 2:00 p.m. on **April 11, 2016** and should be addressed as follows:

Specification/Scope of Work questions emailed to Michael G. Nearing, P.E., Senior Project Manager, mnearing@a2gov.org

Bid Process and HR Compliance questions emailed to Colin Spencer, Procurement Manager, cspencer@a2gov.org

Any error, omissions or discrepancies in the specification discovered by a prospective contractor and/or service provider shall be brought to the attention of Michael G. Nearing, P.E. after discovery as soon as possible. Further, the contractor and/or service provide shall not be allowed to take advantage of errors, omissions or discrepancies in the specifications.

Addenda

If it becomes necessary to revise any part of the ITB, a notice of the Addendum will be posted to Michigan Inter-governmental Trade Network (MITN) www.mitn.info and/or City of Ann Arbor web site www.A2gov.org for all parties to review and download.

Each Bidder must, in its Bid, avoid any miscommunications and acknowledge all addenda of which it is in receipt. The failure of a Bidder to receive, or acknowledge receipt of, any addenda shall not relieve the Bidder of the responsibility for complying with the terms thereof.

The City will not be bound by oral responses to inquiries or written responses other than written addenda.

Bid Submission

All Bids are due and must be delivered to the City of Ann Arbor Procurement Unit on or before **April 20, 2016 at 2:00 p.m. EST.** Bids submitted late or via oral, telephonic, telegraphic, electronic mail or facsimile **will not** be considered or accepted.

Each Bidder must submit one (1) original Bid in a sealed envelope clearly marked: **ITB No. 4432 – Broadway / N. Division / Detroit Street Planter Wall and Sidewalk Repair Project.**

Bids must be addressed and delivered to:

City of Ann Arbor
Procurement Unit,
c/o Customer Services, 1st Floor
301 East Huron Street
P.O. Box 8647
Ann Arbor, MI 48107

All Bids received on or before the Due Date will be publicly opened and recorded immediately. No immediate decisions are rendered.

The following forms provided within this ITB Document must be included in submitted bids.

- **City of Ann Arbor Prevailing Wage Declaration of Compliance**
- **City of Ann Arbor Living Wage Ordinance Declaration of Compliance**
- **Vendor Conflict of Interest Disclosure Form**
- **City of Ann Arbor Non-Discrimination Ordinance Declaration of Compliance**

Bids that fail to provide these completed forms listed above upon bid opening will be rejected as non-responsive and will not be considered for award.

Hand delivered bids will be date/time stamped/signed by the Procurement Unit at the address above in order to be considered. Normal business hours are 9:00 a.m. to 3:00 p.m. Monday through Friday, excluding Holidays. The City will not be liable to any Bidder for any unforeseen circumstances, delivery or postal delays. Postmarking to the Due Date will not substitute for receipt of the Bid. Each Bidder is responsible for submission of their Bid.

Additional time for submission of bids past the stated due date and time will not be granted to a single Bidder; however, additional time may be granted to all Bidders when the City determines in its sole discretion that circumstances warrant it.

Award

The City intends to award the Contract to the lowest responsible Bidder(s). For unit price bids, the Contract will be awarded based upon the unit and the lump sum prices stated by the bidder for the work items specified in the bid documents, with consideration given to any alternates

selected by the City. If the City determines that the unit price for any item is materially different for the work item bid than either other bidders or the general market, the City, in its sole discretion, in addition to any other right it may have, may reject the bid as not responsible or non-conforming.

The acceptability of major subcontractors will be considered in determining if a Bidder is responsible. In comparing Bids, the City will give consideration to alternate Bids for items listed in the bid forms. All key staff and subcontractors are subject to the approval by the City.

Official Documents

The City of Ann Arbor officially distributes bid documents from the Procurement Unit or through the Michigan Intergovernmental Trade Network (MITN). Copies of the bid documents obtained from any other source are not official copies. Addenda and other bid information will only be posted to these official distribution sites. If you obtained City of Ann Arbor Bid documents from other sources, it is recommended that you register on www.MITN.info and obtain an official set of bid documents.

Bid Security

Each bid must be accompanied by a certified check, or Bid Bond by a surety licensed and authorized to do business within the State of Michigan, in the amount of 5% of the total of the bid price.

Withdrawal of Bids

After the time of opening, no Bid may be withdrawn for the period of 60 days

Contract Time

Time is of the essence in the performance of the work under this Contract. The available time for work under this Contract is indicated on page C-2, Article III of the Contract. If these time requirements cannot be met, the Bidder must stipulate on Bid Form Section 3 - Time Alternate its schedule for performance of the work. Consideration will be given to time in evaluating bids.

Liquidated Damages

A liquidated damages clause, as given on page C-2, Article III of the Contract, provides that the Contractor shall pay the City as liquidated damages, and not as a penalty, a sum certain per day for each and every day that the Contractor may be in default of completion of the specified work, within the time(s) stated in the Contract, or written extensions.

Liquidated damages clauses, as given in the General Conditions, provide further that the City shall be entitled to impose and recover liquidated damages for breach of the obligations under Chapter 112 of the City Code.

The liquidated damages are for the non-quantifiable aspects of any of the previously identified events and do not cover actual damages that can be shown or quantified nor are they intended to preclude recovery of actual damages in addition to the recovery of liquidated damages.

Human Rights Information

All contractors proposing to do business with the City shall satisfy the contract compliance
2016 Construction

administrative policy adopted by the City Administrator in accordance with the Section 9:158 of the Ann Arbor City Code. Breach of the obligation not to discriminate as outlined in Section 5, beginning at page GC-3 shall be a material breach of the contract. Contractors are required to post a copy of Ann Arbor's Non-Discrimination Ordinance attached at all work locations where its employees provide services under a contract with the City.

Wage Requirements

Section 4, beginning at page GC-2, outlines the requirements for payment of prevailing wages and for payment of a "living wage" to employees providing service to the City under this contract. The successful bidder and its subcontractors must comply with all applicable requirements and provide documentary proof of compliance when requested.

For laborers whose wage level are subject to federal, state and/or local prevailing wage law the appropriate Davis-Bacon wage rate classification is identified based upon the work including within this contract. **The wage determination(s) current on the date 10 days before bids are due shall apply to this contract.** The U.S. Department of Labor (DOL) has provided explanations to assist with classification in the following resource link: www.wdol.gov

Conflict Of Interest Disclosure

The City of Ann Arbor Purchasing Policy requires that prospective Vendors complete a Conflict of Interest Disclosure form. A contract may not be awarded to the selected Vendor unless and until the Procurement Unit and the City Administrator have reviewed the Disclosure form and determined that no conflict exists under applicable federal, state, or local law or administrative regulation. Not every relationship or situation disclosed on the Disclosure Form may be a disqualifying conflict. Depending on applicable law and regulations, some contracts may be awarded on the recommendation of the City Administrator after full disclosure, where such action is allowed by law, if demonstrated competitive pricing exists and/or it is determined the award is in the best interest of the City. A copy of the Vendor Conflict of Interest Disclosure Form is attached.

Major Subcontractors

The Bidder shall identify on Bid Form Section 4 each major subcontractor it expects to engage for this Contract if the work to be subcontracted is 15% or more of the bid sum or over \$50,000, whichever is less. The Bidder also shall identify the work to be subcontracted to each major subcontractor. The Bidder shall not change or replace a subcontractor without approval by the City.

Debarment

Submission of a Bid in response to this ITB is certification that the Bidder is not currently debarred, suspended, proposed for debarment, and declared ineligible or voluntarily excluded from participation in this transaction by any State or Federal departments or agency. Submission is also agreement that the City will be notified of any changes in this status.

Disclosures

After bids are opened, all information in a submitter's bid is subjected to disclosure under the provisions of Michigan Public Act No. 442 of 1976, as amended (MCL 15.231 et seq.) known as

the "Freedom of Information Act." The Freedom of Information Act also provides for the complete disclosure of contracts and attachments thereto except where specifically exempted.

Bid Protest

All Bid protests must be in writing and filed with the Purchasing Agent within five (5) business days of the award action. The bidder must clearly state the reasons for the protest. If a bidder contacts a City Service Area/Unit and indicates a desire to protest an award, the Service Area/Unit shall refer the bidder to the Purchasing Agent. The Purchasing Agent will provide the bidder with the appropriate instructions for filing the protest. The protest shall be reviewed by the City Administrator or designee whose decision shall be final.

Cost Liability

The City of Ann Arbor assumes no responsibility or liability for costs incurred by the Bidder prior to the execution of a contract with the City. By submitting a bid, a bidder agrees to bear all costs incurred or related to the preparation, submission and selection process for the bid.

Reservation of Rights

The City of Ann Arbor reserves the right to accept any bid or alternative bid proposed in whole or in part, to reject any or all bids or alternatives bids in whole or in part and to waive irregularity and/or informalities in any bid and to make the award in any manner deemed in the best interest of the City.

INVITATION TO BID

City of Ann Arbor
Guy C. Larcom Municipal Building
Ann Arbor, Michigan 48107

Ladies and Gentlemen:

The undersigned, as Bidder, declares that this Bid is made in good faith, without fraud or collusion with any person or persons bidding on the same Contract; that this Bidder has carefully read and examined the bid documents, including City Nondiscrimination requirements and Declaration of Compliance Form, Living Wage requirements and Declaration of Compliance Form, Prevailing Wage requirements and Declaration of Compliance Form, Vendor Conflict of Interest Form, Notice of Pre-Bid Conference, Instructions to Bidders, Bid, Bid Forms, Contract, Bond Forms, General Conditions, Standard Specifications, Detailed Specifications, all Addenda, and the Plans (if applicable) and understands them. The Bidder declares that it conducted a full investigation at the site and of the work proposed and is fully informed as to the nature of the work and the conditions relating to the work's performance. The Bidder also declares that it has extensive experience in successfully completing projects similar to this one.

The Bidder acknowledges that it has not received or relied upon any representations or warrants of any nature whatsoever from the City of Ann Arbor, its agents or employees, and that this Bid is based solely upon the Bidder's own independent business judgment.

The undersigned proposes to perform all work shown on the plans or described in the bid documents, including any addenda issued, and to furnish all necessary machinery, tools, apparatus, and other means of construction to do all the work, furnish all the materials, and complete the work in strict accordance with all terms of the Contract of which this Bid is one part.

In accordance with these bid documents, and Addenda numbered _____, the undersigned, as Bidder, proposes to perform at the sites in and/or around Ann Arbor, Michigan, all the work included herein for the amounts set forth in the Bid Forms.

The Bidder declares that it has become fully familiar with the liquidated damage clauses for completion times and for compliance with City Code Chapter 112, understands and agrees that the liquidated damages are for the non-quantifiable aspects of non-compliance and do not cover actual damages that may be shown and agrees that if awarded the Contract, all liquidated damage clauses form part of the Contract.

The Bidder declares that it has become fully familiar with the provisions of Chapter 14, Section 1:320 (Prevailing wages) and Chapter 23 (Living Wage) of the Code of the City of Ann Arbor and that it understands and agrees to comply, to the extent applicable to employees providing services to the City under this Contract, with the wage and reporting requirements stated in the City Code provisions cited. Bidder certifies that the statements contained in the City Prevailing Wage and Living Wage Declaration of Compliance Forms are true and correct. Bidder further agrees that the cited provisions of Chapter 14 and Chapter 23 form a part of this Contract.

The Bidder declares that it has become familiar with the City Conflict of Interest Disclosure Form and certifies that the statement contained therein is true and correct.

The Bidder encloses a certified check or Bid Bond in the amount of 5% of the total of the Bid Price. The Bidder agrees both to contract for the work and to furnish the necessary Bonds and insurance documentation within 10 days after being notified of the acceptance of the Bid.

If this Bid is accepted by the City and the Bidder fails to contract and furnish the required Bonds and insurance documentation within 10 days after being notified of the acceptance of this Bid, then the Bidder shall be considered to have abandoned the Contract and the certified check or Bid Bond accompanying this Bid shall become due and payable to the City.

If the Bidder enters into the Contract in accordance with this Bid, or if this Bid is rejected, then the accompanying check or Bid Bond shall be returned to the Bidder.

In submitting this Bid, it is understood that the right is reserved by the City to accept any Bid, to reject any or all Bids, to waive irregularities and/or informalities in any Bid, and to make the award in any manner the City believes to be in its best interest.

SIGNED THIS _____ DAY OF _____, 201_.

Bidder's Name

Authorized Signature of Bidder

Official Address

(Print Name of Signer Above)

Telephone Number

Email Address for Award Notice

LEGAL STATUS OF BIDDER

(The Bidder shall fill out the appropriate form and strike out the other three.)

Bidder declares that it is:

* A corporation organized and doing business under the laws of the State of _____, for whom _____, bearing the office title of _____, whose signature is affixed to this Bid, is authorized to execute contracts.

NOTE: If not incorporated in Michigan, please attach the corporation's Certificate of Authority

• A limited liability company doing business under the laws of the State of _____, whom _____ bearing the title of _____ whose signature is affixed to this proposal, is authorized to execute contract on behalf of the LLC.

* A partnership, organized under the laws of the state of _____ and filed in the county of _____, whose members are (list all members and the street and mailing address of each) (attach separate sheet if necessary):

* An individual, whose signature with address, is affixed to this Bid: _____ (initial here)

Authorized Official

_____ **Date** _____, 201_

(Print) Name _____ Title _____

Company: _____

Address: _____

Contact Phone () _____ Fax () _____

Email _____

BID FORM

Section 1 - Schedule of Prices

Company: _____

Project: Broadway/N. Division/Detroit Street Planter Wall and Sidewalk Repair
File No. 2015-024 ITB No. 4432

ITEM NO. 1XX INDICATES CITY OF ANN ARBOR STANDARD PAY ITEM. SEE "PUBLIC SERVICES DEPT STANDARD SPECIFICATIONS"

ITEM NO. 2XX INDICATES CITY OF ANN ARBOR MODIFIED PAY ITEM. SEE DETAILED SPECIFICATIONS IN CONTRACT DOCUMENTS

ITEM NO. 3XX INDICATES MDOT STANDARD PAY ITEM. SEE "MDOT STANDARD SPECIFICATIONS FOR CONSTRUCTION, 2012"

| <u>Item</u> | <u>Description - Bid Item</u> | <u>Unit</u> | <u>Estimated Quantity</u> | <u>Unit Price</u> | <u>Estimated Cost</u> |
|-------------|--|-------------|-------------------------------|-------------------|-----------------------|
| 101 | General Conditions | LS | 1 | x \$ _____ | = \$ _____ |
| 201 | Sidewalk, Ramp, Conc, 6 inch, ADA, Modified | EACH | 891 | x \$ _____ | = \$ _____ |
| 202 | Sign, Rem, Salv, Reinstall | EACH | 1 | x \$ _____ | = \$ _____ |
| 203 | Detectable Warning Tiles | SFT | 46 | x \$ _____ | = \$ _____ |
| 204 | Conc Curb Head | FT | 6 | x \$ _____ | = \$ _____ |
| 301 | Excavation, Fdn | CYD | 14 | x \$ _____ | = \$ _____ |
| 302 | Backfill, Structure, CIP | CYD | 13 | x \$ _____ | = \$ _____ |
| 303 | Structures, Rehabilitation, Rem Portions | LS | 1 | x \$ _____ | = \$ _____ |
| 304 | Conc, Grade S2 | CYD | 7 | x \$ _____ | = \$ _____ |
| 305 | Reinforcement, Steel, Epoxy Coated | LB | 161 | x \$ _____ | = \$ _____ |
| 306 | Festuca Ovina Glauca 'Elijah Blue', #2 | EACH | 30 | x \$ _____ | = \$ _____ |
| 307 | Mulch | SYD | 15 | x \$ _____ | = \$ _____ |
| 308 | Topsoil Surface, Furn, 8 inch | SYD | 15 | x \$ _____ | = \$ _____ |
| 309 | Sidewalk, Rem | LS | 1 | x \$ _____ | = \$ _____ |
| 310 | Shared use Path, Grading | SYD | 116 | x \$ _____ | = \$ _____ |
| 311 | Curb, Rem | FT | 6 | x \$ _____ | = \$ _____ |

BF-1 Sub-total = \$ _____

BID FORM

Section 1 - Schedule of Prices

Company: _____

Project: Broadway/N. Division/Detroit Street Planter Wall and Sidewalk Repair
 File No. 2015-024 ITB No. 4432

| <u>Item</u> | <u>Description - Bid Item</u> | <u>Unit</u> | <u>Estimated Quantity</u> | <u>Unit Price</u> | <u>Estimated Cost</u> |
|-------------|--|-------------|-------------------------------|-------------------|---------------------------|
| 312 | Minor Traffic Devices | LSUM | 1 | x \$ _____ | = \$ _____ |
| | Barricade, Type III, high Intensity, Double | | | | |
| 313 | Sided, Lighted, Furn | EA | 10 | x \$ _____ | = \$ _____ |
| | Barricade, Type III, high Intensity, Double | | | | |
| 314 | Sided, Lighted, Oper | EA | 10 | x \$ _____ | = \$ _____ |
| 315 | Lighted Arrow, Type C, Furn | EA | 2 | x \$ _____ | = \$ _____ |
| 316 | Lighted Arrow, Type C, Oper | EA | 2 | x \$ _____ | = \$ _____ |
| | Pavt Mrkg, Wet Reflective Type R, Tape, | | | | |
| 317 | White, Temp | FT | 325 | x \$ _____ | = \$ _____ |
| | Pavt Mrkg, Wet Reflective Type R, Tape, | | | | |
| 318 | Yellow, Temp | FT | 165 | x \$ _____ | = \$ _____ |
| 319 | Plastic Drum, High Intensity, Furn | EA | 65 | x \$ _____ | = \$ _____ |
| 320 | Plastic Drum, High Intensity, Oper | EA | 65 | x \$ _____ | = \$ _____ |
| 321 | Sign Cover | EA | 5 | x \$ _____ | = \$ _____ |
| 322 | Sign, Type B, Temp, Prismatic, Furn | SFT | 482 | x \$ _____ | = \$ _____ |
| 323 | Sign, Type B, Temp, Prismatic, Oper | SFT | 482 | x \$ _____ | = \$ _____ |
| 324 | Sign, Type B, Temp, Prismatic, Special, Furn | SFT | 11 | x \$ _____ | = \$ _____ |
| 325 | Sign, Type B, Temp, Prismatic, Special, Oper | SFT | 11 | x \$ _____ | = \$ _____ |

BF-2 Sub-total = \$ _____

BF-1 Sub-total = \$ _____

Project Total = \$ _____

BID FORM

Section 2 - Material and Equipment Alternates

The Base Bid proposal price shall include materials and equipment selected from the designated items and manufacturers listed in the bidding documents. This is done to establish uniformity in bidding and to establish standards of quality for the items named.

If the Contractor wishes to quote alternate items for consideration by the City, it may do so under this Section. A complete description of the item and the proposed price differential must be provided. Unless approved at the time of award, substitutions where items are specifically named will be considered only as a negotiated change in Contract Sum.

| <u>Item Number</u> | <u>Description</u> | <u>Add/Deduct Amount</u> |
|--------------------|--------------------|--------------------------|
|--------------------|--------------------|--------------------------|

If the Bidder does not suggest any material or equipment alternate, the Bidder **MUST** complete the following statement:

For the work outlined in this request for bid, the bidder does NOT propose any material or equipment alternate under the Contract.

Signature of Authorized Representative of Bidder _____ Date _____

BID FORM

Section 3 - Time Alternate

If the Bidder takes exception to the time stipulated in Article III of the Contract, Time of Completion, page C-2, it is requested to stipulate below its proposed time for performance of the work. Consideration will be given to time in evaluating bids.

If the Bidder does not suggest any time alternate, the Bidder **MUST** complete the following statement:

For the work outlined in this request for bid, the bidder does NOT propose any time alternate under the Contract.

Signature of Authorized Representative of Bidder _____ Date _____

BID FORM

Section 4 - Major Subcontractors

For purposes of this Contract, a Subcontractor is anyone (other than the Contractor) who performs work (other than or in addition to the furnishing of materials, plans or equipment) at or about the construction site, directly or indirectly for or on behalf of the Contractor (and whether or not in privity of Contract with the Contractor), but shall not include any individual who furnishes merely the individual's own personal labor or services.

Contractor agrees that all subcontracts entered into by the Contractor shall contain similar wage provision to Section 4 of the General Conditions covering subcontractor's employees who perform work on this contract.

For the work outlined in these documents the Bidder expects to engage the following major subcontractors to perform the work identified:

| <u>Subcontractor (Name and Address)</u> | <u>Work</u> | <u>Amount</u> |
|---|-------------|---------------|
|---|-------------|---------------|

If the Bidder does not expect to engage any major subcontractor, the Bidder **MUST** complete the following statement:

For the work outlined in this request for bid, the bidder does NOT expect to engage any major subcontractor to perform work under the Contract.

Signature of Authorized Representative of Bidder _____ Date _____

BID FORM

Section 5 – References

Include a minimum of 3 references from similar projects completed within the past 3 years.

[Refer also to Instructions to Bidders for additional requirements, if any]

1) _____
Project Name Cost Date Constructed

Contact Name Phone Number

2) _____
Project Name Cost Date Constructed

Contact Name Phone Number

3) _____
Project Name Cost Date Constructed

Contact Name Phone Number

SAMPLE STANDARD CONTRACT

If a contract is awarded, the selected contractor will be required to adhere to a set of general contract provisions which will become a part of any formal agreement. These provisions are general principles which apply to all contractors of service to the City of Ann Arbor such as the following:

CONTRACT

THIS AGREEMENT is made on the _____ day of _____, 2016, between the CITY OF ANN ARBOR, a Michigan Municipal Corporation, 301 East Huron Street, Ann Arbor, Michigan 48104 ("City") and _____ ("Contractor")

(An individual/partnership/corporation, include state of incorporation)

(Address)

Based upon the mutual promises below, the Contractor and the City agree as follows:

ARTICLE I - Scope of Work

The Contractor agrees to furnish all of the materials, equipment and labor necessary; and to abide by all the duties and responsibilities applicable to it for the project titled "[Insert Title of Bid and a Bid Number]" in accordance with the requirements and provisions of the following documents, including all written modifications incorporated into any of the documents, which are incorporated as part of this Contract:

Non-discrimination and Living Wage
Declaration of Compliance Forms (if
applicable)
Vendor Conflict of Interest Form
Prevailing Wage Declaration of
Compliance Form (if applicable)
Bid Forms
Contract and Exhibits
Bonds

General Conditions
Standard Specifications
Detailed Specifications
Plans
Addenda

ARTICLE II - Definitions

The Public Services Area means the Project Management Services Unit

Project means **Broadway / N. Division / Detroit Street Planter Wall and Sidewalk Repair Project; City of Ann Arbor File No. 2015-024; ITB No. 4432**

ARTICLE III - Time of Completion

- (A) The work to be completed under this Contract shall begin immediately on the date specified in the Notice to Proceed issued by the City.
- (B) The entire work for this Contract shall be completed within 30 consecutive calendar days.
- (C) Failure to complete all the work within the time specified above, including any extension granted in writing by the Supervising Professional, shall obligate the Contractor to pay the City, as liquidated damages and not as a penalty, an amount equal to \$200.00 for each calendar day of delay in the completion of all the work. If any liquidated damages are unpaid by the Contractor, the City shall be entitled to deduct these unpaid liquidated damages from the monies due the Contractor.

The liquidated damages are for the non-quantifiable aspects of any of the previously identified events and do not cover actual damages that can be shown or quantified nor are they intended to preclude recovery of actual damages in addition to the recovery of liquidated damages.

ARTICLE IV - The Contract Sum

- (A) The City shall pay to the Contractor for the performance of the Contract, the unit prices as given in the Bid Form for the estimated bid total of:

_____ Dollars (\$_____)

- (B) The amount paid shall be equitably adjusted to cover changes in the work ordered by the Supervising Professional but not required by the Contract Documents. Increases or decreases shall be determined only by written agreement between the City and Contractor.

ARTICLE V - Assignment

This Contract may not be assigned or subcontracted any portion of any right or obligation under this contract without the written consent of the City. Notwithstanding any consent by the City to any assignment, Contractor shall at all times remain bound to all warranties, certifications, indemnifications, promises and performances, however described, as are required of it under this contract unless specifically released from the requirement, in writing, by the City.

ARTICLE VI - Choice of Law

This Contract shall be construed, governed, and enforced in accordance with the laws of the State of Michigan. By executing this agreement, the Contractor and the City agree to venue in a court of appropriate jurisdiction sitting within Washtenaw County for purposes of any action arising under this Contract. The parties stipulate that the venue referenced in this Contract is for convenience and waive any claim of non-convenience.

Whenever possible, each provision of the Contract will be interpreted in a manner as to be effective and valid under applicable law. The prohibition or invalidity, under applicable law, of any provision will not invalidate the remainder of the Contract.

ARTICLE VII - Relationship of the Parties

The parties of the Contract agree that it is not a Contract of employment but is a Contract to accomplish a specific result. Contractor is an independent Contractor performing services for the City. Nothing contained in this Contract shall be deemed to constitute any other relationship between the City and the Contractor.

Contractor certifies that it has no personal or financial interest in the project other than the compensation it is to receive under the Contract. Contractor certifies that it is not, and shall not become, overdue or in default to the City for any Contract, debt, or any other obligation to the City including real or personal property taxes. City shall have the right to set off any such debt against compensation awarded for services under this agreement.

ARTICLE VIII - Notice

All notices given under this Contract shall be in writing, and shall be by personal delivery or by certified mail with return receipt requested to the parties at their respective addresses as specified in the Contract Documents or other address the Contractor may specify in writing. Notice will be deemed given on the date when one of the following first occur: (1) the date of actual receipt; or (2) three days after mailing certified U.S. mail.

ARTICLE IX - Indemnification

To the fullest extent permitted by law, Contractor shall indemnify, defend and hold harmless the City, its officers, employees and agents harmless from all suits, claims, judgments and expenses including attorney’s fees resulting or alleged to result, in whole or in part, from any act or omission, which is in any way connected or associated with this Contract, by the Contractor or anyone acting on the Contractor’s behalf under this Contract. Contractor shall not be responsible to indemnify the City for losses or damages caused by or resulting from the City’s sole negligence. The provisions of this Article shall survive the expiration or earlier termination of this contract for any reason.

ARTICLE X - Entire Agreement

This Contract represents the entire understanding between the City and the Contractor and it supersedes all prior representations, negotiations, agreements, or understandings whether written or oral. Neither party has relied on any prior representations in entering into this Contract. No terms or conditions of either party’s invoice, purchase order or other administrative document shall modify the terms and conditions of this Contract, regardless of the other party’s failure to object to such form. This Contract shall be binding on and shall inure to the benefit of the parties to this Contract and their permitted successors and permitted assigns and nothing in this Contract, express or implied, is intended to or shall confer on any other person or entity any legal or equitable right, benefit, or remedy of any nature whatsoever under or by reason of this Contract. This Contract may be altered, amended or modified only by written amendment signed by the City and the Contractor.

FOR CONTRACTOR

By _____

Its: _____

FOR THE CITY OF ANN ARBOR

By _____
Christopher Taylor, Mayor

By _____
Jacqueline Beaudry, City Clerk

[signatures continue on next page]

Approved as to substance

By _____
Tom Crawford
Interim City Administrator

By _____
Craig A. Hupy, P.E.
Services Area Administrator

Approved as to form and content

Stephen K. Postema, City Attorney

PERFORMANCE BOND

- (1) _____ of _____ (referred to as "Principal"), and _____, a corporation duly authorized to do business in the State of Michigan (referred to as "Surety"), are bound to the City of Ann Arbor, Michigan (referred to as "City"), for \$ _____, the payment of which Principal and Surety bind themselves, their heirs, executors, administrators, successors and assigns, jointly and severally, by this bond.
- (2) The Principal has entered a written Contract with the City dated _____, 201_, for: _____ and _____ this bond is given for that Contract in compliance with Act No. 213 of the Michigan Public Acts of 1963, as amended, being MCL 129.201 et seq.
- (3) Whenever the Principal is declared by the City to be in default under the Contract, the Surety may promptly remedy the default or shall promptly:
- (a) complete the Contract in accordance with its terms and conditions; or
 - (b) obtain a bid or bids for submission to the City for completing the Contract in accordance with its terms and conditions, and upon determination by Surety of the lowest responsible bidder, arrange for a Contract between such bidder and the City, and make available, as work progresses, sufficient funds to pay the cost of completion less the balance of the Contract price; but not exceeding, including other costs and damages for which Surety may be liable hereunder, the amount set forth in paragraph 1.
- (4) Surety shall have no obligation to the City if the Principal fully and promptly performs under the Contract.
- (5) Surety agrees that no change, extension of time, alteration or addition to the terms of the Contract or to the work to be performed thereunder, or the specifications accompanying it shall in any way affect its obligations on this bond, and waives notice of any such change, extension of time, alteration or addition to the terms of the Contract or to the work, or to the specifications.

SIGNED AND SEALED this _____ day of _____, 201_.

(Name of Surety Company)

By _____
(Signature)

Its _____
(Title of Office)

Approved as to form:

Stephen K. Postema, City Attorney

(Name of Principal)

By _____
(Signature)

Its _____
(Title of Office)

Name and address of agent:

LABOR AND MATERIAL BOND

- (1) _____
of _____(referred to as "Principal"), and _____, a corporation duly authorized to do business in the State of Michigan, (referred to as "Surety"), are bound to the City of Ann Arbor, Michigan (referred to as "City"), for the use and benefit of claimants as defined in Act 213 of Michigan Public Acts of 1963, as amended, being MCL 129.201 et seq., in the amount of \$ _____, for the payment of which Principal and Surety bind themselves, their heirs, executors, administrators, successors and assigns, jointly and severally, by this bond.
- (2) The Principal has entered a written Contract with the City, dated _____, 201_, for _____; and this bond is given for that Contract in compliance with Act No. 213 of the Michigan Public Acts of 1963 as amended;
- (3) If the Principal fails to promptly and fully repay claimants for labor and material reasonably required under the Contract, the Surety shall pay those claimants.
- (4) Surety's obligations shall not exceed the amount stated in paragraph 1, and Surety shall have no obligation if the Principal promptly and fully pays the claimants.

SIGNED AND SEALED this _____ day of _____, 201_

(Name of Surety Company)
By _____
(Signature)
Its _____
(Title of Office)

(Name of Principal)
By _____
(Signature)
Its _____
(Title of Office)

Approved as to form:

Name and address of agent:

Stephen K. Postema, City Attorney

GENERAL CONDITIONS

Section 1 - Execution, Correlation and Intent of Documents

The contract documents shall be signed in 2 copies by the City and the Contractor.

The contract documents are complementary and what is called for by any one shall be binding. The intention of the documents is to include all labor and materials, equipment and transportation necessary for the proper execution of the work. Materials or work described in words which so applied have a well-known technical or trade meaning have the meaning of those recognized standards.

In case of a conflict among the contract documents listed below in any requirement(s), the requirement(s) of the document listed first shall prevail over any conflicting requirement(s) of a document listed later.

(1) Addenda in reverse chronological order; (2) Detailed Specifications; (3) Standard Specifications; (4) Plans; (5) General Conditions; (6) Contract; (7) Bid Forms; (8) Bond Forms; (9) Bid.

Section 2 - Order of Completion

The Contractor shall submit with each invoice, and at other times reasonably requested by the Supervising Professional, schedules showing the order in which the Contractor proposes to carry on the work. They shall include the dates at which the Contractor will start the several parts of the work, the estimated dates of completion of the several parts, and important milestones within the several parts.

Section 3 - Familiarity with Work

The Bidder or its representative shall make personal investigations of the site of the work and of existing structures and shall determine to its own satisfaction the conditions to be encountered, the nature of the ground, the difficulties involved, and all other factors affecting the work proposed under this Contract. The Bidder to whom this Contract is awarded will not be entitled to any additional compensation unless conditions are clearly different from those which could reasonably have been anticipated by a person making diligent and thorough investigation of the site.

The Bidder shall immediately notify the City upon discovery, and in every case prior to submitting its Bid, of every error or omission in the bidding documents that would be identified by a reasonably competent, diligent Bidder. In no case will a Bidder be allowed the benefit of extra compensation or time to complete the work under this Contract for extra expenses or time spent as a result of the error or omission.

Section 4 - Wage Requirements

Under this Contract, the Contractor shall conform to Chapter 14 of Title I of the Code of the City of Ann Arbor as amended; which in part states "...that all craftsmen, mechanics and laborers employed directly on the site in connection with said improvements, including said employees of subcontractors, shall receive the prevailing wage for the corresponding classes of craftsmen,

mechanics and laborers, as determined by statistics for the Ann Arbor area compiled by the United States Department of Labor. At the request of the City, any contractor or subcontractor shall provide satisfactory proof of compliance with the contract provisions required by the Section."

Where the Contract and the Ann Arbor City Ordinance are silent as to definitions of terms required in determining contract compliance with regard to prevailing wages, the definitions provided in the Davis-Bacon Act as amended (40 U.S.C. 278-a to 276-a-7) for the terms shall be used.

If the Contractor is a "covered employer" as defined in Chapter 23 of the Ann Arbor City Code, the Contractor agrees to comply with the living wage provisions of Chapter 23 of the Ann Arbor City Code. The Contractor agrees to pay those employees providing Services to the City under this Agreement a "living wage," as defined in Section 1:815 of the Ann Arbor City Code, as adjusted in accordance with Section 1:815(3); to post a notice approved by the City of the applicability of Chapter 23 in every location in which regular or contract employees providing services under this Agreement are working; to maintain records of compliance; if requested by the City, to provide documentation to verify compliance; to take no action that would reduce the compensation, wages, fringe benefits, or leave available to any employee or person contracted for employment in order to pay the living wage required by Section 1:815; and otherwise to comply with the requirements of Chapter 23.

Contractor agrees that all subcontracts entered into by the Contractor shall contain similar wage provision covering subcontractor's employees who perform work on this contract.

Section 5 - Non-Discrimination

The Contractor agrees to comply, and to require its subcontractor(s) to comply, with the nondiscrimination provisions of MCL 37.2209. The Contractor further agrees to comply with the provisions of Section 9:158 of Chapter 112 of Title IX of the Ann Arbor City Code, and to assure that applicants are employed and that employees are treated during employment in a manner which provides equal employment opportunity.

Section 6 - Materials, Appliances, Employees

Unless otherwise stipulated, the Contractor shall provide and pay for all materials, labor, water, tools, equipment, light, power, transportation, and other facilities necessary or used for the execution and completion of the work. Unless otherwise specified, all materials incorporated in the permanent work shall be new, and both workmanship and materials shall be of the highest quality. The Contractor shall, if required, furnish satisfactory evidence as to the kind and quality of materials.

The Contractor shall at all times enforce strict discipline and good order among its employees, and shall seek to avoid employing on the work any unfit person or anyone not skilled in the work assigned.

Adequate sanitary facilities shall be provided by the Contractor.

Section 7 - Qualifications for Employment

The Contractor shall employ competent laborers and mechanics for the work under this Contract. For work performed under this Contract, employment preference shall be given to qualified local residents.

Section 8 - Royalties and Patents

The Contractor shall pay all royalties and license fees. It shall defend all suits or claims for infringements of any patent rights and shall hold the City harmless from loss on account of infringement except that the City shall be responsible for all infringement loss when a particular process or the product of a particular manufacturer or manufacturers is specified, unless the City has notified the Contractor prior to the signing of the Contract that the particular process or product is patented or is believed to be patented.

Section 9 - Permits and Regulations

The Contractor must secure and pay for all permits, permit or plan review fees and licenses necessary for the prosecution of the work. These include but are not limited to City building permits, right-of-way permits, lane closure permits, right-of-way occupancy permits, and the like. The City shall secure and pay for easements shown on the plans unless otherwise specified.

The Contractor shall give all notices and comply with all laws, ordinances, rules and regulations bearing on the conduct of the work as drawn and specified. If the Contractor observes that the contract documents are at variance with those requirements, it shall promptly notify the Supervising Professional in writing, and any necessary changes shall be adjusted as provided in the Contract for changes in the work.

Section 10 - Protection of the Public and of Work and Property

The Contractor is responsible for the means, methods, sequences, techniques and procedures of construction and safety programs associated with the work contemplated by this contract. The Contractor, its agents or sub-contractors, shall comply with the "General Rules and Regulations for the Construction Industry" as published by the Construction Safety Commission of the State of Michigan and to all other local, State and National laws, ordinances, rules and regulations pertaining to safety of persons and property.

The Contractor shall take all necessary and reasonable precautions to protect the safety of the public. It shall continuously maintain adequate protection of all work from damage, and shall take all necessary and reasonable precautions to adequately protect all public and private property from injury or loss arising in connection with this Contract. It shall make good any damage, injury or loss to its work and to public and private property resulting from lack of reasonable protective precautions, except as may be due to errors in the contract documents, or caused by agents or employees of the City. The Contractor shall obtain and maintain sufficient insurance to cover damage to any City property at the site by any cause.

In an emergency affecting the safety of life, or the work, or of adjoining property, the Contractor is, without special instructions or authorization from the Supervising Professional, permitted to act at its discretion to prevent the threatened loss or injury. It shall also so act, without appeal, if authorized or instructed by the Supervising Professional.

Any compensation claimed by the Contractor for emergency work shall be determined by agreement or in accordance with the terms of Claims for Extra Cost - Section 15.

Section 11 - Inspection of Work

The City shall provide sufficient competent personnel for the inspection of the work.

The Supervising Professional shall at all times have access to the work whenever it is in preparation or progress, and the Contractor shall provide proper facilities for access and for inspection.

If the specifications, the Supervising Professional's instructions, laws, ordinances, or any public authority require any work to be specially tested or approved, the Contractor shall give the Supervising Professional timely notice of its readiness for inspection, and if the inspection is by an authority other than the Supervising Professional, of the date fixed for the inspection. Inspections by the Supervising Professional shall be made promptly, and where practicable at the source of supply. If any work should be covered up without approval or consent of the Supervising Professional, it must, if required by the Supervising Professional, be uncovered for examination and properly restored at the Contractor's expense.

Re-examination of any work may be ordered by the Supervising Professional, and, if so ordered, the work must be uncovered by the Contractor. If the work is found to be in accordance with the contract documents, the City shall pay the cost of re-examination and replacement. If the work is not in accordance with the contract documents, the Contractor shall pay the cost.

Section 12 - Superintendence

The Contractor shall keep on the work site, during its progress, a competent superintendent and any necessary assistants, all satisfactory to the Supervising Professional. The superintendent will be responsible to perform all on-site project management for the Contractor. The superintendent shall be experienced in the work required for this Contract. The superintendent shall represent the Contractor and all direction given to the superintendent shall be binding as if given to the Contractor. Important directions shall immediately be confirmed in writing to the Contractor. Other directions will be confirmed on written request. The Contractor shall give efficient superintendence to the work, using its best skill and attention.

Section 13 - Changes in the Work

The City may make changes to the quantities of work within the general scope of the Contract at any time by a written order and without notice to the sureties. If the changes add to or deduct from the extent of the work, the Contract Sum shall be adjusted accordingly. All the changes shall be executed under the conditions of the original Contract except that any claim for extension of time caused by the change shall be adjusted at the time of ordering the change.

In giving instructions, the Supervising Professional shall have authority to make minor changes in the work not involving extra cost and not inconsistent with the purposes of the work, but otherwise, except in an emergency endangering life or property, no extra work or change shall be made unless in pursuance of a written order by the Supervising Professional, and no claim for an addition to the Contract Sum shall be valid unless the additional work was ordered in writing.

The Contractor shall proceed with the work as changed and the value of the work shall be determined as provided in Claims for Extra Cost - Section 15.

Section 14 - Extension of Time

Extension of time stipulated in the Contract for completion of the work will be made if and as the Supervising Professional may deem proper under any of the following circumstances:

- (1) When work under an extra work order is added to the work under this Contract;
- (2) When the work is suspended as provided in Section 20;
- (3) When the work of the Contractor is delayed on account of conditions which could not have been foreseen, or which were beyond the control of the Contractor, and which

were not the result of its fault or negligence;

- (4) Delays in the progress of the work caused by any act or neglect of the City or of its employees or by other Contractors employed by the City;
- (5) Delay due to an act of Government;
- (6) Delay by the Supervising Professional in the furnishing of plans and necessary information;
- (7) Other cause which in the opinion of the Supervising Professional entitles the Contractor to an extension of time.

The Contractor shall notify the Supervising Professional within 7 days of an occurrence or conditions which, in the Contractor's opinion, entitle it to an extension of time. The notice shall be in writing and submitted in ample time to permit full investigation and evaluation of the Contractor's claim. The Supervising Professional shall acknowledge receipt of the Contractor's notice within 7 days of its receipt. Failure to timely provide the written notice shall constitute a waiver by the Contractor of any claim.

In situations where an extension of time in contract completion is appropriate under this or any other section of the contract, the Contractor understands and agrees that the only available adjustment for events that cause any delays in contract completion shall be extension of the required time for contract completion and that there shall be no adjustments in the money due the Contractor on account of the delay.

Section 15 - Claims for Extra Cost

If the Contractor claims that any instructions by drawings or other media issued after the date of the Contract involved extra cost under this Contract, it shall give the Supervising Professional written notice within 7 days after the receipt of the instructions, and in any event before proceeding to execute the work, except in emergency endangering life or property. The procedure shall then be as provided for Changes in the Work-Section 13. No claim shall be valid unless so made.

If the Supervising Professional orders, in writing, the performance of any work not covered by the contract documents, and for which no item of work is provided in the Contract, and for which no unit price or lump sum basis can be agreed upon, then the extra work shall be done on a Cost-Plus-Percentage basis of payment as follows:

- (1) The Contractor shall be reimbursed for all reasonable costs incurred in doing the work, and shall receive an additional payment of 15% of all the reasonable costs to cover both its indirect overhead costs and profit;
- (2) The term "Cost" shall cover all payroll charges for employees and supervision required under the specific order, together with all worker's compensation, Social Security, pension and retirement allowances and social insurance, or other regular payroll charges on same; the cost of all material and supplies required of either temporary or permanent character; rental of all power-driven equipment at agreed upon rates, together with cost of fuel and supply charges for the equipment; and any costs incurred by the Contractor as a direct result of executing the order, if approved by the Supervising Professional;
- (3) If the extra is performed under subcontract, the subcontractor shall be allowed to compute its charges as described above. The Contractor shall be permitted to add an additional charge of 5% percent to that of the subcontractor for the Contractor's

supervision and contractual responsibility;

- (4) The quantities and items of work done each day shall be submitted to the Supervising Professional in a satisfactory form on the succeeding day, and shall be approved by the Supervising Professional and the Contractor or adjusted at once;
- (5) Payments of all charges for work under this Section in any one month shall be made along with normal progress payments. Retainage shall be in accordance with Progress Payments-Section 16.

No additional compensation will be provided for additional equipment, materials, personnel, overtime or special charges required to perform the work within the time requirements of the Contract.

When extra work is required and no suitable price for machinery and equipment can be determined in accordance with this Section, the hourly rate paid shall be 1/40 of the basic weekly rate listed in the Rental Rate Blue Book published by Dataquest Incorporated and applicable to the time period the equipment was first used for the extra work. The hourly rate will be deemed to include all costs of operation such as bucket or blade, fuel, maintenance, "regional factors", insurance, taxes, and the like, but not the costs of the operator.

Section 16 - Progress Payments

The Contractor shall submit each month, or at longer intervals, if it so desires, an invoice covering work performed for which it believes payment, under the Contract terms, is due. The submission shall be to the City's Finance Department - Accounting Division. The Supervising Professional will, within 10 days following submission of the invoice, prepare a certificate for payment for the work in an amount to be determined by the Supervising Professional as fairly representing the acceptable work performed during the period covered by the Contractor's invoice. To insure the proper performance of this Contract, the City will retain a percentage of the estimate in accordance with Act 524, Public Acts of 1980. The City will then, following the receipt of the Supervising Professional's Certificate, make payment to the Contractor as soon as feasible, which is anticipated will be within 15 days.

An allowance may be made in progress payments if substantial quantities of permanent material have been delivered to the site but not incorporated in the completed work if the Contractor, in the opinion of the Supervising Professional, is diligently pursuing the work under this Contract. Such materials shall be properly stored and adequately protected. Allowance in the estimate shall be at the invoice price value of the items. Notwithstanding any payment of any allowance, all risk of loss due to vandalism or any damages to the stored materials remains with the Contractor.

In the case of Contracts which include only the Furnishing and Delivering of Equipment, the payments shall be; 60% of the Contract Sum upon the delivery of all equipment to be furnished, or in the case of delivery of a usable portion of the equipment in advance of the total equipment delivery, 60% of the estimated value of the portion of the equipment may be paid upon its delivery in advance of the time of the remainder of the equipment to be furnished; 30% of the Contract Sum upon completion of erection of all equipment furnished, but not later than 60 days after the date of delivery of all of the equipment to be furnished; and payment of the final 10% on final completion of erection, testing and acceptance of all the equipment to be furnished; but not later than 180 days after the date of delivery of all of the equipment to be furnished, unless testing has been completed and shows the equipment to be unacceptable.

With each invoice for periodic payment, the Contractor shall enclose a Contractor's Declaration - Section 43, and an updated project schedule per Order of Completion - Section 2.

Section 17 - Deductions for Uncorrected Work

If the Supervising Professional decides it is inexpedient to correct work that has been damaged or that was not done in accordance with the Contract, an equitable deduction from the Contract price shall be made.

Section 18 - Correction of Work Before Final Payment

The Contractor shall promptly remove from the premises all materials condemned by the Supervising Professional as failing to meet Contract requirements, whether incorporated in the work or not, and the Contractor shall promptly replace and re-execute the work in accordance with the Contract and without expense to the City and shall bear the expense of making good all work of other contractors destroyed or damaged by the removal or replacement.

If the Contractor does not remove the condemned work and materials within 10 days after written notice, the City may remove them and, if the removed material has value, may store the material at the expense of the Contractor. If the Contractor does not pay the expense of the removal within 10 days thereafter, the City may, upon 10 days written notice, sell the removed materials at auction or private sale and shall pay to the Contractor the net proceeds, after deducting all costs and expenses that should have been borne by the Contractor. If the removed material has no value, the Contractor must pay the City the expenses for disposal within 10 days of invoice for the disposal costs.

The inspection or lack of inspection of any material or work pertaining to this Contract shall not relieve the Contractor of its obligation to fulfill this Contract and defective work shall be made good. Unsuitable materials may be rejected by the Supervising Professional notwithstanding that the work and materials have been previously overlooked by the Supervising Professional and accepted or estimated for payment or paid for. If the work or any part shall be found defective at any time before the final acceptance of the whole work, the Contractor shall forthwith make good the defect in a manner satisfactory to the Supervising Professional. The judgment and the decision of the Supervising Professional as to whether the materials supplied and the work done under this Contract comply with the requirements of the Contract shall be conclusive and final.

Section 19 - Acceptance and Final Payment

Upon receipt of written notice that the work is ready for final inspection and acceptance, the Supervising Professional will promptly make the inspection. When the Supervising Professional finds the work acceptable under the Contract and the Contract fully performed, the Supervising Professional will promptly sign and issue a final certificate stating that the work required by this Contract has been completed and is accepted by the City under the terms and conditions of the Contract. The entire balance found to be due the Contractor, including the retained percentage, shall be paid to the Contractor by the City within 30 days after the date of the final certificate.

Before issuance of final certificates, the Contractor shall file with the City:

- (1) The consent of the surety to payment of the final estimate;
- (2) The Contractor's Affidavit in the form required by Section 44.

In case the Affidavit or consent is not furnished, the City may retain out of any amount due the Contractor, sums sufficient to cover all lienable claims.

The making and acceptance of the final payment shall constitute a waiver of all claims by the City except those arising from:

- (1) unsettled liens;

- (2) faulty work appearing within 12 months after final payment;
- (3) hidden defects in meeting the requirements of the plans and specifications;
- (4) manufacturer's guarantees.

It shall also constitute a waiver of all claims by the Contractor, except those previously made and still unsettled.

Section 20 - Suspension of Work

The City may at any time suspend the work, or any part by giving 5 days notice to the Contractor in writing. The work shall be resumed by the Contractor within 10 days after the date fixed in the written notice from the City to the Contractor to do so. The City shall reimburse the Contractor for expense incurred by the Contractor in connection with the work under this Contract as a result of the suspension.

If the work, or any part, shall be stopped by the notice in writing, and if the City does not give notice in writing to the Contractor to resume work at a date within 90 days of the date fixed in the written notice to suspend, then the Contractor may abandon that portion of the work suspended and will be entitled to the estimates and payments for all work done on the portions abandoned, if any, plus 10% of the value of the work abandoned, to compensate for loss of overhead, plant expense, and anticipated profit.

Section 21 - Delays and the City's Right to Terminate Contract

If the Contractor refuses or fails to prosecute the work, or any separate part of it, with the diligence required to insure completion, ready for operation, within the allowable number of consecutive calendar days specified plus extensions, or fails to complete the work within the required time, the City may, by written notice to the Contractor, terminate its right to proceed with the work or any part of the work as to which there has been delay. After providing the notice the City may take over the work and prosecute it to completion, by contract or otherwise, and the Contractor and its sureties shall be liable to the City for any excess cost to the City. If the Contractor's right to proceed is terminated, the City may take possession of and utilize in completing the work, any materials, appliances and plant as may be on the site of the work and useful for completing the work. The right of the Contractor to proceed shall not be terminated or the Contractor charged with liquidated damages where an extension of time is granted under Extension of Time - Section 14.

If the Contractor is adjudged a bankrupt, or if it makes a general assignment for the benefit of creditors, or if a receiver is appointed on account of its insolvency, or if it persistently or repeatedly refuses or fails except in cases for which extension of time is provided, to supply enough properly skilled workers or proper materials, or if it fails to make prompt payments to subcontractors or for material or labor, or persistently disregards laws, ordinances or the instructions of the Supervising Professional, or otherwise is guilty of a substantial violation of any provision of the Contract, then the City, upon the certificate of the Supervising Professional that sufficient cause exists to justify such action, may, without prejudice to any other right or remedy and after giving the Contractor 3 days written notice, terminate this Contract. The City may then take possession of the premises and of all materials, tools and appliances thereon and without prejudice to any other remedy it may have, make good the deficiencies or finish the work by whatever method it may deem expedient, and deduct the cost from the payment due the Contractor. The Contractor shall not be entitled to receive any further payment until the work is finished. If the expense of finishing the work, including compensation for additional managerial and administrative services exceeds the unpaid balance of the Contract Sum, the Contractor and its surety are liable to the City for any excess cost incurred. The expense incurred by the City, and the damage incurred through the Contractor's default, shall be certified by the Supervising Professional.

Section 22 - Contractor's Right to Terminate Contract

If the work should be stopped under an order of any court, or other public authority, for a period of 3 months, through no act or fault of the Contractor or of anyone employed by it, then the Contractor may, upon 7 days written notice to the City, terminate this Contract and recover from the City payment for all acceptable work executed plus reasonable profit.

Section 23 - City's Right To Do Work

If the Contractor should neglect to prosecute the work properly or fail to perform any provision of this Contract, the City, 3 days after giving written notice to the Contractor and its surety may, without prejudice to any other remedy the City may have, make good the deficiencies and may deduct the cost from the payment due to the Contractor.

Section 24 - Removal of Equipment and Supplies

In case of termination of this Contract before completion, from any or no cause, the Contractor, if notified to do so by the City, shall promptly remove any part or all of its equipment and supplies from the property of the City, failing which the City shall have the right to remove the equipment and supplies at the expense of the Contractor.

The removed equipment and supplies may be stored by the City and, if all costs of removal and storage are not paid by the Contractor within 10 days of invoicing, the City upon 10 days written notice may sell the equipment and supplies at auction or private sale, and shall pay the Contractor the net proceeds after deducting all costs and expenses that should have been borne by the Contractor and after deducting all amounts claimed due by any lien holder of the equipment or supplies.

Section 25 - Responsibility for Work and Warranties

The Contractor assumes full responsibility for any and all materials and equipment used in the construction of the work and may not make claims against the City for damages to materials and equipment from any cause except negligence or willful act of the City. Until its final acceptance, the Contractor shall be responsible for damage to or destruction of the project (except for any part covered by Partial Completion and Acceptance - Section 26). The Contractor shall make good all work damaged or destroyed before acceptance. All risk of loss remains with the Contractor until final acceptance of the work (Section 19) or partial acceptance (Section 26). The Contractor is advised to investigate obtaining its own builders risk insurance.

The Contractor shall guarantee the quality of the work for a period of one year. The Contractor shall also unconditionally guarantee the quality of all equipment and materials that are furnished and installed under the contract for a period of one year. At the end of one year after the Contractor's receipt of final payment, the complete work, including equipment and materials furnished and installed under the contract, shall be inspected by the Contractor and the Supervising Professional. Any defects shall be corrected by the Contractor at its expense as soon as practicable but in all cases within 60 days. Any defects that are identified prior to the end of one year shall also be inspected by the Contractor and the Supervising Professional and shall be corrected by the Contractor at its expense as soon as practicable but in all cases within 60 days.

The Contractor shall assign all manufacturer or material supplier warranties to the City prior to final payment. The assignment shall not relieve the Contractor of its obligations under this paragraph to correct defects.

Section 26 - Partial Completion and Acceptance

If at any time prior to the issuance of the final certificate referred to in Acceptance and Final Payment - Section 19, any portion of the permanent construction has been satisfactorily completed, and if the Supervising Professional determines that portion of the permanent construction is not required for the operations of the Contractor but is needed by the City, the Supervising Professional shall issue to the Contractor a certificate of partial completion, and immediately the City may take over and use the portion of the permanent construction described in the certificate, and exclude the Contractor from that portion.

The issuance of a certificate of partial completion shall not constitute an extension of the Contractor's time to complete the portion of the permanent construction to which it relates if the Contractor has failed to complete it in accordance with the terms of this Contract. The issuance of the certificate shall not release the Contractor or its sureties from any obligations under this Contract including bonds.

If prior use increases the cost of, or delays the work, the Contractor shall be entitled to extra compensation, or extension of time, or both, as the Supervising Professional may determine.

Section 27 - Payments Withheld Prior to Final Acceptance of Work

The City may withhold or, on account of subsequently discovered evidence, nullify the whole or part of any certificate to the extent reasonably appropriate to protect the City from loss on account of:

- (1) Defective work not remedied;
- (2) Claims filed or reasonable evidence indicating probable filing of claims by other parties against the Contractor;
- (3) Failure of the Contractor to make payments properly to subcontractors or for material or labor;
- (4) Damage to another Contractor.

When the above grounds are removed or the Contractor provides a Surety Bond satisfactory to the City which will protect the City in the amount withheld, payment shall be made for amounts withheld under this section.

Section 28 - Contractor's Insurance

- (1) The Contractor shall procure and maintain during the life of this Contract, including the guarantee period and during any warranty work, such insurance policies, including those set forth below, as will protect itself and the City from all claims for bodily injuries, death or property damage which may arise under this Contract; whether the act(s) or omission(s) giving rise to the claim were made by the Contractor or by any subcontractor or anyone employed by them directly or indirectly. In the case of all contracts involving on-site work, the Contractor shall provide to the City, before the commencement of any work under this contract, certificates of insurance and other documentation satisfactory to the City demonstrating it has obtained the policies and endorsements required on behalf of itself, and when requested, any subcontractor(s). The certificates of insurance endorsements and/or copies of policy language shall document that the Contractor satisfies the following minimum requirements.

- (a) Worker's Compensation Insurance in accordance with all applicable state and federal statutes. Further, Employers Liability Coverage shall be obtained in the following minimum amounts:

Bodily Injury by Accident - \$500,000 each accident
Bodily Injury by Disease - \$500,000 each employee
Bodily Injury by Disease - \$500,000 each policy limit

- (b) Commercial General Liability Insurance equivalent to, as a minimum, Insurance Services Office form CG 00 01 07 98 or current equivalent. The City of Ann Arbor shall be named as an additional insured. There shall be no added exclusions or limiting endorsements specifically for the following coverages: Products and Completed Operations, Explosion, Collapse and Underground coverage or Pollution. Further there shall be no added exclusions or limiting endorsements which diminish the City's protections as an additional insured under the policy. The following minimum limits of liability are required:

| | |
|-------------|--|
| \$1,000,000 | Each occurrence as respect Bodily Injury Liability or Property Damage Liability, or both combined. |
| \$2,000,000 | Per Job General Aggregate |
| \$1,000,000 | Personal and Advertising Injury |
| \$2,000,000 | Products and Completed Operations Aggregate |

- (c) Motor Vehicle Liability Insurance, including Michigan No-Fault Coverages, equivalent to, as a minimum, Insurance Services Office form CA 00 01 07 97 or current equivalent. Coverage shall include all owned vehicles, all non-owned vehicles and all hired vehicles. The City of Ann Arbor shall be named as an additional insured. There shall be no added exclusions or limiting endorsements which diminish the City's protections as an additional insured under the policy. Further, the limits of liability shall be \$1,000,000 for each occurrence as respects Bodily Injury Liability or Property Damage Liability, or both combined.

- (d) Umbrella/Excess Liability Insurance shall be provided to apply excess of the Commercial General Liability, Employers Liability and the Motor Vehicle coverage enumerated above, for each occurrence and for aggregate in the amount of \$1,000,000.

- (2) Insurance required under subsection (1)(b) and (1)(c) above shall be considered primary as respects any other valid or collectible insurance that the City may possess, including any self-insured retentions the City may have; and any other insurance the City does possess shall be considered excess insurance only and shall not be required to contribute with this insurance. Further, the Contractor agrees to waive any right of recovery by its insurer against the City.

- (3) Insurance companies and policy forms are subject to approval of the City Attorney, which approval shall not be unreasonably withheld. Documentation must provide and demonstrate an unconditional 30 day written notice of cancellation in favor of the City of Ann Arbor. Further, the documentation must explicitly state the following: (a) the policy number; name of insurance company; name and address of the agent or authorized representative; name and address of insured; project name; policy expiration date; and specific coverage amounts; (b) any deductibles or self-insured retentions which shall be approved by the City, in its sole discretion; (c) that the policy conforms to the requirements specified. Contractor shall furnish the City with satisfactory certificates of insurance and endorsements prior to commencement of any work. Upon request, the Contractor shall provide within 30 days a copy of the policy(ies) to the City. If any of the above coverages expire by their terms during the term of this Contract, the Contractor shall deliver proof of renewal and/or new policies and endorsements to the Administering

Service Area/Unit at least ten days prior to the expiration date.

- (4) Any Insurance provider of Contractor shall be admitted and authorized to do business in the State of Michigan and shall carry and maintain a minimum rating assigned by A.M. Best & Company's Key Rating Guide of "A-" Overall and a minimum Financial Size Category of "V". Insurance policies and certificates issued by non-admitted insurance companies are not acceptable unless approved in writing by the City.
- (5) City reserves the right to require additional coverage and/or coverage amounts as may be included from time to time in the Detailed Specifications for the Project.
- (6) The provisions of General Condition 28 shall survive the expiration or earlier termination of this contract for any reason.

Section 29 - Surety Bonds

Bonds will be required from the successful bidder as follows:

- (1) A Performance Bond to the City of Ann Arbor for the amount of the bid(s) accepted;
- (2) A Labor and Material Bond to the City of Ann Arbor for the amount of the bid(s) accepted.

Bonds shall be executed on forms supplied by the City in a manner and by a Surety Company authorized to transact business in Michigan and satisfactory to the City Attorney.

Section 30 - Damage Claims

The Contractor shall be held responsible for all damages to property of the City or others, caused by or resulting from the negligence of the Contractor, its employees, or agents during the progress of or connected with the prosecution of the work, whether within the limits of the work or elsewhere. The Contractor must restore all property injured including sidewalks, curbing, sodding, pipes, conduit, sewers or other public or private property to not less than its original condition with new work.

Section 31 - Refusal to Obey Instructions

If the Contractor refuses to obey the instructions of the Supervising Professional, the Supervising Professional shall withdraw inspection from the work, and no payments will be made for work performed thereafter nor may work be performed thereafter until the Supervising Professional shall have again authorized the work to proceed.

Section 32 - Assignment

Neither party to the Contract shall assign the Contract without the written consent of the other. The Contractor may assign any monies due to it to a third party acceptable to the City.

Section 33 - Rights of Various Interests

Whenever work being done by the City's forces or by other contractors is contiguous to work covered by this Contract, the respective rights of the various interests involved shall be established by the Supervising Professional, to secure the completion of the various portions of the work in general harmony.

The Contractor is responsible to coordinate all aspects of the work, including coordination of,

and with, utility companies and other contractors whose work impacts this project.

Section 34 - Subcontracts

The Contractor shall not award any work to any subcontractor without prior written approval of the City. The approval will not be given until the Contractor submits to the City a written statement concerning the proposed award to the subcontractor. The statement shall contain all information the City may require.

The Contractor shall be as fully responsible to the City for the acts and omissions of its subcontractors, and of persons either directly or indirectly employed by them, as it is for the acts and omissions of persons directly employed by it.

The Contractor shall cause appropriate provisions to be inserted in all subcontracts relative to the work to bind subcontractors to the Contractor by the terms of the General Conditions and all other contract documents applicable to the work of the subcontractors and to give the Contractor the same power to terminate any subcontract that the City may exercise over the Contractor under any provision of the contract documents.

Nothing contained in the contract documents shall create any contractual relation between any subcontractor and the City.

Section 35 - Supervising Professional's Status

The Supervising Professional has the right to inspect any or all work. The Supervising Professional has authority to stop the work whenever stoppage may be appropriate to insure the proper execution of the Contract. The Supervising Professional has the authority to reject all work and materials which do not conform to the Contract and to decide questions which arise in the execution of the work.

The Supervising Professional shall make all measurements and determinations of quantities. Those measurements and determinations are final and conclusive between the parties.

Section 36 - Supervising Professional's Decisions

The Supervising Professional shall, within a reasonable time after their presentation to the Supervising Professional, make decisions in writing on all claims of the City or the Contractor and on all other matters relating to the execution and progress of the work or the interpretation of the contract documents.

Section 37 - Storing Materials and Supplies

Materials and supplies may be stored at the site of the work at locations agreeable to the City unless specific exception is listed elsewhere in these documents. Ample way for foot traffic and drainage must be provided, and gutters must, at all times, be kept free from obstruction. Traffic on streets shall be interfered with as little as possible. The Contractor may not enter or occupy with agents, employees, tools, or material any private property without first obtaining written permission from its owner. A copy of the permission shall be furnished to the Supervising Professional.

Section 38 - Lands for Work

The Contractor shall provide, at its own expense and without liability to the City, any additional land and access that may be required for temporary construction facilities or for storage of materials.

Section 39 - Cleaning Up

The Contractor shall, as directed by the Supervising Professional, remove at its own expense from the City's property and from all public and private property all temporary structures, rubbish and waste materials resulting from its operations unless otherwise specifically approved, in writing, by the Supervising Professional.

Section 40 - Salvage

The Supervising Professional may designate for salvage any materials from existing structures or underground services. Materials so designated remain City property and shall be transported or stored at a location as the Supervising Professional may direct.

Section 41 - Night, Saturday or Sunday Work

No night or Sunday work (without prior written City approval) will be permitted except in the case of an emergency and then only to the extent absolutely necessary. The City may allow night work which, in the opinion of the Supervising Professional, can be satisfactorily performed at night. Night work is any work between 8:00 p.m. and 7:00 a.m. No Saturday work will be permitted unless the Contractor gives the Supervising Professional at least 48 hours but not more than 5 days notice of the Contractor's intention to work the upcoming Saturday.

Section 42 - Sales Taxes

Under State law the City is exempt from the assessment of State Sales Tax on its direct purchases. Contractors who acquire materials, equipment, supplies, etc. for incorporation in City projects are not likewise exempt. State Law shall prevail. The Bidder shall familiarize itself with the State Law and prepare its Bid accordingly. No extra payment will be allowed under this Contract for failure of the Contractor to make proper allowance in this bid for taxes it must pay.

Section 43

CONTRACTOR'S DECLARATION

I hereby declare that I have not, during the period _____, 20____, to _____, 20____, performed any work, furnished any materials, sustained any loss, damage or delay, or otherwise done anything in addition to the regular items (or executed change orders) set forth in the Contract titled _____, for which I shall ask, demand, sue for, or claim compensation or extension of time from the City, except as I hereby make claim for additional compensation or extension of time as set forth on the attached itemized statement. I further declare that I have paid all payroll obligations related to this Contract that have become due during the above period and that all invoices related to this Contract received more than 30 days prior to this declaration have been paid in full except as listed below.

There is/is not (Contractor please circle one and strike one as appropriate) an itemized statement attached regarding a request for additional compensation or extension of time.

Contractor

Date

By _____
(Signature)

Its _____
(Title of Office)

Past due invoices, if any, are listed below.

STANDARD SPECIFICATIONS

All work under this contract shall be performed in accordance with the Public Services Department Standard Specifications in effect at the date of availability of the contract documents stipulated in the Bid. All work under this Contract which is not included in these Standard Specifications, or which is performed using modifications to these Standard Specifications, shall be performed in accordance with the Detailed Specifications included in these contract documents.

Standard Specifications are available online:

<http://www.a2gov.org/departments/engineering/Pages/Engineering-and-Contractor-Resources.aspx>

DETAILED SPECIFICATIONS

CITY OF ANN ARBOR
DETAILED SPECIFICATION
FOR
ALKALI-SILICA REACTIVITY (ASR) IN CONCRETE

FTCH/VDG:COAA

1 of 4

01/2016

Description

- A. The Contractor shall provide portland cement concrete mixtures for the project that are resistant to excessive expansion caused by alkali-silica reactivity (ASR).
- B. The evaluation as to the resistance of submitted concrete mixtures to excessive expansion caused by ASR shall be by the Owner as described herein.

Related Sections

- A. This Special Provision is supplemental to all other sections within the specifications of the Contract related to the construction of concrete items for the project.

Submittals

- A. One week after the Owner awards this project, the Contractor shall submit to the Owner all proposed concrete mix designs. These shall include the following:
 - 1. Sources for all fine and coarse aggregates proposed to be used identified by their Michigan Department of Transportation A.S.I # as listed in the Qualified Products List from the current Michigan Department of Transportation Materials Source Guide, if applicable, or by an identifiable name if not applicable.
 - 2. Sources and recent mill test reports for all cementitious materials and supplementary cementitious materials proposed to be used.
- B. The Contractor also may submit for consideration the following:
 - 1. ASTM C 1260 (Potential Alkali Reactivity of Aggregates (Mortar-Bar Method)) test results for the fine and /or coarse aggregates indicated on the proposed concrete mix designs.
 - 2. ASTM C 1567 (Determining the Potential Alkali Reactivity of Combinations of Cementitious Materials and Aggregate (Accelerated Mortar-Bar Method)) test results for the specific proportionate combinations of cementitious, supplementary cementitious, fine, and coarse aggregate materials indicated on the proposed concrete mix designs.
 - 3. ASTM C 1293 (Determination of Length Change of Concrete Due to Alkali-Silica Reaction) test results for the fine and/or coarse aggregates indicated on the proposed concrete mix designs.

CITY OF ANN ARBOR
DETAILED SPECIFICATION
FOR
ALKALI-SILICA REACTIVITY (ASR) IN CONCRETE

FTCH/VDG:COAA

2 of 4

01/2016

References

- A. Portland Cement ASTM C 150
- B. Fine Aggregate ASTM C 33
- C. Coarse Aggregate ASTM C 33
- D. Ground Granulated Blast Furnace Slag, Grade 100, 120 ASTM C 989

Quality Assurance

- A. The Engineer shall review the submitted information and testing data submitted with the proposed concrete mixtures and any information and/or any test results with respect to ASR the Engineer has on record for the proposed aggregates and/or proportionate combinations of cementitious materials and aggregates.
 - 1. The criteria for approval of a proposed concrete mixture for resistance to excessive expansion caused by ASR shall be as follows:
 - a. If a proposed concrete mixture contains cement with an alkali level of less than 0.60% expressed as equivalent sodium oxide (percent $\text{Na}_2\text{O} + 0.658 \times$ percent K_2O) the mixture shall be considered to be resistant to the potential for excessive expansion caused by ASR.
 - 1.) The determination of the alkali level of the proposed cement shall be made from the mill test reports submitted per Section 1.03.
 - b. If a proposed concrete mixture contains both fine and coarse aggregates for which there is testing per ASTM C 1260 that shows that both the fine and coarse aggregates produce expansions of less than 0.10%, the fine or coarse aggregate used to construct the mortar bar shall be considered to be “innocuous” (per Appendix X1 of ASTM C-33). Concrete mixtures that include both fine and coarse aggregates considered to be innocuous shall be considered to be resistant to excessive expansion caused by ASR.
 - c. If a proposed concrete mixture for which there is previous testing per ASTM C 1567, shows the proposed combination of cementitious materials and aggregates produce expansions of less than 0.10% the mixture shall be considered to be resistant to excessive expansion caused by ASR.
 - d. If a proposed concrete mixture for which there is previous testing per ASTM C 1293 shows that both the fine and coarse aggregates meets the criteria of Appendix XI of ASTM C 1293 with respect to the non-reactivity of the aggregate, the mixtures shall be considered to be resistant to excessive expansion caused by ASR.

CITY OF ANN ARBOR
DETAILED SPECIFICATION
FOR
ALKALI-SILICA REACTIVITY (ASR) IN CONCRETE

FTCH/VDG:COAA

3 of 4

01/2016

- e. If, based on the Engineer's evaluation, additional testing of the fine and/or coarse aggregates is needed to make the evaluations as discussed herein; the Owner shall perform such testing.
 - 1.) The Owner shall have access to all materials, including aggregate pits, in order to obtain samples for such additional testing.
 - 2.) The Owner shall perform the following test using the fine and/or coarse aggregates proposed for each concrete mixture: ASTM C 1260 – Standard Test Method for Potential Alkali Reactivity of Aggregates (Mortar – Bar Method).
 - 3.) All samples submitted for testing per ASTM C 1260 shall first be tested to establish conformance to the required material specification for gradation.
 - 4.) All samples submitted shall meet the required material specification for gradation prior to being submitted for testing per ASTM C1260.
2. If, based on the Engineer's evaluation, the submitted concrete mixture does not meet any one of the criteria of 1.05A.1. the mixture shall be rejected or be mitigated by Methods 1 or 2 as follows:
 - a. Method 1 - Use of a cement with an alkali level of less than 0.60% expressed as equivalent sodium oxide (percent Na₂O + 0.658 x percent K₂O).
 - 1.) The determination of the alkali level of the proposed cement shall be made from the mill test reports submitted per Section 1.03.
 - b. Method 2 - Substitution of a portion of the cement with Ground Granulated Blast Furnace Slag (GGBFS) Grade 100 or 120 (ASTM C 689).
 - 1.) For Method 2, the maximum substitution of cement with the GGBFS permitted shall be 35% by weight of total cementitious material (cement plus GGBFS).
 - 2.) For Method 2, the effectiveness of the proposed cement–GGBFS combination to resist the potential for excessive expansion caused by ASR for each aggregate that is considered to be potentially reactive shall be demonstrated.
 - 3.) The effectiveness of the proposed cement–GGBFS combination shall be based on test mortar bars per ASTM C 1260 using each fine or coarse aggregate that has been considered to be potentially reactive and the proposed cement-GGBFS combination for the concrete mixture.

CITY OF ANN ARBOR
DETAILED SPECIFICATION
FOR
ALKALI-SILICA REACTIVITY (ASR) IN CONCRETE

FTCH/VDG:COAA

4 of 4

01/2016

- 4.) The criteria for evaluating the mitigation of a proposed concrete mixture with respect to ASR by Method 2 shall be as follows:
 - a.) If a mortar bar constructed of an aggregate that is considered to be potentially reactive and the proposed cement-GGBFS combination produces an expansion of less than 0.10%, the aggregate and proposed cement-GGBFS combination shall be considered to be resistant to excessive expansion caused by ASR.
 - b.) Concrete mixtures that include both fine and coarse aggregates considered to be resistant to excessive expansion caused by ASR by mitigation Method 2 as described herein shall be considered to have been adequately mitigated with respect to and resistant to excessive expansion caused by ASR.
 - c.) If a mortar bar constructed of an aggregate that is considered to be potentially reactive and the proposed cement-GGBFS combination produces an expansion of 0.10% or greater, concrete mixtures containing these materials shall not be considered resistant to the potential for excessive expansion caused by ASR and the concrete mixture shall be rejected.
- c. The contractor shall be responsible for all costs associated with the mitigation of a concrete mixture for ASR and any delay costs incurred from the Owner if, due to the mitigation method selected by the Contractor, it takes the Contractor beyond their completion dates.
- B. If the Contractor intends to change suppliers, or if the supplier intends to change concrete mixtures after the evaluation and/or Mortar-Bar tests are performed, the Contractor shall inform the Owner immediately, but not less than forty-five (45) days prior to concrete batching.
 1. Upon notification, all concrete work will be postponed, without any additional costs or extension of time allowed by the Owner, until evaluation of the new mixtures and testing of the new materials, if needed, has been completed.
- C. The Owner will be testing the concrete that is delivered to the project site so as to insure that the approved mix design is being followed.
 1. To assist the Owner in establishing that the approved mix design is being followed, the supplier shall include on the delivery ticket for each batch of concrete delivered to the job, the identification and proportions of each material batched.

CITY OF ANN ARBOR

DETAILED SPECIFICATION
FOR
CONCRETE CURB HEAD

FTCH/VDG:COAA

1 of 1

03/2016

a. Description.- This work shall consist of removing the top portion of existing concrete curb down to elevation flush with the gutter line, adding reinforcing steel including adhesive anchoring, and forming and placing new concrete curb head as shown on drawings and this Detailed Specification.

b. Materials.- Concrete for curb reconstruction shall be Grade P1 in accordance with Section 601 of the 2012 MDOT Standard Specifications for Construction.

c. Construction.-

1. Forming and constructing of concrete curb head shall be performed in accordance with Section 802 of the 2012 MDOT Standard Specifications for Construction.
2. The shape of the curb head shall match that of MDOT Standard Plan R-30 Series, F-Type.

d. Measurement and Payment.- The work and materials to prepare the concrete surface, form, place steel reinforcement and concrete to reconstruct the concrete curb head will be paid for, measured along its length, at the contract unit price for the following pay item:

Concrete Curb Head.....Foot

CITY OF ANN ARBOR
DETAILED SPECIFICATION
FOR
CONCRETE SIDEWALK AND ADA RAMPS

FTCH/VDG:AA/MGN

1 of 3

02/01/16

a. Description.- This work shall consist of constructing concrete sidewalk and sidewalk ramps of the types as indicated on the plan sheets, as detailed in the specifications, or as directed by the Engineer. All work shall be in accordance with Section 801 and 803 of the 2012 MDOT Standard Specifications for Construction and as specified herein.

All ADA ramps shall be installed with detectable warning units. Reference the Special Provision entitled "Detectable Warning Tiles" for additional requirements.

b. Materials.- The materials shall meet the requirements as specified in the 2012 MDOT Standard Specifications and as required herein. The grade of concrete for all sidewalk and ramp items covered by this Special Provision shall be grade P1 as specified in Section 601 of the 2012 MDOT Standard Specifications for Construction. The Contractor may elect to add GGBFS to P1 mixtures in accordance with the requirements of the contract documents. No additional payment will be made for concrete mixtures containing GGBFS.

All concrete mixtures shall contain 6AA coarse aggregates which are either natural or limestone and meet the requirements of Section 902 of the 2012 Michigan Department of Transportation Standard Specifications for Construction.

It shall be the Contractor's sole responsibility to propose specific concrete mix designs which meet the requirements of this Special Provision.

c. Construction Methods.- The Contractor is responsible to construct all sidewalk, sidewalk ramps, curbs, and all other concrete items within ADAAG compliance. All sidewalk and curb ramps must be constructed in accordance with MDOT Standard Detail R-28-I (or the version in effect at the time of Bid Letting.)

Where concrete sidewalk and/or ADA compliant ramps are to be placed, they shall be placed on a minimum of 4 inches of Granular Material, Class II, compacted to 95% of its maximum dry density.

Concrete drive approaches shall be placed on either aggregate base course or a sand sub-base as shown on the plans or as directed by the Engineer. The required density of the material underlying the concrete drive approach shall be that of the material on which it is placed and required by those specifications.

CITY OF ANN ARBOR
DETAILED SPECIFICATION
FOR
CONCRETE SIDEWALK AND ADA RAMPS

FTCH/VDG:AA/MGN

2 of 3

02/01/16

Prior to placing any concrete, the subgrade shall be completed and trimmed to final elevation. If a cold joint is required, the existing concrete is to be cleaned with compressed air to expose the aggregate in the concrete.

Where indicated on the plans to be performed, the Contractor shall also horizontally sawcut curbs to provide openings for sidewalk ramps as indicated. The Engineer shall define the extent of sawcutting both horizontally and vertically. This work will not be paid for separately, but shall be included in the corresponding price of the ADA ramp to be placed.

The concrete items being placed shall not be opened to construction or vehicular traffic until such time as the concrete has reached the required flexural strength. The Contractor shall cast beams in accordance with Section 603.03.B.10, and as approved by the Engineer, and obtain concrete flexural strength in accordance with the requirements of Section 104.11, Table 104-2. Beams cast for open to traffic determinations shall be cured in the same manner and environment as the concrete items which they represent.

Flexural strength beams shall be tested (broken) with a device meeting the approval of the Engineer and be in a state of good repair and shall be calibrated by an accredited testing laboratory or engineering company within a period of two years from the date of the test being performed.

All ADA ramps shall be installed with detectable warning units. Reference the Special Provision entitled "Detectable Warning Tiles" for additional requirements.

d. Measurement and Payment.- The completed work as measured for the following pay items will be paid for at the contract unit prices for the following contract items (pay items):

| <u>Contract Item (Pay Item)</u> | <u>Pay Unit</u> |
|--|------------------------|
| Sidewalk Ramp, Conc, 6 inch, ADA, Modified | Square Foot |

The above items will be measured by area in square feet and be paid for at their respective contract unit price, which price shall be payment in full for all labor, equipment and material needed to accomplish this work. The unit price shall also include all costs associated with sawcutting curbs to provide openings for ADA sidewalk ramps as indicated on the plans.

CITY OF ANN ARBOR
DETAILED SPECIFICATION
FOR
CONCRETE SIDEWALK AND ADA RAMPS

FTCH/VDG:AA/MGN

3 of 3

02/01/16

Excavation and placement of Granular Material, Class II, bedding material shall be included in the item of work "Shared use Path, Grading" and shall be paid for separately, per square yard.

Detectable warning units cast in place, shall be paid for in accordance with the Detailed Specification for Detectable Warning Tiles.

CITY OF ANN ARBOR
SPECIAL PROVISION
FOR
DETECTABLE WARNING TILES

AA:MGN

1 of 3

11/20/15

a. Description.- This work shall consist of furnishing and installing cast in place detectable warning units in compliance to the Americans with Disability Act (ADA). All work shall be in accordance with the Special Provision for “Concrete Sidewalk, ADA Ramps, and Driveway Approaches,” Section 803 of the MDOT 2012 Standard Specifications for Construction, MDOT Standard Detail R-28-I (or most current version in effect at the time of bidding), as indicated on the plans, and as modified herein.

b. Related Documents.- Americans with Disabilities Act (ADA) Title 49 CFR Transportation, Part 37.9 Standards for Accessible Transportation Facilities, Appendix A, Section 4.29.2 Detectable Warnings on Walking Surfaces

American Society for Testing and Materials (ASTM) Test Methods B117, C1028, D543, D570, D638, D695, D790, D2486, D2565, D5420, and E84.

c. Submittals.- Submit manufacturer’s literature describing products, installation procedures and maintenance instructions. Provide cast-in-place detectable surface tiles and accessories as produced by a single manufacturer.

Samples for Verification Purposes: Submit two (2) tile samples minimum 6” x 8” of the kind proposed for use. Samples shall be properly labeled and shall contain the following information: Name of Project; Submitted by; Date of Submittal; Manufacture’s Name; Catalog No.; and Date of Fabrication.

Material Test Reports: Submit current test reports from a qualified, independent, testing laboratory indicating that materials proposed for use are in compliance with requirements and meet the properties indicated. The required tests listed elsewhere in this Special Provision shall be performed by a certified and qualified independent testing laboratory on a cast-in-place tactile warning system. All test reports submitted shall be certified by the testing laboratory and shall clearly state that all tests were completed within 5 years of the date of the submittal. The manufacturer shall certify in writing that the materials provided to the project are manufactured with the same materials and manufacturing procedures as those used in the materials on which the test were performed.

CITY OF ANN ARBOR
SPECIAL PROVISION
FOR
DETECTABLE WARNING TILES

AA:MGN

2 of 3

11/20/15

c. Materials.- The detectable warning tiles shall be colored as Federal Number 22144 (frequently referred to as “Colonial Red” or “Brick Red”). The detectable warning tiles shall meet the following material properties, dimensions, and tolerances using the most current test methods:

1. Water Absorption: Not to exceed 0.35% when tested in accordance with ASTM-D570
2. Slip Resistance: 0.80 minimum combined wet/ dry static coefficient of friction on top domes and field area, when tested in accordance with ASTM C1028.
3. Compressive Strength: 18,000 psi minimum, when tested in accordance with ASTM D695.
4. Tensile Strength: 10,000 psi minimum, when tested in accordance with ASTM D638.
5. Flexural Strength: 24,000 psi minimum, when tested in accordance with ASTM D790.
6. Chemical Stain Resistance: No reaction to 1% hydrochloric acid, urine, chewing gum, soap solution, motor oil, bleach, calcium chloride, when tested in accordance with ASTM D543 or D1308.
7. Wear Depth: 300 minimum, when tested in accordance with ASTM C501.
8. Flame Spread: 25 maximum, when tested in accordance with ASTM E84.
9. Gardner Impact: 50 in.-lbs. minimum, when tested in accordance with Geometry “GE” of ASTM D5420.
10. Accelerated Weathering of Tile when tested by ASTM-G155 or ASTM G151 shall exhibit the following result- $\Delta E < 6.0$ as well as no deterioration, fading or chalking of surface when exposed to 3000 hours minimum exposure.
11. Wheel Loading: The cast in place tile shall be mounted on a concrete platform with a 1/2” airspace at the underside of the tile top plate then subjected to the specified maximum load of 10,400 lbs., corresponding to an 8,000 lb individual wheel load and a 30% impact factor. The tile shall exhibit no visible damage at

CITY OF ANN ARBOR
SPECIAL PROVISION
FOR
DETECTABLE WARNING TILES

AA:MGN

3 of 3

11/20/15

the maximum load of 10,400 lbs using AASHTO-HB17 single sheet HS20-44 loading "Standard Specifications for Highways and Bridges."

12. Salt and Spray Performance of Tile and Adhesive System when tested to ASTM-B117 not to show any deterioration or other defects after 100 hours of exposure

d. Construction Methods.- Installer's Qualifications: Engage an experienced Installer who has successfully completed tile installations similar in material, design, and extent to that indicated for this Project.

The contractor shall follow manufacturer specifications for installation, except where they conflict with MDOT Standard Detail R-28-H (or most current edition in effect at the time of bidding), or other project requirements.

e. Measurement and Payment.- The completed work as measured for the following pay items will be paid for at the contract unit prices for the following contract items (pay items):

| <u>Contract Item (Pay Item)</u> | <u>Pay Unit</u> |
|--|------------------------|
| Detectable Warning Tiles | Square Foot |

The unit price for this item shall include all labor, material, and equipment costs required to complete the work.

CITY OF ANN ARBOR
DETAILED SPECIFICATION
FOR
SHARED USE PATH, GRADING

FTCH/VDG:COAA

1 of 1

03/17/16

a. Description.- This work shall consist of excavating, providing additional granular material, reshaping and compacting grade, and removing and disposing of excess material to place new sidewalk, sidewalk ramps, concrete paver with integral curb and small retaining wall section as indicated on the plan sheets and this Detailed Specification.

b. Materials.- Granular materials shall be provided as needed and in accordance with Section 902 of the 2012 MDOT Standard Specifications for Construction.

c. Construction Methods.- The Contractor is responsible to prepare and reshape the grade of the areas listed above in accordance with Section 806 of the 2012 MDOT Standard Specifications for Construction, to obtain the finish grades as indicated on the plan sheets.

d. Measurement and Payment.- The completed work as measured for the following pay items will be paid for at the contract unit prices for the following contract item (pay item):

| <u>Contract Item (Pay Item)</u> | <u>Pay Unit</u> |
|--|------------------------|
| Shared use Path, Grading | Square Yard |

The above item will be measured by area in square yard, and be paid for at the contract unit price, which price shall be payment in full for all labor, equipment and material needed to accomplish this work.

CITY OF ANN ARBOR
DETAILED SPECIFICATION
FOR
SIGN, REMOVE, SALVAGE, REINSTALL

FTCH/VDG:COAA

1 of 1

02/2016

a. Description.- This work shall consist of removing a perforated steel square tube sign breakaway system, as shown on drawings, in its entirety, at its foundation, salvaging, and reinstalling with new anchorage per MDOT Signing Standard Sign-207 as described in subsection 810.03.U of the MDOT Standard Specifications for Construction.

b. Materials.- Reuse existing sign post, sign panels and anchor plate. All post and anchor materials shall be in accordance with MDOT Traffic Signing Standard Sign-207.

c. Construction.-

1. The sign post with attached signs shall be taken down and stored in accordance with MDOT standards. Signs damaged during removal, storage, and placement shall be replaced with identical new signs at the Contractor's expense.
2. The sign post shall be re-installed at same location and facing in the same direction as existing.
3. The post shall be re-installed plumb with the sign face installed level.

d. Measurement and Payment.- The completed work shall be paid for at the contract unit price for the following Contract items:

Sign, Rem, Salv, Reinstall.....Ea

Payment for the above item of work shall include all labor, materials, and equipment needed to complete the work as shown on the plans, as detailed in the specifications, and as directed by the Supervising Professional.

CITY OF ANN ARBOR
DETAILED SPECIFICATION
FOR
MAINTAINING TRAFFIC

CON:FTCH

1 of 5

02/2016

- a. Description.-** This work shall consist of sidewalk and planter wall rehabilitation of the corner island at the Broadway and Division Street intersection in the City of Ann Arbor, Washtenaw County.
- b. General.-** Traffic shall be maintained according to Sections 104.07, 104.11, and 812 of the 2012 Standard Specifications for Construction, the maintenance of traffic details and as specified here.
- 1. The Contractor shall notify the Supervising Professional a minimum of seven (7) calendar days prior to the implementation of any lane closures and/or major traffic shifts. The Contractor shall start work at the time agreed upon with the Supervising Professional. Any delay in the start time may result in a delay to the project, until another start date can be agreed upon with the Supervising Professional. Any delay with regard to a revised start date may not be reason for an extension of contract time.**
 - 2. The Contractor shall coordinate their operations with Contractors performing work on other projects within or adjacent to the Construction Influence Area (CIA) as described below.**
- c. Construction Influence Area (CIA).-** The CIA shall include the rights-of-way of the following roads with the approximate limits described below:
- 1. On North Division Street from approximately 0.1 miles south of Kingsley Street to approximately 0.1 miles north of Broadway Street.**
 - 2. On Broadway from approximately 0.1 miles west of N. Division Street/East Summit Street to approximately 0.1 miles east of Swift Street.**
 - 3. In addition, the CIA shall include the right-of-way of any intersecting roads adjacent to the work zone for a distance of approximately 1/4 mile in advance of the trunkline. The roads include, but are not limited to:**

Kingsley Street, Detroit Street, Carey Street, Beakes Street, and East Summit Street.
- d. Traffic Restrictions.-**
- 1. No work shall be performed, or lane closures allowed, during the Memorial Day, Independence Day, Labor Day, or Thanksgiving holiday periods, as defined by the Supervising Professional.**

2. On North Division Street and Broadway, and as directed by the Supervising Professional, the Contractor shall remove lane closures, road closures and detours and cease work prior to the following events:
 - A. University of Michigan graduation/commencement weekend and University of Michigan student move-in week/weekend. The Contractor shall be responsible to verify dates of these events.
 - B. University of Michigan home football Saturdays.
3. The project shall be open to traffic as defined in Section 107.21 of the 2012 MDOT Standard Specifications for Construction, by July 30, 2016. Project completion shall be by July 30, 2016. The contract shall be considered complete when the project is ready for use and all restoration and pavement marking activities have been completed.
4. A minimum of one lane of traffic in the specified direction shall be maintained at all times on North Division Street and Broadway. A minimum of one lane of traffic shall be maintained at all times at all intersecting roads, and as directed by the Supervising Professional. A single lane closure will be allowed on North Division Street and Broadway between the hours of 9:00 a.m. and 3:30 p.m., Monday through Friday.
5. Traffic shall be maintained at all times in accordance with the plans or as directed by the Supervising Professional. Use of temporary traffic regulators and traffic shifts will be allowed to move equipment and stage vehicles during specific times as directed by the Supervising Professional. The arrow panel, signs and channelizing tapers for the traffic regulator operations shall be placed at locations approved by the Supervising Professional for adequate visibility by oncoming traffic.
6. Cover existing regulatory, warning and construction signs that are not applicable during construction.
7. Maintain access for emergency vehicles at all times. The Contractor will be required to assist emergency vehicles (fire, ambulance, police) in gaining access into, around, and through the work zone at all times without exception. **The Contractor will be responsible for notifying the City a minimum of seven (7) calendar days prior to any lane closures, detours or major traffic shifts.**
8. The Contractor must complete and submit the "Lane Closure Notification/Request Form" to the Supervising Professional for approval prior to the actual closure date. If the lane closure request is per the maintenance of traffic in the contract documents, then the request must be submitted seven (7) calendar days in advance of the lane closure for approval. **If the lane closure request is not per the maintenance of traffic in the contract documents, then the request must be submitted ten (10) calendar days in advance of the lane closure for approval.** This includes all shifts/lane closures as stated per the contract documents or any new lane closure requests submitted by the Contractor. The Supervising Professional will have seven (7) calendar days to review the lane closure request for acceptance or provide comments for revisions required to obtain acceptance. **The Contractor must not implement a lane closure prior to approval by the Supervising Professional.** In addition, the Contractor must notify the Supervising Professional when the lane closure is removed. See Lane Closure Notification/Request Form contained in the Proposal.

9. Once work is initiated that includes any lane restrictions, that work shall be continuous until completed. A lack of work activity for more than one week will require the removal and replacement of lane restrictions at the Contractor's expense.
 10. Changes or adjustments in the staging plans, temporary pavement markings, signs and maintaining traffic typical provided may be necessary to field fit conditions as determined by the Supervising Professional.
- e. Stage Construction.-** The traffic control required by this Special Provision for work on North Division Street, Broadway, and adjacent roadways is based on the suggested sequence of operations described below. The Contractor may request an alternate traffic control plan, however it must be approved in writing by the Supervising Professional prior to its implementation. The following is a brief description of traffic control required during each construction stage:
1. North Division Street and Broadway:
 - A. Provide a single lane closure and traffic shift on northbound Division Street and provide a single lane closure on westbound Broadway Street. Provide a detour for the corner island sidewalk. Place traffic control devices per plans and Michigan Manual of Uniform Traffic Control Devices (MMUTCD).
 - B. Install soil erosion and sediment control (SESC) measures.
 - C. Perform sidewalk and planter rehabilitation.
 - D. Remove temporary traffic control devices and open road to full traffic operations.
- f. Traffic Control Devices.-**
1. General
 - A. Conform all traffic control devices and their usage to Part 6 of the 2011 MMUTCD. This document can be found at the following website:
<http://mdotwas1.mdot.state.mi.us/public/tands/plans.cfm>
 - B. Place advance signs (W20-1 - "Road Work Ahead") and plastic drums/42" channeling devices at any work site with uncompleted work during non-working periods as the Supervising Professional directs. All costs associated with this work will be borne by the Contractor.
 - C. Temporary Traffic Control Devices must conform to Traffic and Safety Standard Plans WZD-100-A and WZD-125-E.
 2. Temporary Signs
 - A. Distances shown between construction warning, regulatory, and guide signs shown on the typical sign sequences are approximate and may require field adjustments as directed by the Supervising Professional. Refer to the attached sheet M0020a for Tables of "D" and "L" values.
 - B. Ground driven sign supports for temporary signs shall be as shown on attached Typical Plan WZD-100-A. Refer to Traffic and Safety Special Detail WZD-125-E for portable supports.

- C. Place signing for single lane closures on Broadway as shown on attached Typical M0270a.
- D. Place signing for single lane closures on North Division Street as shown on attached Typical M0730a.
- E. W20-15b (“WATCH FOR TRAFFIC BACKUP/BE PREPARED TO STOP”) signs are included in the quantities to be placed on North Division Street and Broadway. **Recommended sign placement is a minimum of 1,000 feet in advance of the first Road Work Ahead (W20-1) sign.** The location of the W20-15b signs may need to be field adjusted if the traffic backups are longer than anticipated during the lane closures as directed by the Supervising Professional. The W20-15b sign placement recommendations are based on the signing sequence used with Typical M0240a.
- F. Mount all temporary signs at a five-foot minimum bottom height in uncurbed areas and seven-foot minimum bottom height in curbed or pedestrian areas.
- G. Consider distances shown between construction warning, regulatory and guide signs shown on the typicals as approximate. Signs may require field adjustment, as the Supervising Professional directs.
- H. All temporary signs must be Type B, Prismatic.
- I. Fabricate all temporary signs with legends and symbols flush to the signs face and not extending beyond the sign borders or edges.
- J. Refer to Traffic and Safety Special Detail WZD-125-E when installing temporary diamond signs with portable supports. Note that the Type A Warning Light is required.
- K. When a portable construction sign is no longer applicable, remove it or lay it down on its non-reflective side with its feet off.
- L. All signs, temporary or permanent, that are damaged as a result of Contractor’s operations shall be replaced by the Contractor at the Contractor’s expense.
- M. Use Type C Lighted Arrows (minimum 48-inch x 96-inch) to merge traffic and secure by elevating the tires above the ground, or use wheel chocks or sandbags.
- N. The Federal Highway Administration (FHWA) requires all signs to be National Cooperative Highway Research Program (NCHRP) 350 crashworthy. For design and configuration refer to their website:
http://safety.fhwa.dot.gov/roadway_dept/road_hardware/workzone_pdmnu.cfm

3. Channelizing Devices.

- A. Use plastic drums with high intensity sheeting as channelizing devices on North Division Street, Broadway, and impacted local roads. Devices are to be kept in **acceptable** conditions, as defined by the American Traffic Safety Service Association (ATSSA).
- B. When a lane is closed, channelizing devices at cross streets and major drives shall be used to clearly define the closed lane to the entering vehicles.
- C. All Barricades, Type III used on this project shall have high intensity sheeting on both sides.

- D. Placement of Type III barricades shall be as shown in the staging plans and as directed by the Supervising Professional. Stripes on barricade rails shall be oriented as prescribed in the most current version of the MMUTCD.
4. Temporary Pavement Markings
- A. Temporary pavement markings shall consist of:
 - Pavt Mrkg, Wet Reflective Type R, Tape, White, Temp
 - Pavt Mrkg, Wet Reflective Type R, Tape, Yellow, Temp
 - B. Temporary pavement markings, Type R shall be placed on existing pavement areas that will remain after construction and on new pavement for interim traffic control at locations specified by the Supervising Professional.
 - D. Temporary lane use control arrows shall be fabricated with White Wet Reflective Type R Temporary Pavement Marking Tape as directed by the Supervising Professional in conformance with MDOT pavement marking guides for size and location.
 - E. When Type R tape is used, it shall be the Contractor's responsibility to ensure that all temporary pavement markings adhere to the pavement surface until permanent markings are installed. Any additional adhesives or other materials used shall be included with these pay items.
 - F. Removal of pavement markings on surfaces that will not be milled or overlaid must be done by non-destructive, abrasive methods as approved by the Supervising Professional. The pavement marking removal must not scar the pavement that will be replaced.
5. Traffic Signals
- A. Any signal indications or overhead signing in conflict with traffic movements during a stage shall be bagged during that stage. This work shall only be performed by the City of Ann Arbor.
- g. Measurement and Payment.-** The estimate of quantities for maintaining traffic is based on signing and related traffic control devices per the construction plans.
- 1. Payment for temporary signs shall be made on the maximum square foot of dissimilar sign legends in use at any one time during the project.
 - 2. Payment for temporary and permanent pavement markings shall be made by the foot.
 - 3. Any additional signing or maintaining traffic devices required to expedite the construction shall be at the Contractor's expense.

MINIMUM MERGING TAPER LENGTH "L" (FEET)

| OFFSET FEET | POSTED SPEED LIMIT, MPH (PRIOR TO WORK AREA) | | | | | | | | | |
|----------------|--|-----|-----|-----|-----|-----|-----|-----|-----|------|
| | 25 | 30 | 35 | 40 | 45 | 50 | 55 | 60 | 65 | 70 |
| 1 | 10 | 15 | 20 | 27 | 45 | 50 | 55 | 60 | 65 | 70 |
| 2 | 21 | 30 | 41 | 53 | 90 | 100 | 110 | 120 | 130 | 140 |
| 3 | 31 | 45 | 61 | 80 | 135 | 150 | 165 | 180 | 195 | 210 |
| 4 | 42 | 60 | 82 | 107 | 180 | 200 | 220 | 240 | 260 | 280 |
| 5 | 52 | 75 | 102 | 133 | 225 | 250 | 275 | 300 | 325 | 350 |
| 6 | 63 | 90 | 123 | 160 | 270 | 300 | 330 | 360 | 390 | 420 |
| 7 | 73 | 105 | 143 | 187 | 315 | 350 | 385 | 420 | 455 | 490 |
| 8 | 83 | 120 | 163 | 213 | 360 | 400 | 440 | 480 | 520 | 560 |
| 9 | 94 | 135 | 184 | 240 | 405 | 450 | 495 | 540 | 585 | 630 |
| 10 | 104 | 150 | 204 | 267 | 450 | 500 | 550 | 600 | 650 | 700 |
| 11 | 115 | 165 | 225 | 293 | 495 | 550 | 605 | 660 | 715 | 770 |
| 12 | 125 | 180 | 245 | 320 | 540 | 600 | 660 | 720 | 780 | 840 |
| 13 | 135 | 195 | 266 | 347 | 585 | 650 | 715 | 780 | 845 | 910 |
| 14 | 146 | 210 | 286 | 374 | 630 | 700 | 770 | 840 | 910 | 980 |
| 15 | 157 | 225 | 307 | 400 | 675 | 750 | 825 | 900 | 975 | 1050 |

TAPER LENGTH "L" IN FEET

THE FORMULAS FOR THE MINIMUM LENGTH OF A MERGING TAPER IN DERIVING THE "L" VALUES SHOWN IN THE ABOVE TABLES ARE AS FOLLOWS:

"L" = $\frac{W \times S^2}{60}$ WHERE POSTED SPEED PRIOR TO THE WORK AREA IS 40 MPH OR LESS

"L" = S x W WHERE POSTED SPEED PRIOR TO THE WORK AREA IS 45 MPH OR GREATER

- L = MINIMUM LENGTH OF MERGING TAPER
- S = POSTED SPEED LIMIT IN MPH PRIOR TO WORK AREA
- W = WIDTH OF OFFSET

TYPES OF TAPERS

UPSTREAM TAPERS

- MERGING TAPER
- SHIFTING TAPER
- SHOULDER TAPER
- TWO-WAY TRAFFIC TAPER

DOWNSTREAM TAPERS

(USE IS OPTIONAL)

TAPER LENGTH

- L - MINIMUM
- 1/2 L - MINIMUM
- 1/3 L - MINIMUM
- 100' - MAXIMUM
- 100' - MINIMUM (PER LANE)

| | | | |
|---|---|-------------------------|--------|
|  TRAFFIC AND SAFETY MAINTAINING TRAFFIC TYPICAL | TABLES FOR "L", "D" AND "B" VALUES | | |
| | DRAWN BY: CON:AE:djf CHECKED BY: BMM | JUNE 2006 PLAN DATE: | M0020a |
| FILE: K:/DGN/TSR/STDS/ENGLISH/MNTTRF/M0020a.dgn REV. 08/21/2006 | | | |

DISTANCE BETWEEN TRAFFIC CONTROL DEVICES "D"
AND LENGTH OF LONGITUDINAL BUFFER SPACE ON
"WHERE WORKERS PRESENT" SEQUENCES

| "D" DISTANCES | POSTED SPEED LIMIT, MPH (PRIOR TO WORK AREA) | | | | | | | | | |
|------------------|--|-----|-----|-----|-----|-----|-----|-----|-----|-----|
| | 25 | 30 | 35 | 40 | 45 | 50 | 55 | 60 | 65 | 70 |
| D (FEET) | 250 | 300 | 350 | 400 | 450 | 500 | 550 | 600 | 650 | 700 |

GUIDELINES FOR LENGTH OF
LONGITUDINAL BUFFER SPACE "B"

| SPEED* MPH | LENGTH FEET |
|---------------|----------------|
| 20 | 33 |
| 25 | 50 |
| 30 | 83 |
| 35 | 132 |
| 40 | 181 |
| 45 | 230 |
| 50 | 279 |
| 55 | 329 |
| 60 | 411 |
| 65 | 476 |
| 70 | 542 |

* POSTED SPEED, OFF PEAK 85TH PERCENTILE SPEED PRIOR TO WORK STARTING, OR THE ANTICIPATED OPERATING SPEED

1 BASED UPON AMERICAN ASSOCIATION OF STATE HIGHWAY AND TRANSPORTATION OFFICIALS (AASHTO) BRAKING DISTANCE PORTION OF STOPPING SIGHT DISTANCE FOR WET AND LEVEL PAVEMENTS (A POLICY ON GEOMETRIC DESIGN OF HIGHWAY AND STREETS), AASHTO. THIS AASHTO DOCUMENT ALSO RECOMMENDS ADJUSTMENTS FOR THE EFFECT OF GRADE ON STOPPING AND VARIATION FOR TRUCKS.

| | | | |
|--|---|-------------------------|--------|
|  Michigan Department of Transportation TRAFFIC AND SAFETY MAINTAINING TRAFFIC TYPICAL | TABLES FOR "L", "D" AND "B" VALUES | | |
| | DRAWN BY: CON:AE:djf CHECKED BY: BMM | JUNE 2006 PLAN DATE: | M0020a |
| FILE: K:/DGN/TSR/STDS/ENGLISH/MNTTRF/M0020a.dgn REV. 08/21/2006 | | | |

KEY

- • • CHANNELIZING DEVICES
- ← LIGHTED ARROW PANEL
- TRAFFIC FLOW
- REFLECTS EXISTING SPEED LIMIT

SIGN = 168 ft² - TYPE B PLUS ADDITIONAL R2-1s THROUGHOUT WORK AREA.

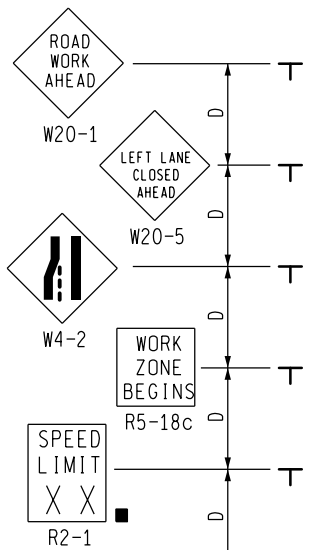

END ROAD WORK
PLACE THIS SIGN ALONG WITH THE ADVANCE WORK ZONE SIGNING AS DEPICTED ON THE APPROPRIATE TYPICAL M0030a-M0080a.

SPEED LIMIT XX R2-1
PLACE THROUGHOUT WORK AREA AS INDICATED AND AFTER ALL MAJOR CROSSROADS IF PERMANENT SIGNS ARE NOT IN PLACE.

SPEED LIMIT XX R2-1
PLACE THROUGHOUT WORK AREA AS INDICATED AND AFTER ALL MAJOR CROSSROADS IF PERMANENT SIGNS ARE NOT IN PLACE.

END ROAD WORK
PLACE THIS SIGN ALONG WITH THE ADVANCE WORK ZONE SIGNING AS DEPICTED ON THE APPROPRIATE TYPICAL M0030a-M0080a.

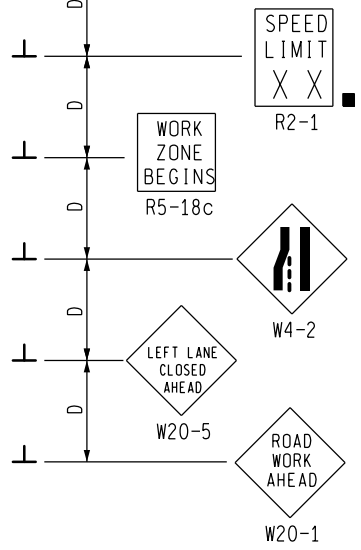
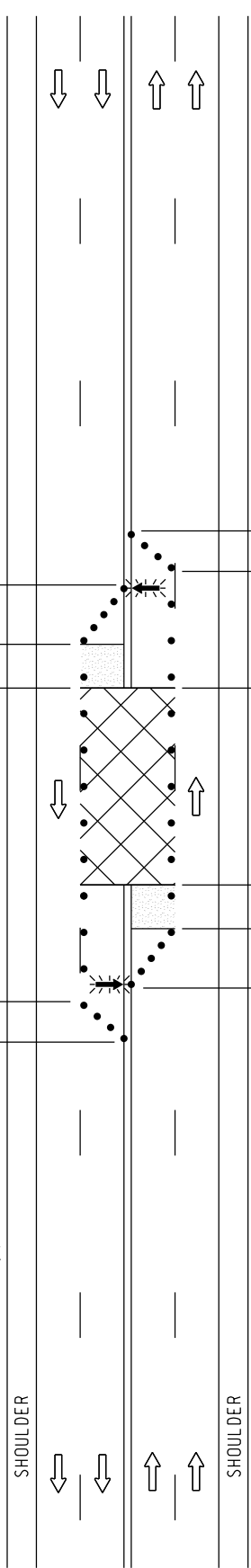

MDOT
Michigan Department of Transportation
TRAFFIC AND SAFETY
MAINTAINING TRAFFIC
TYPICAL

TYPICAL TEMPORARY TRAFFIC CONTROL FOR CLOSING THE CENTER TWO LANES OF A MULTI-LANE UNDIVIDED ROADWAY, (NO CLFLTO) NO SPEED REDUCTION

DRAWN BY: CON:AE:djf
CHECKED BY: BMM:CRB

OCTOBER 2011
PLAN DATE:

M0270a

SHEET 1 OF 2

NOT TO SCALE

FILE: PW RD/TS/Typicals/Signs/MT NON FWY/M0270a.dgn REV. 10/12/2011

NOTES

- 1B. D = DISTANCE BETWEEN TRAFFIC CONTROL DEVICES
L = MINIMUM LENGTH OF TAPER
B = LENGTH OF LONGITUDINAL BUFFER
SEE **M0020a** FOR "D," "L," AND "B" VALUES
2. ALL NON-APPLICABLE SIGNING WITHIN THE CIA SHALL BE MODIFIED TO FIT CONDITIONS, COVERED OR REMOVED.
3. DISTANCES BETWEEN SIGNS, THE VALUES FOR WHICH ARE SHOWN IN TABLE D, ARE APPROXIMATE AND MAY NEED ADJUSTING AS DIRECTED BY THE ENGINEER.
- 3A. THE "WORK ZONE BEGINS" (R5-18c) SIGN SHALL BE USED ONLY IN THE INITIAL SIGNING SEQUENCE IN THE WORK ZONE. SUBSEQUENT SEQUENCES IN THE SAME WORK ZONE SHALL OMIT THIS SIGN AND THE QUANTITIES SHALL BE ADJUSTED APPROPRIATELY.
- 4B. THE MAXIMUM RECOMMENDED DISTANCE(S) BETWEEN CHANNELIZING DEVICES SHOULD BE EQUAL IN FEET TO THE POSTED SPEED IN MILES PER HOUR ON MERGING TAPER(S), TWICE THE POSTED SPEED IN THE PARALLEL AREA(S), AND 25 FEET IN THE DOWNSTREAM TAPER AREA(S).
5. FOR OVERNIGHT CLOSURES, TYPE III BARRICADES SHALL BE LIGHTED.
6. WHEN CALLED FOR IN THE FHWA ACCEPTANCE LETTER FOR THE SIGN SYSTEM SELECTED, THE TYPE A WARNING FLASHER, SHOWN ON THE WARNING SIGNS, SHALL BE POSITIONED ON THE SIDE OF THE SIGN NEAREST THE ROADWAY.
7. ALL TEMPORARY SIGNS, TYPE III BARRICADES, THEIR SUPPORT SYSTEMS AND LIGHTING REQUIREMENTS SHALL MEET NCHRP 350 CRASHWORTHY REQUIREMENTS STIPULATED IN THE CURRENT EDITION OF THE MICHIGAN MANUAL ON UNIFORM TRAFFIC CONTROL DEVICES, THE CURRENT EDITION OF THE STANDARD SPECIFICATIONS FOR CONSTRUCTION, THE STANDARD PLANS AND APPLICABLE SPECIAL PROVISIONS. ONLY DESIGNS AND MATERIALS APPROVED BY MDOT WILL BE ALLOWED.
8. WHEN BUFFER AREAS ARE ESTABLISHED, THERE SHALL BE NO EQUIPMENT OR MATERIALS STORED OR WORK CONDUCTED IN THE BUFFER AREA.
21. ALL EXISTING PAVEMENT MARKINGS WHICH ARE IN CONFLICT WITH EITHER PROPOSED CHANGES IN TRAFFIC PATTERNS OR PROPOSED TEMPORARY TRAFFIC MARKINGS, SHALL BE REMOVED BEFORE ANY CHANGE IS MADE IN THE TRAFFIC PATTERN. EXCEPTION WILL BE MADE FOR DAYTIME-ONLY TRAFFIC PATTERNS THAT ARE ADEQUATELY DELINEATED BY OTHER TRAFFIC CONTROL DEVICES.
- 26C. THE LIGHTED ARROW PANEL SHALL BE LOCATED AT THE BEGINNING OF THE MERGING TAPER AS SHOWN. WHEN PHYSICAL LIMITATIONS RESTRICT ITS PLACEMENT AS INDICATED, THEN IT SHALL BE PLACED AS CLOSE TO THE BEGINNING OF THE MERGING TAPER AS POSSIBLE.

SIGN SIZES

DIAMOND WARNING - 48 " x 48 "
 R2-1 REGULATORY - 48 " x 60 "
 R5-18c REGULATORY - 48 " x 48 "

NOT TO SCALE

| | | |
|--|---|----------------------------|
|  TRAFFIC AND SAFETY MAINTAINING TRAFFIC TYPICAL | TYPICAL TEMPORARY TRAFFIC CONTROL FOR CLOSING THE CENTER TWO LANES OF A MULTI-LANE UNDIVIDED ROADWAY, (NO CLFLT0) NO SPEED REDUCTION | |
| | DRAWN BY: CON:AE:djf CHECKED BY: BMM:CRB | OCTOBER 2011 PLAN DATE: |
| FILE: PW RD/TS/Typicals/Signs/MT NON FWY/M0270a.dgn REV. 10/12/2011 | | |

END ROAD WORK

PLACE THIS SIGN ALONG WITH THE ADVANCE WORK ZONE SIGNING AS DEPICTED ON THE APPROPRIATE TYPICAL M0030a-M0080a.

END ROAD WORK

PLACE THIS SIGN ALONG WITH THE ADVANCE WORK ZONE SIGNING AS DEPICTED ON THE APPROPRIATE TYPICAL M0030a-M0080a.

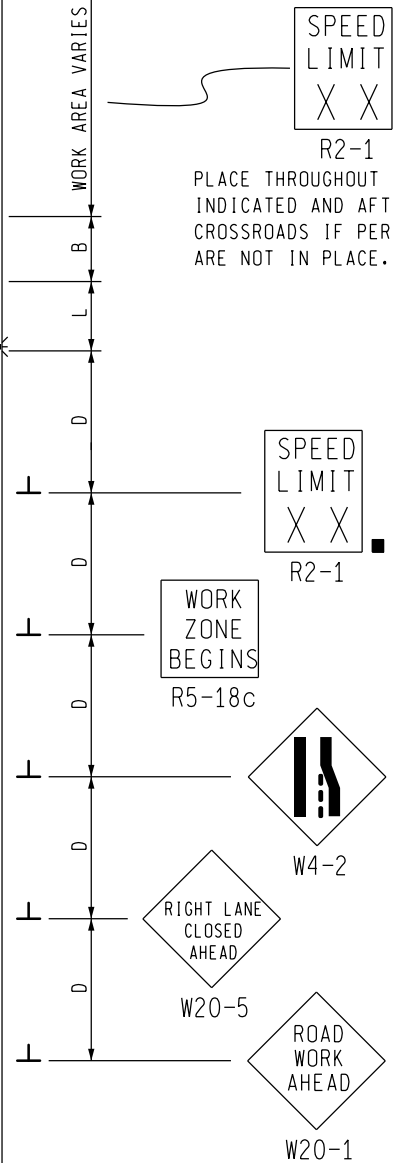
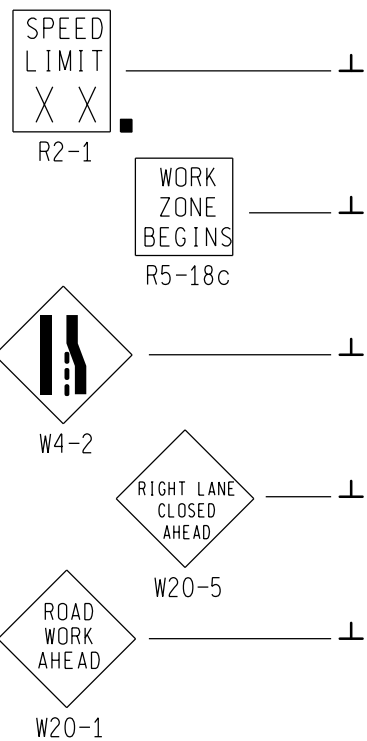

SPEED LIMIT XX
R2-1

PLACE THROUGHOUT WORK AREA AS INDICATED AND AFTER ALL MAJOR CROSSROADS IF PERMANENT SIGNS ARE NOT IN PLACE.

SHOULDER

SHOULDER

KEY

- • • CHANNELIZING DEVICES
- ← LIGHTED ARROW PANEL
- TRAFFIC FLOW
- REFLECTS EXISTING SPEED LIMIT

SIGN = 168 ft± - TYPE B PLUS ADDITIONAL R2-1's THROUGHOUT WORK AREA

NOT TO SCALE

| | | | |
|---|--|--|--------------------------------|
| | | <p>TYPICAL TEMPORARY TRAFFIC CONTROL FOR A ONE-LANE CLOSURE ON A DIVIDED ROADWAY, NO SPEED REDUCTION</p> | |
| <p>TRAFFIC AND SAFETY MAINTAINING TRAFFIC TYPICAL</p> | | <p>OCTOBER 2011 PLAN DATE:</p> | <p>M0730a SHEET 1 OF 2</p> |
| <p>DRAWN BY: CON:AE:djf CHECKED BY: BMM:CRB</p> | <p>FILE: PW RD/TS/Typicals/Signs/MT NON FWY/M0730a.dgn</p> | <p>REV. 10/26/2011</p> | |

NOTES

- 1B. D = DISTANCE BETWEEN TRAFFIC CONTROL DEVICES
L = MINIMUM LENGTH OF TAPER
B = LENGTH OF LONGITUDINAL BUFFER
SEE M0020a FOR "D," "L," AND "B" VALUES
2. ALL NON-APPLICABLE SIGNING WITHIN THE CIA SHALL BE MODIFIED TO FIT CONDITIONS, COVERED OR REMOVED.
3. DISTANCES BETWEEN SIGNS, THE VALUES FOR WHICH ARE SHOWN IN TABLE D, ARE APPROXIMATE AND MAY NEED ADJUSTING AS DIRECTED BY THE ENGINEER.
- 3A. THE "WORK ZONE BEGINS" (R5-18c) SIGN SHALL BE USED ONLY IN THE INITIAL SIGNING SEQUENCE IN THE WORK ZONE. SUBSEQUENT SEQUENCES IN THE SAME WORK ZONE SHALL OMIT THIS SIGN AND THE QUANTITIES SHALL BE ADJUSTED APPROPRIATELY.
- 4E. THE MAXIMUM RECOMMENDED DISTANCE(S) BETWEEN CHANNELIZING DEVICES SHOULD BE EQUAL IN FEET TO THE POSTED SPEED IN MILES PER HOUR ON TAPER(S) AND TWICE THE POSTED SPEED IN THE PARALLEL AREA(S).
5. FOR OVERNIGHT CLOSURES, TYPE III BARRICADES SHALL BE LIGHTED.
6. WHEN CALLED FOR IN THE FHWA ACCEPTANCE LETTER FOR THE SIGN SYSTEM SELECTED, THE TYPE A WARNING FLASHER, SHOWN ON THE WARNING SIGNS, SHALL BE POSITIONED ON THE SIDE OF THE SIGN NEAREST THE ROADWAY.
7. ALL TEMPORARY SIGNS, TYPE III BARRICADES, THEIR SUPPORT SYSTEMS AND LIGHTING REQUIREMENTS SHALL MEET NCHRP 350 CRASHWORTHY REQUIREMENTS STIPULATED IN THE CURRENT EDITION OF THE MICHIGAN MANUAL ON UNIFORM TRAFFIC CONTROL DEVICES, THE CURRENT EDITION OF THE STANDARD SPECIFICATIONS FOR CONSTRUCTION, THE STANDARD PLANS AND APPLICABLE SPECIAL PROVISIONS. ONLY DESIGNS AND MATERIALS APPROVED BY MDOT WILL BE ALLOWED.
8. WHEN BUFFER AREAS ARE ESTABLISHED, THERE SHALL BE NO EQUIPMENT OR MATERIALS STORED OR WORK CONDUCTED IN THE BUFFER AREA.
21. ALL EXISTING PAVEMENT MARKINGS WHICH ARE IN CONFLICT WITH EITHER PROPOSED CHANGES IN TRAFFIC PATTERNS OR PROPOSED TEMPORARY TRAFFIC MARKINGS, SHALL BE REMOVED BEFORE ANY CHANGE IS MADE IN THE TRAFFIC PATTERN. EXCEPTION WILL BE MADE FOR DAYTIME-ONLY TRAFFIC PATTERNS THAT ARE ADEQUATELY DELINEATED BY OTHER TRAFFIC CONTROL DEVICES.
26. THE LIGHTED ARROW PANEL SHALL BE LOCATED AT THE BEGINNING OF THE TAPER AS SHOWN. WHEN PHYSICAL LIMITATIONS RESTRICT ITS PLACEMENT AS INDICATED, THEN IT SHALL BE PLACED AS CLOSE TO THE BEGINNING OF THE TAPER AS POSSIBLE.

SIGN SIZES

DIAMOND WARNING - 48" x 48"
R2-1 REGULATORY - 48" x 60"
R5-18c REGULATORY - 48" x 48"

NOT TO SCALE

| | | | |
|--|--------------|--|--------|
|  TRAFFIC AND SAFETY MAINTAINING TRAFFIC TYPICAL | | TYPICAL TEMPORARY TRAFFIC CONTROL FOR A ONE-LANE CLOSURE ON A DIVIDED ROADWAY, NO SPEED REDUCTION | |
| DRAWN BY: CON:AE:djf | OCTOBER 2011 | M0730a | SHEET |
| CHECKED BY: BMM:CRB | PLAN DATE: | | 2 OF 2 |
| FILE: PW RD/TS/Typicals/Signs/MT NON FWY/M0730a.dgn REV. 10/26/2011 | | | |

SIGN MATERIAL SELECTION TABLE

| SIGN SIZE | SIGN MATERIAL TYPE | | |
|--------------------------|--------------------|---------|----------|
| | TYPE I | TYPE II | TYPE III |
| ≤ 36" X 36" | | X | X |
| >36" X 36" ≤ 96" TO WIDE | | X | |
| > 96" WIDE TO 144" WIDE | X | X | |
| > 144" WIDE | X | | |

TYPE I ALUMINUM EXTRUSION
 TYPE II PLYWOOD
 TYPE III ALUMINUM SHEET

ROUNDING OF CORNERS IS NOT REQUIRED FOR TYPE I OR II SIGNS.
 VERTICAL JOINTS ARE NOT PERMITTED.
 HORIZONTAL JOINTS THROUGH SIGN LEGEND OR SYMBOLS ARE NOT PERMITTED.

POST SIZE REQUIREMENTS TABLE

| SIGN AREA (ft ²) | POST TYPE | | |
|---------------------------------|-----------------|----------------------|--------------|
| | U-CHANNEL STEEL | SQUARE TUBULAR STEEL | WOOD |
| ≤9 | 1 - 3 lb/ft* | 1 - 2" 12 or 14 GA* | N/A |
| 9 ≤ 20 | 2 - 3 lb/ft | 2 - 2" 12 or 14 GA | 1 - 4" X 6"* |
| > 20 ≤ 30 | N/A | N/A | 2 - 4" X 6" |
| > 30 ≤ 60 | N/A | N/A | 2 - 6" X 8" |
| > 60 ≤ 84 | N/A | N/A | 3 - 6" X 8" |

*SIGNS 4 FEET AND GREATER IN WIDTH REQUIRE 2 POSTS.
 SIGNS GREATER THAN 8 FEET IN WIDTH REQUIRE 2 OR 3 WOOD
 POSTS DEPENDING ON AREA OF SIGN.
 A MAXIMUM OF 2 POSTS WITHIN A 7' PATH IS PERMITTED.

NOT TO SCALE

File:PW/Doc/RD/T&S/Typ/Dev/Sign MainTraf D/WZD-100-A Rev. 8/21/06 ECH

| | | | | |
|---|---|--|------------------|--|
|  Michigan Department of Transportation PREPARED BY TRAFFIC AND SAFETY SUPPORT AREA DRAWN BY: CON/ECH CHECKED BY: AUG | _____ ENGINEER OF DELIVERY _____ ENGINEER OF DEVELOPMENT PENDING _____ FHWA APPROVAL DATE | MICHIGAN DEPARTMENT OF TRANSPORTATION BUREAU OF HIGHWAYS DELIVERY STANDARD PLAN FOR GROUND DRIVEN SIGN SUPPORTS FOR TEMP SIGNS | | |
| | 8/2006 | WZD-100-A | SHEET 1 of 11 | |
| | PLAN DATE | | | |

NOTE: THE ORIGINAL SIGNED COPY IS KEPT ON FILE AT THE MICHIGAN DEPARTMENT OF TRANSPORTATION.

2 POST SIGN SUPPORT SPACING

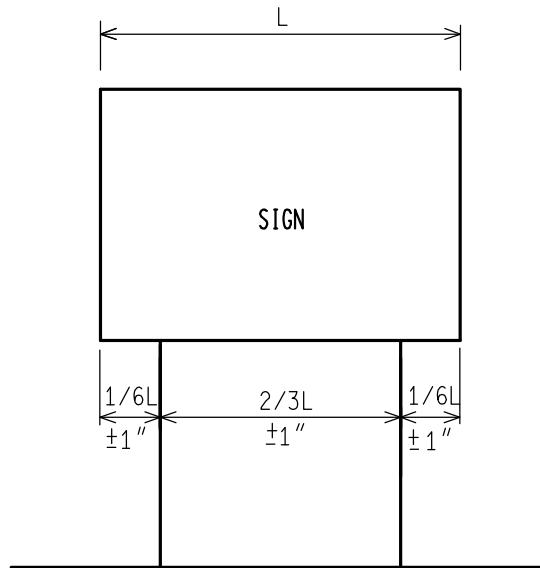

3 POST SIGN SUPPORT SPACING

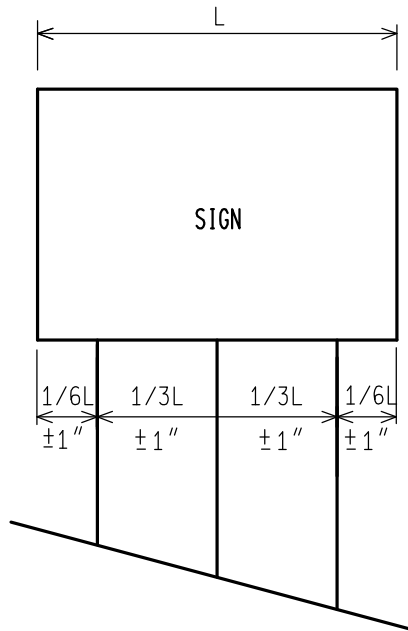

* FOR ALL 11' AND 12' LONG SIGNS ON 3 WOOD SUPPORTS, SPREAD POSTS SO AS TO HAVE A 8' MIN. TO 9' MAX. DISTANCE BETWEEN OUTSIDE POSTS.

NOT TO SCALE

| | | | | |
|--|-------------------------------|---------------------|---------------------------------------|------------------|
| MICHIGAN DEPARTMENT OF TRANSPORTATION BUREAU OF HIGHWAYS DELIVERY STANDARD PLAN | PENDING FHWA APPROVAL DATE | 8/2006 PLAN DATE | <h3 style="margin: 0;">WZD-100-A</h3> | SHEET 2 of 11 |
| File:PW/Doc/RD/T&S/Typ/Dev/Sign MainTraf D/WZD-100-A Rev. 8/21/06 ECH | | | | |

NOTE: THE ORIGINAL SIGNED COPY IS KEPT ON FILE AT THE MICHIGAN DEPARTMENT OF TRANSPORTATION.

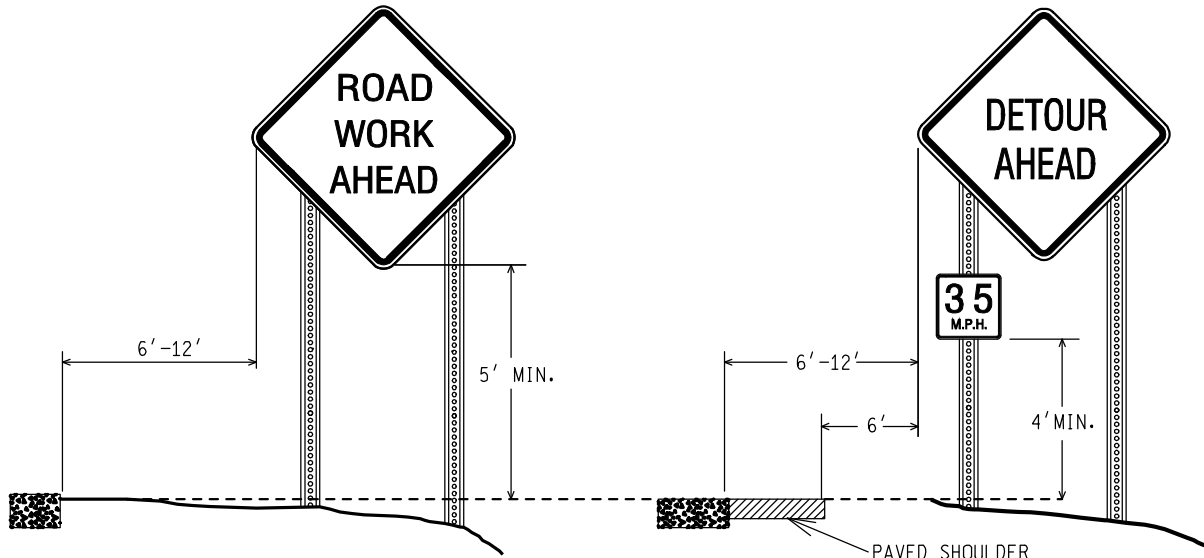

RURAL

RURAL WITH ADVISORY SPEED PLATE

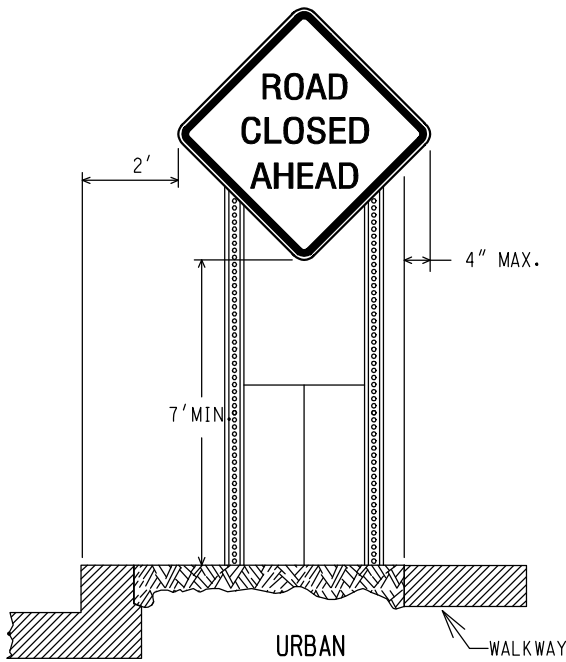

URBAN

WALKWAY

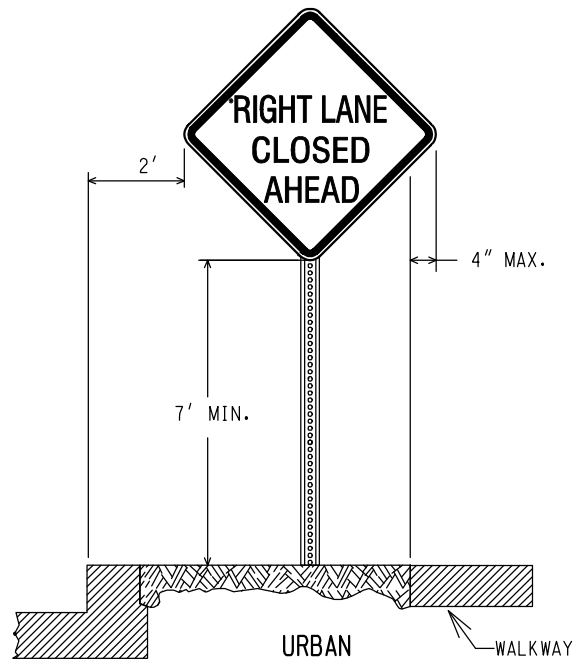

URBAN

WALKWAY

(CURBED AREAS OR WHERE WALKWAYS ARE PRESENT)

(CURBED AREAS OR WHERE WALKWAYS ARE PRESENT)

BOTTOM HEIGHT AND OFFSET

NOT TO SCALE

MICHIGAN DEPARTMENT OF TRANSPORTATION
BUREAU OF HIGHWAYS DELIVERY STANDARD PLAN

PENDING
FHWA APPROVAL DATE

8/2006
PLAN DATE

WZD-100-A

SHEET
3 of 11

File:PW/Doc/RD/T&S/Typ/Dev/Sign MainTraf D/WZD-100-A Rev. 8/21/06 ECH

NOTE: THE ORIGINAL SIGNED COPY IS KEPT ON FILE AT THE MICHIGAN DEPARTMENT OF TRANSPORTATION.

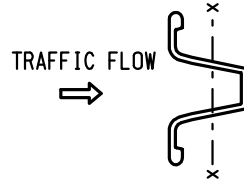
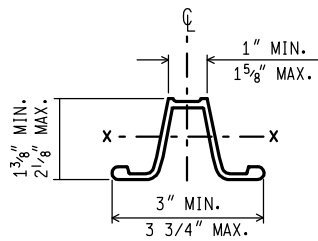
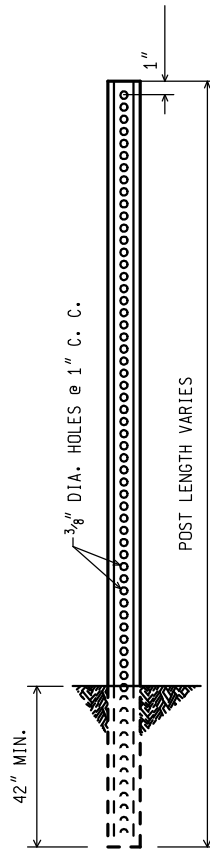

WEIGHT = 3 lbs/ft
 SECT. MOD. X.-X. = 0.31 CUBIC INCHES MIN.

3 lb. U - CHANNEL STEEL POST (NO SPLICE)

MOUNT SIGN ON OPEN FACE OF
 U - CHANNEL STEEL POST

NOT TO SCALE

MICHIGAN DEPARTMENT OF TRANSPORTATION
 BUREAU OF HIGHWAYS DELIVERY STANDARD PLAN

PENDING

 FHWA APPROVAL DATE

8/2006

 PLAN DATE

WZD-100-A

SHEET
 4 of 11

File:PW/Doc/RD/T&S/Typ/Dev/Sign MainTraf D/WZD-100-A Rev. 8/21/06 ECH

NOTE: THE ORIGINAL SIGNED COPY IS KEPT ON FILE AT THE MICHIGAN DEPARTMENT OF TRANSPORTATION.

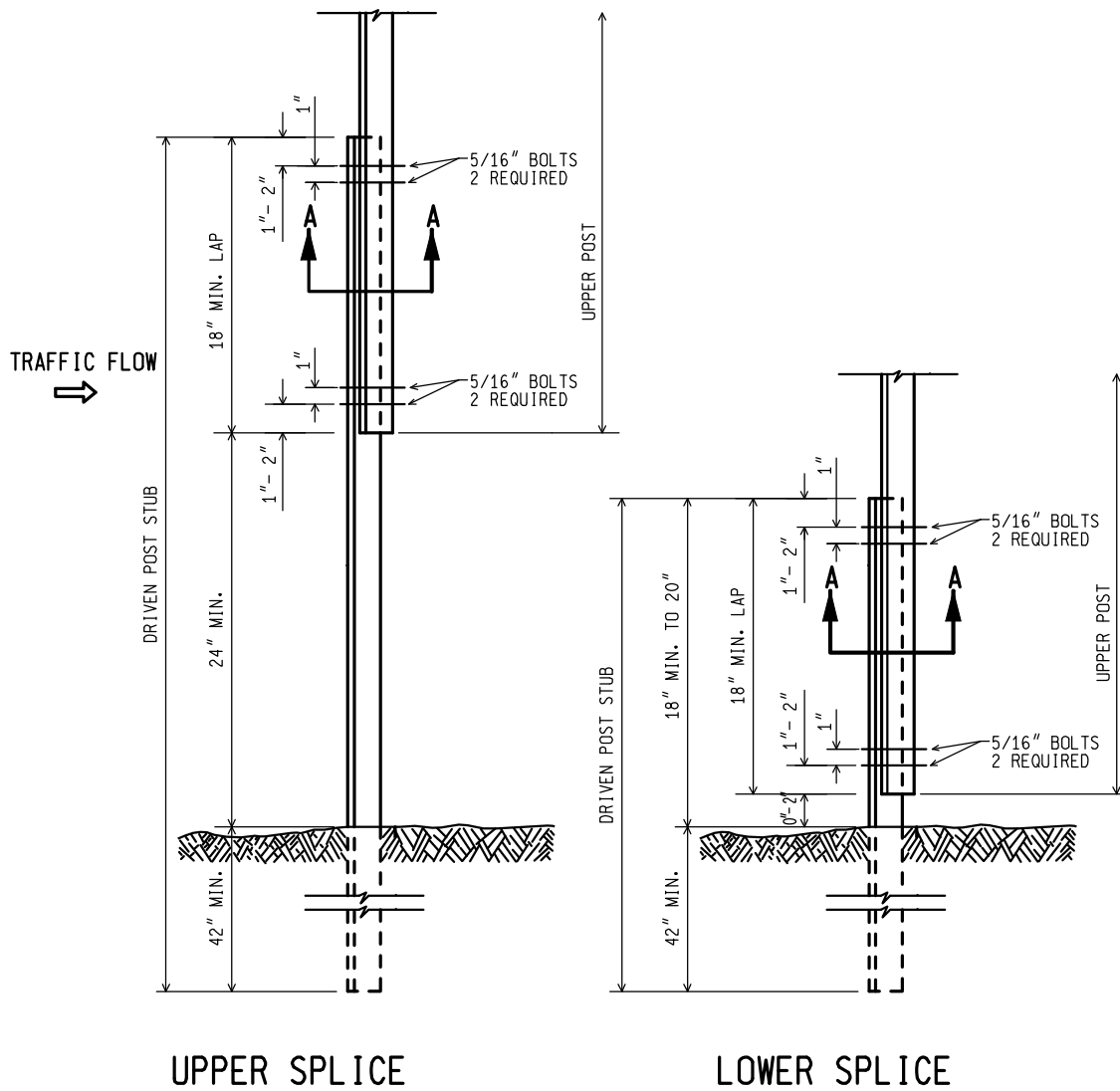

**3 lb. U - CHANNEL STEEL POST
(WITH SPLICE)**

MOUNT SIGN ON OPEN FACE OF
UPPER U - CHANNEL STEEL POST

NOT TO SCALE

MICHIGAN DEPARTMENT OF TRANSPORTATION
BUREAU OF HIGHWAYS DELIVERY STANDARD PLAN

PENDING
FHWA APPROVAL DATE

8/2006
PLAN DATE

WZD-100-A

SHEET
5 of 11

File:PW/Doc/RD/T&S/Typ/Dev/Sign MainTraff D/WZD-100-A Rev. 8/21/06 ECH

NOTE: THE ORIGINAL SIGNED COPY IS KEPT ON FILE AT THE MICHIGAN DEPARTMENT OF TRANSPORTATION.

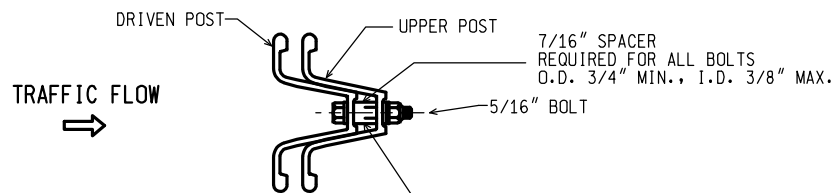

SECTION A-A

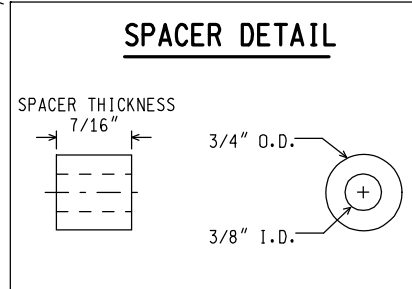

NOTES:

1. THE SPACER THICKNESS SHALL BE 1/16" LESS THAN THE GAP BETWEEN THE POST WHEN POSITIONED IN THE UNBOLTED CONFIGURATION.
2. THE EXTERIOR BOLT (CLOSEST TO LAP), SPACER, WASHER, AND NUT SHALL BE INSTALLED IN A PREPUNCHED HOLE 1" TO 2" FROM THE END OF THE LAP.
3. THE INTERIOR BOLT (FARTHEST FROM LAP), SPACER, WASHER, AND NUT SHALL BE INSTALLED IN THE NEXT PREPUNCHED HOLE.
4. THE DRIVEN POST SHALL ALWAYS BE MOUNTED IN FRONT OF THE UPPER POST WITH RESPECT TO THE ADJACENT ONCOMING TRAFFIC, REGARDLESS OF THE DIRECTION THE SIGN IS FACING.
5. THE SPLICE LAP SHALL BE FASTENED BY FOUR-5/16" DIA. GALVANIZED A449 BOLTS (SAE J429 GRADE 5) OR GALVANIZED A325 BOLTS.

3 1b. U - CHANNEL STEEL POST
(WITH SPLICE)

NOT TO SCALE

| | | | | |
|--|--------------------|--------|-----------|------------------|
| MICHIGAN DEPARTMENT OF TRANSPORTATION BUREAU OF HIGHWAYS DELIVERY STANDARD PLAN | PENDING | 8/2006 | WZD-100-A | SHEET 6 of 11 |
| | FHWA APPROVAL DATE | | | |
| File:PW/Doc/RD/T&S/Typ/Dev/Sign MainTraf D/WZD-100-A Rev. 8/21/06 ECH | | | | |

NOTE: THE ORIGINAL SIGNED COPY IS KEPT ON FILE AT THE MICHIGAN DEPARTMENT OF TRANSPORTATION.

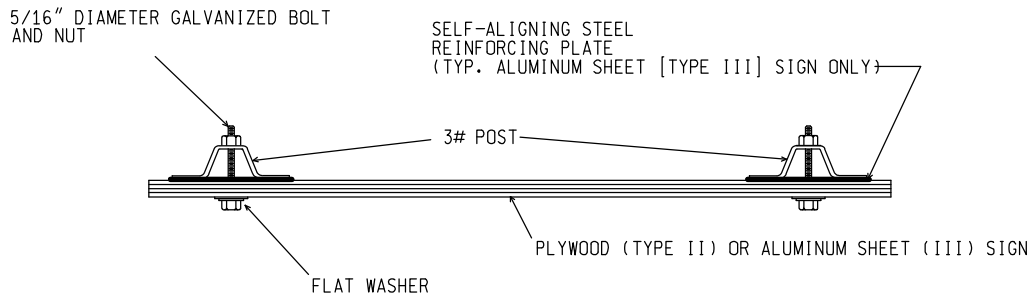

SIGN TO 3 lb. POST CONNECTION

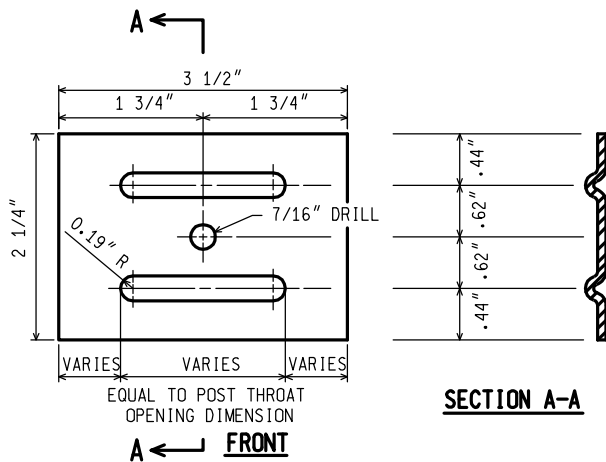

NOTES: (FOR STEEL SIGN REINF' PLATE)

1. MATERIAL: 12 GAUGE CARBON STEEL.
2. TOLERANCE ON ALL DIMENSIONS $\pm 0.0625"$
3. FINISH-AFTER STAMPING AND PUNCHING, GALVANIZE ACCORDING TO CURRENT SPECIFICATIONS FOR ZINC (HOT GALVANIZE) COATINGS ON PRODUCTS FABRICATED FROM PLATES OR STRIPS

STEEL SIGN REINFORCING PLATE
REQUIRED FOR TYPE III SIGNS ONLY

3 lb. U - CHANNEL STEEL POST SIGN CONNECTION

NOT TO SCALE

MICHIGAN DEPARTMENT OF TRANSPORTATION
BUREAU OF HIGHWAYS DELIVERY STANDARD PLAN

PENDING
FHWA APPROVAL DATE

8/2006
PLAN DATE

WZD-100-A

SHEET
7 of 11

File:PW/Doc/RD/T&S/Typ/Dev/Sign MainTraf D/WZD-100-A Rev. 8/21/06 ECH
NOTE: THE ORIGINAL SIGNED COPY IS KEPT ON FILE AT THE MICHIGAN DEPARTMENT OF TRANSPORTATION.

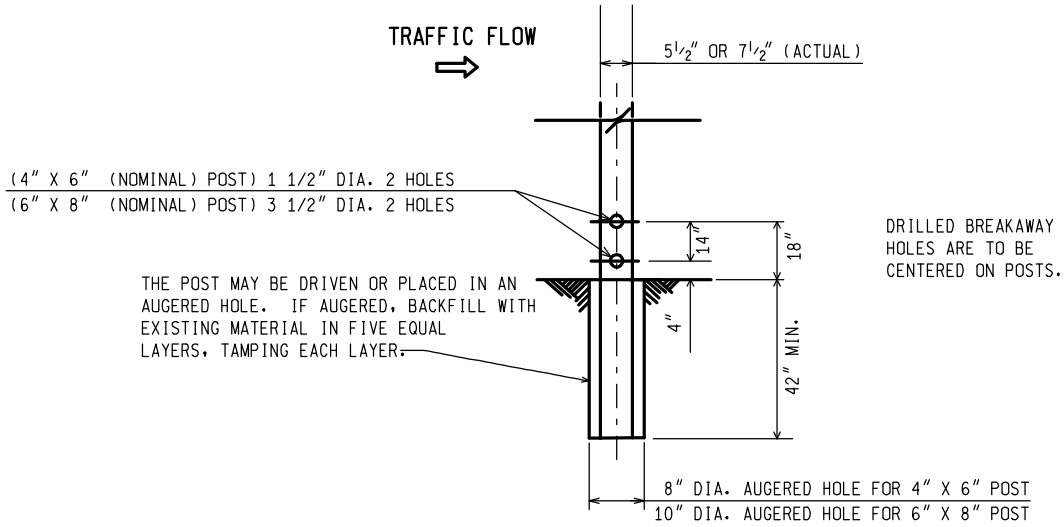

**WOOD POST BREAKAWAY HOLES/
 DIRECT EMBEDMENT DETAILS**

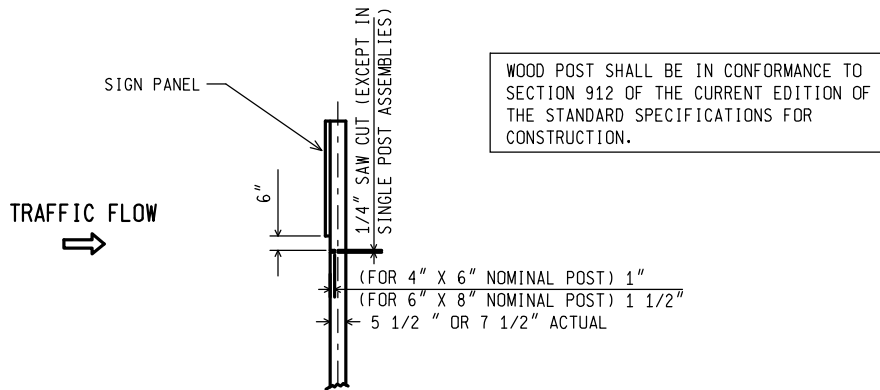

**SAW CUT DETAIL
 (MULTIPLE POST INSTALLATIONS)**

WOOD POST DETAILS

NOT TO SCALE

MICHIGAN DEPARTMENT OF TRANSPORTATION
 BUREAU OF HIGHWAYS DELIVERY STANDARD PLAN

PENDING
 FHWA APPROVAL DATE

8/2006
 PLAN DATE

WZD-100-A

SHEET
 8 of 11

File:PW/Doc/RD/T&S/Typ/Dev/Sign MainTraf D/WZD-100-A Rev. 8/21/06 ECH

NOTE: THE ORIGINAL SIGNED COPY IS KEPT ON FILE AT THE MICHIGAN DEPARTMENT OF TRANSPORTATION.

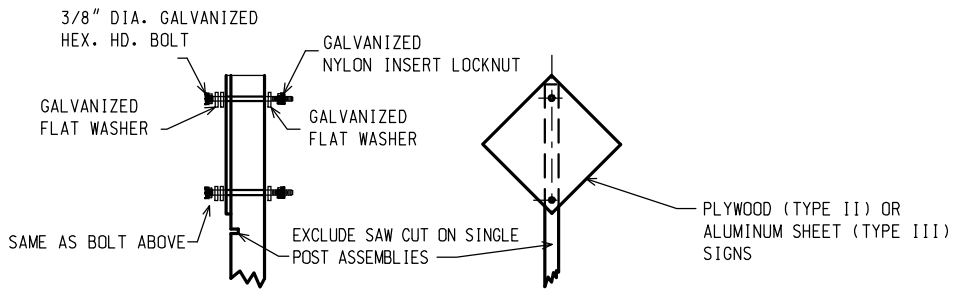

TYPE II AND TYPE III SIGNS

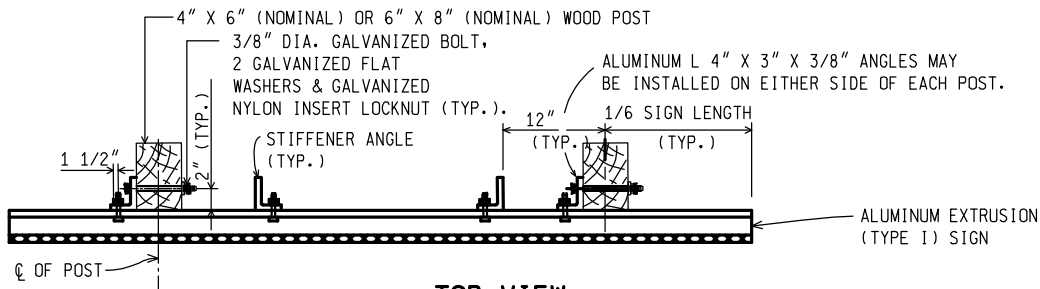

**TOP VIEW
TYPE I SIGN**

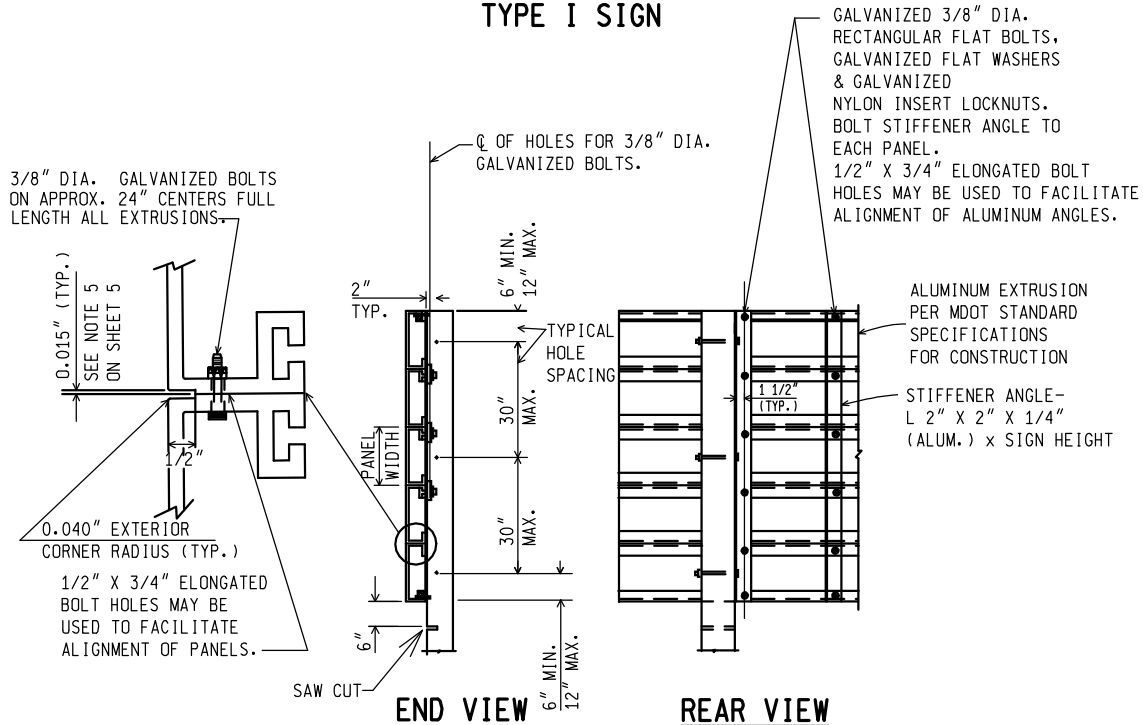

TYPE I SIGN - ERECTION DETAILS

WOOD POST CONNECTIONS

NOT TO SCALE

MICHIGAN DEPARTMENT OF TRANSPORTATION
BUREAU OF HIGHWAYS DELIVERY STANDARD PLAN

PENDING
FHWA APPROVAL DATE

8/2006

WZD-100-A

SHEET
9 of 11

File:PW/Doc/RD/T&S/Typ/Dev/Sign MainTraf D/WZD-100-A Rev. 8/21/06 ECH

PLAN DATE

NOTE: THE ORIGINAL SIGNED COPY IS KEPT ON FILE AT THE MICHIGAN DEPARTMENT OF TRANSPORTATION.

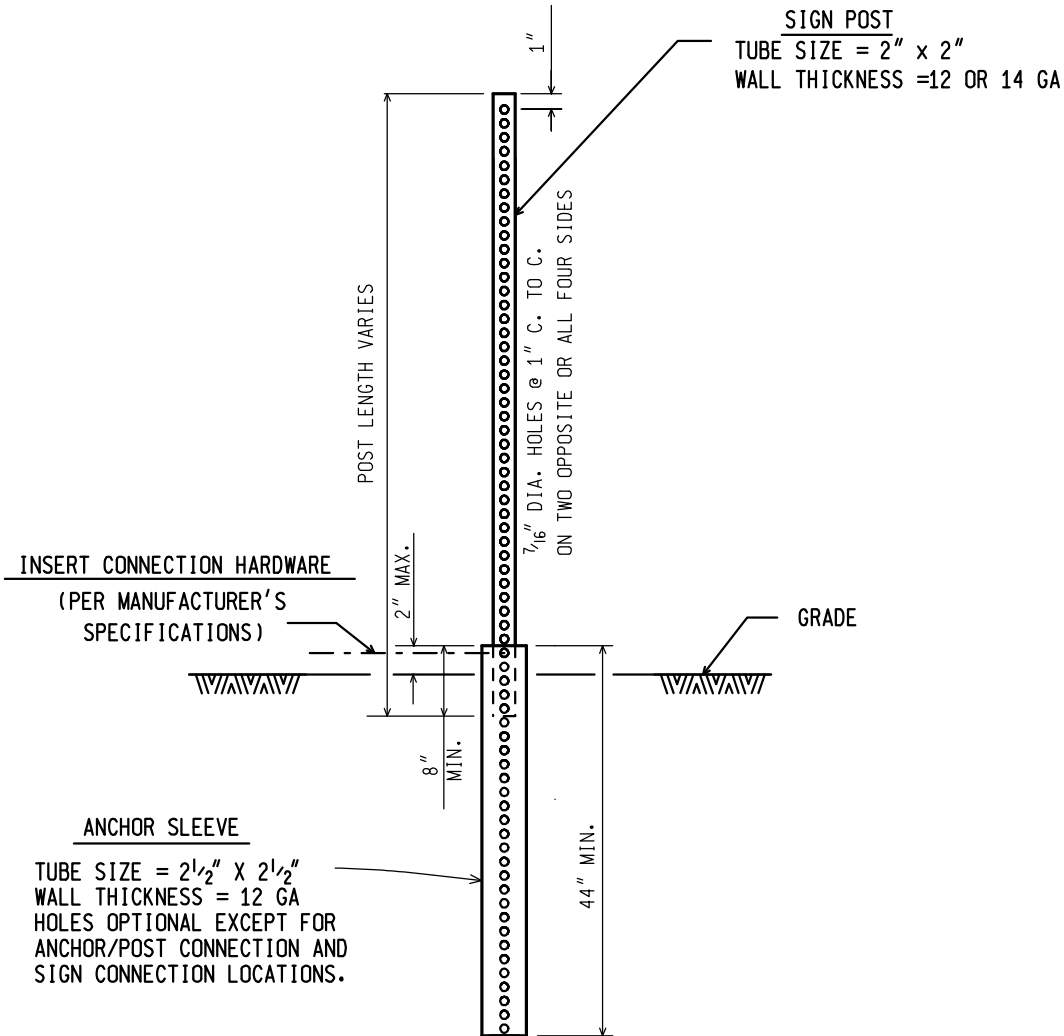

SQUARE TUBULAR STEEL POST

NOT TO SCALE

MICHIGAN DEPARTMENT OF TRANSPORTATION
BUREAU OF HIGHWAYS DELIVERY STANDARD PLAN

PENDING
FHWA APPROVAL DATE

8/2006

WZD-100-A

SHEET
10 of 11

File:PW/Doc/RD/T&S/Typ/Dev/Sign MainTraf D/WZD-100-A Rev. 8/21/06 ECH

PLAN DATE

NOTE: THE ORIGINAL SIGNED COPY IS KEPT ON FILE AT THE MICHIGAN DEPARTMENT OF TRANSPORTATION.

GENERAL NOTES:

1. A MAXIMUM OF TWO POSTS WITHIN A 7 FOOT PATH IS PERMITTED.
2. ALL SIGN POSTS SHALL COMPLY WITH NCHRP 350.
3. ALL POSTS SHALL BE EMBEDDED A MINIMUM OF 42".
4. BRACING OF POST IS NOT PERMITTED.
5. SIGN SHALL BE LEVEL, AND UPRIGHT FOR THE DURATION OF INSTALLATION.
6. ERECT POSTS SO THE SIGN FACE AND SUPPORTS DO NOT VARY FROM PLUMB BY MORE THAN 3/16" IN 3'. PROVIDE A CENTER-TO-CENTER DISTANCE BETWEEN POSTS WITHIN 2 PERCENT OF PLAN DISTANCE.
7. NO MORE THAN ONE SPLICE PER POST, AS SHOWN, WILL BE PERMITTED.
8. POST TYPES SHALL NOT BE MIXED WITHIN A SIGN SUPPORT INSTALLATION.
9. NO VERTICAL JOINTS ARE PERMITTED IN SIGN. NO HORIZONTAL JOINTS THROUGH SIGN LEGEND OR SYMBOLS ARE PERMITTED IN SIGN
10. REMOVE SIGN POSTS AND/OR POST STUBS IN THEIR ENTIRETY WHEN NO LONGER REQUIRED.
11. ALL LABOR, MATERIALS, AND EQUIPMENT, INCLUDING TEMPORARY SUPPORTS REQUIRED TO INSTALL, MAINTAIN, RELOCATE, COVER, AND/OR REMOVE THE TEMPORARY SIGN, INCLUDING SUPPORTS, ARE CONSIDERED TO BE INCLUDED IN THE COST OF THE TEMPORARY SIGN.
12. SAW CUTS IN WOOD POSTS ARE TO BE PARALLEL TO THE BOTTOM OF THE SIGN.
13. POSTS SHALL NOT EXTEND MORE THAN 4" ABOVE TOP OF SIGN.

NOT TO SCALE

| | | | | |
|--|-------------------------------|---------------------|-----------|-------------------|
| MICHIGAN DEPARTMENT OF TRANSPORTATION BUREAU OF HIGHWAYS DELIVERY STANDARD PLAN | PENDING FHWA APPROVAL DATE | 8/2006 PLAN DATE | WZD-100-A | SHEET 11 of 11 |
| File:PW/Doc/RD/T&S/Typ/Dev/Sign MainTraf D/WZD-100-A Rev. 8/21/06 ECH | | | | |

NOTE: THE ORIGINAL SIGNED COPY IS KEPT ON FILE AT THE MICHIGAN DEPARTMENT OF TRANSPORTATION.

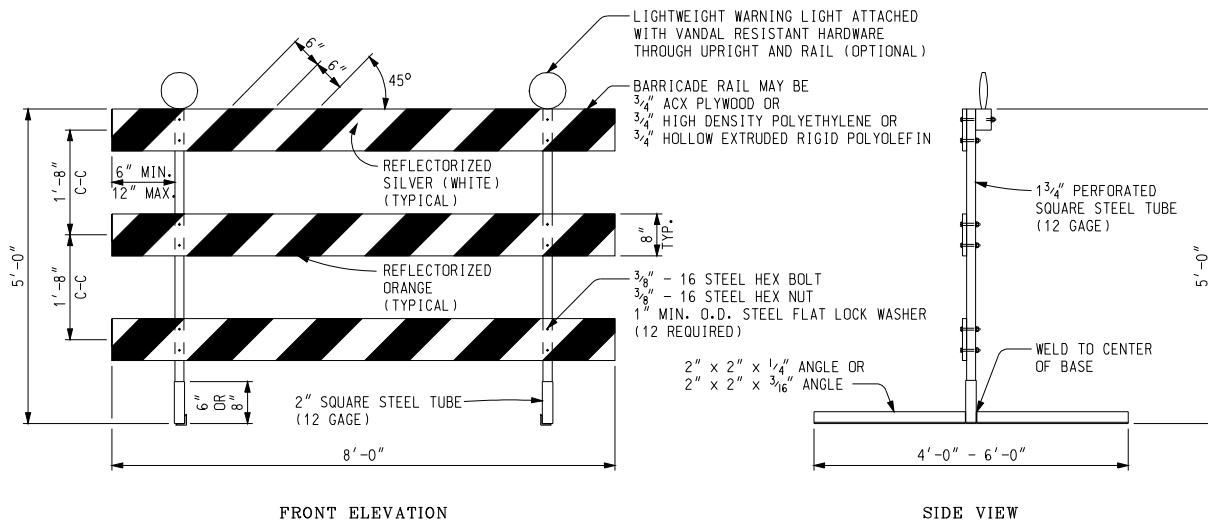

FRONT ELEVATION

SIDE VIEW

PERFORATED SQUARE STEEL TUBE OPTION

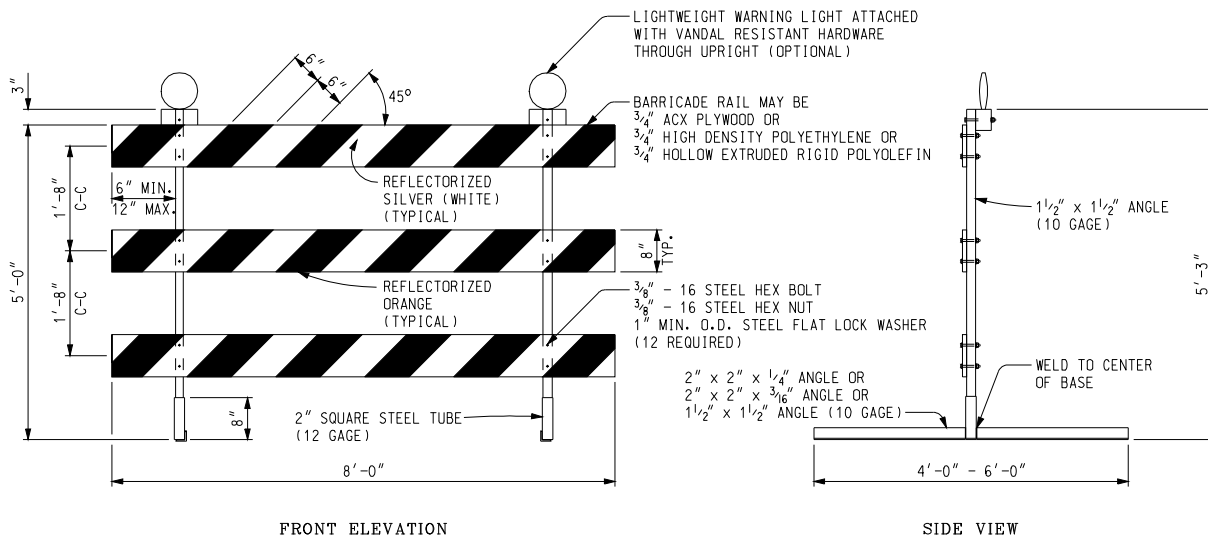

FRONT ELEVATION

SIDE VIEW

ANGLE IRON OPTION

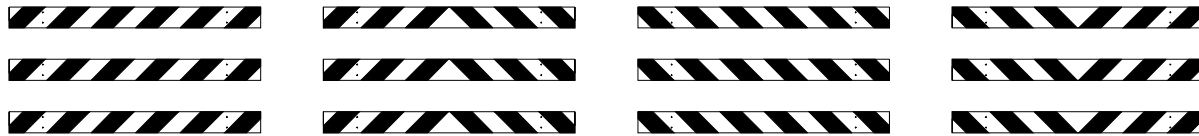

LEFT DIRECTIONAL

BI-DIRECTIONAL

RIGHT DIRECTIONAL

CLOSURES

BARRICADE RAIL SHEETING OPTIONS
TYPE III BARRICADES

Other Type III Barricades meeting current NCHRP crash worthy criteria can be found on the FHWA Safety website at http://safety.fhwa.dot.gov/roadway_dept/road_hardware/wzd.htm

NOT TO SCALE

File: T&S/Typ/Signs/WorkZones/wzd 125 d

Rev. 09/22/09 PJ



PREPARED BY
TRAFFIC AND SAFETY

DRAWN BY: ECH

CHECKED BY: MWB

ENGINEER OF DELIVERY

ENGINEER OF DEVELOPMENT

(SPECIAL DETAIL)

FHWA APPROVAL DATE

MICHIGAN DEPARTMENT OF TRANSPORTATION
BUREAU OF HIGHWAYS DELIVERY STANDARD PLAN FOR

Temporary
Traffic Control Devices

9/22/09
PLAN DATE

WZD-125-E

SHEET
1 of 3

NOTE: THE ORIGINAL SIGNED COPY IS KEPT ON FILE AT THE MICHIGAN DEPARTMENT OF TRANSPORTATION.

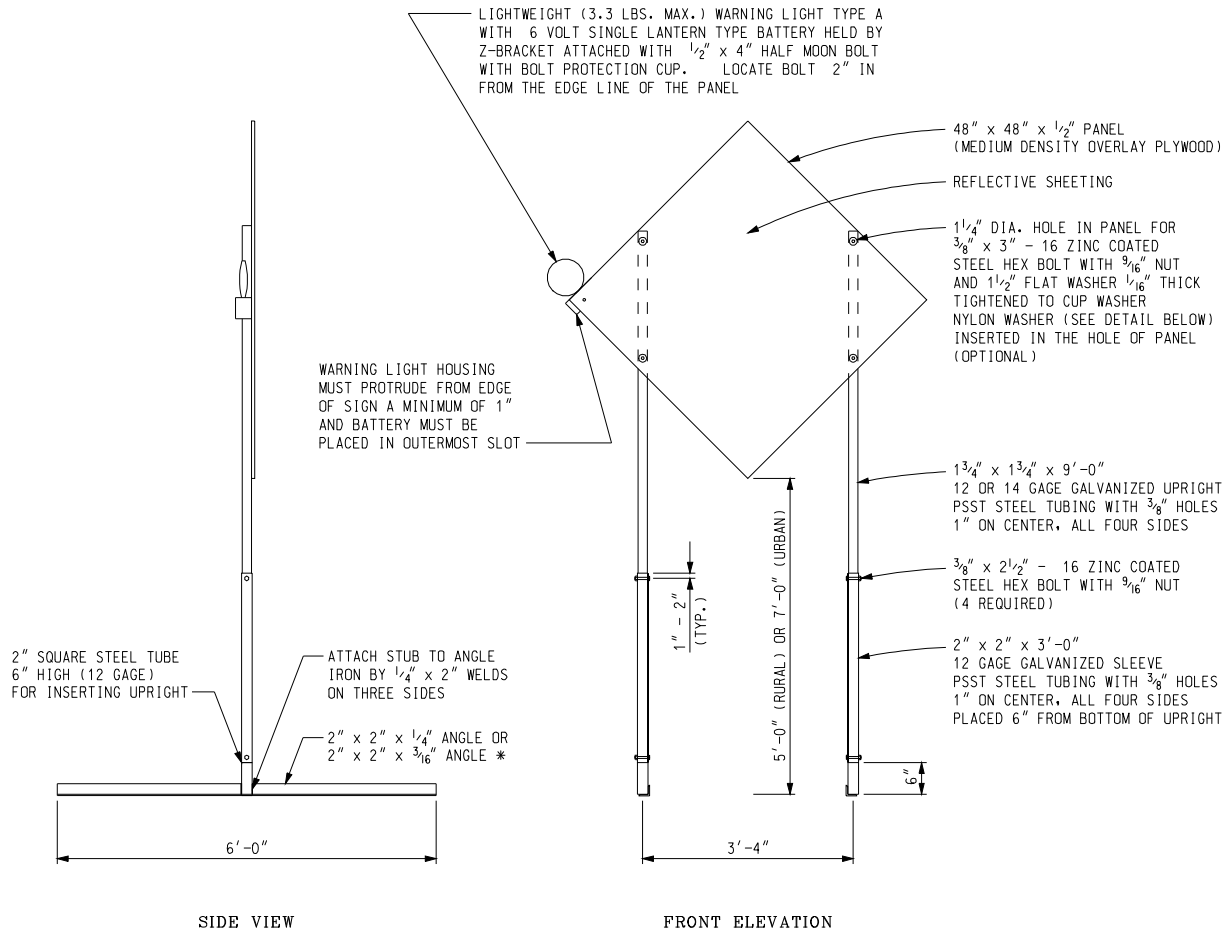

TEMPORARY SIGN SUPPORT

(WARNING LIGHT PLACED ON SIDE CLOSEST TO TRAFFIC)

- * SIGN STAND IS BALLASTED WITH FOUR OR MORE 35 LB SANDBAGS. A MINIMUM OF ONE ON EACH END.
- UPRIGHTS SHALL NOT EXTEND ABOVE THE SIGN PANEL.

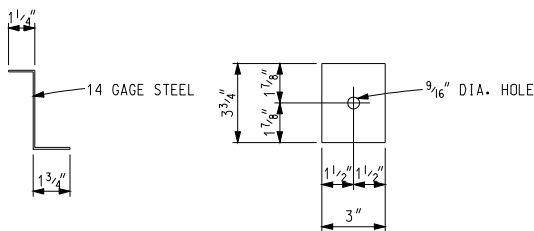

Z-BRACKET DETAIL

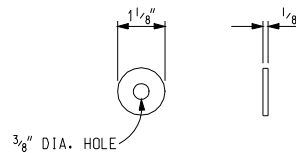

OPTIONAL NYLON WASHER

Other temporary sign supports meeting current NCHRP crash worthy criteria can be found on the FHWA Safety website at http://safety.fhwa.dot.gov/roadway_dept/road_hardware/wzd.htm

NOT TO SCALE

| | | | | |
|--|--|-----------|-----------|-----------------|
| MICHIGAN DEPARTMENT OF TRANSPORTATION BUREAU OF HIGHWAYS DELIVERY STANDARD PLAN | (SPECIAL DETAIL) FHWA APPROVAL DATE | 9/22/09 | WZD-125-E | SHEET 2 of 3 |
| File: T&S/Typ/Signs/WorkZones/wzd 125 d | Rev. 09/22/09 PJ | PLAN DATE | | |

NOTE: THE ORIGINAL SIGNED COPY IS KEPT ON FILE AT THE MICHIGAN DEPARTMENT OF TRANSPORTATION.

- PLASTIC DRUM
- ▲▲▲ PROPOSED TYPE III BARRICADE
- △△△ EXISTING TYPE III BARRICADE

SYMBOLS TO BE USED ON PLANS

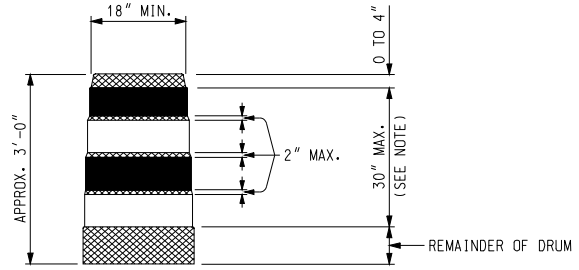

- REFLECTORIZED ORANGE
- REFLECTORIZED WHITE
- ▨ NON REFLECTORIZED ORANGE

NOTE:
 DRUMS SHALL HAVE AT LEAST 4 HORIZONTAL REFLECTORIZED STRIPES (2 ORANGE AND 2 WHITE) OF 6" UNIFORM WIDTH, ALTERNATING IN COLOR WITH THE TOPMOST REFLECTORIZED STRIPE BEING ORANGE. NON REFLECTORIZED SPACES BETWEEN THE HORIZONTAL REFLECTORIZED ORANGE AND WHITE STRIPES SHALL BE ORANGE IN COLOR AND EQUAL IN WIDTH.

PLASTIC DRUM

NOTES:

2" PERFORATED SQUARE STEEL TUBES MAY BE USED TO FABRICATE THE HORIZONTAL BASE OF THE TYPE III BARRICADE.

WARNING LIGHTS SHALL BE PLACED ACCORDING TO THE CURRENT STANDARD SPECIFICATIONS FOR CONSTRUCTION AND ALL OTHER PROVISIONS IN THE CONTRACT WHEN THEY ARE USED ON TYPE III BARRICADES.

SEE ROAD STANDARD PLANS R-113-SERIES FOR TEMPORARY CROSSOVERS FOR DIVIDED ROADWAY, AND R-126-SERIES FOR TYPICAL LOCATION AND SPACING OF PLASTIC DRUMS FOR PLACEMENT OF TEMPORARY CONCRETE BARRIER.

SIGNS, BARRICADES, AND PLASTIC DRUMS SHALL BE FACED WITH PRESSURE-SENSITIVE REFLECTIVE SHEETING ACCORDING TO THE CURRENT STANDARD SPECIFICATIONS FOR CONSTRUCTION.

SANDBAGS SHALL BE USED WHEN SUPPLEMENTAL WEIGHTS ARE REQUIRED TO ACHIEVE STABILITY OF THE BARRICADE. THE SANDBAGS SHALL BE PLACED SO THEY WILL NOT COVER OR OBSTRUCT ANY REFLECTIVE PORTION OF THE TRAFFIC CONTROL DEVICE.

NOT TO SCALE

| | | | | |
|--|--|-----------|-----------|-----------------|
| MICHIGAN DEPARTMENT OF TRANSPORTATION BUREAU OF HIGHWAYS DELIVERY STANDARD PLAN | (SPECIAL DETAIL) FHWA APPROVAL DATE | 9/22/09 | WZD-125-E | SHEET 3 of 3 |
| File: T&S/Typ/Signs/WorkZones/wzd 125 d | Rev. 09/22/09 PJ | PLAN DATE | | |

NOTE: THE ORIGINAL SIGNED COPY IS KEPT ON FILE AT THE MICHIGAN DEPARTMENT OF TRANSPORTATION.

**CITY OF ANN ARBOR
LIVING WAGE ORDINANCE**

RATE EFFECTIVE APRIL 30, 2016 - ENDING APRIL 29, 2017

\$12.93 per hour

If the employer provides health care benefits*

\$14.43 per hour

If the employer does **NOT** provide health care benefits*

Employers providing services to or for the City of Ann Arbor or recipients of grants or financial assistance from the City of Ann Arbor for a value of more than \$10,000 in a twelve-month period of time must pay those employees performing work on a City of Ann Arbor contract or grant, the above living wage.

ENFORCEMENT

The City of Ann Arbor may recover back wages either administratively or through court action for the employees that have been underpaid in violation of the law. Persons denied payment of the living wage have the right to bring a civil action for damages in addition to any action taken by the City.

Violation of this Ordinance is punishable by fines of not more than \$500/violation plus costs, with each day being considered a separate violation. Additionally, the City of Ann Arbor has the right to modify, terminate, cancel or suspend a contract in the event of a violation of the Ordinance.

* Health Care benefits include those paid for by the employer or making an employer contribution toward the purchase of health care. The employee contribution must not exceed \$.50 an hour for an average work week; and the employer cost or contribution must equal no less than \$1/hr for the average work week.

The Law Requires Employers to Display This Poster Where Employees Can Readily See It.

**For Additional Information or to File a Complaint Contact:
Colin Spencer at 734/794-6500 or cspencer@a2gov.org**



Vendor Conflict of Interest Disclosure Form

All vendors interested in conducting business with the City of Ann Arbor must complete and return the Vendor Conflict of Interest Disclosure Form in order to be eligible to be awarded a contract. Please note that all vendors are subject to comply with the City of Ann Arbor's conflict interest policies as stated within the certification section below.

If a vendor has a relationship with a City of Ann Arbor official or employee, an immediate family member of a City of Ann Arbor official or employee, the vendor shall disclose the information required below.

Certification: I hereby certify that to my knowledge, there is no conflict of interest involving the vendor named below:

1. No City official or employee or City employee's immediate family member has an ownership interest in vendor's company or is deriving personal financial gain from this contract.
2. No retired or separated City official or employee who has been retired or separated from the City for less than one (1) year has an ownership interest in vendor's Company.
3. No City employee is contemporaneously employed or prospectively to be employed with the vendor.
4. Vendor hereby declares it has not and will not provide gifts or hospitality of any dollar value or any other gratuities to any City employee or elected official to obtain or maintain a contract.
5. Please note any exceptions below:

| Vendor Name | Vendor Phone Number |
|---|---|
| | |
| Conflict of Interest Disclosure * | |
| Name of City of Ann Arbor employees, elected officials, or immediate family members with whom there maybe a potential conflict of interest. | () Relationship to employee _____ () Interest in vendor's company _____ () Other _____ |
| | |

*Disclosing a potential conflict of interest does not disqualify vendors. In the event vendors do not disclose potential conflicts of interest and they are detected by the City, vendor will be exempt from doing business with the City.

I certify that the information provided is true and correct by my signature below:

Signature of Vendor Authorized Representative Date Printed Name of Vendor Authorized Representative

PROCUREMENT USE ONLY

- Yes, named employee was Involved In Bid / Proposal process.
- No, named employee was not Involved In procurement process or decision.

CITY OF ANN ARBOR NON-DISCRIMINATION ORDINANCE

Relevant provisions of Chapter 112, Nondiscrimination, of the Ann Arbor City Code are included below. You can review the entire ordinance at [www. a2gov.org/departments/city-clerk](http://www.a2gov.org/departments/city-clerk)

Intent: It is the intent of the city that no individual be denied equal protection of the laws; nor shall any individual be denied the enjoyment of his or her civil or political rights or be discriminated against because of actual or perceived age, arrest record, color, disability, educational association, familial status, family responsibilities, gender expression, gender identity, genetic information, height, HIV status, marital status, national origin, political beliefs, race, religion, sex, sexual orientation, source of income, veteran status, victim of domestic violence or stalking, or weight.

Discriminatory Employment Practices: No person shall discriminate in the hire, employment, compensation, work classifications, conditions or terms, promotion or demotion, or termination of employment of any individual. No person shall discriminate in limiting membership, conditions of membership or termination of membership in any labor union or apprenticeship program.

Discriminatory Effects: No person shall adopt, enforce or employ any policy or requirement which has the effect of creating unequal opportunities according to actual or perceived age, arrest record, color, disability, educational association, familial status, family responsibilities, gender expression, gender identity, genetic information, height, HIV status, marital status, national origin, political beliefs, race, religion, sex, sexual orientation, source of income, veteran status, victim of domestic violence or stalking, or weight for an individual to obtain housing, employment or public accommodation, except for a bona fide business necessity. Such a necessity does not arise due to a mere inconvenience or because of suspected objection to such a person by neighbors, customers or other persons.

Nondiscrimination by City Contractors: All contractors proposing to do business with the City of Ann Arbor shall satisfy the contract compliance administrative policy adopted by the City Administrator in accordance with the guidelines of this section. All city contractors shall ensure that applicants are employed and that employees are treated during employment in a manner which provides equal employment opportunity and tends to eliminate inequality based upon any classification protected by this chapter. All contractors shall agree not to discriminate against an employee or applicant for employment with respect to hire, tenure, terms, conditions, or privileges of employment, or a matter directly or indirectly related to employment, because of any applicable protected classification. All contractors shall be required to post a copy of Ann Arbor's Non-Discrimination Ordinance at all work locations where its employees provide services under a contract with the city.

Complaint Procedure: If any individual has a grievance alleging a violation of this chapter, he/she has 180 calendar days from the date of the individual's knowledge of the allegedly discriminatory action or 180 calendar days from the date when the individual should have known of the alleged discriminatory action to file a complaint with the city's Human Rights Commission. If an individual fails to file a complaint alleging a violation of this chapter within the specified time frame, the complaint will not be considered by the Human Rights Commission. The complaint should be made in writing to the Human Rights Commission. The complaint may be filed in person with the City Clerk, by e-mail at aahumanrightscommission@gmail.com, or by mail (Ann Arbor Human Rights Commission, PO Box 8647, Ann Arbor, MI 48107). The complaint must contain information about the alleged discrimination, such as name, address, phone number of the complainant and location, date and description of the alleged violation of this chapter.

Private Actions For Damages or Injunctive Relief: To the extent allowed by law, an individual who is the victim of discriminatory action in violation of this chapter may bring a civil action for appropriate injunctive relief or damages or both against the person(s) who acted in violation of this chapter

THIS IS AN OFFICIAL GOVERNMENT NOTICE AND
MUST BE DISPLAYED WHERE EMPLOYEES CAN READILY SEE IT.