

CITY OF ANN ARBOR
INVITATION TO BID



South Division Street Resurfacing

ITB No. 4419

Due Date: Friday, February 26, 2016, 10:00a.m. (Local Time)

Public Services/Project Management Unit
Administering Service Area/Unit

Issued By:

City of Ann Arbor
Procurement Unit
301 E. Huron Street
Ann Arbor, MI 48104

TABLE OF CONTENTS

TABLE OF CONTENTS.....TC-1
NOTICE OF PRE-BID CONFERENCE.....NP-1
INSTRUCTIONS TO BIDDERS.....IB-1 to 5
INVITATION TO BID.....ITB-1 to 9
CONTRACT.....C-1 to 4
BOND FORMS.....B-1 to 2
GENERAL CONDITIONS.....GC-1 to 18
STANDARD SPECIFICATIONS.....SS-19
DETAILED SPECIFICATION..... DS-1 to 132

APPENDIX..... APDX-1

Appendix A – Soil Borings

ATTACHMENTS

- City of Ann Arbor Prevailing Wage Declaration Form*
- City of Ann Arbor Living Wage Forms*
- City of Ann Arbor Vendor Conflict of Interest Disclosure Form*
- City of Ann Arbor Non-Discrimination Ordinance Notice and Declaration Form*

NOTICE OF PRE-BID CONFERENCE

A pre-bid conference for this project will be held on **Wednesday, February 17, 2016 at 10:00 am** at **Larcom City Hall, 1st Floor Conference Room**.

Attendance at this conference is highly recommended. Administrative and technical questions regarding this project will be answered at this time. The pre-bid conference is for information only. Any answers furnished will not be official until verified in writing by the Financial Service Area, Procurement Unit. Answers that change or substantially clarify the bid will be affirmed in an addendum.

INSTRUCTIONS TO BIDDERS

General

Work to be done under this Contract is generally described through the detailed specifications and must be completed fully in accordance with the contract documents. All work to be done under this Contract is located in or near the City of Ann Arbor.

Any Bid which does not conform fully to these instructions may be rejected.

Preparation of Bids

Bids should be prepared providing a straight-forward, concise description of the Bidder's ability to meet the requirements of the ITB. Bids shall be written in ink or typewritten. No erasures are permitted. Mistakes may be crossed out and corrected and must be initialed and dated in ink by the person signing the Bid.

Bids must be submitted on the "Bid Forms" provided with each blank properly filled in. If forms are not fully completed it may disqualify the bid. No alternative bid will be considered unless alternative bids are specifically requested. If alternatives are requested, any deviation from the specification must be fully described, in detail on the "Alternate" section of Bid form.

Each person signing the Bid certifies that he/she is the person in the Bidder's firm/organization responsible for the decision as to the fees being offered in the Bid and has not and will not participated in any action contrary to the terms of this provision.

Questions or Clarification on ITB Specifications

All questions regarding this ITB shall be submitted via email. Emailed questions and inquires will be accepted from any and all prospective Bidders in accordance with the terms and conditions of the ITB.

All questions shall be due on or before **Monday, February 22, 2016 at 3pm** and should be addressed as follows:

Specification/Scope of Work questions emailed to jnelson@a2gov.org
Bid Process and HR Compliance questions emailed to cspencer@a2gov.org

Any error, omissions or discrepancies in the specification discovered by a prospective contractor and/or service provider shall be brought to the attention of Jennifer Nelson at **jnelson@a2gov.org** after discovery as possible. Further, the contractor and/or service provide shall not be allowed to take advantage of errors, omissions or discrepancies in the specifications.

Addenda

If it becomes necessary to revise any part of the ITB, notice of the Addendum will be posted to Michigan Inter-governmental Trade Network (MITN) www.mitn.info and/or City of Ann Arbor web site www.A2gov.org for all parties to download.

Each Bidder must in its Bid, to avoid any miscommunications, acknowledge all addenda which it has received, but the failure of a Bidder to receive, or acknowledge receipt of; any addenda

shall not relieve the Bidder of the responsibility for complying with the terms thereof.

The City will not be bound by oral responses to inquiries or written responses other than written addenda.

Bid Submission

All Bids are due and must be delivered to the City of Ann Arbor Procurement Unit on or before **Friday, February 26, 2016, 10:00a.m. EST**. Bids submitted late or via oral, telephonic, telegraphic, electronic mail or facsimile **will not** be considered or accepted.

Each Bidder must submit **one (1) original Bid and two (2) Bid** copies in a sealed envelope clearly marked: **ITB No. 4419 – South Division Street Resurfacing**.

Bids must be addressed and delivered to:

City of Ann Arbor
Procurement Unit,
c/o Customer Services, 1st Floor
301 East Huron Street
P.O. Box 8647
Ann Arbor, MI 48107

All Bids received on or before the Due Date will be publicly opened and recorded immediately. No immediate decisions are rendered.

The following forms provided within this ITB Document must be included in submitted bids.

- **City of Ann Arbor Prevailing Wage Declaration of Compliance**
- **City of Ann Arbor Living Wage Ordinance Declaration of Compliance**
- **Vendor Conflict of Interest Disclosure Form**
- **City of Ann Arbor Non-Discrimination Ordinance Declaration of Compliance**

Bids that fail to provide these completed forms listed above upon bid opening will be rejected as non-responsive and will not be considered for award.

Hand delivered bids will be date/time stamped/signed by the Procurement Unit at the address above in order to be considered. Normal business hours are 9:00 a.m. to 3:00 p.m. Monday through Friday, excluding Holidays. The City will not be liable to any Bidder for any unforeseen circumstances, delivery or postal delays. Postmarking to the Due Date will not substitute for receipt of the Bid. Each Bidder is responsible for submission of their Bid.

Additional time for submission of bids past the stated due date and time will not be granted to a single Bidder; however, additional time may be granted to all Bidders when the City determines in its sole discretion that circumstances warrant it.

Award

The City intends to award a Contract(s) to the lowest responsible Bidder(s). On multi-divisional contracts, separate divisions may be awarded to separate Bidders. The City may also utilize alternatives offered in the Bid Forms, if any, to determine the lowest responsible Bidder on each

division, and award multiple divisions to a single Bidder, so that the lowest total cost is achieved for the City. For unit price bids, the Contract will be awarded based upon the unit prices and the lump sum prices stated by the bidder for the work items specified in the bid documents, with consideration given to any alternates selected by the City. If the City determines that the unit price for any item is materially different for the work item bid than either other bidders or the general market, the City, in its sole discretion, in addition to any other right it may have, may reject the bid as not responsible or non-conforming.

The acceptability of major subcontractors will be considered in determining if a Bidder is responsible. In comparing Bids, the City will give consideration to alternate Bids for items listed in the bid forms. All key staff and subcontractors are subject to the approval by the City.

Official Documents

The City of Ann Arbor officially distributes bid documents from the Procurement Unit or through the Michigan Intergovernmental Trade Network (MITN). Copies of the bid documents obtained from any other source are not Official copies. Addenda and other bid information will only be posted to these official distribution sites. If you obtained City of Ann Arbor Bid documents from other sources, it is recommended that you register on www.MITN.info and obtain an official Bid.

Bid Security

Each bid must be accompanied by a certified check, or Bid Bond by a surety licensed and authorized to do business within the State of Michigan, in the amount of 5% of the total of the bid price.

Withdrawal of Bids

After the time of opening, no Bid may be withdrawn for the period of ninety (90) days

Contract Time

Time is of the essence in the performance of the work under this Contract. The available time for work under this Contract is indicated on page C-2, Article III of the Contract. If these time requirements can not be met, the Bidder must stipulate on Bid Form Section 3 - Time Alternate its schedule for performance of the work. Consideration will be given to time in evaluating bids.

Liquidated Damages

A liquidated damages clause, as given on page C-2, Article III of the Contract, provides that the Contractor shall pay the City as liquidated damages, and not as a penalty, a sum certain per day for each and every day that the Contractor may be in default of completion of the specified work, within the time(s) stated in the Contract, or written extensions.

Liquidated damages clauses, as given in the General Conditions, provide further that the City shall be entitled to impose and recover liquidated damages for breach of the obligations under Chapter 112 of the City Code.

The liquidated damages are for the non-quantifiable aspects of any of the previously identified events and do not cover actual damages that can be shown or quantified nor are they intended to preclude recovery of actual damages in addition to the recovery of liquidated damages.

Human Rights Information

All contractors proposing to do business with the City shall satisfy the contract compliance administrative policy adopted by the City Administrator in accordance with the Section 9:158 of the Ann Arbor City Code. Breach of the obligation not to discriminate as outlined in Section 5, beginning at page GC-3 shall be a material breach of the contract. Contractors are required to post a copy of Ann Arbor's Non-Discrimination Ordinance attached at all work locations where its employees provide services under a contract with the City.

Wage Requirements

Section 4, beginning at page GC-2, outlines the requirements for payment of prevailing wages and for payment of a "living wage" to employees providing service to the City under this contract. The successful bidder and its subcontractors must comply with all applicable requirements and provide documentary proof of compliance when requested.

For laborers whose wage level are subject to federal, state and/or local prevailing wage law the appropriate Davis-Bacon wage rate classification is identified based upon the work including within this contract. **The wage determination(s) current on the date 10 days before bids are due shall apply to this contract.** The U.S. Department of Labor (DOL) has provided explanations to assist with classification in the following resource link: www.wdol.gov

Conflict Of Interest Disclosure

The City of Ann Arbor Purchasing Policy requires that prospective Vendors complete a Conflict of Interest Disclosure form. A contract may not be awarded to the selected Vendor unless and until the Procurement Unit and the City Administrator have reviewed the Disclosure form and determined that no conflict exists under applicable federal, state, or local law or administrative regulation. Not every relationship or situation disclosed on the Disclosure Form may be a disqualifying conflict. Depending on applicable law and regulations, some contracts may awarded on the recommendation of the City Administrator after full disclosure, where such action is allowed by law, if demonstrated competitive pricing exists and/or it is determined the award is in the best interest of the City. A copy of the Vendor Conflict of Interest Disclosure Form is attached.

Major Subcontractors

The Bidder shall identify on Bid Form Section 4 each major subcontractor it expects to engage for this Contract if the work to be subcontracted is 15% or more of the bid sum or over \$50,000, whichever is less. The Bidder also shall identify the work to be subcontracted to each major subcontractor. The Bidder shall not change or replace a subcontractor without approval by the City.

Debarment

Submission of a Bid in response to this ITB is certification that the Bidder is not currently debarred, suspended, proposed for debarment, and declared ineligible or voluntarily excluded from participation in this transaction by any State or Federal departments or agency. Submission is also agreement that the City will be notified of any changes in this status.

Disclosures

After bids are opened, all information in a submitter's bid is subjected to disclosure under the provisions of Michigan Public Act No. 442 of 1976, as amended (MCL 15.231 et seq.) known as the "Freedom of Information Act." The Freedom of Information Act also provides for the complete disclosure of contracts and attachments thereto except where specifically exempted.

Bid Protest

All Bid protests must be in writing and filed with the Purchasing Agent within five (5) business days of the award action. The bidder must clearly state the reasons for the protest. If a bidder contacts a City Service Area/Unit and indicates a desire to protest an award, the Service Area/Unit shall refer the bidder to the Purchasing Agent. The Purchasing Agent will provide the bidder with the appropriate instructions for filing the protest. The protest shall be reviewed by the City Administrator or designee whose decision shall be final.

Cost Liability

The City of Ann Arbor assumes no responsibility or liability for costs incurred by the Bidder prior to the execution of a contract with the City. By submitting a bid, a bidder agrees to bear all costs incurred or related to the preparation, submission and selection process for the bid.

Reservation of Rights

The City of Ann Arbor reserves the right to accept any bid or alternative bid proposed in whole or in part, to reject any or all bids or alternatives bids in whole or in part and to waive irregularity and/or informalities in any bid and to make the award in any manner deemed in the best interest of the City.

INVITATION TO BID

City of Ann Arbor
Guy C. Larcom Municipal Building
Ann Arbor, Michigan 48107

Ladies and Gentlemen:

The undersigned, as Bidder, declares that this Bid is made in good faith, without fraud or collusion with any person or persons bidding on the same Contract; that this Bidder has carefully read and examined the bid documents, including City Nondiscrimination requirements and Declaration of Compliance Form, Living Wage requirements and Declaration of Compliance Form, Prevailing Wage requirements and Declaration of Compliance Form, Vendor Conflict of Interest Form, Notice of Pre-Bid Conference, Instructions to Bidders, Bid, Bid Forms, Contract, Bond Forms, General Conditions, Standard Specifications, Detailed Specifications, all Addenda, and the Plans (if applicable) and understands them. The Bidder declares that it conducted a full investigation at the site and of the work proposed and is fully informed as to the nature of the work and the conditions relating to the work's performance. The Bidder also declares that it has extensive experience in successfully completing projects similar to this one.

The Bidder acknowledges that it has not received or relied upon any representations or warrants of any nature whatsoever from the City of Ann Arbor, its agents or employees, and that this Bid is based solely upon the Bidder's own independent business judgment.

The undersigned proposes to perform all work shown on the plans or described in the bid documents, including any addenda issued, and to furnish all necessary machinery, tools, apparatus, and other means of construction to do all the work, furnish all the materials, and complete the work in strict accordance with all terms of the Contract of which this Bid is one part.

In accordance with these bid documents, and Addenda numbered _____, the undersigned, as Bidder, proposes to perform at the sites in and/or around Ann Arbor, Michigan, all the work included herein for the amounts set forth in the Bid Forms.

The Bidder declares that it has become fully familiar with the liquidated damage clauses for completion times and for compliance with City Code Chapter 112, understands and agrees that the liquidated damages are for the non-quantifiable aspects of non-compliance and do not cover actual damages that may be shown and agrees that if awarded the Contract, all liquidated damage clauses form part of the Contract.

The Bidder declares that it has become fully familiar with the provisions of Chapter 14, Section 1:320 (Prevailing wages) and Chapter 23 (Living Wage) of the Code of the City of Ann Arbor and that it understands and agrees to comply, to the extent applicable to employees providing services to the City under this Contract, with the wage and reporting requirements stated in the City Code provisions cited. Bidder certifies that the statements contained in the City Prevailing Wage and Living Wage Declaration of Compliance Forms are true and correct. Bidder further agrees that the cited provisions of Chapter 14 and Chapter 23 form a part of this Contract.

The Bidder declares that it has become familiar with the City Conflict of Interest Disclosure Form and certifies that the statement contained therein is true and correct.

The Bidder encloses a certified check or Bid Bond in the amount of 5% of the total of the Bid Price. The Bidder agrees both to contract for the work and to furnish the necessary Bonds and insurance documentation within 10 days after being notified of the acceptance of the Bid.

If this Bid is accepted by the City and the Bidder fails to contract and furnish the required Bonds and insurance documentation within 10 days after being notified of the acceptance of this Bid, then the Bidder shall be considered to have abandoned the Contract and the certified check or Bid Bond accompanying this Bid shall become due and payable to the City.

If the Bidder enters into the Contract in accordance with this Bid, or if this Bid is rejected, then the accompanying check or Bid Bond shall be returned to the Bidder.

In submitting this Bid, it is understood that the right is reserved by the City to accept any Bid, to reject any or all Bids, to waive irregularities and/or informalities in any Bid, and to make the award in any manner the City believes to be in its best interest.

SIGNED THIS _____ DAY OF _____, 201_.

Bidder's Name

Authorized Signature of Bidder

Official Address

(Print Name of Signer Above)

Telephone Number

Email Address for Award Notice

LEGAL STATUS OF BIDDER

(The Bidder shall fill out the appropriate form and strike out the other three.)

Bidder declares that it is:

* A corporation organized and doing business under the laws of the State of _____, for whom _____, bearing the office title of _____, whose signature is affixed to this Bid, is authorized to execute contracts.

NOTE: If not incorporated in Michigan, please attach the corporation's Certificate of Authority

• A limited liability company doing business under the laws of the State of _____, whom _____ bearing the title of _____ whose signature is affixed to this proposal, is authorized to execute contract on behalf of the LLC.

* A partnership, organized under the laws of the state of _____ and filed in the county of _____, whose members are (list all members and the street and mailing address of each) (attach separate sheet if necessary):

* An individual, whose signature with address, is affixed to this Bid: _____
(initial here)

Authorized Official

_____ **Date** _____, 201_

(Print) Name _____ Title _____

Company: _____

Address: _____

Contact Phone () _____ Fax () _____

Email _____

BID FORM
Section 1 - Schedule of Prices
Project: **ITB 4419 - South Division Street Resurfacing**

LINE	DESCRIPTION	UNIT	ESTIMATED QUANTITY	UNIT PRICE	AMOUNT (\$)
1	General Conditions, Maximum \$60,000	LS	1	\$	
2	Project Supervision, Maximum \$15,000	LS	1	\$	
3	Audiovisual Tape Coverage	LS	1	\$	
4	Storm Sewer Pipe, Less than 24 Inch, Remove	Ft	64	\$	
5	Storm Sewer Structure, Remove	Ea	8	\$	
6	Water Main Pipe, 6 Inch, Abandonment	Ft	565	\$	
7	Water Main Pipe, 12 Inch, Abandonment	Ft	10	\$	
8	6 Gate Valve In Box, Abandon	Ea	2	\$	
9	12 Gate Valve In Box, Abandon	Ea	1	\$	
10	Remove Concrete Pavement - Any Thickness	Syd	1937	\$	
11	Remove Concrete Curb & Gutter - Any Type	Ft	1989	\$	
12	Remove Concrete Sidewalk - Any Thickness	Sft	3275	\$	
13	Embankment, CIP	Cyd	239	\$	
14	Excavation, Earth	Cyd	345	\$	
15	Granular Material, CI II	Cyd	138	\$	
16	Exploratory Excavation (0-10' Deep) Tr Det I	Ea	5	\$	
17	Erosion Control, Inlet Protection, Fabric Drop	Ea	17	\$	
18	Aggregate Base, 8 Inch, 21AA	Syd	2185	\$	
19	Storm Sewer, RCP, 12 Inch & SD-TR- I	Ft	72	\$	
20	Single Inlet	Ea	6	\$	
21	Structure Cover	Lb	12000	\$	
22	Adjust Structure Cover	Ea	57	\$	
23	Adjust Monument Box	Ea	5	\$	
24	Adjust Gate Valve Box	Ea	23	\$	
25	Temp Lowering Existing Structure	Ea	57	\$	
26	Temp Lowering Existing Box	Ea	28	\$	

Total This Page \$ _____

BID FORM
Section 1 - Schedule of Prices
Project: **ITB 4419 - South Division Street Resurfacing**

LINE	DESCRIPTION	UNIT	ESTIMATED QUANTITY	UNIT PRICE	AMOUNT (\$)
27	Point Existing Structure	Ea	5	\$	
28	Pavement Joint and Crack Repair – Detail 7	Ft	240	\$	
29	Pavement Joint and Crack Repair – Detail 8	Ft	120	\$	
30	HMA, 3E3	Ton	316	\$	
31	HMA, 4E3	Ton	1512	\$	
32	HMA, 5E3	Ton	942	\$	
33	Geosynthetic Paving Layer	Syd	9929	\$	
34	Cold Milling Bituminous Pavement	Ton	3768	\$	
35	HMA Surface, Rem	Syd	1457	\$	
36	Hand Patching, HMA LVSP	Ton	346	\$	
37	HMA, Wedging, 36A	Ton	21	\$	
38	Curb & Gutter, Conc, Barrier	Ft	1827	\$	
39	Drive Opening, Conc, Type M	Ft	262	\$	
40	Sidewalk, Conc, 8 Inch	Sft	3562	\$	
41	Sidewalk Ramp, Conc, 8 Inch	Sft	1058	\$	
42	Detectable Warning Surface	Sft	160	\$	
43	Detectable Warning Surface, Cast Iron	Sft	80	\$	
44	Protective Fence	Ft	1000	\$	
45	Pavt Mrkg, Hot-Applied, Thermoplastic, 4 Inch White	Ft	910	\$	
46	Pavt Mrkg, Hot-Applied, Thermoplastic, 4 Inch Yellow	Ft	314	\$	
47	Pavt Mrkg, Hot-Applied, Thermoplastic, 6 Inch White	Ft	1903	\$	
48	Pavt Mrkg, Hot-Applied, Thermoplastic, Symbol White, 24 Crosswalk	Ft	878	\$	
49	Pavt Mrkg, Hot-Applied, Thermoplastic, Symbol White, 24 Stop Bar	Ft	403	\$	
50	Pavt Mrkg, Overlay Cold Plastic, Legend White, Only	Ea	4	\$	
51	Pavt Mrkg, Overlay Cold Plastic, Symbol White, Bike Arrow	Ea	7	\$	
52	Pavt Mrkg, Overlay Cold Plastic, Symbol White, Bike Sym	Ea	10	\$	

Total This Page \$ _____

BID FORM
Section 1 - Schedule of Prices
Project: **ITB 4419 - South Division Street Resurfacing**

LINE	DESCRIPTION	UNIT	ESTIMATED QUANTITY	UNIT PRICE	AMOUNT (\$)
	Pavt Mrkg, Overlay Cold Plastic, Symbol White,				
53	Left Arrow	Ea	2	\$	
	Pavt Mrkg, Overlay Cold Plastic, Symbol White,				
54	Right Arrow	Ea	1	\$	
	Pavt Mrkg, Overlay Cold Plastic, Symbol White,				
55	Sharrow	Ea	3	\$	
	Pavt Mrkg, Overlay Cold Plastic, Symbol White,				
56	Thru Arrow	Ea	1	\$	
57	Recessed Pavt Mrkg, Thermoplastic, Parking	Ea	82	\$	
58	Recessing Pavement Markings Longitudinal	Ft	3127	\$	
59	Recessing Pavement Markings Transverse	Sft	2144	\$	
60	Recessing Special Pavement Markings	Sft	630	\$	
61	Minor Traffic Control, Maximum \$2,000	LS	1	\$	
62	Traffic Regulator Control	LS	1	\$	
63	Sign, Type B, Temp, Prismatic, Furn	Sft	1118.5	\$	
64	Sign, Type B, Temp, Prismatic, Oper	Sft	1118.5	\$	
65	Sign, Type B, Temp, Prismatic, Special, Furn	Sft	50	\$	
66	Sign, Type B, Temp, Prismatic, Special, Oper	Sft	50	\$	
67	Sign Cover	Ea	16	\$	
68	Lighted Arrow, Type C, Furn	Ea	2	\$	
69	Lighted Arrow, Type C, Oper	Ea	2	\$	
70	Sign, Portable, Changeable Message, Furn	Ea	4	\$	
71	Sign, Portable, Changeable Message, Oper	Ea	4	\$	
72	Plastic Drum, High Intensity, Lighted, Furn	Ea	183	\$	
73	Plastic Drum, High Intensity, Lighted, Oper	Ea	183	\$	
74	Channelizing Device, 42 inch, Furn	Ea	48	\$	
75	Channelizing Device, 42 inch, Oper	Ea	48	\$	
	Barricade, Type III, High Intensity, Double Sided,				
76	Lighted, Furn	Ea	7	\$	
	Barricade, Type III, High Intensity, Double Sided,				
77	Lighted, Oper	Ea	7	\$	
78	Pavt Mrkg, Temp, Type R, 24 Inch, White	Ft	420	\$	

Total This Page \$ _____

BID FORM
Section 1 - Schedule of Prices
Project: **ITB 4419 - South Division Street Resurfacing**

LINE	DESCRIPTION	UNIT	ESTIMATED QUANTITY	UNIT PRICE	AMOUNT (\$)
79	Slope Restoration	Syd	143	\$	
80	Project Clean-Up	LS	1	\$	
81	Handhole Assembly, 12 Inch X 18 Inch	Ea	2	\$	
82	Handhole Assembly, 17 Inch X 30 Inch	Ea	2	\$	
83	Handhole Assembly, 24 Inch X 36 Inch	Ea	2	\$	
84	Class 50 DIP W/ Polyethylene Wrap, 4 Inch & SD- TR- I	Ft	10	\$	
85	Class 50 DIP W/ Polyethylene Wrap, 6 Inch & SD- TR- I	Ft	18	\$	
86	Class 50 DIP W/ Polyethylene Wrap, 8 Inch & SD- TR- I	Ft	54	\$	
87	Class 50 DIP W/ Polyethylene Wrap, 12 Inch & SD- TR- I	Ft	118	\$	
88	DIP, 8 Inch 45 Degree Bend	Ea	2	\$	
89	DIP, 8 Inch 22.5 Degree Bend	Ea	2	\$	
90	DIP, 12 Inch 45 Degree Bend	Ea	2	\$	
91	DIP, 12 Inch 22.5 Degree Bend	Ea	2	\$	
92	DIP, 6 X 8 Reducer	Ea	1	\$	
93	DIP, 6 X 12 Reducer	Ea	1	\$	
94	DIP, 6 X 6 X 6 Tee	Ea	1	\$	
95	DIP, 8 X 12 X 12 Tee	Ea	1	\$	
96	12 Gate Valve In Well Excavate & Backfill For Water Service Tap And	Ea	2	\$	
97	Lead	Ft	590	\$	
98	Fire Hydrant Assembly	Ea	1	\$	
99	Fire Hydrant Assembly, Remove	Ea	1	\$	
100	Line Stop, 4 Inch, Temp	Ea	2	\$	
101	Line Stop, 6 Inch, Temp	Ea	3	\$	
102	SDR 35 PVC Sanitary Service Lead, 4 Inch	Ft	88	\$	

Total This Page \$ _____

BID FORM
Section 1 - Schedule of Prices
Project: ITB 4419 - South Division Street Resurfacing

Total From BF-1 \$ _____

Total From BF-2 \$ _____

Total From BF-3 \$ _____

Total From BF-4 \$ _____

Total Base Bid \$ _____

BID FORM

Section 2 - Material and Equipment Alternates

The Base Bid proposal price shall include materials and equipment selected from the designated items and manufacturers listed in the bidding documents. This is done to establish uniformity in bidding and to establish standards of quality for the items named.

If the Contractor wishes to quote alternate items for consideration by the City, it may do so under this Section. A complete description of the item and the proposed price differential must be provided. Unless approved at the time of award, substitutions where items are specifically named will be considered only as a negotiated change in Contract Sum.

<u>Item Number</u>	<u>Description</u>	<u>Add/Deduct Amount</u>
--------------------	--------------------	--------------------------

If the Bidder does not suggest any material or equipment alternate, the Bidder **MUST** complete the following statement:

For the work outlined in this request for bid, the bidder does NOT propose any material or equipment alternate under the Contract.

Signature of Authorized Representative of Bidder _____ Date _____

BID FORM

Section 3 - Time Alternate

If the Bidder takes exception to the time stipulated in Article III of the Contract, Time of Completion, page C-2, it is requested to stipulate below its proposed time for performance of the work. Consideration will be given to time in evaluating bids.

If the Bidder does not suggest any time alternate, the Bidder **MUST** complete the following statement:

For the work outlined in this request for bid, the bidder does NOT propose any time alternate under the Contract.

Signature of Authorized Representative of Bidder _____ Date _____

BID FORM

Section 4 - Major Subcontractors

For purposes of this Contract, a Subcontractor is anyone (other than the Contractor) who performs work (other than or in addition to the furnishing of materials, plans or equipment) at or about the construction site, directly or indirectly for or on behalf of the Contractor (and whether or not in privity of Contract with the Contractor), but shall not include any individual who furnishes merely the individual's own personal labor or services.

For the work outlined in these documents the Bidder expects to engage the following major subcontractors to perform the work identified:

<u>Subcontractor (Name and Address)</u>	<u>Work</u>	<u>Amount</u>
---	-------------	---------------

If the Bidder does not expect to engage any major subcontractor, the Bidder **MUST** complete the following statement:

For the work outlined in this request for bid, the bidder does NOT expect to engage any major subcontractor to perform work under the Contract.

Signature of Authorized Representative of Bidder _____ Date _____

SAMPLE STANDARD CONTRACT

If a contract is awarded, the selected contractor will be required to adhere to a set of general contract provisions which will become a part of any formal agreement. These provisions are general principles which apply to all contractors of service to the City of Ann Arbor such as the following:

CONTRACT

THIS AGREEMENT is made on the _____ day of _____, 2016, between the CITY OF ANN ARBOR, a Michigan Municipal Corporation, 301 East Huron Street, Ann Arbor, Michigan 48104 ("City") and _____ ("Contractor")

(An individual/partnership/corporation, include state of incorporation)

(Address)

Based upon the mutual promises below, the Contractor and the City agree as follows:

ARTICLE I - Scope of Work

The Contractor agrees to furnish all of the materials, equipment and labor necessary; and to abide by all the duties and responsibilities applicable to it for the project titled "**ITB 4419 – South Division Street Resurfacing**" in accordance with the requirements and provisions of the following documents, including all written modifications incorporated into any of the documents, which are incorporated as part of this Contract:

Non-discrimination and Living Wage Declaration of Compliance Forms (if applicable)
Vendor Conflict of Interest Form
Prevailing Wage Declaration of Compliance Form (if applicable)
Bid Forms
Contract and Exhibits
Bonds

General Conditions
Standard Specifications
Detailed Specifications
Plans
Addenda

ARTICLE II - Definitions

Administering Service Area/Unit means **Public Services/Project Management Services Unit**

Project means **ITB 4419 – South Division Street Resurfacing**

ARTICLE III - Time of Completion

- (A) The work to be completed under this Contract shall begin immediately on the date specified in the Notice to Proceed issued by the City.
- (B) The entire work for this Contract shall be completed within eight four (84) consecutive calendar days.
- (C) Failure to complete all the work within the time specified above, including any extension granted in writing by the Supervising Professional, shall obligate the Contractor to pay the City, as liquidated damages and not as a penalty, an amount equal to \$1,000 for each calendar day of delay in the completion of all

the work. If any liquidated damages are unpaid by the Contractor, the City shall be entitled to deduct these unpaid liquidated damages from the monies due the Contractor.

The liquidated damages are for the non-quantifiable aspects of any of the previously identified events and do not cover actual damages that can be shown or quantified nor are they intended to preclude recovery of actual damages in addition to the recovery of liquidated damages.

ARTICLE IV - The Contract Sum

- (A) The City shall pay to the Contractor for the performance of the Contract, the unit prices as given in the Bid Form for the estimated bid total of:

_____ Dollars (\$_____)

- (B) The amount paid shall be equitably adjusted to cover changes in the work ordered by the Supervising Professional but not required by the Contract Documents. Increases or decreases shall be determined only by written agreement between the City and Contractor.

ARTICLE V - Assignment

This Contract may not be assigned or subcontracted without the written consent of the City.

ARTICLE VI - Choice of Law

This Contract shall be construed, governed, and enforced in accordance with the laws of the State of Michigan. By executing this agreement, the Contractor and the City agree to venue in a court of appropriate jurisdiction sitting within Washtenaw County for purposes of any action arising under this Contract. The parties stipulate that the venue referenced in this Contract is for convenience and waive any claim of non-convenience.

Whenever possible, each provision of the Contract will be interpreted in a manner as to be effective and valid under applicable law. The prohibition or invalidity, under applicable law, of any provision will not invalidate the remainder of the Contract.

ARTICLE VII - Relationship of the Parties

The parties of the Contract agree that it is not a Contract of employment but is a Contract to accomplish a specific result. Contractor is an independent Contractor performing services for the City. Nothing contained in this Contract shall be deemed to constitute any other relationship between the City and the Contractor.

Contractor certifies that it has no personal or financial interest in the project other than the compensation it is to receive under the Contract. Contractor certifies that it is not, and shall not become, overdue or in default to the City for any Contract, debt, or any other obligation to the City including real or personal property taxes. City shall have the right to set off any such debt against compensation awarded for services under this agreement.

ARTICLE VIII - Notice

All notices given under this Contract shall be in writing, and shall be by personal delivery or by certified mail with return receipt requested to the parties at their respective addresses as specified in the Contract Documents or other address the Contractor may specify in writing.

ARTICLE IX - Indemnification

To the fullest extent permitted by law, Contractor shall indemnify, defend and hold harmless the City, its officers, employees and agents harmless from all suits, claims, judgments and expenses including attorney’s fees resulting or alleged to result, in whole or in part, from any act or omission, which is in any way connected or associated with this Contract, by the Contractor or anyone acting on the Contractor’s behalf under this Contract. Contractor shall not be responsible to indemnify the City for losses or damages caused by or resulting from the City’s sole negligence.

ARTICLE X - Entire Agreement

This Contract represents the entire understanding between the City and the Contractor and it supersedes all prior representations or agreements whether written or oral. Neither party has relied on any prior representations in entering into this Contract. This Contract may be altered, amended or modified only by written amendment signed by the City and the Contractor.

FOR CONTRACTOR

By _____

Its: _____

FOR THE CITY OF ANN ARBOR

By _____
Christopher Taylor, Mayor

By _____
Jacqueline Beaudry, City Clerk

Approved as to substance

By _____
City Administrator

By _____
Services Area Administrator

Approved as to form and content

Stephen K. Postema, City Attorney

PERFORMANCE BOND

- (1) _____ of _____ (referred to as "Principal"), and _____, a corporation duly authorized to do business in the State of Michigan (referred to as "Surety"), are bound to the City of Ann Arbor, Michigan (referred to as "City"), for \$ _____, the payment of which Principal and Surety bind themselves, their heirs, executors, administrators, successors and assigns, jointly and severally, by this bond.
- (2) The Principal has entered a written Contract with the City dated _____, 201_, for: _____ and _____ this bond is given for that Contract in compliance with Act No. 213 of the Michigan Public Acts of 1963, as amended, being MCL 129.201 et seq.
- (3) Whenever the Principal is declared by the City to be in default under the Contract, the Surety may promptly remedy the default or shall promptly:
- (a) complete the Contract in accordance with its terms and conditions; or
 - (b) obtain a bid or bids for submission to the City for completing the Contract in accordance with its terms and conditions, and upon determination by Surety of the lowest responsible bidder, arrange for a Contract between such bidder and the City, and make available, as work progresses, sufficient funds to pay the cost of completion less the balance of the Contract price; but not exceeding, including other costs and damages for which Surety may be liable hereunder, the amount set forth in paragraph 1.
- (4) Surety shall have no obligation to the City if the Principal fully and promptly performs under the Contract.
- (5) Surety agrees that no change, extension of time, alteration or addition to the terms of the Contract or to the work to be performed thereunder, or the specifications accompanying it shall in any way affect its obligations on this bond, and waives notice of any such change, extension of time, alteration or addition to the terms of the Contract or to the work, or to the specifications.

SIGNED AND SEALED this _____ day of _____, 201_.

(Name of Surety Company)
By _____
(Signature)
Its _____
(Title of Office)

(Name of Principal)
By _____
(Signature)
Its _____
(Title of Office)

Approved as to form:

Name and address of agent:

Stephen K. Postema, City Attorney

LABOR AND MATERIAL BOND

- (1) _____
of _____ (referred to as "Principal"), and _____, a corporation duly authorized to do business in the State of Michigan, (referred to as "Surety"), are bound to the City of Ann Arbor, Michigan (referred to as "City"), for the use and benefit of claimants as defined in Act 213 of Michigan Public Acts of 1963, as amended, being MCL 129.201 et seq., in the amount of \$ _____, for the payment of which Principal and Surety bind themselves, their heirs, executors, administrators, successors and assigns, jointly and severally, by this bond.
- (2) The Principal has entered a written Contract with the City, dated _____, 201_, for _____; and this bond is given for that Contract in compliance with Act No. 213 of the Michigan Public Acts of 1963 as amended;
- (3) If the Principal fails to promptly and fully repay claimants for labor and material reasonably required under the Contract, the Surety shall pay those claimants.
- (4) Surety's obligations shall not exceed the amount stated in paragraph 1, and Surety shall have no obligation if the Principal promptly and fully pays the claimants.

SIGNED AND SEALED this _____ day of _____, 201_

(Name of Surety Company)
By _____
(Signature)
Its _____
(Title of Office)

(Name of Principal)
By _____
(Signature)
Its _____
(Title of Office)

Approved as to form:

Name and address of agent:

Stephen K. Postema, City Attorney

GENERAL CONDITIONS

Section 1 - Execution, Correlation and Intent of Documents

The contract documents shall be signed in 2 copies by the City and the Contractor.

The contract documents are complementary and what is called for by any one shall be binding. The intention of the documents is to include all labor and materials, equipment and transportation necessary for the proper execution of the work. Materials or work described in words which so applied have a well-known technical or trade meaning have the meaning of those recognized standards.

In case of a conflict among the contract documents listed below in any requirement(s), the requirement(s) of the document listed first shall prevail over any conflicting requirement(s) of a document listed later.

(1) Addenda in reverse chronological order; (2) Detailed Specifications; (3) Standard Specifications; (4) Plans; (5) General Conditions; (6) Contract; (7) Bid Forms; (8) Bond Forms; (9) Bid.

Section 2 - Order of Completion

The Contractor shall submit with each invoice, and at other times reasonably requested by the Supervising Professional, schedules showing the order in which the Contractor proposes to carry on the work. They shall include the dates at which the Contractor will start the several parts of the work, the estimated dates of completion of the several parts, and important milestones within the several parts.

Section 3 - Familiarity with Work

The Bidder or its representative shall make personal investigations of the site of the work and of existing structures and shall determine to its own satisfaction the conditions to be encountered, the nature of the ground, the difficulties involved, and all other factors affecting the work proposed under this Contract. The Bidder to whom this Contract is awarded will not be entitled to any additional compensation unless conditions are clearly different from those which could reasonably have been anticipated by a person making diligent and thorough investigation of the site.

The Bidder shall immediately notify the City upon discovery, and in every case prior to submitting its Bid, of every error or omission in the bidding documents that would be identified by a reasonably competent, diligent Bidder. In no case will a Bidder be allowed the benefit of extra compensation or time to complete the work under this Contract for extra expenses or time spent as a result of the error or omission.

Section 4 - Wage Requirements

Under this Contract, the Contractor shall conform to Chapter 14 of Title I of the Code of the City of Ann Arbor as amended; which in part states "...that all craftsmen, mechanics and laborers employed directly on the site in connection with said improvements, including said employees of subcontractors, shall receive the prevailing wage for the corresponding classes of craftsmen,

mechanics and laborers, as determined by statistics for the Ann Arbor area compiled by the United States Department of Labor. At the request of the City, any contractor or subcontractor shall provide satisfactory proof of compliance with the contract provisions required by the Section."

Where the Contract and the Ann Arbor City Ordinance are silent as to definitions of terms required in determining contract compliance with regard to prevailing wages, the definitions provided in the Davis-Bacon Act as amended (40 U.S.C. 278-a to 276-a-7) for the terms shall be used.

Further, to the extent that any employees of the Contractor providing services under this contract are not part of the class of craftsmen, mechanics and laborers who receive a prevailing wage in conformance with Section 1:320 of Chapter 14 of Title I of the Code of the City of Ann Arbor, the Contractor agrees to conform to Chapter 23 of Title I of the Code of the City of Ann Arbor, as amended, which in part states:

1:814. Applicability.

- (1) This Chapter shall apply to any person that is a contractor/bidder or grantee as defined in Section 1:813 that employs or contracts with five (5) or more individuals; provided, however, that this Chapter shall not apply to a non-profit contractor/bidder or non-profit grantee unless it employs or contracts with ten (10) or more individuals.
- (2) This Chapter shall apply to any grant, contract, or subcontract or other form of financial assistance awarded to or entered into with a contractor/bidder or grantee after the effective date of this Chapter and to the extension or renewal after the effective date of this Chapter of any grant, contract, or subcontract or other form of financial assistance with a contractor/bidder or grantee.

1:815. Living Wages Required.

- (1) Every contractor/bidder or grantee, as defined in Section 1:813, shall pay its covered employees a living wage as established in this Section.
 - (a) For a covered employer that provides employee health care to its employees, the living wage shall be \$12.52 an hour, or the adjusted amount hereafter established under Section 1:815(3).
 - (b) For a covered employer that does not provide health care to its employees, the living wage shall be \$13.96 an hour, or the adjusted amount hereafter established under Section 1:815(3).
- (2) In order to qualify to pay the living wage rate for covered employers providing employee health care under subsection 1:815(1)(a), a covered employer shall furnish proof of said health care coverage and payment therefor to the City Administrator or his/her designee.
- (3) The amount of the living wage established in this Section shall be adjusted upward no later than April 30, 2002, and every year thereafter by a percentage equal to the percentage increase, if any, in the federal poverty guidelines as published by the United States Department of Health and Human Services for the years 2001 and 2002. Subsequent annual adjustments shall be based upon the percentage increase, if any, in the United States Department of Health and Human Services poverty guidelines when comparing the prior calendar year's poverty guidelines to the present calendar year's guidelines. The applicable percentage amount will be converted to an amount in cents by multiplying the existing wage under Section 1.815(1)(b) by said percentage, rounding upward to the next cent, and adding this amount of cents to the existing living wage

levels established under Sections 1:815(1)(a) and 1:815(1)(b). Prior to April 1 of each calendar year, the City will notify any covered employer of this adjustment by posting a written notice in a prominent place in City Hall, and, in the case of a covered employer that has provided an address of record to the City, by a written letter to each such covered employer.

Contractor agrees that all subcontracts entered into by the Contractor shall contain similar wage provision covering subcontractor's employees who perform work on this contract.

Section 5 - Non-Discrimination

The Contractor agrees to comply, and to require its subcontractor(s) to comply, with the nondiscrimination provisions of Section 209 of the Elliot-Larsen Civil Rights Act (MCL 37.2209). The Contractor further agrees to comply with the nondiscrimination provisions of Chapter 112 of the Ann Arbor City Code and to assure that applicants are employed and that employees are treated during employment in a manner which provides equal employment opportunity. The Contractor further agrees to comply with the provisions of Section 9:158 of Chapter 112 of the Ann Arbor City Code and in particular the following excerpts:

9:158. - Nondiscrimination by city contractors.

- (1) All contractors proposing to do business with the City of Ann Arbor shall satisfy the contract compliance administrative policy adopted by the City Administrator in accordance with the guidelines of this section. All city contractors shall ensure that applicants are employed and that employees are treated during employment in a manner which provides equal employment opportunity and tends to eliminate inequality based upon any classification protected by this chapter. All contractors shall agree not to discriminate against an employee or applicant for employment with respect to hire, tenure, terms, conditions, or privileges of employment, or a matter directly or indirectly related to employment, because of any applicable protected classification.
- (2) All contractors shall be required to post a copy of Ann Arbor's Non-Discrimination Ordinance at all work locations where its employees provide services under a contract with the city.
- (3) Upon request, each prospective contractor shall submit to the city data showing current total employment by occupational category, sex and minority group and shall respond to information requests documenting its equal employment opportunity policies and procedures.
- (4) If the contract which is being awarded includes federal requirements for affirmative action, each prospective contractor shall submit to the city data showing current total employment by occupational category, sex and minority group. If, after verifying this data, the City Administrator's designee concludes that it indicates total minority and female employment commensurate with their availability within the contractor's labor recruitment area, i.e., the area from which the contractor can reasonably be expected to recruit, said contractor shall be accepted by the City Administrator's designee as having fulfilled affirmative action requirements for the period of the contract at which time the City Administrator's designee shall conduct another review. If the data demonstrates an under-representation the contractor shall develop an affirmative action program for review by the City Administrator's designee. Said program shall include specific goals and timetables for the hiring and promotion of minorities and females. Said goals shall reflect the availability of minorities and females within the contractor's labor recruitment area. In the case of construction contractors, the City Administrator's designee shall use for employment verification the labor recruitment area of the Ann Arbor metropolitan statistical area. Construction contractors determined to be in compliance shall be accepted by the City Administrator's designee as having fulfilled affirmative action requirements for a period of 1 year at which time the City Administrator's designee shall conduct another review.

- (5) In hiring for construction projects, contractors shall make good faith efforts to employ local persons, so as to enhance the local economy.
- (6) All contracts shall include provisions through which the contractor agrees to follow all applicable federal and state laws.
- (7) The City Administrator's designee shall monitor the compliance of each contractor with the nondiscrimination provisions of each contract. The City Administrator's designee, together with the Human Rights Commission, shall develop procedures and regulations consistent with the administrative policy adopted by the City Administrator for notice and enforcement of non-compliance. Such procedures and regulations shall include a provision for the posting of contractors not in compliance.
- (8) The City Administrator's designee will provide the City's Human Rights Commission with an annual summary report of contracts awarded; affirmative action requirements reviewed, where applicable; any complaints received alleging violation of the contractor's non-discrimination requirements, and actions taken. The Human Rights Commission will be provided, at its request, with additional information related to the report. The Human Rights Commission and the City Administrator's designee will report annually to the City Council on compliance of city contractors with this chapter.
- (9) All city contracts shall provide further that breach of the obligation not to discriminate shall be a material breach of the contract for which the city shall be entitled, at its option, to do any or all of the following:
 - (a) Cancel, terminate, or suspend the contract in whole or part and/or refuse to make any required periodic payments under the contract;
 - (b) Declare the contractor ineligible for the award of any future contracts with the city for a specified length of time;
 - (c) Recover liquidated damages of a specified sum, said sum to be that percentage of the labor expenditure for the time period involved which would have accrued to protected class members had the discrimination provisions not been breached;
 - (d) Impose for each day of non-compliance, liquidated damages of a specified sum, based upon the following schedule:

Contract Amount	Assessed Damages Per Day of Non-Compliance
\$25,000—99,999	\$50.00
100,000—199,999	100.00
200,000—499,999	150.00
500,000—1,499,999	200.00
1,500,000—2,999,999	250.00
3,000,000—4,999,999	300.00
5,000,000 and above	500.00

- (e) In addition the contractor shall be liable for any costs or expenses incurred by the City of Ann Arbor in obtaining from other sources the work and services to be rendered or performed or the goods or properties to be furnished or delivered to the city under this contract.

(Ord. No. 14-25, § 1, 10-20-14)

Section 6 - Materials, Appliances, Employees

Unless otherwise stipulated, the Contractor shall provide and pay for all materials, labor, water, tools, equipment, light, power, transportation, and other facilities necessary or used for the execution and completion of the work. Unless otherwise specified, all materials incorporated in the permanent work shall be new, and both workmanship and materials shall be of the highest quality. The Contractor shall, if required, furnish satisfactory evidence as to the kind and quality of materials.

The Contractor shall at all times enforce strict discipline and good order among its employees, and shall seek to avoid employing on the work any unfit person or anyone not skilled in the work assigned.

Adequate sanitary facilities shall be provided by the Contractor.

Section 7 - Qualifications for Employment

The Contractor shall employ competent laborers and mechanics for the work under this Contract. For work performed under this Contract, employment preference shall be given to qualified local residents.

Section 8 - Royalties and Patents

The Contractor shall pay all royalties and license fees. It shall defend all suits or claims for infringements of any patent rights and shall hold the City harmless from loss on account of infringement except that the City shall be responsible for all infringement loss when a particular process or the product of a particular manufacturer or manufacturers is specified, unless the City has notified the Contractor prior to the signing of the Contract that the particular process or product is patented or is believed to be patented.

Section 9 - Permits and Regulations

The Contractor must secure and pay for all permits, permit or plan review fees and licenses necessary for the prosecution of the work. These include but are not limited to City building permits, right-of-way permits, lane closure permits, right-of-way occupancy permits, and the like. The City shall secure and pay for easements shown on the plans unless otherwise specified.

The Contractor shall give all notices and comply with all laws, ordinances, rules and regulations bearing on the conduct of the work as drawn and specified. If the Contractor observes that the contract documents are at variance with those requirements, it shall promptly notify the Supervising Professional in writing, and any necessary changes shall be adjusted as provided in the Contract for changes in the work.

Section 10 - Protection of the Public and of Work and Property

The Contractor is responsible for the means, methods, sequences, techniques and procedures of construction and safety programs associated with the work contemplated by this contract. The Contractor, its agents or sub-contractors, shall comply with the "General Rules and Regulations for the Construction Industry" as published by the Construction Safety Commission of the State of Michigan and to all other local, State and National laws, ordinances, rules and regulations pertaining to safety of persons and property.

The Contractor shall take all necessary and reasonable precautions to protect the safety of the public. It shall continuously maintain adequate protection of all work from damage, and shall take all necessary and reasonable precautions to adequately protect all public and private

property from injury or loss arising in connection with this Contract. It shall make good any damage, injury or loss to its work and to public and private property resulting from lack of reasonable protective precautions, except as may be due to errors in the contract documents, or caused by agents or employees of the City. The Contractor shall obtain and maintain sufficient insurance to cover damage to any City property at the site by any cause.

In an emergency affecting the safety of life, or the work, or of adjoining property, the Contractor is, without special instructions or authorization from the Supervising Professional, permitted to act at its discretion to prevent the threatened loss or injury. It shall also so act, without appeal, if authorized or instructed by the Supervising Professional.

Any compensation claimed by the Contractor for emergency work shall be determined by agreement or in accordance with the terms of Claims for Extra Cost - Section 15.

Section 11 - Inspection of Work

The City shall provide sufficient competent personnel for the inspection of the work.

The Supervising Professional shall at all times have access to the work whenever it is in preparation or progress, and the Contractor shall provide proper facilities for access and for inspection.

If the specifications, the Supervising Professional's instructions, laws, ordinances, or any public authority require any work to be specially tested or approved, the Contractor shall give the Supervising Professional timely notice of its readiness for inspection, and if the inspection is by an authority other than the Supervising Professional, of the date fixed for the inspection. Inspections by the Supervising Professional shall be made promptly, and where practicable at the source of supply. If any work should be covered up without approval or consent of the Supervising Professional, it must, if required by the Supervising Professional, be uncovered for examination and properly restored at the Contractor's expense.

Re-examination of any work may be ordered by the Supervising Professional, and, if so ordered, the work must be uncovered by the Contractor. If the work is found to be in accordance with the contract documents, the City shall pay the cost of re-examination and replacement. If the work is not in accordance with the contract documents, the Contractor shall pay the cost.

Section 12 - Superintendence

The Contractor shall keep on the work site, during its progress, a competent superintendent and any necessary assistants, all satisfactory to the Supervising Professional. The superintendent will be responsible to perform all on-site project management for the Contractor. The superintendent shall be experienced in the work required for this Contract. The superintendent shall represent the Contractor and all direction given to the superintendent shall be binding as if given to the Contractor. Important directions shall immediately be confirmed in writing to the Contractor. Other directions will be confirmed on written request. The Contractor shall give efficient superintendence to the work, using its best skill and attention.

Section 13 - Changes in the Work

The City may make changes to the quantities of work within the general scope of the Contract at any time by a written order and without notice to the sureties. If the changes add to or deduct from the extent of the work, the Contract Sum shall be adjusted accordingly. All the changes shall be executed under the conditions of the original Contract except that any claim for extension of time caused by the change shall be adjusted at the time of ordering the change.

In giving instructions, the Supervising Professional shall have authority to make minor changes in the work not involving extra cost and not inconsistent with the purposes of the work, but otherwise, except in an emergency endangering life or property, no extra work or change shall be made unless in pursuance of a written order by the Supervising Professional, and no claim for an addition to the Contract Sum shall be valid unless the additional work was ordered in writing.

The Contractor shall proceed with the work as changed and the value of the work shall be determined as provided in Claims for Extra Cost - Section 15.

Section 14 - Extension of Time

Extension of time stipulated in the Contract for completion of the work will be made if and as the Supervising Professional may deem proper under any of the following circumstances:

- (1) When work under an extra work order is added to the work under this Contract;
- (2) When the work is suspended as provided in Section 20;
- (3) When the work of the Contractor is delayed on account of conditions which could not have been foreseen, or which were beyond the control of the Contractor, and which were not the result of its fault or negligence;
- (4) Delays in the progress of the work caused by any act or neglect of the City or of its employees or by other Contractors employed by the City;
- (5) Delay due to an act of Government;
- (6) Delay by the Supervising Professional in the furnishing of plans and necessary information;
- (7) Other cause which in the opinion of the Supervising Professional entitles the Contractor to an extension of time.

The Contractor shall notify the Supervising Professional within 7 days of an occurrence or conditions which, in the Contractor's opinion, entitle it to an extension of time. The notice shall be in writing and submitted in ample time to permit full investigation and evaluation of the Contractor's claim. The Supervising Professional shall acknowledge receipt of the Contractor's notice within 7 days of its receipt. Failure to timely provide the written notice shall constitute a waiver by the Contractor of any claim.

In situations where an extension of time in contract completion is appropriate under this or any other section of the contract, the Contractor understands and agrees that the only available adjustment for events that cause any delays in contract completion shall be extension of the required time for contract completion and that there shall be no adjustments in the money due the Contractor on account of the delay.

Section 15 - Claims for Extra Cost

If the Contractor claims that any instructions by drawings or other media issued after the date of the Contract involved extra cost under this Contract, it shall give the Supervising Professional written notice within 7 days after the receipt of the instructions, and in any event before proceeding to execute the work, except in emergency endangering life or property. The procedure shall then be as provided for Changes in the Work-Section 13. No claim shall be valid unless so made.

If the Supervising Professional orders, in writing, the performance of any work not covered by the contract documents, and for which no item of work is provided in the Contract, and for which no unit price or lump sum basis can be agreed upon, then the extra work shall be done on a Cost-Plus-Percentage basis of payment as follows:

- (1) The Contractor shall be reimbursed for all reasonable costs incurred in doing the work, and shall receive an additional payment of 15% of all the reasonable costs to cover both its indirect overhead costs and profit;
- (2) The term "Cost" shall cover all payroll charges for employees and supervision required under the specific order, together with all worker's compensation, Social Security, pension and retirement allowances and social insurance, or other regular payroll charges on same; the cost of all material and supplies required of either temporary or permanent character; rental of all power-driven equipment at agreed upon rates, together with cost of fuel and supply charges for the equipment; and any costs incurred by the Contractor as a direct result of executing the order, if approved by the Supervising Professional;
- (3) If the extra is performed under subcontract, the subcontractor shall be allowed to compute its charges as described above. The Contractor shall be permitted to add an additional charge of 5% percent to that of the subcontractor for the Contractor's supervision and contractual responsibility;
- (4) The quantities and items of work done each day shall be submitted to the Supervising Professional in a satisfactory form on the succeeding day, and shall be approved by the Supervising Professional and the Contractor or adjusted at once;
- (5) Payments of all charges for work under this Section in any one month shall be made along with normal progress payments. Retainage shall be in accordance with Progress Payments-Section 16.

No additional compensation will be provided for additional equipment, materials, personnel, overtime or special charges required to perform the work within the time requirements of the Contract.

When extra work is required and no suitable price for machinery and equipment can be determined in accordance with this Section, the hourly rate paid shall be 1/40 of the basic weekly rate listed in the Rental Rate Blue Book published by Dataquest Incorporated and applicable to the time period the equipment was first used for the extra work. The hourly rate will be deemed to include all costs of operation such as bucket or blade, fuel, maintenance, "regional factors", insurance, taxes, and the like, but not the costs of the operator.

Section 16 - Progress Payments

The Contractor shall submit each month, or at longer intervals, if it so desires, an invoice covering work performed for which it believes payment, under the Contract terms, is due. The submission shall be to the City's Finance Department - Accounting Division. The Supervising Professional will, within 10 days following submission of the invoice, prepare a certificate for payment for the work in an amount to be determined by the Supervising Professional as fairly representing the acceptable work performed during the period covered by the Contractor's invoice. To insure the proper performance of this Contract, the City will retain a percentage of the estimate in accordance with Act 524, Public Acts of 1980. The City will then, following the receipt of the Supervising Professional's Certificate, make payment to the Contractor as soon as feasible, which is anticipated will be within 15 days.

An allowance may be made in progress payments if substantial quantities of permanent material have been delivered to the site but not incorporated in the completed work if the Contractor, in the opinion of the Supervising Professional, is diligently pursuing the work under this Contract. Such materials shall be properly stored and adequately protected. Allowance in the estimate shall be at the invoice price value of the items. Notwithstanding any payment of any allowance, all risk of loss due to vandalism or any damages to the stored materials remains with the Contractor.

In the case of Contracts which include only the Furnishing and Delivering of Equipment, the payments shall be; 60% of the Contract Sum upon the delivery of all equipment to be furnished, or in the case of delivery of a usable portion of the equipment in advance of the total equipment delivery, 60% of the estimated value of the portion of the equipment may be paid upon its delivery in advance of the time of the remainder of the equipment to be furnished; 30% of the Contract Sum upon completion of erection of all equipment furnished, but not later than 60 days after the date of delivery of all of the equipment to be furnished; and payment of the final 10% on final completion of erection, testing and acceptance of all the equipment to be furnished; but not later than 180 days after the date of delivery of all of the equipment to be furnished, unless testing has been completed and shows the equipment to be unacceptable.

With each invoice for periodic payment, the Contractor shall enclose a Contractor's Declaration - Section 43, and an updated project schedule per Order of Completion - Section 2.

Section 17 - Deductions for Uncorrected Work

If the Supervising Professional decides it is inexpedient to correct work that has been damaged or that was not done in accordance with the Contract, an equitable deduction from the Contract price shall be made.

Section 18 - Correction of Work Before Final Payment

The Contractor shall promptly remove from the premises all materials condemned by the Supervising Professional as failing to meet Contract requirements, whether incorporated in the work or not, and the Contractor shall promptly replace and re-execute the work in accordance with the Contract and without expense to the City and shall bear the expense of making good all work of other contractors destroyed or damaged by the removal or replacement.

If the Contractor does not remove the condemned work and materials within 10 days after written notice, the City may remove them and, if the removed material has value, may store the material at the expense of the Contractor. If the Contractor does not pay the expense of the removal within 10 days thereafter, the City may, upon 10 days written notice, sell the removed materials at auction or private sale and shall pay to the Contractor the net proceeds, after deducting all costs and expenses that should have been borne by the Contractor. If the removed material has no value, the Contractor must pay the City the expenses for disposal within 10 days of invoice for the disposal costs.

The inspection or lack of inspection of any material or work pertaining to this Contract shall not relieve the Contractor of its obligation to fulfill this Contract and defective work shall be made good. Unsuitable materials may be rejected by the Supervising Professional notwithstanding that the work and materials have been previously overlooked by the Supervising Professional and accepted or estimated for payment or paid for. If the work or any part shall be found defective at any time before the final acceptance of the whole work, the Contractor shall forthwith make good the defect in a manner satisfactory to the Supervising Professional. The judgment and the decision of the Supervising Professional as to whether the materials supplied and the work done under this Contract comply with the requirements of the Contract shall be conclusive and final.

Section 19 - Acceptance and Final Payment

Upon receipt of written notice that the work is ready for final inspection and acceptance, the Supervising Professional will promptly make the inspection. When the Supervising Professional finds the work acceptable under the Contract and the Contract fully performed, the Supervising Professional will promptly sign and issue a final certificate stating that the work required by this Contract has been completed and is accepted by the City under the terms and conditions of the Contract. The entire balance found to be due the Contractor, including the retained percentage, shall be paid to the Contractor by the City within 30 days after the date of the final certificate.

Before issuance of final certificates, the Contractor shall file with the City:

- (1) The consent of the surety to payment of the final estimate;
- (2) The Contractor's Affidavit in the form required by Section 44.

In case the Affidavit or consent is not furnished, the City may retain out of any amount due the Contractor, sums sufficient to cover all lienable claims.

The making and acceptance of the final payment shall constitute a waiver of all claims by the City except those arising from:

- (1) unsettled liens;
- (2) faulty work appearing within 12 months after final payment;
- (3) hidden defects in meeting the requirements of the plans and specifications;
- (4) manufacturer's guarantees.

It shall also constitute a waiver of all claims by the Contractor, except those previously made and still unsettled.

Section 20 - Suspension of Work

The City may at any time suspend the work, or any part by giving 5 days notice to the Contractor in writing. The work shall be resumed by the Contractor within 10 days after the date fixed in the written notice from the City to the Contractor to do so. The City shall reimburse the Contractor for expense incurred by the Contractor in connection with the work under this Contract as a result of the suspension.

If the work, or any part, shall be stopped by the notice in writing, and if the City does not give notice in writing to the Contractor to resume work at a date within 90 days of the date fixed in the written notice to suspend, then the Contractor may abandon that portion of the work suspended and will be entitled to the estimates and payments for all work done on the portions abandoned, if any, plus 10% of the value of the work abandoned, to compensate for loss of overhead, plant expense, and anticipated profit.

Section 21 - Delays and the City's Right to Terminate Contract

If the Contractor refuses or fails to prosecute the work, or any separate part of it, with the diligence required to insure completion, ready for operation, within the allowable number of consecutive calendar days specified plus extensions, or fails to complete the work within the

required time, the City may, by written notice to the Contractor, terminate its right to proceed with the work or any part of the work as to which there has been delay. After providing the notice the City may take over the work and prosecute it to completion, by contract or otherwise, and the Contractor and its sureties shall be liable to the City for any excess cost to the City. If the Contractor's right to proceed is terminated, the City may take possession of and utilize in completing the work, any materials, appliances and plant as may be on the site of the work and useful for completing the work. The right of the Contractor to proceed shall not be terminated or the Contractor charged with liquidated damages where an extension of time is granted under Extension of Time - Section 14.

If the Contractor is adjudged a bankrupt, or if it makes a general assignment for the benefit of creditors, or if a receiver is appointed on account of its insolvency, or if it persistently or repeatedly refuses or fails except in cases for which extension of time is provided, to supply enough properly skilled workers or proper materials, or if it fails to make prompt payments to subcontractors or for material or labor, or persistently disregards laws, ordinances or the instructions of the Supervising Professional, or otherwise is guilty of a substantial violation of any provision of the Contract, then the City, upon the certificate of the Supervising Professional that sufficient cause exists to justify such action, may, without prejudice to any other right or remedy and after giving the Contractor 3 days written notice, terminate this Contract. The City may then take possession of the premises and of all materials, tools and appliances thereon and without prejudice to any other remedy it may have, make good the deficiencies or finish the work by whatever method it may deem expedient, and deduct the cost from the payment due the Contractor. The Contractor shall not be entitled to receive any further payment until the work is finished. If the expense of finishing the work, including compensation for additional managerial and administrative services exceeds the unpaid balance of the Contract Sum, the Contractor and its surety are liable to the City for any excess cost incurred. The expense incurred by the City, and the damage incurred through the Contractor's default, shall be certified by the Supervising Professional.

Section 22 - Contractor's Right to Terminate Contract

If the work should be stopped under an order of any court, or other public authority, for a period of 3 months, through no act or fault of the Contractor or of anyone employed by it, then the Contractor may, upon 7 days written notice to the City, terminate this Contract and recover from the City payment for all acceptable work executed plus reasonable profit.

Section 23 - City's Right To Do Work

If the Contractor should neglect to prosecute the work properly or fail to perform any provision of this Contract, the City, 3 days after giving written notice to the Contractor and its surety may, without prejudice to any other remedy the City may have, make good the deficiencies and may deduct the cost from the payment due to the Contractor.

Section 24 - Removal of Equipment and Supplies

In case of termination of this Contract before completion, from any or no cause, the Contractor, if notified to do so by the City, shall promptly remove any part or all of its equipment and supplies from the property of the City, failing which the City shall have the right to remove the equipment and supplies at the expense of the Contractor.

The removed equipment and supplies may be stored by the City and, if all costs of removal and storage are not paid by the Contractor within 10 days of invoicing, the City upon 10 days written notice may sell the equipment and supplies at auction or private sale, and shall pay the Contractor the net proceeds after deducting all costs and expenses that should have been borne by the Contractor and after deducting all amounts claimed due by any lien holder of the equipment or supplies.

Section 25 - Responsibility for Work and Warranties

The Contractor assumes full responsibility for any and all materials and equipment used in the construction of the work and may not make claims against the City for damages to materials and equipment from any cause except negligence or willful act of the City. Until its final acceptance, the Contractor shall be responsible for damage to or destruction of the project (except for any part covered by Partial Completion and Acceptance - Section 26). The Contractor shall make good all work damaged or destroyed before acceptance. All risk of loss remains with the Contractor until final acceptance of the work (Section 19) or partial acceptance (Section 26). The Contractor is advised to investigate obtaining its own builders risk insurance.

The Contractor shall guarantee the quality of the work for a period of one year. The Contractor shall also unconditionally guarantee the quality of all equipment and materials that are furnished and installed under the contract for a period of one year. At the end of one year after the Contractor's receipt of final payment, the complete work, including equipment and materials furnished and installed under the contract, shall be inspected by the Contractor and the Supervising Professional. Any defects shall be corrected by the Contractor at its expense as soon as practicable but in all cases within 60 days. Any defects that are identified prior to the end of one year shall also be inspected by the Contractor and the Supervising Professional and shall be corrected by the Contractor at its expense as soon as practicable but in all cases within 60 days.

The Contractor shall assign all manufacturer or material supplier warranties to the City prior to final payment. The assignment shall not relieve the Contractor of its obligations under this paragraph to correct defects.

Section 26 - Partial Completion and Acceptance

If at any time prior to the issuance of the final certificate referred to in Acceptance and Final Payment - Section 19, any portion of the permanent construction has been satisfactorily completed, and if the Supervising Professional determines that portion of the permanent construction is not required for the operations of the Contractor but is needed by the City, the Supervising Professional shall issue to the Contractor a certificate of partial completion, and immediately the City may take over and use the portion of the permanent construction described in the certificate, and exclude the Contractor from that portion.

The issuance of a certificate of partial completion shall not constitute an extension of the Contractor's time to complete the portion of the permanent construction to which it relates if the Contractor has failed to complete it in accordance with the terms of this Contract. The issuance of the certificate shall not release the Contractor or its sureties from any obligations under this Contract including bonds.

If prior use increases the cost of, or delays the work, the Contractor shall be entitled to extra compensation, or extension of time, or both, as the Supervising Professional may determine.

Section 27 - Payments Withheld Prior to Final Acceptance of Work

The City may withhold or, on account of subsequently discovered evidence, nullify the whole or part of any certificate to the extent reasonably appropriate to protect the City from loss on account of:

- (1) Defective work not remedied;
- (2) Claims filed or reasonable evidence indicating probable filing of claims by other parties

against the Contractor;

- (3) Failure of the Contractor to make payments properly to subcontractors or for material or labor;
- (4) Damage to another Contractor.

When the above grounds are removed or the Contractor provides a Surety Bond satisfactory to the City which will protect the City in the amount withheld, payment shall be made for amounts withheld under this section.

Section 28 - Contractor's Insurance

- (1) The Contractor shall procure and maintain during the life of this Contract, including the guarantee period and during any warranty work, such insurance policies, including those set forth below, as will protect itself and the City from all claims for bodily injuries, death or property damage which may arise under this Contract; whether the acts were made by the Contractor or by any subcontractor or anyone employed by them directly or indirectly. The following insurance policies are required:

- (a) Worker's Compensation Insurance in accordance with all applicable state and federal statutes. Further, Employers Liability Coverage shall be obtained in the following minimum amounts:

Bodily Injury by Accident - \$500,000 each accident
Bodily Injury by Disease - \$500,000 each employee
Bodily Injury by Disease - \$500,000 each policy limit

- (b) Commercial General Liability Insurance equivalent to, as a minimum, Insurance Services Office form CG 00 01 07 98. The City of Ann Arbor shall be named as an additional insured. There shall be no added exclusions or limiting endorsements specifically for the following coverages: Products and Completed Operations, Explosion, Collapse and Underground coverage or Pollution. Further there shall be no added exclusions or limiting endorsements which diminish the City's protections as an additional insured under the policy. The following minimum limits of liability are required:

\$1,000,000 Each occurrence as respect Bodily Injury Liability or Property
Damage Liability, or both combined.
\$2,000,000 Per Job General Aggregate
\$1,000,000 Personal and Advertising Injury
\$2,000,000 Products and Completed Operations Aggregate

- (c) Motor Vehicle Liability Insurance, including Michigan No-Fault Coverages, equivalent to, as a minimum, Insurance Services Office form CA 00 01 07 97. The City of Ann Arbor shall be named as an additional insured. There shall be no added exclusions or limiting endorsements which diminish the City's protections as an additional insured under the policy. Coverage shall include all owned vehicles, all non-owned vehicles and all hired vehicles. Further, the limits of liability shall be \$1,000,000 for each occurrence as respects Bodily Injury Liability or Property Damage Liability, or both combined.

- (d) Umbrella/Excess Liability Insurance shall be provided to apply excess of the Commercial General Liability, Employers Liability and the Motor Vehicle coverage enumerated above, for each occurrence and for aggregate in the amount of \$1,000,000.

- (2) Insurance required under subsection (1)(b) and (1)(c) above shall be considered primary as respects any other valid or collectible insurance that the City may possess, including any self-insured retentions the City may have; and any other insurance the City does possess shall be considered excess insurance only and shall not be required to contribute with this insurance. Further, the Contractor agrees to waive any right of recovery by its insurer against the City.
- (3) In the case of all Contracts involving on-site work, the Contractor shall provide to the City before the commencement of any work under this Contract documentation demonstrating it has obtained the above mentioned policies. Documentation must provide and demonstrate an unconditional 30 day written notice of cancellation in favor of the City of Ann Arbor. Further, the documentation must explicitly state the following: (a) the policy number; name of insurance company; name and address of the agent or authorized representative; name and address of insured; project name; policy expiration date; and specific coverage amounts; (b) any deductibles or self-insured retentions which shall be approved by the City, in its sole discretion; (c) that the policy conforms to the requirements specified. An original certificate of insurance may be provided as an initial indication of the required insurance, provided that no later than 21 calendar days after commencement of any work the Contractor supplies a copy of the endorsements required on the policies. Upon request, the Contractor shall provide within 30 days a copy of the policy(ies) to the City. If any of the above coverages expire by their terms during the term of this Contract, the Contractor shall deliver proof of renewal and/or new policies to the Administering Service Area/Unit at least ten days prior to the expiration date.
- (4) Any Insurance provider of Contractor shall be admitted and authorized to do business in the State of Michigan and shall carry and maintain a minimum rating assigned by A.M. Best & Company's Key Rating Guide of "A-" Overall and a minimum Financial Size Category of "V". Insurance policies and certificates issued by non-admitted insurance companies are not acceptable unless approved in writing by the City.

Section 29 - Surety Bonds

Bonds will be required from the successful bidder as follows:

- (1) A Performance Bond to the City of Ann Arbor for the amount of the bid(s) accepted;
- (2) A Labor and Material Bond to the City of Ann Arbor for the amount of the bid(s) accepted.

Bonds shall be executed on forms supplied by the City in a manner and by a Surety Company authorized to transact business in Michigan and satisfactory to the City Attorney.

Section 30 - Damage Claims

The Contractor shall be held responsible for all damages to property of the City or others, caused by or resulting from the negligence of the Contractor, its employees, or agents during the progress of or connected with the prosecution of the work, whether within the limits of the work or elsewhere. The Contractor must restore all property injured including sidewalks, curbing, sodding, pipes, conduit, sewers or other public or private property to not less than its original condition with new work.

Section 31 - Refusal to Obey Instructions

If the Contractor refuses to obey the instructions of the Supervising Professional, the Supervising Professional shall withdraw inspection from the work, and no payments will be made for work performed thereafter nor may work be performed thereafter until the Supervising Professional shall have again authorized the work to proceed.

Section 32 - Assignment

Neither party to the Contract shall assign the Contract without the written consent of the other. The Contractor may assign any monies due to it to a third party acceptable to the City.

Section 33 - Rights of Various Interests

Whenever work being done by the City's forces or by other contractors is contiguous to work covered by this Contract, the respective rights of the various interests involved shall be established by the Supervising Professional, to secure the completion of the various portions of the work in general harmony.

The Contractor is responsible to coordinate all aspects of the work, including coordination of, and with, utility companies and other contractors whose work impacts this project.

Section 34 - Subcontracts

The Contractor shall not award any work to any subcontractor without prior written approval of the City. The approval will not be given until the Contractor submits to the City a written statement concerning the proposed award to the subcontractor. The statement shall contain all information the City may require.

The Contractor shall be as fully responsible to the City for the acts and omissions of its subcontractors, and of persons either directly or indirectly employed by them, as it is for the acts and omissions of persons directly employed by it.

The Contractor shall cause appropriate provisions to be inserted in all subcontracts relative to the work to bind subcontractors to the Contractor by the terms of the General Conditions and all other contract documents applicable to the work of the subcontractors and to give the Contractor the same power to terminate any subcontract that the City may exercise over the Contractor under any provision of the contract documents.

Nothing contained in the contract documents shall create any contractual relation between any subcontractor and the City.

Section 35 - Supervising Professional's Status

The Supervising Professional has the right to inspect any or all work. The Supervising Professional has authority to stop the work whenever stoppage may be appropriate to insure the proper execution of the Contract. The Supervising Professional has the authority to reject all work and materials which do not conform to the Contract and to decide questions which arise in the execution of the work.

The Supervising Professional shall make all measurements and determinations of quantities. Those measurements and determinations are final and conclusive between the parties.

Section 36 - Supervising Professional's Decisions

The Supervising Professional shall, within a reasonable time after their presentation to the Supervising Professional, make decisions in writing on all claims of the City or the Contractor and on all other matters relating to the execution and progress of the work or the interpretation of the contract documents.

Section 37 - Storing Materials and Supplies

Materials and supplies may be stored at the site of the work at locations agreeable to the City unless specific exception is listed elsewhere in these documents. Ample way for foot traffic and drainage must be provided, and gutters must, at all times, be kept free from obstruction. Traffic on streets shall be interfered with as little as possible. The Contractor may not enter or occupy with agents, employees, tools, or material any private property without first obtaining written permission from its owner. A copy of the permission shall be furnished to the Supervising Professional.

Section 38 - Lands for Work

The Contractor shall provide, at its own expense and without liability to the City, any additional land and access that may be required for temporary construction facilities or for storage of materials.

Section 39 - Cleaning Up

The Contractor shall, as directed by the Supervising Professional, remove at its own expense from the City's property and from all public and private property all temporary structures, rubbish and waste materials resulting from its operations unless otherwise specifically approved, in writing, by the Supervising Professional.

Section 40 - Salvage

The Supervising Professional may designate for salvage any materials from existing structures or underground services. Materials so designated remain City property and shall be transported or stored at a location as the Supervising Professional may direct.

Section 41 - Night, Saturday or Sunday Work

No night or Sunday work (without prior written City approval) will be permitted except in the case of an emergency and then only to the extent absolutely necessary. The City may allow night work which, in the opinion of the Supervising Professional, can be satisfactorily performed at night. Night work is any work between 8:00 p.m. and 7:00 a.m. No Saturday work will be permitted unless the Contractor gives the Supervising Professional at least 48 hours but not more than 5 days notice of the Contractor's intention to work the upcoming Saturday.

Section 42 - Sales Taxes

Under State law the City is exempt from the assessment of State Sales Tax on its direct purchases. Contractors who acquire materials, equipment, supplies, etc. for incorporation in City projects are not likewise exempt. State Law shall prevail. The Bidder shall familiarize itself with the State Law and prepare its Bid accordingly. No extra payment will be allowed under this Contract for failure of the Contractor to make proper allowance in this bid for taxes it must pay.

Section 43

CONTRACTOR'S DECLARATION

I hereby declare that I have not, during the period _____, 20____, to _____, 20____, performed any work, furnished any materials, sustained any loss, damage or delay, or otherwise done anything in addition to the regular items (or executed change orders) set forth in the Contract titled _____, for which I shall ask, demand, sue for, or claim compensation or extension of time from the City, except as I hereby make claim for additional compensation or extension of time as set forth on the attached itemized statement. I further declare that I have paid all payroll obligations related to this Contract that have become due during the above period and that all invoices related to this Contract received more than 30 days prior to this declaration have been paid in full except as listed below.

There is/is not (Contractor please circle one and strike one as appropriate) an itemized statement attached regarding a request for additional compensation or extension of time.

Contractor

Date

By _____
(Signature)

Its _____
(Title of Office)

Past due invoices, if any, are listed below.

Section 44

CONTRACTOR'S AFFIDAVIT

The undersigned Contractor, _____, represents that on _____, 20____, it was awarded a contract by the City of Ann Arbor, Michigan to _____ under the terms and conditions of a Contract titled _____. The Contractor represents that all work has now been accomplished and the Contract is complete.

The Contractor warrants and certifies that all of its indebtedness arising by reason of the Contract has been fully paid or satisfactorily secured; and that all claims from subcontractors and others for labor and material used in accomplishing the project, as well as all other claims arising from the performance of the Contract, have been fully paid or satisfactorily settled. The Contractor agrees that, if any claim should hereafter arise, it shall assume responsibility for it immediately upon request to do so by the City of Ann Arbor.

The Contractor, for valuable consideration received, does further waive, release and relinquish any and all claims or right of lien which the Contractor now has or may acquire upon the subject premises for labor and material used in the project owned by the City of Ann Arbor.

This affidavit is freely and voluntarily given with full knowledge of the facts.

Contractor

Date

By _____
(Signature)

Its _____
(Title of Office)

Subscribed and sworn to before me, on this _____ day of _____, 20____
_____, _____ County, Michigan

Notary Public
_____ County, MI

My commission expires on:

STANDARD SPECIFICATIONS

All work under this contract shall be performed in accordance with the Public Services Department Standard Specifications in effect at the date of availability of the contract documents stipulated in the Bid. All work under this Contract which is not included in these Standard Specifications, or which is performed using modifications to these Standard Specifications, shall be performed in accordance with the Detailed Specifications included in these contract documents.

A copy of the Public Services Department Standard Specifications may be purchased from the Engineering Division, (Fourth Floor, City Hall, Ann Arbor, Michigan), for \$35.00 per copy. In addition, a copy of these Standard Specifications is available for public viewing at the Engineering Division office, for review Monday through Friday between the hours of 8:30 a.m. and 4:00 p.m.

Copies of the Standard Specifications can also be downloaded from the web link:

http://www.a2gov.org/government/publicservices/project_management/privatedev/pages/standardspecificationsbook.aspx.

**DETAILED SPECIFICATION
FOR
PROJECT SCHEDULE**

AA:JN

1 of 2

2/5/16

Examination of Plans, Specifications, and Work Site: Bidders shall carefully examine the Bid Form, plans, specifications and the work site until the Bidder is satisfied as to all local conditions affecting the contract and the detailed requirements of construction. The submission of the bid shall be considered prima facie evidence that the Bidder has made such examination and is satisfied as to the conditions to be encountered in performing the work and all requirements of the contract.

The entire work under this Contract shall be completed in accordance with, and subject to, the scheduling requirements as outlined below, and all other requirements of the Contract Documents.

By no later than **the Pre-Construction Meeting** the Contractor shall submit a detailed schedule of work, by major item of work, for the Engineer's review and approval. The proposed schedule must fully comply with the scheduling requirements contained in this Detailed Specification. The Contractor shall update the approved work schedule each week and present it to the Engineer at the weekly progress meeting.

The Contractor will receive two (2) copies of the Contract, for his/her execution, on or before **March 11, 2016**. The Contractor shall properly execute both copies of the Contract and return them, with the required Bonds and Insurance Certificate, to the City **no later than April 11, 2016**.

Contractor may begin construction only after receiving the copy of executed contract documents and the Notice to Proceed from the City. Please allow two (2) weeks for these. Appropriate time extensions shall be granted if the Notice to Proceed is delayed due to the circumstances controlled by the City.

All contract work must be complete and open to traffic by **April 15, 2016**. Project completion includes, but not limited to, paving thru the top course of both Stages, the restoration of all disturbed areas, placement of permanent pavement markings, and the removal of any and all traffic control devices. Failure to complete all work as specified herein within the times specified herein, including time extensions granted thereto as determined by the Engineer, shall entitle the City to deduct from the payments due the Contractor, **\$1000.00** in "Liquidated Damages", and not as a penalty, for each and every calendar day beyond the completion date.

The week of April 17, 2016 is the Ann Arbor Street Art Fair. The Organizers are permitted to close area streets, including Liberty Street, and begin set up July 20, 2016 at 6:00 a.m., and open to all streets to traffic by 6:00 a.m. on July 25, 2016. If the City determines the Contractors progress is not sufficient to meet the Project Completion date as defined above, the City may suspend operations and direct the Contractor to prepare to open the project site to pedestrian and vehicular traffic. Any costs encumbered by the Contractor to accomplish this will be at his/her expense. Upon suspending operations, the City will begin assessing Liquidated Damages, which will include the dates note above as permitted by the City to the Art Fair Organizers for the Art Fair, until the project is complete.

The Contractor may propose to adjust the limits or sequencing of construction in order to complete the work more efficiently. Changes to the recommended construction sequence must

be approved in writing by the Engineer prior to construction and must assure all required coordination with other projects and time lines.

Time is of the essence in the performance of the work of this contract. The Contractor is expected to mobilize sufficient personnel and equipment, and work throughout all authorized hours in order to complete the project by the final completion date. Costs for the Contractor to organize, coordinate, and schedule all of the work of the project, will not be paid for separately, but shall be included in the bid price of the Contract Item "General Conditions."

CITY OF ANN ARBOR
DETAILED SPECIFICATION
FOR
MAINTAINING TRAFFIC

AA:JN

1 of 6

2/4/16

a. Description. Traffic shall be maintained by the Contractor throughout the project duration in accordance with the City of Ann Arbor Standard Specifications, subsection 104.11 and section 812 of the Michigan Department of Transportation (MDOT) 2012 Standard Specifications for Construction, the Michigan Manual of Uniform Traffic Control Devices (MMUTCD), applicable supplemental specifications, as directed by the Engineer, and as herein specified.

The following, and herein included, Michigan Department of Transportation (MDOT) Maintaining Traffic Typical and Work Zone Device Details apply to the project: m0020a, m0040a, m0110a, m0140a, WZD-100-A, and WZD-125-E.

These maintaining traffic provisions are subject to change in the event of special community activities.

The permanent pavement marking items are included in the contract and shall be placed per the MDOT 2012 Standard Specifications for Construction prior to the removal of any devices required to temporarily maintain traffic during construction, and also prior to opening the project to traffic.

b. Materials. Materials for all devices used to temporarily control and maintain traffic shall meet the requirements of section 812 of the MDOT 2012 Standard Specifications for Construction, the MMUTCD, and the applicable MDOT typicals and details included herein.

All signs shall be 48 inches by 48 inches, unless otherwise noted. Temporary signs, which are to remain in the same place for 14 days or more, shall be installed on driven posts. All other temporary signs may be installed on portable supports. All signs shall have a minimum bottom height of 7.0 feet.

Channelizing devices required for all lane closures shall be plastic drums.

c. Construction. Construction methods shall meet the requirements of section 812 of the MDOT 2012 Standard Specifications for Construction.

The Contractor shall furnish and place all necessary temporary traffic control devices to maintain traffic during construction. All work, construction equipment, and material storage shall be kept behind the curb, or behind barricades or channelizing devices, all in combination with protective fencing, if required to protect open excavations, and shall not in any way hamper vehicle movement or impair traffic vision. The contractor shall also provide protection to all uncured concrete sidewalk, driveways, and curb and gutter as may be needed until all traffic, either foot or otherwise, can cross without damage. Additional barricades and protective fencing shall be installed at the end of each day to insure no disturbance to the work area.

Distances between warning, regulatory, and guide signs as shown on the typicals and details are approximate, and may require field adjustment, as directed by the Engineer.

The Contractor shall maintain two-way traffic on major streets, access for local traffic on local streets, and keep all intersections open to traffic at all times, unless specifically authorized in writing by the Engineer.

The Contractor shall maintain traffic such that no vehicle shall be required to drive into active work areas. Patch areas which extend more than halfway across the roadway shall be removed and replaced so as to provide a minimum of half the pavement width at all times for maintaining traffic.

All temporary traffic/pedestrian control devices furnished by the Contractor shall remain the property of the Contractor. The City shall not be responsible for stolen or damaged signs, barricades, plastic drums and other traffic maintenance items. The Contractor shall replace missing and/or damaged traffic control devices immediately, at no additional cost to the City.

1. Construction Influence Area (CIA). The CIA shall include the area within the width of the right-of-way of the following roads, within the approximate limits described below:

- South Division Street – approximately 250 feet north of Packard to East Huron Street

In addition, the CIA includes the right-of-way for a distance before and after the limits of construction as outlined above, the detour route, and the right-of-way of any intersecting road adjacent to the work zone as far as the construction or detour signing extends.

The Contractor shall furnish, erect, maintain, and upon completion of the work, remove all traffic control devices within and around the CIA for the safety and protection of traffic. This includes, but is not limited to, regulatory and warning signs, barricades, channeling devices and other minor devices where required by the Engineer.

The Contractor shall coordinate its operations with all subcontractors, utilities, and/or other contractors performing work on this and other projects within, or adjacent to, the Construction Influence Area (CIA). The contractor shall avoid conflicts in maintaining traffic operations, signing, and orderly progress of other contract work.

2. Permits. Prior to the start of construction, the Contractor shall obtain a "Right-of-Way" Permit from City of Ann Arbor Customer Services Unit. The Contractor shall notify the Project Engineer and obtain a "Traffic Detour or Lane Closure" Permit from City of Ann Arbor Project Management Services Unit a minimum of 72 business hours prior to the implementation of any traffic shifts, lane closures and street closures. A permit has been issued from MDOT for the lane closure in East Huron Street. The contractor will have to provide insurance in accordance with the permit. The fees for these permits will be waived.

3. Work Times and Restrictions. All work shall be conducted Monday through Saturday between 7:00am and 8:00pm; unless an alternate plan identifying the days and hours of work has been authorized by the City prior to commencement of construction. Should night work be required for any reason, the Project Engineer must be notified three (3) working days (72 hours) in advance of such work, and the work must have the approval of the City prior to commencement.

Only work of an emergency nature or work required to insure traffic safety shall be performed on Sunday and only with prior approval by the City.

No road work shall be performed nor traffic interruptions be permitted on Sundays, and during the Memorial Day and July 4th holiday periods. All streets and sidewalks that can be opened shall be opened. Trucking on or off site will not be permitted.

During non-working periods, any area with uncompleted work shall have plastic drums at specific locations and protective fencing, as directed by the Engineer.

4. **Traffic Restrictions.** The Contractor shall, at all times, conduct its work to insure the least possible obstruction to traffic and inconvenience to the general public, businesses, and residents in the vicinity of the work.

All major changes in traffic control shall be made either between 9:00 a.m. and 3:30 p.m. or between 7:00 p.m. and 6:30 a.m. in order to minimize interference with rush hour traffic. All traffic controls must be in place and ready for traffic each day by 6:30 a.m. and 3:30 p.m. Temporary obstruction of traffic for loading and unloading of trucks will be permitted if the Contractor provides traffic regulators (flag persons) in conformance with Part VI of the MMUTCD. During temporary obstructions, a minimum of two traffic regulators are required. The cost of traffic regulators (flag control) shall be included in the contract pay item "Minor Traffic Control, Modified, Max \$_".

Access to businesses, residences, and side street(s) within the CIA shall be maintained for the duration of the project. The Contractor shall make every effort to coordinate its operations to minimize interruptions impacting this access. The Contractor shall notify the Project Engineer forty-eight (48) hours in advance of any work to be performed on or near business or residential driveways, and stage work so that it is part-width when it is necessary to work in these areas. Prohibiting access to businesses and residences will not be allowed during any phase of construction, and flagging will be required at the discretion of the Engineer.

A minimum of one lane of traffic must be maintained on Division Street, Liberty Street and East Washington at all times by use of signage and other traffic control devices unless other authorized by the Engineer.

Lane width shall be a minimum of 10 feet wide. Contractor shall schedule work so that under no circumstances traffic is stopped. The work within the CIA shall be suspended, during peak traffic hours and/or when traffic is being unduly hampered or delayed by all construction activity, at the discretion of the Engineer.

5. **Emergency Services.** The Contractor shall notify local police, fire departments and emergency response units a minimum of three business days (72 hours) prior to the closure of any lanes, or traffic shifts causing restricted movements of traffic or restricted access. Fire hydrants in or adjacent to the work shall be kept "live" and fire fighting forces made aware of their availability at all times during construction.

d. Project Phasing. The Contractor shall notify the Engineer a minimum of 72 hours prior to the implementation of lane or road closures. See Staging Plan for details and limits of construction.

- **Stage 1 Phase 1** The work zone is limited to the east half of South Division Street from the POB to the north quadrant of East William Street. The Jefferson Street will be closed upon commencement of water main or bumpout construction.

East William may not be closed until construction operations are set to begin in the northeast quadrant. Once operations begin, they must be concurrent and consecutive until complete thru the placement of hand patching to restore pedestrian traffic. When complete, immediately move operations to the southeast quadrant and complete construction thru placement of hand patching to restore both pedestrian and vehicular traffic. Open East William immediately and cover all associated detour and road closure signs.

Jefferson Street may remain closed for the duration of the project.

- **Stage 1 Phase 2** The work zone is extended to include the east half of South Division Street to the south quadrant of East Liberty Street. Two way traffic must be maintained on East Liberty until construction commences in the southeast quadrant. Traffic will then be restricted to one lane in the westbound direction for the remainder of the project.

- **Stage 1 Phase 2A and 3** The work zone is extended to include the east half of South Division Street to the south edge of East Huron Street. Two way traffic must be maintained on East Washington until construction commences in the southeast quadrant. Traffic will then be restricted to one lane in the eastbound direction for the remainder of the project.

The south lane of East Huron Street may not be closed until cold milling operations are set to begin. Upon placing the top course, open East Huron Street.

- **Stage 2 Phase 1** The work zone is limited to the west half of South Division Street from the POB to the north quadrant of East William Street. The Jefferson Street will be closed upon commencement of water main or bumpout construction.

Construction in the William Street intersection may not begin until the 4 inch water main has been abandoned in this intersection. East William may not be closed until construction operations are set to begin in the northwest quadrant. Once operations begin, they must be concurrent and consecutive until complete thru the placement of hand patching to restore pedestrian traffic. When complete, immediately move operations to the southwest quadrant and complete construction thru placement of hand patching to restore both pedestrian and vehicular traffic. Open East William immediately and cover all associated detour and road closure signs.

Jefferson Street may remain closed for the duration of the project.

- **Stage 1 Phase 2** The work zone is extended to include the west half of South Division Street to the south quadrant of East Liberty Street. Traffic restrictions from Stage 1 maintaining one lane in the westbound direction are still in effect.

- **Stage 1 Phase 2A and 3** The work zone is extended to include the west half of South Division Street to the south edge of East Huron Street. Traffic restrictions from Stage 1 maintaining one lane in the eastbound direction are still in effect.

The south lane of East Huron Street may not be closed until cold milling operations are set to begin. Upon placing the top course, open East Huron Street.

e. Traffic Control Devices. All signs, barricades, warning lights, and other traffic control devices shall be in accordance with the 2011 Michigan Manual of Uniform Traffic Control Devices (MMUTCD). Signing for lane closures shall be in accordance with MDOT maintaining traffic typical plans M0020a, M0040a, M0110a, M0150a and the maintaining traffic sheets in the plans.

Also, when work is in the proximity of a cross street, signing according to the MMUTCD shall be placed on the cross street.

The Contractor shall place all Sign, Type B, Temp, Prismatic with locations shown on the maintaining traffic sheets in the plans and maintaining traffic typical detail WZD-100-A on driven supports only (posts driven in ground) to prevent movement. Signs on driven supports shall be covered as called out in the plans while the detour route is in place.

Distances shown between construction warning, regulatory and guide signs shown on the plans are approximate and may require field adjustment, as directed by the Engineer.

Portable Changeable Message Signs (PCMS) - Contact the Engineer for the initial message to be displayed upon delivering the PCMS to their appropriate location. PCMS may not be in place without a message.

Each PCMS shall be delineated with three (3) lighted high intensity plastic drums. The drums shall be placed on the shoulder at an offset and alignment as directed by the Engineer. Displaying different messages will be expected through the life of the project. All messages shall have the approval of the Engineer prior to displaying the message. **All PCMS shall have the ability to change/update the message from a remote location.** PCMS shall be turned off and removed from the roadway and outside of the clear zone when not being used to display a message approved by the Engineer. Turning the sign parallel to traffic, or turning off the PCMS and leaving in place is not acceptable.

Traffic regulators will be required each day construction operations and equipment occupy any portion of a travel lane. The contractor is advised that due to the narrow shoulders within the construction zone, traffic regulators shall be provided every day, including for restoration activities.

All traffic regulators must be properly trained and verification of training may be required.

A minimum of two traffic regulators will be required. They are to be assigned only to traffic control; they may not be members of the crew performing other duties.

Traffic regulators are required to wear high-visibility clothing, be equipped with a two-way radio system, and must have stop/slow paddles in accordance with the MMUTCD.

f. Measurement and Payment. The completed work for maintaining traffic, as described, will be paid for at the contract unit prices for the following items in accordance with subsection 812.04 of the Standard Specifications for Construction.

<u>Pay Item</u>	<u>Pay Unit</u>
Barricade, Type III, High Intensity, Double Sided, Furn	Each
Barricade, Type III, High Intensity, Double Sided, Oper	Each
Lighted Arrow, Type C, Furn.....	Each
Lighted Arrow, Type C, Oper	Each
Plastic Drum, High Intensity, Furn	Each
Plastic Drum, High Intensity, Oper	Each
Sign, Portable, Changeable Message, Furn	Each
Sign, Portable, Changeable Message, Oper.....	Each
Sign, Type B, Temp, Prismatic, Furn	Square Foot
Sign, Type B, Temp, Prismatic, Oper	Square Foot
Sign, Type B, Temp, Prismatic, Special, Furn.....	Square Foot
Sign, Type B, Temp, Prismatic, Special, Oper	Square Foot
Sign Cover	Each
Traffic Regulator Control	Lump Sum
Minor Traffic Control, Modified, Max \$ _	Lump Sum

The estimated quantities for maintaining traffic are based on the signing and related traffic control devices deemed necessary for this project as shown on the applicable MDOT Maintaining Traffic Typical, and include traffic regulators, lighted arrows and minor traffic devices.

Payment for traffic control devices shall be based on the maximum quantity in place at any one time during the project, as determined by the Engineer. Non-standard specially fabricated signs, other than those used to determine the maximum square feet of signage, will be paid for separately by the unit square foot for each sign furnished and operated during construction.

Any additional signing or maintaining traffic devices required to expedite the construction shall be at the Contractor's expense.

Temporary traffic control devices will be paid for only once irrespective of the number of times moved. Traffic control devices not paid for separately shall be included in the payment for the pay item "Minor Traffic Control, Modified, Max \$ _".

MINIMUM MERGING TAPER LENGTH "L" (FEET)

OFFSET FEET	POSTED SPEED LIMIT, MPH (PRIOR TO WORK AREA)									
	25	30	35	40	45	50	55	60	65	70
1	10	15	20	27	45	50	55	60	65	70
2	21	30	41	53	90	100	110	120	130	140
3	31	45	61	80	135	150	165	180	195	210
4	42	60	82	107	180	200	220	240	260	280
5	52	75	102	133	225	250	275	300	325	350
6	63	90	123	160	270	300	330	360	390	420
7	73	105	143	187	315	350	385	420	455	490
8	83	120	163	213	360	400	440	480	520	560
9	94	135	184	240	405	450	495	540	585	630
10	104	150	204	267	450	500	550	600	650	700
11	115	165	225	293	495	550	605	660	715	770
12	125	180	245	320	540	600	660	720	780	840
13	135	195	266	347	585	650	715	780	845	910
14	146	210	286	374	630	700	770	840	910	980
15	157	225	307	400	675	750	825	900	975	1050

TAPER LENGTH "L" IN FEET

THE FORMULAS FOR THE MINIMUM LENGTH OF A MERGING TAPER IN DERIVING THE "L" VALUES SHOWN IN THE ABOVE TABLES ARE AS FOLLOWS:

"L" = $\frac{W \times S^2}{60}$ WHERE POSTED SPEED PRIOR TO THE WORK AREA IS 40 MPH OR LESS

"L" = S x W WHERE POSTED SPEED PRIOR TO THE WORK AREA IS 45 MPH OR GREATER

- L = MINIMUM LENGTH OF MERGING TAPER
- S = POSTED SPEED LIMIT IN MPH PRIOR TO WORK AREA
- W = WIDTH OF OFFSET

TYPES OF TAPERS

UPSTREAM TAPERS

- MERGING TAPER
- SHIFTING TAPER
- SHOULDER TAPER
- TWO-WAY TRAFFIC TAPER

DOWNSTREAM TAPERS

(USE IS OPTIONAL)

TAPER LENGTH

- L - MINIMUM
- 1/2 L - MINIMUM
- 1/3 L - MINIMUM
- 100' - MAXIMUM
- 100' - MINIMUM (PER LANE)

 TRAFFIC AND SAFETY MAINTAINING TRAFFIC TYPICAL	TABLES FOR "L", "D" AND "B" VALUES		
	DRAWN BY: CON:AE:djf	JUNE 2006	SHEET
CHECKED BY: BMM	PLAN DATE:	M0020a	1 OF 2
FILE: K:/DGN/TSR/STDS/ENGLISH/MNTTRF/M0020a.dgn		REV.	08/21/2006

DISTANCE BETWEEN TRAFFIC CONTROL DEVICES "D"
AND LENGTH OF LONGITUDINAL BUFFER SPACE ON
"WHERE WORKERS PRESENT" SEQUENCES

"D" DISTANCES	POSTED SPEED LIMIT, MPH (PRIOR TO WORK AREA)									
	25	30	35	40	45	50	55	60	65	70
D (FEET)	250	300	350	400	450	500	550	600	650	700

GUIDELINES FOR LENGTH OF
LONGITUDINAL BUFFER SPACE "B"

SPEED* MPH	LENGTH FEET
20	33
25	50
30	83
35	132
40	181
45	230
50	279
55	329
60	411
65	476
70	542

* POSTED SPEED, OFF PEAK 85TH PERCENTILE SPEED PRIOR TO WORK STARTING, OR THE ANTICIPATED OPERATING SPEED

1 BASED UPON AMERICAN ASSOCIATION OF STATE HIGHWAY AND TRANSPORTATION OFFICIALS (AASHTO) BRAKING DISTANCE PORTION OF STOPPING SIGHT DISTANCE FOR WET AND LEVEL PAVEMENTS (A POLICY ON GEOMETRIC DESIGN OF HIGHWAY AND STREETS), AASHTO. THIS AASHTO DOCUMENT ALSO RECOMMENDS ADJUSTMENTS FOR THE EFFECT OF GRADE ON STOPPING AND VARIATION FOR TRUCKS.

 Michigan Department of Transportation TRAFFIC AND SAFETY MAINTAINING TRAFFIC TYPICAL	TABLES FOR "L", "D" AND "B" VALUES		
	DRAWN BY: CON:AE:djf CHECKED BY: BMM	JUNE 2006 PLAN DATE:	M0020a
FILE: K:/DGN/TSR/STDS/ENGLISH/MNTTRF/M0020a.dgn REV. 08/21/2006			





PLACE THROUGHOUT WORK AREA AS INDICATED AND AFTER ALL MAJOR CROSSROADS IF PERMANENT SIGNS ARE NOT IN PLACE.

PLACE THIS SIGN ALONG WITH THE ADVANCE WORK ZONE SIGNING AS DEPICTED ON THE APPROPRIATE TYPICAL M0030a-M0080a.

PLACE THROUGHOUT WORK AREA AS INDICATED AND AFTER ALL MAJOR CROSSROADS IF PERMANENT SIGNS ARE NOT IN PLACE.

PLACE THIS SIGN ALONG WITH THE ADVANCE WORK ZONE SIGNING AS DEPICTED ON THE APPROPRIATE TYPICAL M0030a-M0080a.

KEY

-  TRAFFIC REGULATOR
-  CHANNELIZING DEVICES
-  LIGHTED ARROW PANEL (CAUTION MODE)
-  TRAFFIC FLOW
-  REFLECTS EXISTING SPEED LIMIT

SIGN = 200 ft ± 2 - TYPE B PLUS ADDITIONAL R2-1's THROUGHOUT WORK AREA

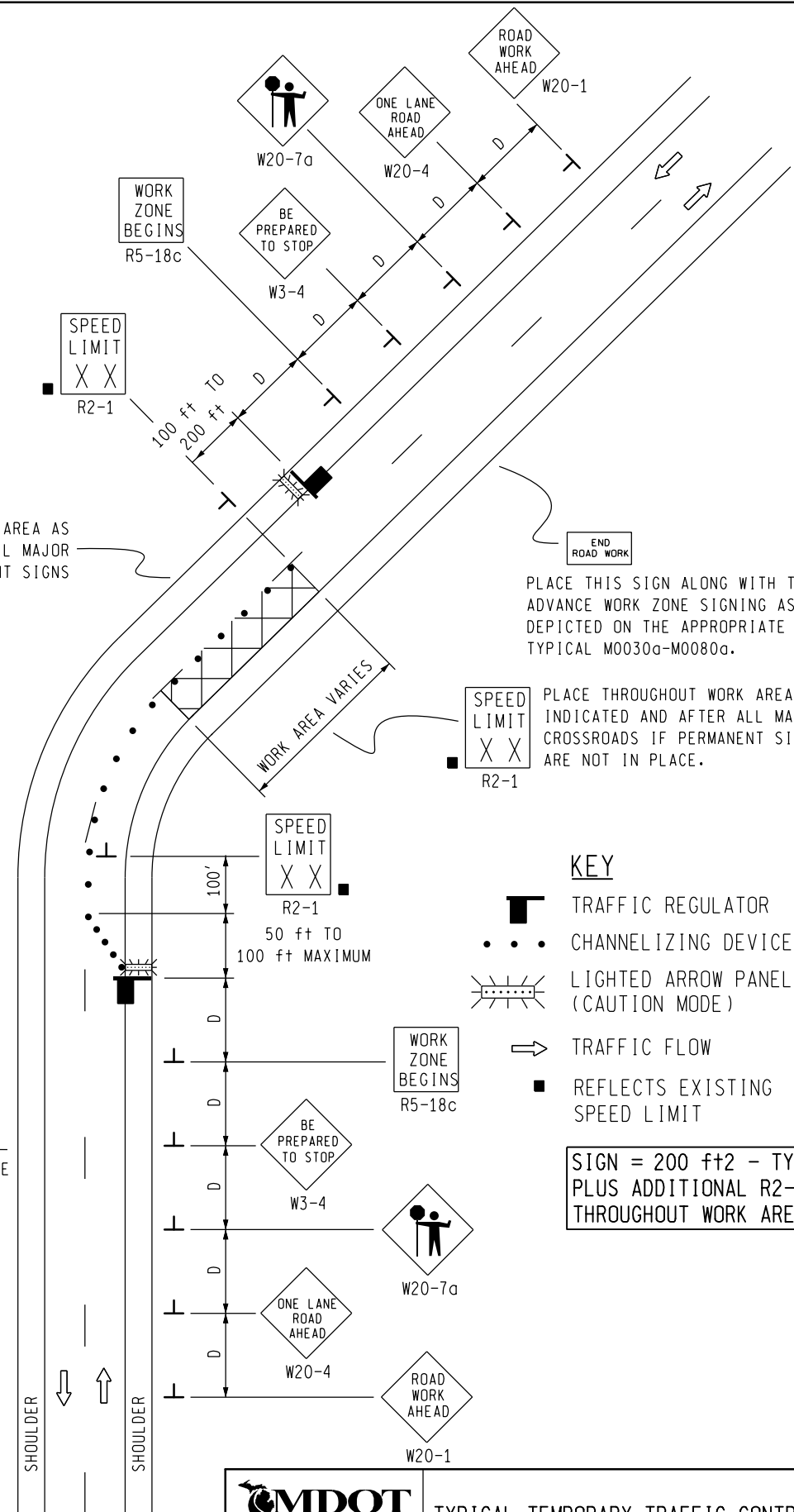

NOT TO SCALE

 Michigan Department of Transportation TRAFFIC AND SAFETY MAINTAINING TRAFFIC TYPICAL		TYPICAL TEMPORARY TRAFFIC CONTROL FOR A TWO-LANE TWO-WAY ROADWAY WHERE ONE LANE IS CLOSED UTILIZING TRAFFIC REGULATORS, NO SPEED REDUCTION	
DRAWN BY: CON:AE:djf CHECKED BY: BMM:CRB	OCTOBER 2011 PLAN DATE:	M0140a	SHEET 1 OF 2
FILE: PW RD/TS/Typicals/Signs/MT NON FWY/M0140a.dgn REV. 10/04/2011			

NOTES

- 1H. D = DISTANCE BETWEEN TRAFFIC CONTROL DEVICES AND LENGTH OF LONGITUDINAL BUFFERS
SEE **M0020a** FOR "D" VALUES.
2. ALL NON-APPLICABLE SIGNING WITHIN THE CIA SHALL BE MODIFIED TO FIT CONDITIONS, COVERED OR REMOVED.
3. DISTANCES BETWEEN SIGNS, THE VALUES FOR WHICH ARE SHOWN IN TABLE D, ARE APPROXIMATE AND MAY NEED ADJUSTING AS DIRECTED BY THE ENGINEER.
- 3A. THE "WORK ZONE BEGINS" (R5-18c) SIGN SHALL BE USED ONLY IN THE INITIAL SIGNING SEQUENCE IN THE WORK ZONE. SUBSEQUENT SEQUENCES IN THE SAME WORK ZONE SHALL OMIT THIS SIGN AND THE QUANTITIES SHALL BE ADJUSTED APPROPRIATELY.
- 4A. THE MAXIMUM RECOMMENDED DISTANCE(S) BETWEEN CHANNELIZING DEVICES IN THE TAPER AREA(S) SHOULD BE 15 FEET AND SHOULD BE EQUAL IN FEET TO TWICE THE POSTED SPEED IN MILES PER HOUR IN THE PARALLEL AREA(S).
5. FOR OVERNIGHT CLOSURES, TYPE III BARRICADES SHALL BE LIGHTED.
6. WHEN CALLED FOR IN THE FHWA ACCEPTANCE LETTER FOR THE SIGN SYSTEM SELECTED, THE TYPE A WARNING FLASHER, SHOWN ON THE WARNING SIGNS, SHALL BE POSITIONED ON THE SIDE OF THE SIGN NEAREST THE ROADWAY.
7. ALL TEMPORARY SIGNS, TYPE III BARRICADES, THEIR SUPPORT SYSTEMS AND LIGHTING REQUIREMENTS SHALL MEET NCHRP 350 CRASHWORTHLY REQUIREMENTS STIPULATED IN THE CURRENT EDITION OF THE MICHIGAN MANUAL ON UNIFORM TRAFFIC CONTROL DEVICES, THE CURRENT EDITION OF THE STANDARD SPECIFICATIONS FOR CONSTRUCTION, THE STANDARD PLANS AND APPLICABLE SPECIAL PROVISIONS. ONLY DESIGNS AND MATERIALS APPROVED BY MDOT WILL BE ALLOWED.
9. ALL TRAFFIC REGULATORS SHALL BE PROPERLY TRAINED AND SUPERVISED.
- 9A. IN ANY OPERATION INVOLVING MORE THAN ONE TRAFFIC REGULATOR, ONE PERSON SHOULD BE DESIGNATED AS HEAD TRAFFIC REGULATOR.
10. ALL TRAFFIC REGULATORS' CONDUCT, THEIR EQUIPMENT, AND TRAFFIC REGULATING PROCEDURES SHALL CONFORM TO THE CURRENT EDITION OF THE MICHIGAN MANUAL OF UNIFORM TRAFFIC CONTROL DEVICES (MMUTCD) AND THE CURRENT EDITION OF THE MDOT HANDBOOK ENTITLED "TRAFFIC REGULATORS INSTRUCTION MANUAL."
11. WHEN TRAFFIC REGULATING IS ALLOWED DURING THE HOURS OF DARKNESS, APPROPRIATE LIGHTING SHALL BE PROVIDED TO SUFFICIENTLY ILLUMINATE THE TRAFFIC REGULATOR'S STATIONS.
- 12E. THE MAXIMUM DISTANCE BETWEEN THE TRAFFIC REGULATORS SHALL BE NO MORE THAN 2 MILES IN LENGTH UNLESS RESTRICTED FURTHER IN THE SPECIAL PROVISIONS FOR MAINTAINING TRAFFIC. ALL SEQUENCES OF MORE THAN 2 MILES IN LENGTH WILL REQUIRE WRITTEN PERMISSION FROM THE ENGINEER BEFORE PROCEEDING.
13. WHEN INTERSECTING ROADS OR SIGNIFICANT TRAFFIC GENERATORS (SHOPPING CENTERS, MOBILE HOME PARKS, ETC.) OCCUR WITHIN THE ONE-LANE TWO-WAY OPERATION, INTERMEDIATE TRAFFIC REGULATORS AND APPROPRIATE SIGNING SHALL BE PLACED AT THESE LOCATIONS.
14. ADDITIONAL SIGNING AND/OR ELONGATED SIGNING SEQUENCES SHOULD BE USED WHEN TRAFFIC VOLUMES ARE SIGNIFICANT ENOUGH TO CREATE BACKUPS BEYOND THE W3-4 SIGNS.
15. THE HAND HELD (PADDLE) SIGNS REQUIRED BY THE MMUTCD TO CONTROL TRAFFIC WILL BE PAID FOR AS PART OF FLAG CONTROL.
- 28E. THE TRAFFIC REGULATORS SHOULD BE POSITIONED AT OR NEAR THE SIDE OF THE ROAD SO THAT THEY ARE SEEN CLEARLY AT A MINIMUM DISTANCE OF 500 FEET. THIS MAY REQUIRE EXTENDING THE BEGINNING OF THE LANE CLOSURE TO OVERCOME VIEWING PROBLEMS CAUSED BY HILLS AND CURVES.

SIGN SIZES

DIAMOND WARNING - 48" x 48"
 R2-1 REGULATORY - 48" x 60"
 R5-18c REGULATORY - 48" x 48"

NOT TO SCALE

 TRAFFIC AND SAFETY MAINTAINING TRAFFIC TYPICAL	TYPICAL TEMPORARY TRAFFIC CONTROL FOR A TWO-LANE TWO-WAY ROADWAY WHERE ONE LANE IS CLOSED UTILIZING TRAFFIC REGULATORS, NO SPEED REDUCTION		
DRAWN BY: CON:AE:djf	OCTOBER 2011	M0140a	SHEET
CHECKED BY: BMM:CRB	PLAN DATE:		2 OF 2
FILE: PW RD/TS/Typicals/Signs/MT NON FWY/M0140a.dgn REV. 10/04/2011			

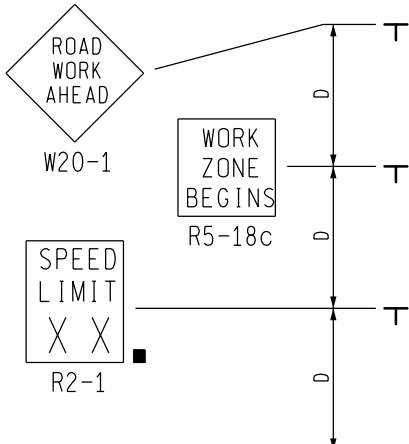

NO SPEED REDUCTION
THIS DIRECTION

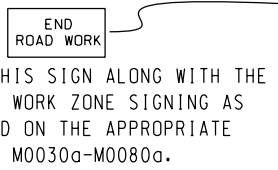
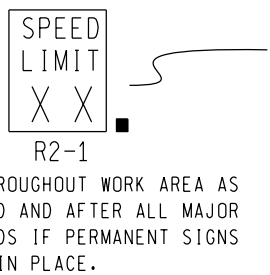

- KEY**
- • • CHANNELIZING DEVICES
 - ← LIGHTED ARROW PANEL
 - TRAFFIC FLOW
 - REFLECTS EXISTING SPEED LIMIT

SIGN = 172 f+2 - TYPE B PLUS ADDITIONAL R2-1'S THROUGHOUT WORK AREA

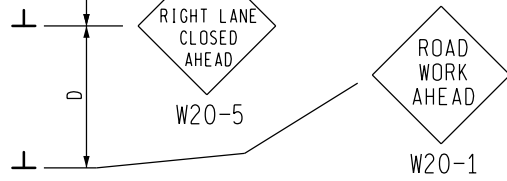
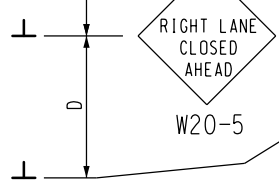
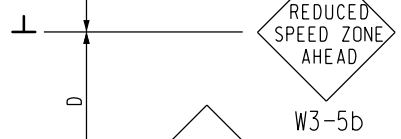
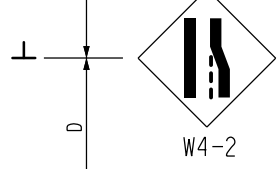
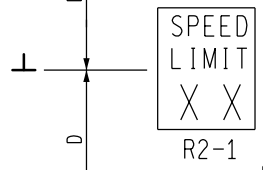
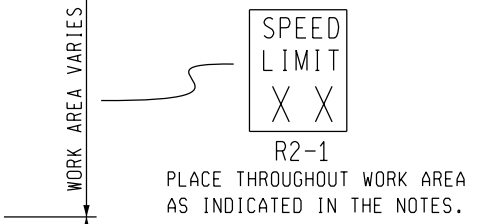
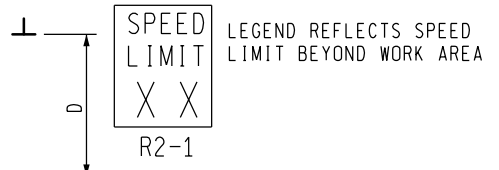
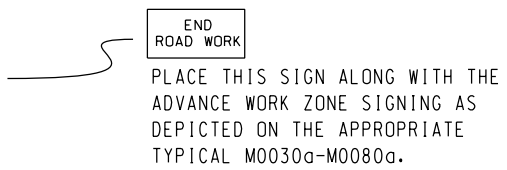
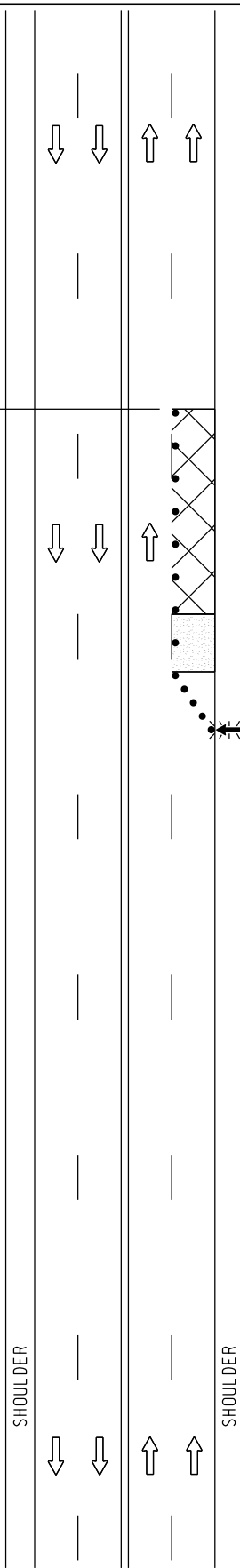

↑ MAXIMUM 10MPH SPEED REDUCTION THIS DIRECTION

MDOT
Michigan Department of Transportation
TRAFFIC AND SAFETY
MAINTAINING TRAFFIC
TYPICAL

TYPICAL TEMPORARY TRAFFIC CONTROL FOR A ONE-LANE CLOSURE ON AN UNDIVIDED MULTI-LANE ROADWAY USING A SINGLE STEP DOWN IN SPEED LIMIT IN ONE DIRECTION ONLY

DRAWN BY: CON:AE:djf
CHECKED BY: BMM:CRB

OCTOBER 2011
PLAN DATE:

M0250a

SHEET
1 OF 2

NOT TO SCALE

NOTES

- 1B. D = DISTANCE BETWEEN TRAFFIC CONTROL DEVICES
 L = MINIMUM LENGTH OF TAPER
 B = LENGTH OF LONGITUDINAL BUFFER
 SEE **M0020a** FOR "D," "L," AND "B" VALUES
2. ALL NON-APPLICABLE SIGNING WITHIN THE CIA SHALL BE MODIFIED TO FIT CONDITIONS, COVERED OR REMOVED.
3. DISTANCES BETWEEN SIGNS, THE VALUES FOR WHICH ARE SHOWN IN TABLE D, ARE APPROXIMATE AND MAY NEED ADJUSTING AS DIRECTED BY THE ENGINEER.
- 3A. THE "WORK ZONE BEGINS" (R5-18c) SIGN SHALL BE USED ONLY IN THE INITIAL SIGNING SEQUENCE IN THE WORK ZONE. SUBSEQUENT SEQUENCES IN THE SAME WORK ZONE SHALL OMIT THIS SIGN AND THE QUANTITIES SHALL BE ADJUSTED APPROPRIATELY.
- 4E. THE MAXIMUM RECOMMENDED DISTANCE(S) BETWEEN CHANNELIZING DEVICES SHOULD BE EQUAL IN FEET TO THE POSTED SPEED IN MILES PER HOUR ON TAPER(S) AND TWICE THE POSTED SPEED IN THE PARALLEL AREA(S).
5. FOR OVERNIGHT CLOSURES, TYPE III BARRICADES SHALL BE LIGHTED.
6. WHEN CALLED FOR IN THE FHWA ACCEPTANCE LETTER FOR THE SIGN SYSTEM SELECTED, THE TYPE A WARNING FLASHER, SHOWN ON THE WARNING SIGNS, SHALL BE POSITIONED ON THE SIDE OF THE SIGN NEAREST THE ROADWAY.
7. ALL TEMPORARY SIGNS, TYPE III BARRICADES, THEIR SUPPORT SYSTEMS AND LIGHTING REQUIREMENTS SHALL MEET NCHRP 350 CRASHWORTHY REQUIREMENTS STIPULATED IN THE CURRENT EDITION OF THE MICHIGAN MANUAL ON UNIFORM TRAFFIC CONTROL DEVICES, THE CURRENT EDITION OF THE STANDARD SPECIFICATIONS FOR CONSTRUCTION, THE STANDARD PLANS AND APPLICABLE SPECIAL PROVISIONS. ONLY DESIGNS AND MATERIALS APPROVED BY MDOT WILL BE ALLOWED.
8. WHEN BUFFER AREAS ARE ESTABLISHED, THERE SHALL BE NO EQUIPMENT OR MATERIALS STORED OR WORK CONDUCTED IN THE BUFFER AREA.
- 16A. ADDITIONAL SPEED LIMIT SIGNS REFLECTING THE REDUCED SPEED SHALL BE PLACED AFTER EACH MAJOR CROSSROAD THAT INTERSECTS THE WORK AREA WHERE THE REDUCED SPEED IS IN EFFECT, AND AT INTERVALS ALONG THE ROADWAY SUCH THAT NO SPEED LIMIT SIGNS REFLECTING THE REDUCED SPEED ARE MORE THAN TWO MILES APART.
- 16B. WHEN REDUCED SPEED LIMITS ARE UTILIZED IN THE WORK AREA, ADDITIONAL SPEED LIMIT SIGNS RETURNING TRAFFIC TO ITS NORMAL SPEED SHALL BE PLACED BEYOND THE LIMITS OF THE REDUCED SPEED AS INDICATED.
- 16E. WHEN EXISTING SPEED LIMITS ARE REDUCED MORE THAN 10 MPH, THE SPEED LIMIT SHALL BE STEPPED DOWN IN NO MORE THAN 10 MPH INCREMENTS.
21. ALL EXISTING PAVEMENT MARKINGS WHICH ARE IN CONFLICT WITH EITHER PROPOSED CHANGES IN TRAFFIC PATTERNS OR PROPOSED TEMPORARY TRAFFIC MARKINGS, SHALL BE REMOVED BEFORE ANY CHANGE IS MADE IN THE TRAFFIC PATTERN. EXCEPTION WILL BE MADE FOR DAYTIME-ONLY TRAFFIC PATTERNS THAT ARE ADEQUATELY DELINEATED BY OTHER TRAFFIC CONTROL DEVICES.
26. THE LIGHTED ARROW PANEL SHALL BE LOCATED AT THE BEGINNING OF THE TAPER AS SHOWN. WHEN PHYSICAL LIMITATIONS RESTRICT ITS PLACEMENT AS INDICATED, THEN IT SHALL BE PLACED AS CLOSE TO THE BEGINNING OF THE TAPER AS POSSIBLE.

SIGN SIZES

DIAMOND WARNING - 48" x 48"
 RECTANGULAR REGULATORY - 48" x 60"
 R5-18c REGULATORY - 48" x 48"

NOT TO SCALE

 TRAFFIC AND SAFETY MAINTAINING TRAFFIC TYPICAL	TYPICAL TEMPORARY TRAFFIC CONTROL FOR A ONE-LANE CLOSURE ON AN UNDIVIDED MULTI-LANE ROADWAY USING A SINGLE STEP DOWN IN SPEED LIMIT IN ONE DIRECTION ONLY		
DRAWN BY: CON:AE:djf	OCTOBER 2011	M0250a	SHEET
CHECKED BY: BMM:CRB	PLAN DATE:		2 OF 2
FILE: PW RD/TS/Typicals/Signs/MT NON FWY/M0250a.dgn REV. 10/11/2011			

SIGN MATERIAL SELECTION TABLE

SIGN SIZE	SIGN MATERIAL TYPE		
	TYPE I	TYPE II	TYPE III
≤ 36" X 36"		X	X
>36" X 36" ≤ 96" TO WIDE		X	
> 96" WIDE TO 144" WIDE	X	X	
> 144" WIDE	X		

TYPE I ALUMINUM EXTRUSION
 TYPE II PLYWOOD
 TYPE III ALUMINUM SHEET

ROUNDING OF CORNERS IS NOT REQUIRED FOR TYPE I OR II SIGNS.
 VERTICAL JOINTS ARE NOT PERMITTED.
 HORIZONTAL JOINTS THROUGH SIGN LEGEND OR SYMBOLS ARE NOT PERMITTED.

POST SIZE REQUIREMENTS TABLE

SIGN AREA (ft ²)	POST TYPE		
	U-CHANNEL STEEL	SQUARE TUBULAR STEEL	WOOD
≤9	1 - 3 lb/ft*	1 - 2" 12 or 14 GA*	N/A
9 ≤ 20	2 - 3 lb/ft	2 - 2" 12 or 14 GA	1 - 4" X 6"*
> 20 ≤ 30	N/A	N/A	2 - 4" X 6"
> 30 ≤ 60	N/A	N/A	2 - 6" X 8"
> 60 ≤ 84	N/A	N/A	3 - 6" X 8"

*SIGNS 4 FEET AND GREATER IN WIDTH REQUIRE 2 POSTS.
 SIGNS GREATER THAN 8 FEET IN WIDTH REQUIRE 2 OR 3 WOOD
 POSTS DEPENDING ON AREA OF SIGN.
 A MAXIMUM OF 2 POSTS WITHIN A 7' PATH IS PERMITTED.

NOT TO SCALE

File:PW/Doc/RD/T&S/Typ/Dev/Sign MainTraf D/WZD-100-A Rev. 8/21/06 ECH

 Michigan Department of Transportation PREPARED BY TRAFFIC AND SAFETY SUPPORT AREA DRAWN BY: CON/ECH CHECKED BY: AUG	_____ ENGINEER OF DELIVERY _____ ENGINEER OF DEVELOPMENT PENDING _____ FHWA APPROVAL DATE	MICHIGAN DEPARTMENT OF TRANSPORTATION BUREAU OF HIGHWAYS DELIVERY STANDARD PLAN FOR GROUND DRIVEN SIGN SUPPORTS FOR TEMP SIGNS		
	8/2006	WZD-100-A	SHEET	
	PLAN DATE		1 of 11	

NOTE: THE ORIGINAL SIGNED COPY IS KEPT ON FILE AT THE MICHIGAN DEPARTMENT OF TRANSPORTATION.

2 POST SIGN SUPPORT SPACING

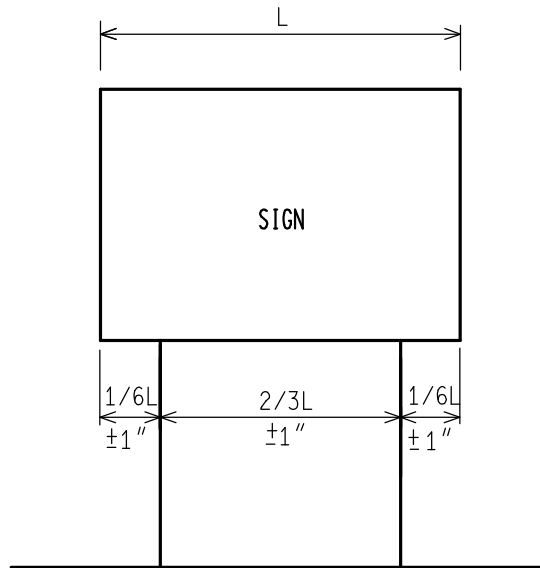

3 POST SIGN SUPPORT SPACING

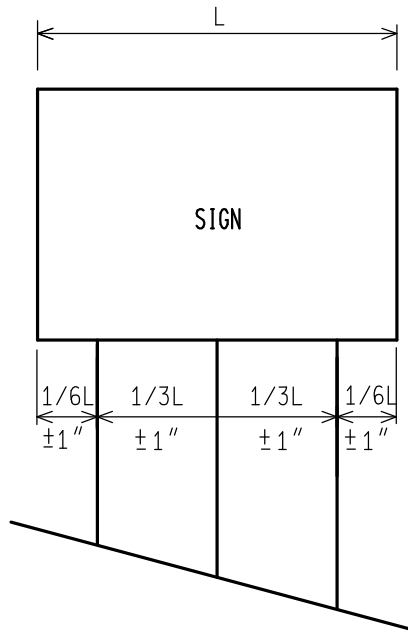

* FOR ALL 11' AND 12' LONG SIGNS ON 3 WOOD SUPPORTS, SPREAD POSTS SO AS TO HAVE A 8' MIN. TO 9' MAX. DISTANCE BETWEEN OUTSIDE POSTS.

NOT TO SCALE

MICHIGAN DEPARTMENT OF TRANSPORTATION
BUREAU OF HIGHWAYS DELIVERY STANDARD PLAN

PENDING
FHWA APPROVAL DATE

8/2006
PLAN DATE

WZD-100-A

SHEET
2 of 11

File:PW/Doc/RD/T&S/Typ/Dev/Sign MainTraf D/WZD-100-A Rev. 8/21/06 ECH

NOTE: THE ORIGINAL SIGNED COPY IS KEPT ON FILE AT THE MICHIGAN DEPARTMENT OF TRANSPORTATION.

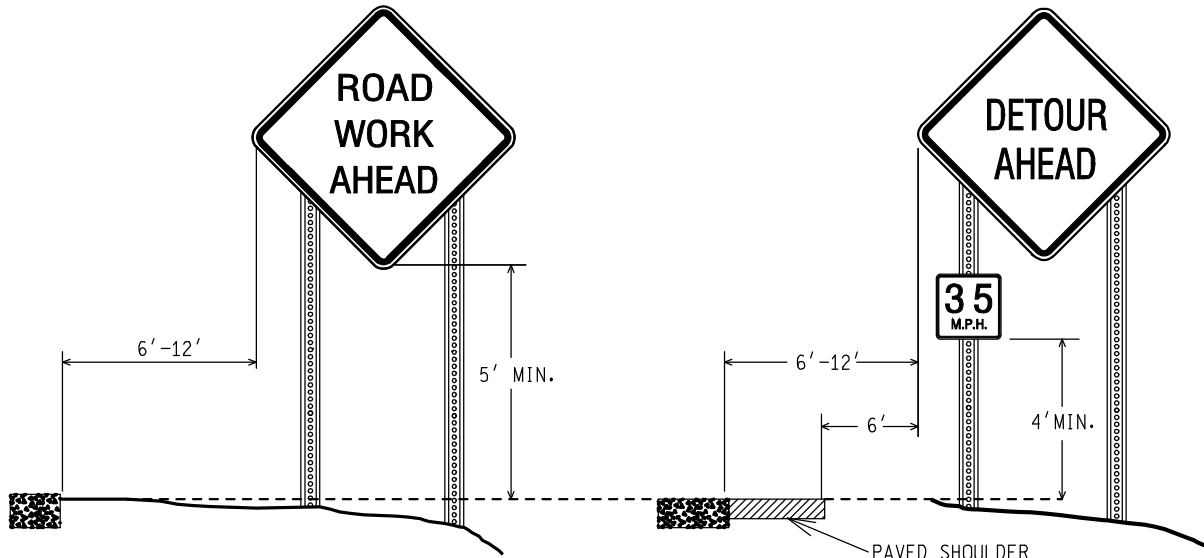

RURAL

RURAL WITH ADVISORY SPEED PLATE

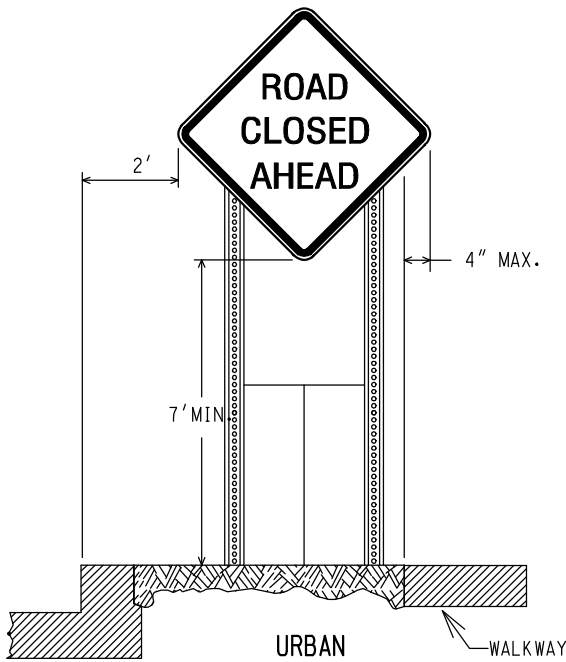

URBAN

WALKWAY

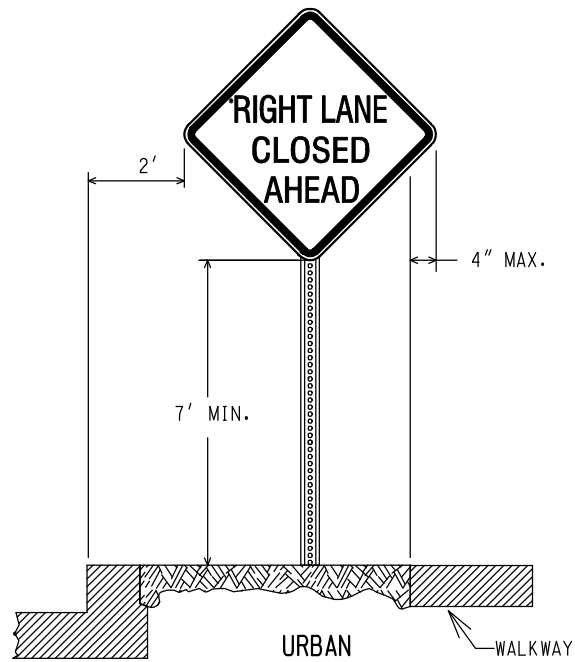

URBAN

WALKWAY

(CURBED AREAS OR WHERE WALKWAYS ARE PRESENT)

(CURBED AREAS OR WHERE WALKWAYS ARE PRESENT)

BOTTOM HEIGHT AND OFFSET

NOT TO SCALE

MICHIGAN DEPARTMENT OF TRANSPORTATION
BUREAU OF HIGHWAYS DELIVERY STANDARD PLAN

PENDING
FHWA APPROVAL DATE

8/2006

PLAN DATE

WZD-100-A

SHEET
3 of 11

NOTE: THE ORIGINAL SIGNED COPY IS KEPT ON FILE AT THE MICHIGAN DEPARTMENT OF TRANSPORTATION.

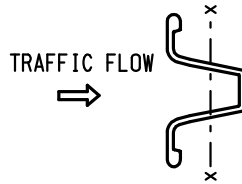
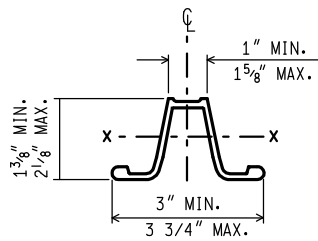
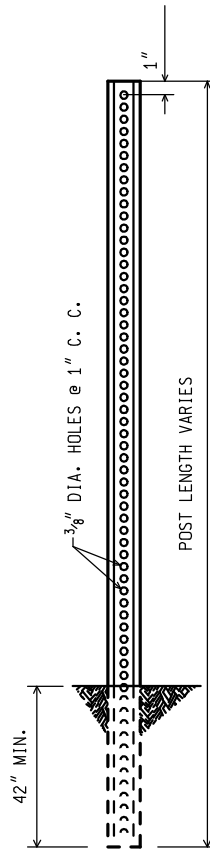

WEIGHT = 3 lbs/ft
 SECT. MOD. X.-X. = 0.31 CUBIC INCHES MIN.

3 lb. U - CHANNEL STEEL POST (NO SPLICE)

MOUNT SIGN ON OPEN FACE OF
 U - CHANNEL STEEL POST

NOT TO SCALE

MICHIGAN DEPARTMENT OF TRANSPORTATION
 BUREAU OF HIGHWAYS DELIVERY STANDARD PLAN

PENDING

 FHWA APPROVAL DATE

8/2006

 PLAN DATE

WZD-100-A

SHEET
 4 of 11

File:PW/Doc/RD/T&S/Typ/Dev/Sign MainTraf D/WZD-100-A Rev. 8/21/06 ECH

NOTE: THE ORIGINAL SIGNED COPY IS KEPT ON FILE AT THE MICHIGAN DEPARTMENT OF TRANSPORTATION.

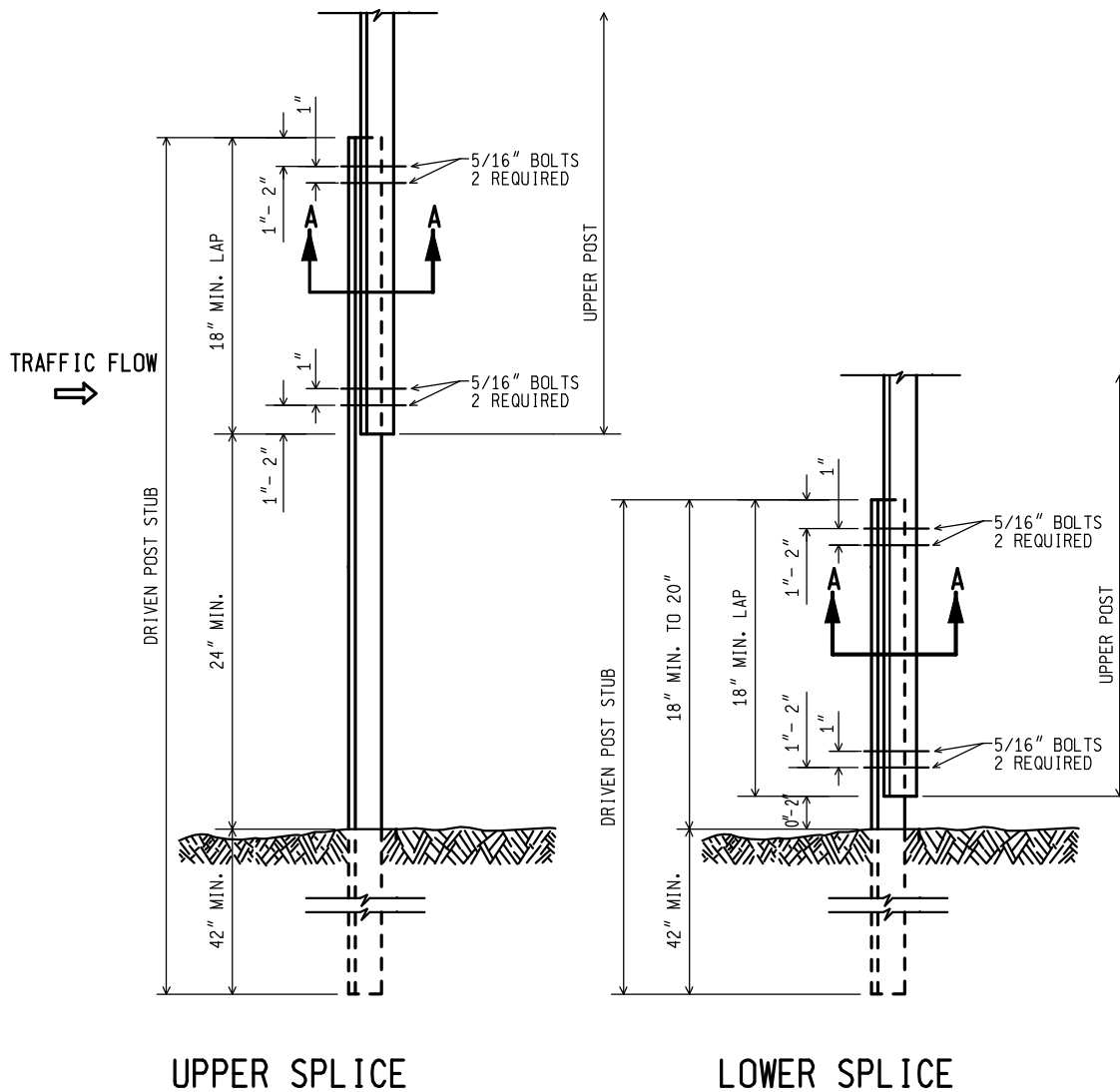

**3 lb. U - CHANNEL STEEL POST
(WITH SPLICE)**

MOUNT SIGN ON OPEN FACE OF
UPPER U - CHANNEL STEEL POST

NOT TO SCALE

MICHIGAN DEPARTMENT OF TRANSPORTATION
BUREAU OF HIGHWAYS DELIVERY STANDARD PLAN

PENDING
FHWA APPROVAL DATE

8/2006
PLAN DATE

WZD-100-A

SHEET
5 of 11

File:PW/Doc/RD/T&S/Typ/Dev/Sign MainTraf D/WZD-100-A Rev. 8/21/06 ECH

NOTE: THE ORIGINAL SIGNED COPY IS KEPT ON FILE AT THE MICHIGAN DEPARTMENT OF TRANSPORTATION.

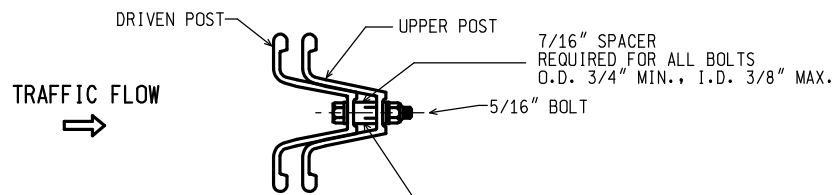

SECTION A-A

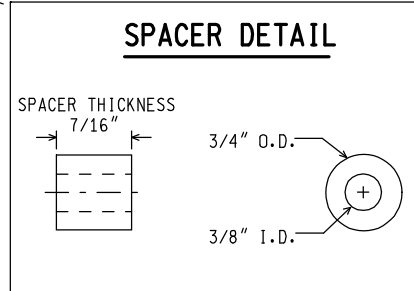

NOTES:

1. THE SPACER THICKNESS SHALL BE 1/16" LESS THAN THE GAP BETWEEN THE POST WHEN POSITIONED IN THE UNBOLTED CONFIGURATION.
2. THE EXTERIOR BOLT (CLOSEST TO LAP), SPACER, WASHER, AND NUT SHALL BE INSTALLED IN A PREPUNCHED HOLE 1" TO 2" FROM THE END OF THE LAP.
3. THE INTERIOR BOLT (FARTHEST FROM LAP), SPACER, WASHER, AND NUT SHALL BE INSTALLED IN THE NEXT PREPUNCHED HOLE.
4. THE DRIVEN POST SHALL ALWAYS BE MOUNTED IN FRONT OF THE UPPER POST WITH RESPECT TO THE ADJACENT ONCOMING TRAFFIC, REGARDLESS OF THE DIRECTION THE SIGN IS FACING.
5. THE SPLICE LAP SHALL BE FASTENED BY FOUR-5/16" DIA. GALVANIZED A449 BOLTS (SAE J429 GRADE 5) OR GALVANIZED A325 BOLTS.

3 lb. U - CHANNEL STEEL POST
(WITH SPLICE)

NOT TO SCALE

MICHIGAN DEPARTMENT OF TRANSPORTATION BUREAU OF HIGHWAYS DELIVERY STANDARD PLAN	PENDING FHWA APPROVAL DATE	8/2006 PLAN DATE	WZD-100-A	SHEET 6 of 11
File:PW/Doc/RD/T&S/Typ/Dev/Sign MainTraf D/WZD-100-A Rev. 8/21/06 ECH				

NOTE: THE ORIGINAL SIGNED COPY IS KEPT ON FILE AT THE MICHIGAN DEPARTMENT OF TRANSPORTATION.

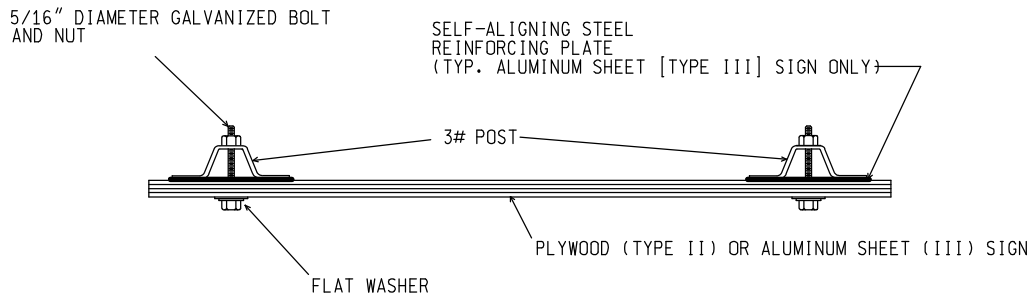

SIGN TO 3 lb. POST CONNECTION

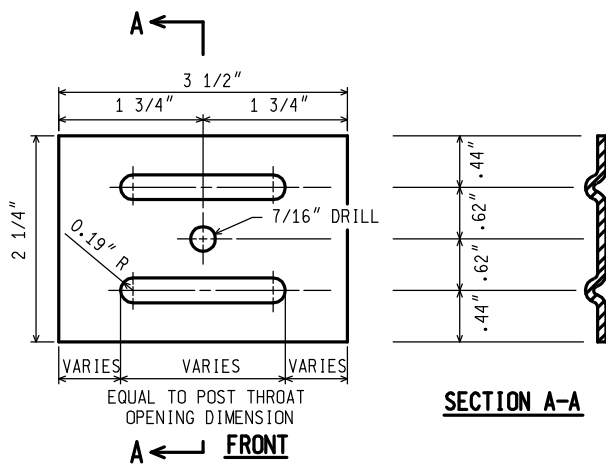

NOTES: (FOR STEEL SIGN REINF' PLATE)

1. MATERIAL: 12 GAUGE CARBON STEEL.
2. TOLERANCE ON ALL DIMENSIONS $\pm 0.0625"$
3. FINISH-AFTER STAMPING AND PUNCHING, GALVANIZE ACCORDING TO CURRENT SPECIFICATIONS FOR ZINC (HOT GALVANIZE) COATINGS ON PRODUCTS FABRICATED FROM PLATES OR STRIPS

STEEL SIGN REINFORCING PLATE
REQUIRED FOR TYPE III SIGNS ONLY

3 lb. U - CHANNEL STEEL POST SIGN CONNECTION

NOT TO SCALE

MICHIGAN DEPARTMENT OF TRANSPORTATION BUREAU OF HIGHWAYS DELIVERY STANDARD PLAN	PENDING FHWA APPROVAL DATE	8/2006 PLAN DATE	WZD-100-A	SHEET 7 of 11
File:PW/Doc/RD/T&S/Typ/Dev/Sign MainTraf D/WZD-100-A Rev. 8/21/06 ECH				

NOTE: THE ORIGINAL SIGNED COPY IS KEPT ON FILE AT THE MICHIGAN DEPARTMENT OF TRANSPORTATION.

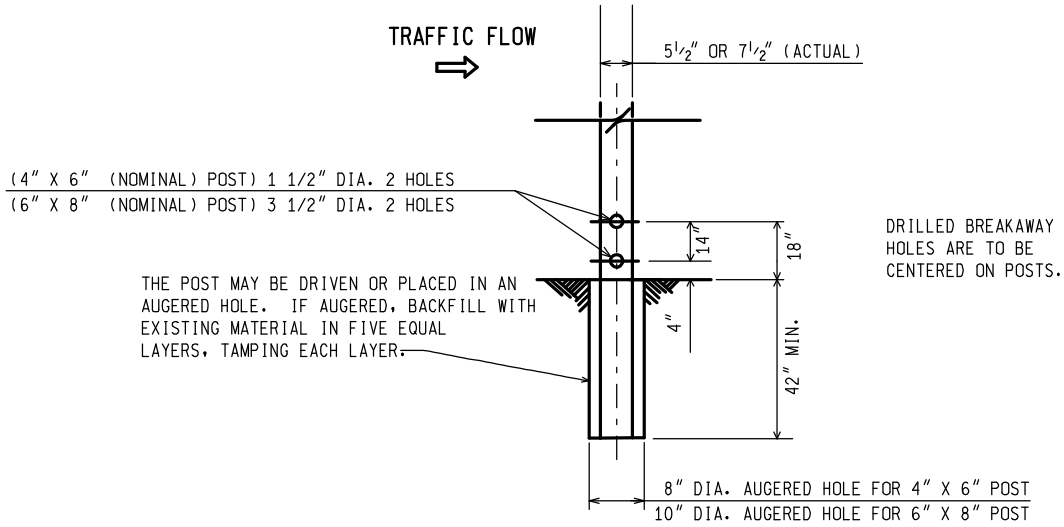

**WOOD POST BREAKAWAY HOLES/
 DIRECT EMBEDMENT DETAILS**

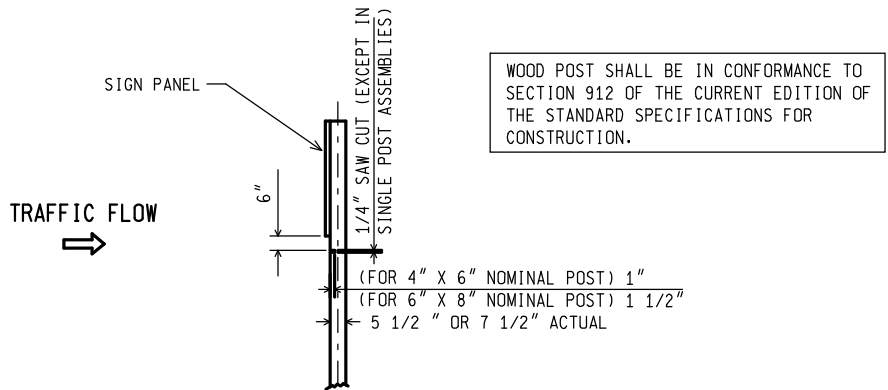

**SAW CUT DETAIL
 (MULTIPLE POST INSTALLATIONS)**

WOOD POST DETAILS

NOT TO SCALE

MICHIGAN DEPARTMENT OF TRANSPORTATION
 BUREAU OF HIGHWAYS DELIVERY STANDARD PLAN

PENDING
 FHWA APPROVAL DATE

8/2006
 PLAN DATE

WZD-100-A

SHEET
 8 of 11

File:PW/Doc/RD/T&S/Typ/Dev/Sign MainTraf D/WZD-100-A Rev. 8/21/06 ECH

NOTE: THE ORIGINAL SIGNED COPY IS KEPT ON FILE AT THE MICHIGAN DEPARTMENT OF TRANSPORTATION.

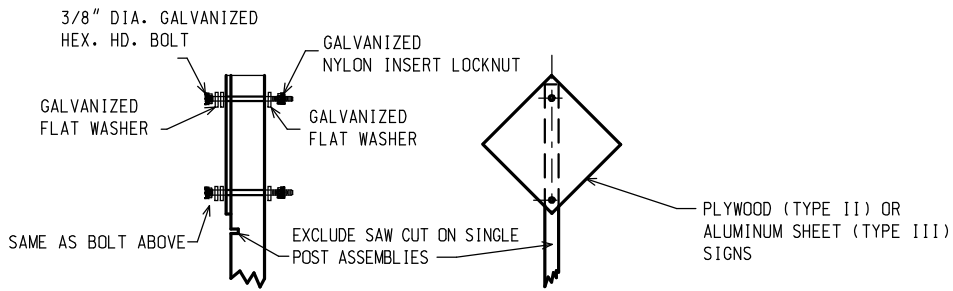

TYPE II AND TYPE III SIGNS

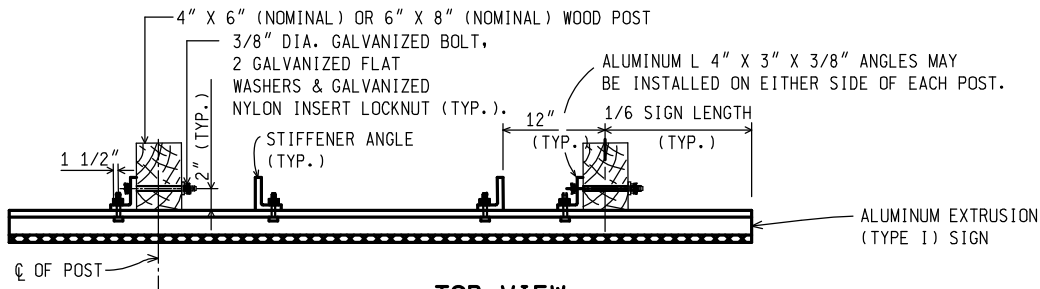

**TOP VIEW
 TYPE I SIGN**

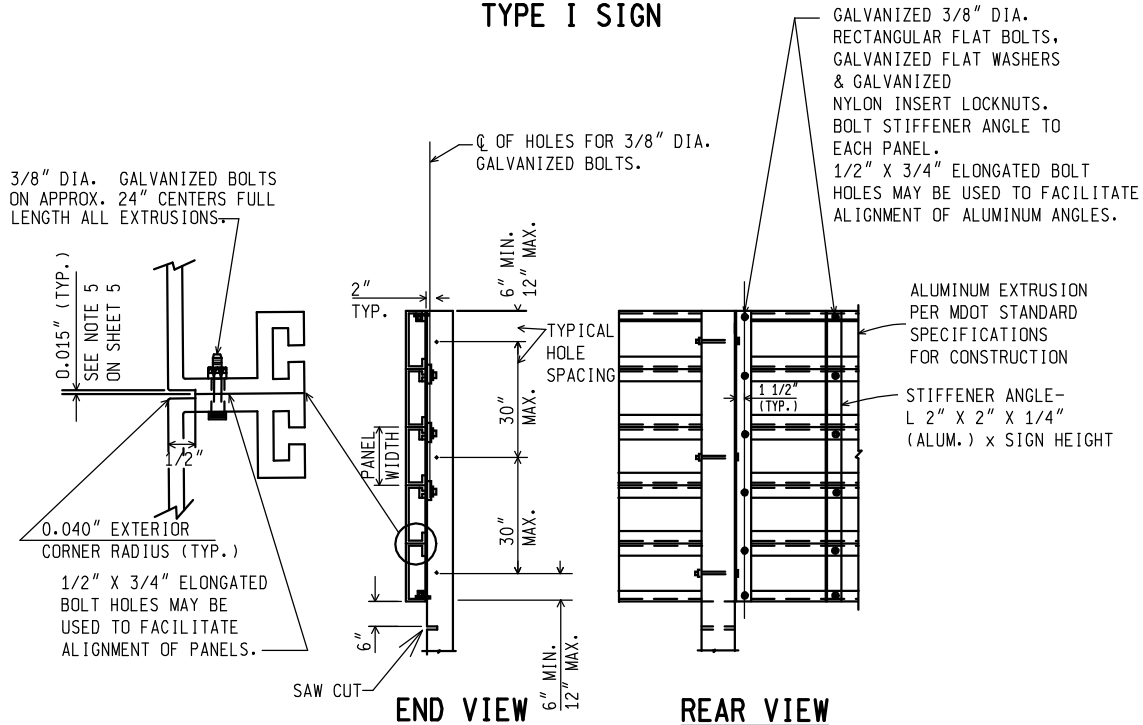

TYPE I SIGN - ERECTION DETAILS

WOOD POST CONNECTIONS

NOT TO SCALE

MICHIGAN DEPARTMENT OF TRANSPORTATION
 BUREAU OF HIGHWAYS DELIVERY STANDARD PLAN

PENDING
 FHWA APPROVAL DATE

8/2006

PLAN DATE

WZD-100-A

SHEET
 9 of 11

File:PW/Doc/RD/T&S/Typ/Dev/Sign MainTraf D/WZD-100-A Rev. 8/21/06 ECH

NOTE: THE ORIGINAL SIGNED COPY IS KEPT ON FILE AT THE MICHIGAN DEPARTMENT OF TRANSPORTATION.

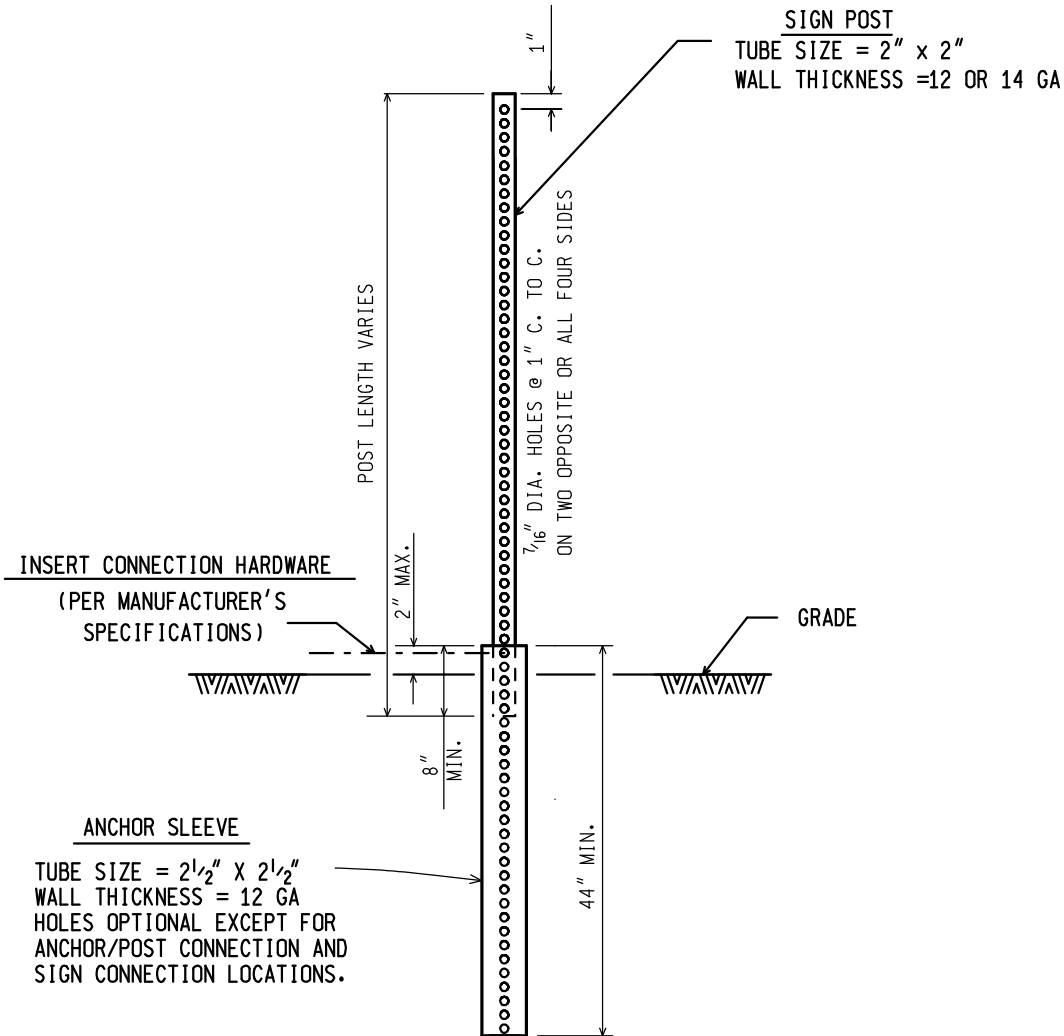

SQUARE TUBULAR STEEL POST

NOT TO SCALE

MICHIGAN DEPARTMENT OF TRANSPORTATION
 BUREAU OF HIGHWAYS DELIVERY STANDARD PLAN

PENDING
 FHWA APPROVAL DATE

8/2006

PLAN DATE

WZD-100-A

SHEET
 10 of 11

File:PW/Doc/RD/T&S/Typ/Dev/Sign MainTraf D/WZD-100-A Rev. 8/21/06 ECH

NOTE: THE ORIGINAL SIGNED COPY IS KEPT ON FILE AT THE MICHIGAN DEPARTMENT OF TRANSPORTATION.

GENERAL NOTES:

1. A MAXIMUM OF TWO POSTS WITHIN A 7 FOOT PATH IS PERMITTED.
2. ALL SIGN POSTS SHALL COMPLY WITH NCHRP 350.
3. ALL POSTS SHALL BE EMBEDDED A MINIMUM OF 42".
4. BRACING OF POST IS NOT PERMITTED.
5. SIGN SHALL BE LEVEL, AND UPRIGHT FOR THE DURATION OF INSTALLATION.
6. ERECT POSTS SO THE SIGN FACE AND SUPPORTS DO NOT VARY FROM PLUMB BY MORE THAN 3/16" IN 3'. PROVIDE A CENTER-TO-CENTER DISTANCE BETWEEN POSTS WITHIN 2 PERCENT OF PLAN DISTANCE.
7. NO MORE THAN ONE SPLICE PER POST, AS SHOWN, WILL BE PERMITTED.
8. POST TYPES SHALL NOT BE MIXED WITHIN A SIGN SUPPORT INSTALLATION.
9. NO VERTICAL JOINTS ARE PERMITTED IN SIGN. NO HORIZONTAL JOINTS THROUGH SIGN LEGEND OR SYMBOLS ARE PERMITTED IN SIGN
10. REMOVE SIGN POSTS AND/OR POST STUBS IN THEIR ENTIRETY WHEN NO LONGER REQUIRED.
11. ALL LABOR, MATERIALS, AND EQUIPMENT, INCLUDING TEMPORARY SUPPORTS REQUIRED TO INSTALL, MAINTAIN, RELOCATE, COVER, AND/OR REMOVE THE TEMPORARY SIGN, INCLUDING SUPPORTS, ARE CONSIDERED TO BE INCLUDED IN THE COST OF THE TEMPORARY SIGN.
12. SAW CUTS IN WOOD POSTS ARE TO BE PARALLEL TO THE BOTTOM OF THE SIGN.
13. POSTS SHALL NOT EXTEND MORE THAN 4" ABOVE TOP OF SIGN.

NOT TO SCALE

MICHIGAN DEPARTMENT OF TRANSPORTATION BUREAU OF HIGHWAYS DELIVERY STANDARD PLAN	PENDING FHWA APPROVAL DATE	8/2006 PLAN DATE	WZD-100-A	SHEET 11 of 11
--	-------------------------------	---------------------	-----------	-------------------

NOTE: THE ORIGINAL SIGNED COPY IS KEPT ON FILE AT THE MICHIGAN DEPARTMENT OF TRANSPORTATION.

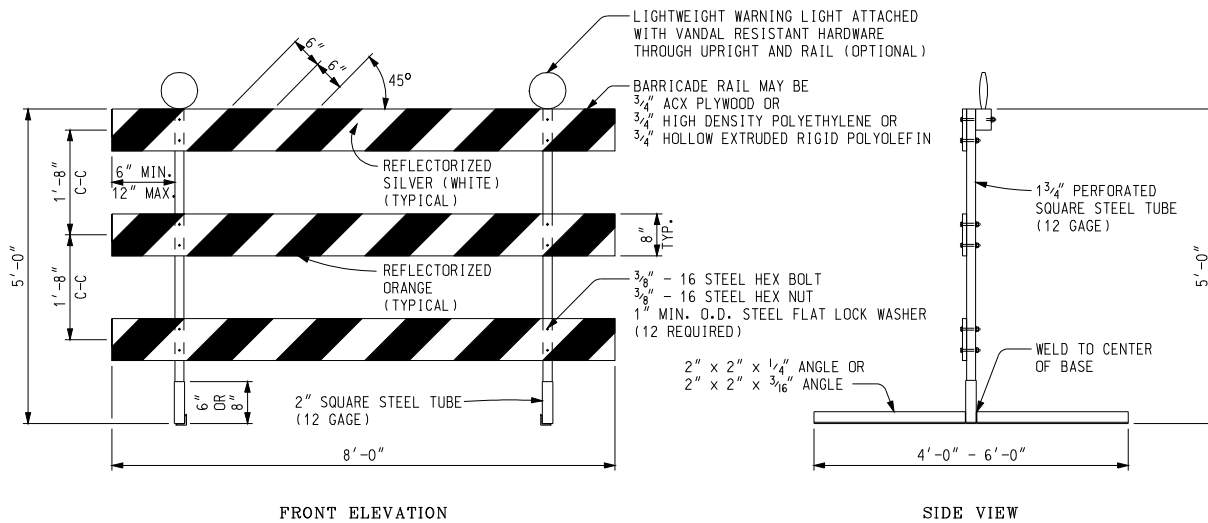

FRONT ELEVATION

SIDE VIEW

PERFORATED SQUARE STEEL TUBE OPTION

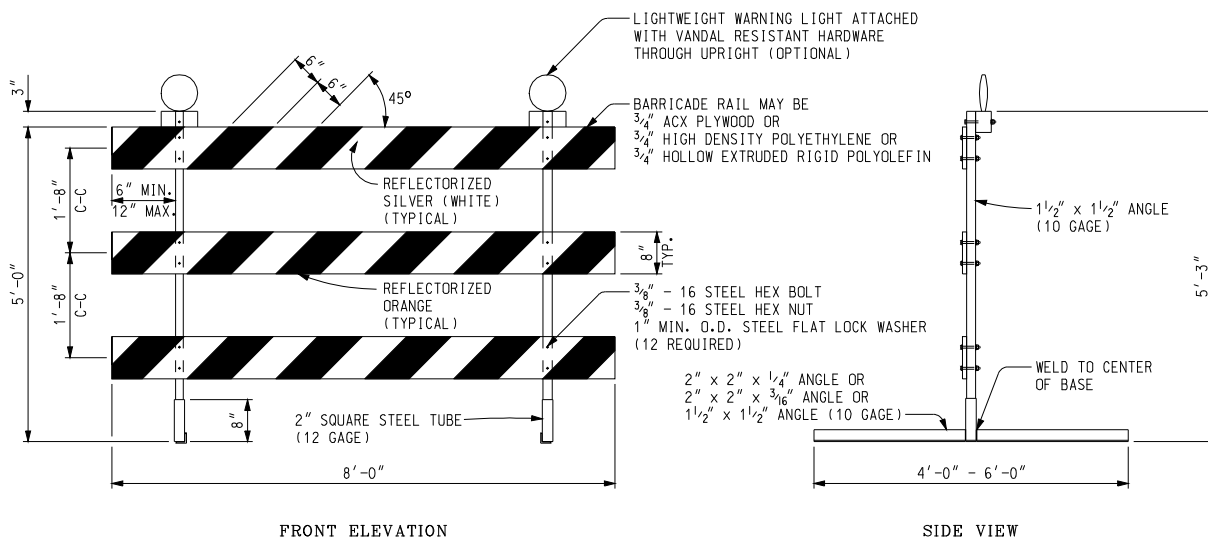

FRONT ELEVATION

SIDE VIEW

ANGLE IRON OPTION

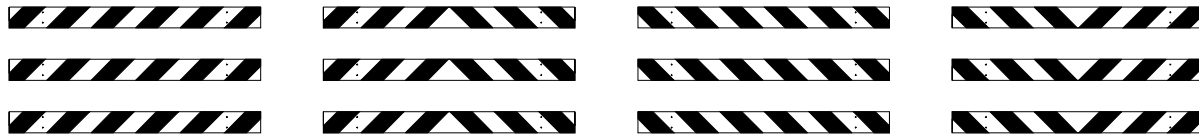

LEFT DIRECTIONAL

BI-DIRECTIONAL

RIGHT DIRECTIONAL

CLOSURES

BARRICADE RAIL SHEETING OPTIONS
TYPE III BARRICADES

Other Type III Barricades meeting current NCHRP crash worthy criteria can be found on the FHWA Safety website at http://safety.fhwa.dot.gov/roadway_dept/road_hardware/wzd.htm

NOT TO SCALE

File: T&S/Typ/Signs/WorkZones/wzd 125 d

Rev. 09/22/09 PJ



PREPARED BY
TRAFFIC AND SAFETY

DRAWN BY: ECH

CHECKED BY: MWB

ENGINEER OF DELIVERY

ENGINEER OF DEVELOPMENT

(SPECIAL DETAIL)

FHWA APPROVAL DATE

MICHIGAN DEPARTMENT OF TRANSPORTATION
BUREAU OF HIGHWAYS DELIVERY STANDARD PLAN FOR

Temporary
Traffic Control Devices

9/22/09
PLAN DATE

WZD-125-E

SHEET
1 of 3

NOTE: THE ORIGINAL SIGNED COPY IS KEPT ON FILE AT THE MICHIGAN DEPARTMENT OF TRANSPORTATION.

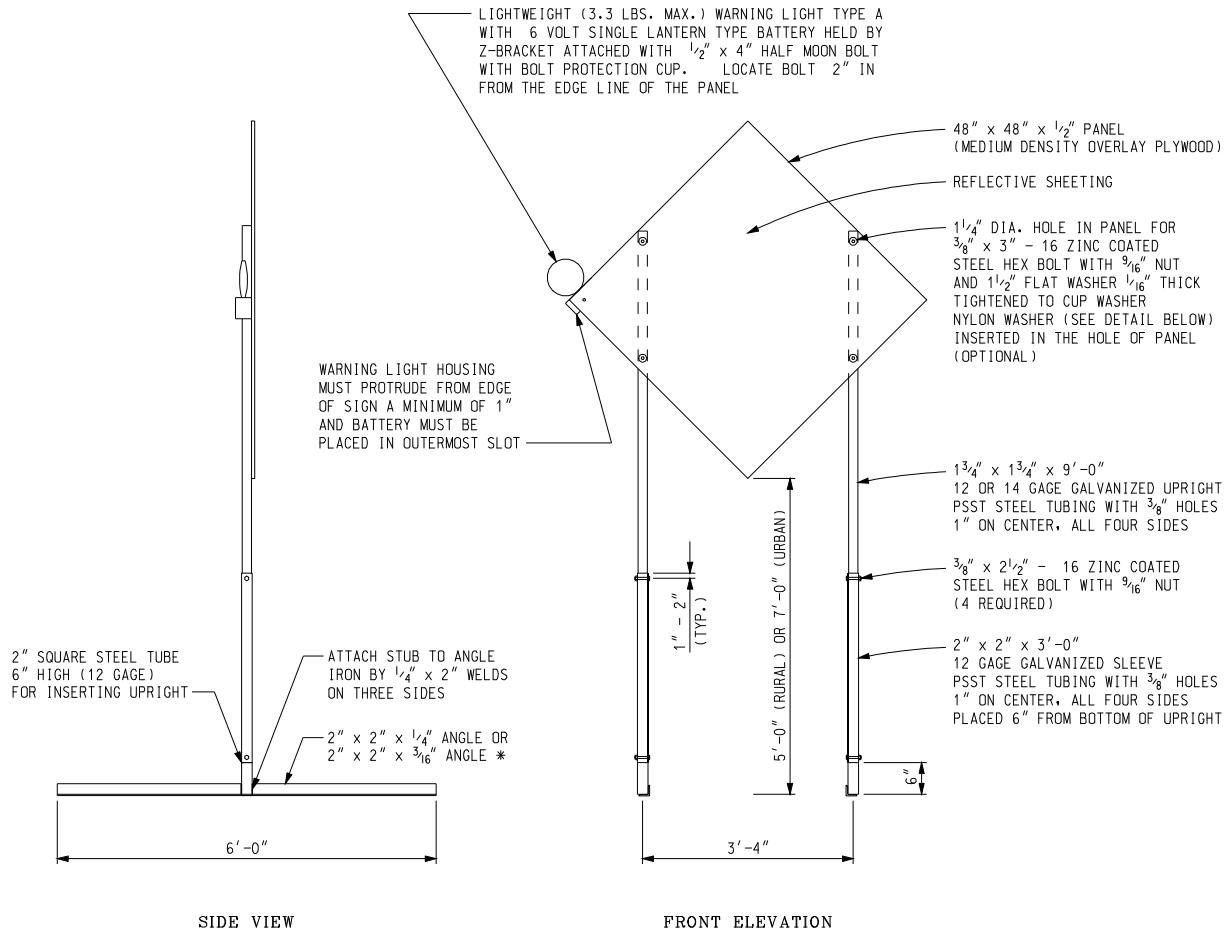

TEMPORARY SIGN SUPPORT

(WARNING LIGHT PLACED ON SIDE CLOSEST TO TRAFFIC)

- * SIGN STAND IS BALLASTED WITH FOUR OR MORE 35 LB SANDBAGS. A MINIMUM OF ONE ON EACH END.
- UPRIGHTS SHALL NOT EXTEND ABOVE THE SIGN PANEL.

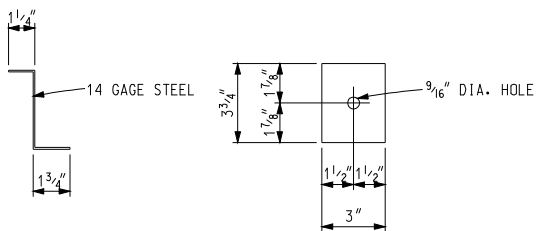

Z-BRACKET DETAIL

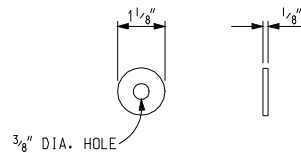

OPTIONAL NYLON WASHER

Other temporary sign supports meeting current NCHRP crash worthy criteria can be found on the FHWA Safety website at http://safety.fhwa.dot.gov/roadway_dept/road_hardware/wzd.htm

NOT TO SCALE

MICHIGAN DEPARTMENT OF TRANSPORTATION
BUREAU OF HIGHWAYS DELIVERY STANDARD PLAN

(SPECIAL DETAIL)
FHWA APPROVAL DATE

9/22/09
PLAN DATE

WZD-125-E

SHEET
2 of 3

File: T&S/Typ/Signs/WorkZones/wzd 125 d

Rev. 09/22/09 PJ

NOTE: THE ORIGINAL SIGNED COPY IS KEPT ON FILE AT THE MICHIGAN DEPARTMENT OF TRANSPORTATION.

- PLASTIC DRUM
- ▲▲▲ PROPOSED TYPE III BARRICADE
- △△△ EXISTING TYPE III BARRICADE

SYMBOLS TO BE USED ON PLANS

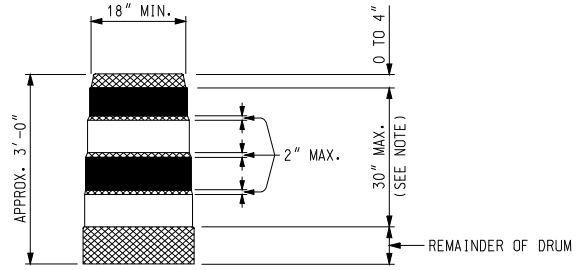

- REFLECTORIZED ORANGE
- REFLECTORIZED WHITE
- NON REFLECTORIZED ORANGE

NOTE:
 DRUMS SHALL HAVE AT LEAST 4 HORIZONTAL REFLECTORIZED STRIPES (2 ORANGE AND 2 WHITE) OF 6" UNIFORM WIDTH, ALTERNATING IN COLOR WITH THE TOPMOST REFLECTORIZED STRIPE BEING ORANGE. NON REFLECTORIZED SPACES BETWEEN THE HORIZONTAL REFLECTORIZED ORANGE AND WHITE STRIPES SHALL BE ORANGE IN COLOR AND EQUAL IN WIDTH.

PLASTIC DRUM

NOTES:

2" PERFORATED SQUARE STEEL TUBES MAY BE USED TO FABRICATE THE HORIZONTAL BASE OF THE TYPE III BARRICADE.

WARNING LIGHTS SHALL BE PLACED ACCORDING TO THE CURRENT STANDARD SPECIFICATIONS FOR CONSTRUCTION AND ALL OTHER PROVISIONS IN THE CONTRACT WHEN THEY ARE USED ON TYPE III BARRICADES.

SEE ROAD STANDARD PLANS R-113-SERIES FOR TEMPORARY CROSSOVERS FOR DIVIDED ROADWAY, AND R-126-SERIES FOR TYPICAL LOCATION AND SPACING OF PLASTIC DRUMS FOR PLACEMENT OF TEMPORARY CONCRETE BARRIER.

SIGNS, BARRICADES, AND PLASTIC DRUMS SHALL BE FACED WITH PRESSURE-SENSITIVE REFLECTIVE SHEETING ACCORDING TO THE CURRENT STANDARD SPECIFICATIONS FOR CONSTRUCTION.

SANDBAGS SHALL BE USED WHEN SUPPLEMENTAL WEIGHTS ARE REQUIRED TO ACHIEVE STABILITY OF THE BARRICADE. THE SANDBAGS SHALL BE PLACED SO THEY WILL NOT COVER OR OBSTRUCT ANY REFLECTIVE PORTION OF THE TRAFFIC CONTROL DEVICE.

NOT TO SCALE

MICHIGAN DEPARTMENT OF TRANSPORTATION BUREAU OF HIGHWAYS DELIVERY STANDARD PLAN	(SPECIAL DETAIL) FHWA APPROVAL DATE	9/22/09	WZD-125-E	SHEET 3 of 3
File: T&S/Typ/Signs/WorkZones/wzd 125 d	Rev. 09/22/09 PJ	PLAN DATE		

NOTE: THE ORIGINAL SIGNED COPY IS KEPT ON FILE AT THE MICHIGAN DEPARTMENT OF TRANSPORTATION.

DETAILED SPECIFICATIONS

1 of 3

Formatted: Different first page header

1. DISPOSING OF EXCAVATED MATERIAL

The Contractor shall dispose of, at the Contractor's expense, all excavated material. Costs for this work will not be paid for separately, but shall be included in the bid price of the associated item of work.

2. PROTECTION OF UTILITIES

Damages to utilities by the Contractor's operations shall be repaired by the utility owner at the Contractor's expense. Delays to the work due to utility repairs are the sole responsibility of the Contractor.

The Contractor shall keep construction debris out of utilities at all times. The Contractor shall be back charged an amount of \$50.00 per day for each manhole/inlet/utility pipe that contains construction debris caused as a result of the Contractor's (including subcontractors and suppliers) work.

The Contractor is solely responsible for any damages to the utilities or abutting properties due to construction debris.

Certain sanitary and storm sewers within the influence of construction may have been cleaned and videotaped prior to construction. The City may also choose to videotape utility line(s) during or after the work of this Contract to inspect them for damages and/or construction debris. If such inspection shows damage and/or debris, then all costs of such inspection, cleaning, repairs, etc, shall be the Contractor's sole responsibility. If such inspection is negative, the City will be responsible for the costs of such inspection.

Costs for this work will not be paid for separately, but shall be included in the bid price of the Contract Item "General Conditions."

3. SOIL EROSION CONTROL

The Contractor shall furnish, place, maintain and remove soil erosion and sedimentation control measures, including but not limited to, fabric filters at all drainage structures, all in accordance with all applicable City (and other governmental agencies) codes and standards, as directed by the Engineer, as detailed in the Standard Specifications, and as shown on the Plans.

The Contractor will be required to obtain and follow all requirements of a City of Ann Arbor Soil Erosion & Sedimentation Control permit.

4. VACUUM TYPE STREET AND UTILITY STRUCTURE CLEANING EQUIPMENT

The Contractor shall furnish and operate throughout the construction period, vacuum type street cleaning and utility structure cleaning equipment (Vac-All, Vactor, etc.) approved by the Engineer, as and when directed by the Engineer for dust control, for dirt/debris control, and for street cleaning immediately prior to, and for street and utility structure cleaning after any and all paving. The cleaning equipment shall be of sufficient power to remove dust, dirt, and debris from the pavement and from utility structures in and adjacent to the construction area.

Costs for this work will not be paid for separately, but shall be included in the bid price of the Contract Item "General Conditions."

5. SITE CLEAN UP

Immediately after completion of construction on each street, the Contractor shall clean the entire area within the influence of construction, including but not limited to all pavement, sidewalks, lawn areas, and

underground utility structures, of all materials which may have accumulated prior to or during the construction.

Costs for this work will not be paid for separately, but shall be included in the bid price of the Contract Item "General Conditions."

6. MATERIALS AND SUPPLIES CERTIFICATIONS

The following materials and supplies shall be certified by the manufacturer or supplier as having been tested for compliance with the Specifications:

- HMA materials
- Hot-poured Joint Sealants
- Cements, coatings, admixtures and curing materials
- Sands and Aggregates
- Steel and Fabricated metal
- Portland Cement Concrete Mixtures
- Reinforcing Steel for Concrete
- Reinforcing Fibers for Concrete
- Pre-cast Concrete products
- Sanitary Sewer Pipe
- Storm Sewer Pipe
- Water Main Pipe
- Corrugated Metal Pipe
- High Density Polyethylene Pipe
- Timber for retaining walls
- Modular Concrete Block for retaining walls
- Edge Drain and Underdrain Pipe
- Geotextile Filter Fabric and Stabilization Fabric/Grids

The Contractor shall submit all certifications to the Engineer for review and approval a minimum of three business days prior to any scheduled delivery, installation, and/or construction of same.

Costs for this work will not be paid for separately, but shall be included in the bid price of the associated item of work.

7. CONTRACT DRAWINGS/PLANS

The Contractor shall carefully check and review all Drawings/Plans and advise the Engineer of any errors or omissions discovered. The Drawings/Plans may be supplemented by such additional Drawings/Plans and sketches as may be necessary or desirable as the work progresses. The Contractor shall perform all work shown on any additional or supplemental Drawings/Plans issued by the Engineer.

8. SOIL BORING AND PAVEMENT SECTION DATA

Data pertaining to existing soil borings and pavement sections which may be included in these Contract Documents are provided to help the Engineer and Contractor determine the soil conditions existing within the construction area. The City in no way guarantees existing conditions to be the same as shown in the data. The Contractor is solely responsible for any and all conclusions he/she may draw from the data.

9. WORKING IN THE RAIN

The Contractor shall not work in the rain unless authorized in writing by the Engineer.

The Engineer may delay or stop the work due to threatening weather conditions.

The Contractor shall not be compensated for unused materials or downtime due to rain, or the threat of rain.

The Contractor is solely responsible for repairing all damages to the work and to the site, including road infrastructures, road subgrades, and any adjacent properties, which are caused as a result of working in the rain.

10. WORKING IN THE DARK

The Contractor shall not work in the dark except as approved by the Engineer and only when lighting for night work is provided as detailed elsewhere in this contract.

The Engineer may stop the work, or may require the Contractor to defer certain work to another day, if, in the Engineer's opinion, the work cannot be completed within the remaining daylight hours, or if inadequate daylight is present to either properly perform or inspect the work.

The Contractor will not be compensated for unused materials or downtime, when delays or work stoppages are directed by the Engineer for darkness and/or inadequate remaining daylight reasons.

The Contractor is solely responsible for repairing all damages to the work and to the site, including road infrastructures, road subgrades, and any adjacent properties, which are caused as a result of working in the dark.

11. QUANTITIES AND UNIT PRICES

Quantities as given are approximate and are estimated for bidding purposes. Quantities are not guaranteed and may vary by any amount. While it is the City's intent to complete the project substantially as drawn and specified herein, quantities may be changed or reduced to zero for cost savings or other reasons. **The City reserves the right to change the quantities, delete streets, or add streets, and no adjustment in unit price will be made for any change in any quantity.**

CITY OF ANN ARBOR

NOTICE TO BIDDERS

AA:DAD

1 of 2

04/05/15

Utilities Coordination

The Contractor shall cooperate and coordinate construction activities with the owners of utilities as stated in subsection 104.08 of the Standard Specifications for Construction. In addition, for the protection of underground utilities, the Contractor shall follow the requirements in subsection 107.12 of the Standard Specifications for Construction. Contractor delay claims resulting from a utility will be determined based upon subsection 108.09 of the Standard Specifications for Construction.

The following Utility Owners have facilities located within the Right-of-Way:

<u>Utility</u>	<u>Type of Service</u>
City of Ann Arbor W.R. Wheeler Service Center 4251 Stone School Road Ann Arbor, MI 48108 734 794-6351	Sanitary Sewer (Mark Cozart - ext. 43318) Water (Daniel Wooden - ext. 43324) Storm Sewer (Kevin Ernst - ext. 43327) Communications/Signs/Signals/Street Lighting (Chuck Fojtik - ext. 43322)
AT&T 550 South Maple Ann Arbor, MI 48103 Attn: Debora Renner 734-996-5485 debora.a.renner@att.com	Telephone/Fiber Optic
Comcast 27800 Franklin Road Southfield, MI 48034 Attn: Ron Southerland 248-359-6544 ronald_southerland@cable.comcast.com	Cable/Fiber Optic
DTE Energy 2000 2 nd Ave, Room 518 S.B. Detroit, MI 48226 Attn: Julie Gottardi 734-884-0585 gottardij@dteenergy.com	Electric
DTE Energy (Michcon) 17150 Allen Road Melvindale, MI 48122 Attn: Laurie Forrester 313-389-7261 forresterl@dteentergy.com	Gas

CITY OF ANN ARBOR

NOTICE TO BIDDERS

AA:DAD

2 of 2

04/05/15

MCI/Verizon
5688 W Grand River Avenue
Lansing, MI 48906
Attn: Rick Chalmers
517-318-8064
rick.chalmers@verizonbusiness.com

Telephone/Fiber Optic

For protection of underground utilities, the Contractor shall call "MISS DIG" toll free at 1-800-482-7171 or call 811 a minimum of three (3) working days prior to excavation within the project limits. The Contractor must also notify utility owners who may not be part of the "MISS DIG" system.

The Contractor shall notify the City of Ann Arbor a minimum of three (3) days prior to beginning construction.

The Owners of public or private utilities which will not interfere with the completed project and which do not present a hazard to the public or an extraordinary hazard to the Contractor's operations will not be required to move their facilities on or from the street right-of-way.

The Contractor shall verify the location and depth of all utilities through Miss Dig and coordinate with the utilities to ensure that all utilities are protected during the project.

Protection of existing utility facilities is necessary during the project. Protection may include: holding utility poles, supporting underground facilities, temporary sheeting, bracing, poles, cables, sand fill or other means to complete the work. The Contractor is responsible for furnishing all labor, equipment and materials required to protect existing facilities during construction. Costs associated with protecting existing utilities will not be paid for separately.

**DETAILED SPECIFICATION
FOR
GENERAL CONDITIONS, MAX \$**

1 of 2

DESCRIPTION

This item shall include all work described and required by the Plans and Specifications for which no item of work is listed in the Bid Form, including but not limited to:

- Scheduling and organization of all work, subcontractors, suppliers, testing, inspection, surveying, and staking
- Coordination of, and cooperation with, other contractors, agencies, departments, and utilities
- Protection and maintenance of Utilities
- Maintaining drainage
- Maintaining drives, drive openings, sidewalks, bikepaths, mail deliveries, and solid waste/recycle pick-ups, including moving bins as necessary
- Storing all materials and equipment off lawn areas
- Temporary relocation and final replacement/re-setting of mailboxes
- Coordination efforts to furnish various HMA mixtures as directed by the Engineer
- Coordination efforts to furnish and operate various-size vehicles/equipment as directed by the Engineer
- Furnishing and operating vacuum-type street cleaning equipment a minimum of once per week or more frequently as directed by Engineer
- Furnishing and operating vacuum-type utility structure cleaning equipment as directed by Engineer
- Furnishing and operating both vibratory plate and pneumatic-type ("pogo-stick") compactors
- Furnishing and operating a backhoe during all work activities
- Furnishing and operating a jackhammer and air compressor during all work activities
- Noise and dust control
- Mobilization(s) and demobilization(s)
- Furnishing submittals and certifications for materials and supplies
- Disposing of excavated materials and debris
- All miscellaneous and incidental items such as overhead, insurance, and permits.

At various times throughout the work, the Engineer may direct the Contractor to use smaller and/or lighter equipment, and to defer certain work tasks, in order to protect the grade and/or adjacent areas. The Contractor shall not be entitled to any additional compensation for the use of smaller equipment, lighter equipment, or work task deferral.

MEASUREMENT AND PAYMENT

This item of work will be paid for on a pro rata basis at the time of each progress payment. Measurement will be based on the ratio between work completed during the payment period and the total contract amount. When all of the work of this Contract has been completed, the measurement of this item shall be 1.0 Lump Sum.

The completed work as measured for this item of work will be paid for at the Contract Unit Price for the following Contract (Pay) Item:

**DETAILED SPECIFICATION
FOR
GENERAL CONDITIONS, MAX \$**

2 of 2

PAY ITEM

General Conditions, Max \$

PAY UNIT

Lump Sum

The unit price for this item of work shall include all labor, material, and equipment costs to perform all the work specified in the Standard Specifications and as modified by this Detailed Specification.

**DETAILED SPECIFICATION
FOR
PROJECT SUPERVISION, MAX \$**

1 of 3

DESCRIPTION

The Contractor shall designate a full-time Project Supervisor to act as the Contractor's agent/representative, and to be responsible for scheduling and coordination of all subcontractors, suppliers, other governmental agencies, and all public and private utility companies.

The Project Supervisor shall not be an active crew member of the Contractor, shall not be an active member or employee of any subcontractor's work force, and shall not perform general or specialized labor tasks.

The Project Supervisor shall work exclusively on this project, and shall put forth his/her full effort into the organization and coordination of the work of this project.

Prior to the pre-construction meeting, the Contractor shall designate a proposed Project Supervisor by name, and shall furnish the City with a current, thorough, detailed summary of the proposed Project Supervisor's work history, outlining all previous supervisory experience on projects of a similar size and nature. The detailed work history shall include personal and professional references (names and phone numbers) of persons (previous owners or agents) who can attest to the qualifications and work history of the proposed Project Supervisor. Proposed candidates for Project Supervisor shall have a demonstrated ability to work harmoniously with the City, the public, subcontractors, and all other parties typically involved with work of this nature. The Supervising Professional will have the authority to reject a proposed Project Supervisor whom he/she considers unqualified.

The Project Supervisor shall be available 24 hours-per-day to provide proper supervision, coordination and scheduling of the project for the duration of the Contract. The Contractor shall furnish the City with telephone numbers of the Project Supervisor in order to provide 24 hour-per-day access during business and non-business hours, including weekends and holidays. While work is ongoing, the Project Supervisor or approved designee must be on site at all times.

The Project Supervisor shall be equipped by the Contractor with a mobile telephone to provide the City with 24 hour-per-day access to him/her during daily construction activities, during transit to and from the construction site, and during all non-business hours including weekends and holidays.

The Project Supervisor shall be equipped with assistants as necessary to provide project supervision as specified herein, and in accordance with the Contract.

DUTIES AND RESPONSIBILITIES

The Project Supervisor work harmoniously with the City, the public, subcontractors, and all other parties typically involved with work of this nature.

The Project Supervisor is responsible to notify and coordinate access to affected properties. This includes notifying and coordinating mail delivery and garbage pick-up and notifying businesses and residents at least 48 hours prior to restricting access to their street and property.

The Project Supervisor shall have a thorough, detailed understanding and working knowledge of all construction practices and methods specified elsewhere herein, as well as the handling, placement,

**DETAILED SPECIFICATION
FOR
PROJECT SUPERVISION, MAX \$**

2 of 3

testing and inspection of aggregates, aggregate products, HMA concrete, and portland cement concrete materials.

The Project Supervisor shall be responsible for all of the work of all of the Contractor's, subcontractors' and suppliers' work forces.

The Project Supervisor shall be responsible for proper and adequate maintenance (emissions, safety, and general operation) of all of the Contractor's, subcontractors' and suppliers' equipment and vehicles.

The Project Supervisor shall be responsible for the legal, proper and safe parking/storage of all of the Contractor's, subcontractors' and suppliers' equipment, work vehicles, and employee's vehicles.

The Project Supervisor shall schedule and coordinate the work of all parties involved in the project, including utility companies, testing agencies, governmental agencies, all City departments (such as Utilities and Transportation), and City inspectors.

The Project Supervisor shall coordinate with both Testing inspectors and City inspectors in a timely manner, to assure proper and timely testing and inspection of the work.

The Project Supervisor shall review the Inspector's Daily Reports (IDRs) for agreement, and shall sign all IDRs on a daily basis as the representative of the Contractor. Items to be reviewed include descriptions, locations and measurements of quantities of work performed, workforce, equipment, and weather. The Project Supervisor shall also be responsible for its subcontractors' review and initialing of IDRs containing work items performed by each respective subcontractors.

The Project Supervisor shall submit to the Engineer, an updated, detailed schedule of the proposed work on a weekly basis, and an update of all proposed changes on a daily basis, all in accordance with the Detailed Specification for Project Schedule contained elsewhere herein.

The Project Supervisor shall schedule and chair a weekly progress meeting with the Engineer and all subcontractors to discuss the work. Upon the completion of each meeting, the Project Supervisor shall prepare and distribute, to all present, a written summary of the meeting's minutes. Those in attendance shall review the minutes and, if necessary, comment on any deficiencies or errors prior to or at the next scheduled progress meeting.

ADDITIONAL PERFORMANCE REQUIREMENTS

If, in the sole opinion of the Supervising Professional, the Project Supervisor is not adequately performing the duties as outlined in this Detailed Specification, the following system of notices will be given to the contractor with the associated penalties:

First Notice – A warning will be issued in writing to the contractor detailing the deficiencies in the Project Supervision. The contractor must respond within 7 calendar days in writing with a plan to correct the stated deficiencies. Failure to respond within 7 calendar days will result in the issuing of a second notice.

**DETAILED SPECIFICATION
FOR
PROJECT SUPERVISION, MAX \$**

3 of 3

Second Notice – A second warning will be issued in writing to the contractor further detailing the deficiencies in the Project Supervision. The contractor must respond within 7 calendar days in writing with a plan to correct the stated deficiencies. Failure to respond within 7 calendar days will result in the issuing of a third notice. A deduction of 10% will be made from the original Project Supervision contract amount. At this time, the City reserves the right to meet with personnel with the necessary authority within the Contractor's organization to discuss the deficiencies in the Project Supervision.

Third Notice – An additional deduction of 25% will be made from the original Project Supervision contract amount, and the Project Supervisor shall be removed from the project, and replaced immediately with another individual to be approved by the Supervising Professional.

Should, in the sole opinion of the Supervising Professional, the Project Supervisor fail to perform his/her duties and responsibilities as described herein to such a degree that the successful completion of the project is put in jeopardy, the above system of notices may be foregone, and the Contractor shall immediately replace the Project Supervisor upon receipt of written notice. Failure to provide adequate project supervision, as determined by the Engineer, shall be considered basis for the Supervising Professional to suspend work without extension of contract time or additional compensation.

MEASUREMENT AND PAYMENT

This item of work will be paid for on a pro rata basis at the time of each progress payment. Measurement will be based on the ratio between work completed during the payment period and the total contract amount. When all of the work of this Contract has been completed, the measurement of this item shall be 1.0 Lump Sum, minus any deductions incurred for inadequate performance as described herein. This amount will not be increased for any reason, including extensions of time, extras, and/or additional work.

The completed work as measured for this item of work will be paid for at the Contract Unit Price for the following Contract (Pay) Item:

PAY ITEM

Project Supervision, Max \$

PAY UNIT

Lump Sum

The unit price for this item of work shall include all labor, material, and equipment costs to perform all the work specified in the Standard Specifications and as modified by this Detailed Specification.

CITY OF ANN ARBOR
DETAILED SPECIFICATION
FOR
AUDIOVISUAL TAPE COVERAGE

AA:DAD

1 of 4

04/08/15

a. Description. This work shall include providing a recording of the physical, structural, and aesthetic conditions of the construction site and adjacent areas as provided herein.

The audiovisual recording shall be:

1. Of professional quality, providing a clear and accurate audio and visual record of existing conditions.
2. Prepared during the period prior to bringing any materials or equipment within the areas described in this special provision.
3. Carried-out under the supervision of the Engineer.

The Contractor shall furnish two (2) copies of the completed recording to the Engineer at the preconstruction meeting, or five (5) business days prior to commencing with construction. An index of the recording, which will enable any area of the project to be easily found on the recording, shall be included. The Contractor shall retain a third copy of the recording for its own use.

Any portion of the recording determined by the Engineer to be unacceptable for the documentation of existing conditions shall be recorded again, at the Contractor's sole expense, and submitted to the Engineer prior to mobilizing onto the site.

b. Materials. The audiovisual recording shall be provided using digital video disk (DVD) media, or other media approved by the Engineer.

c. Construction. Complete audio-visual recording work in accordance with the requirements shown below.

1. Production:
 - A. DVD Format / No Editing. The audio-visual recording shall be performed using equipment that allows audio and visual information to be recorded simultaneously and in color. The recording shall be provided on compact discs in DVD format. The quality of the recording shall be equal to or better than the standard in the industry. The recording shall not be edited.
 - B. Perspective / Speed / Pan / Zoom. To ensure proper perspective, the distance from the ground to the camera lens shall not be less than 12 feet and the recording must proceed in the general direction of travel at a speed not to exceed 48 feet per minute (0.55 miles per hour). Pan and zoom rates shall be controlled sufficiently so that playback will ensure quality of the object viewed.
 - C. Display. The recording equipment shall have transparent time, date stamp and digital annotation capabilities. The final copies of the recording shall continuously

CITY OF ANN ARBOR
DETAILED SPECIFICATION
FOR
AUDIOVISUAL TAPE COVERAGE

AA:DAD

2 of 4

04/08/15

and simultaneously display the time (hours:minutes:seconds) and the date (month/date/year) in the upper left-hand corner of the frame. Accurate project stationing shall be included in the lower half of the frame in standard station format (i.e. 1+00). Below the stationing periodic information is to be shown, including project name, name of area shown, direction of travel, viewing direction, etc.

D. On streets or in areas where there is no project stationing, assumed stationing shall be used, starting with 0+00 and progressing from west to east or from north to south.

E. Audio Commentary / Visual Features. Locations relative to project limits and landmarks must be identified by both audio and video means at intervals no longer than 100 feet along the recording route. Additional audio commentary shall be provided as necessary during the recording to describe streets, buildings, landmarks, and other details, which will enhance the record of existing conditions.

F. Visibility / Ground Cover. The recording shall be performed during a time of good visibility. The recording shall not be performed during periods of precipitation or when snow, leaves, or other natural debris obstruct the area being recorded.

2. Coverage. The audio-visual recording coverage shall include the following:

A. General Criteria. These general criteria shall apply to all recording and shall include all areas where construction activities will take place or where construction vehicles or equipment will be operated or parked and/or where materials will be stored or through which they will be transported. The recording shall extend an additional 50 feet outside of all areas. The recording shall include all significant, existing man-made and natural features such as driveways, sidewalks, utility covers, utility markers, utility poles, other utility features, traffic signal structures and features, public signs, private signs, fences, landscaping, trees, shrubs, other vegetation, and other similar or significant features.

B. Private Property. Record all private property that may be utilized by the Contractor in conjunction with this project. These project areas must be disclosed by the Contractor prior to using them for the work of this project.

C. Road Construction Area. The recording coverage shall:

- (1) Extend to 50 feet outside of the right-of-way and easements area as shown on the plans.
- (2) Extend 50 feet outside the construction limits on all streets, including side streets.
- (3) Both sides of each street shall be recorded separately.

CITY OF ANN ARBOR
DETAILED SPECIFICATION
FOR
AUDIOVISUAL TAPE COVERAGE

AA:DAD

3 of 4

04/08/15

D. Detour Route / Maintenance of Traffic Areas. The entire detour route and maintenance of traffic areas shall be recorded as indicated in this special provision except as follows:

- (1) The recording must proceed in the general direction of travel at a speed not exceeding 176 feet per minute (2 miles per hour).
- (2) The coverage area shall include the street and not go beyond the curb except in areas where there is a fair possibility that the detoured traffic will drive over the curb, such as at intersections.
- (3) The recording shall focus in particular at sidewalk ramps and other features likely to have been damaged or likely to be damaged as a result of existing traffic, temporary detoured traffic and or construction traffic. In these areas, recording may need to proceed much more slowly.

Only the side of street with the detoured traffic must be recorded. However, the Contractor is advised that portions of the detour routes may operate in opposite directions at different times. In these cases, both sides of the street shall be recorded separately.

E. Private Property Bordering the Project Limits or Work Areas. Record all areas bordering the project where work is scheduled to occur or where construction traffic could damage the private property. This is to including buildings, driveways, decks, landscaping, trees, and all other similar features.

F. Other Areas. The Contractor shall record at his sole expense other areas where, in his/her opinion, the establishment of a record of existing conditions is warranted. The Contractor shall notify the Engineer in writing of such areas.

The Engineer may direct the recording of other minor areas not specified above at the Contractor's sole expense.

3. Audio-Visual Recording Services. The following companies are known to be capable of providing the recording services required by this special provision and shall be utilized, unless the Contractor receives prior written approval from the Engineer to utilize another company of comparable or superior qualifications.

- Construction Video Media
- Midwest Company
- Topo Video, Inc.
- Video Media Corp.
- Paradigm 2000, Inc.
- Finishing Touch Photo and Video

CITY OF ANN ARBOR
DETAILED SPECIFICATION
FOR
AUDIOVISUAL TAPE COVERAGE

AA:DAD

4 of 4

04/08/15

c. Measurement and Payment. The completed work, as described, will be measured and paid for at the contract unit price for the following pay item:

<u>Pay Item</u>	<u>Pay Unit</u>
Audiovisual Tape Coverage.....	Lump Sum

Audiovisual Tape Coverage shall include all labor, equipment, and materials required to perform the recording and to provide the finished recording the Engineer.

Payment will be made for **Audiovisual Tape Coverage** following the review and acceptance of the recording by the Engineer. Within twenty-one (21) days following the receipt of the recording, the Engineer will either accept it and authorize payment or require that any discrepancies in the recording be addressed prior to making payment.

**DETAILED SPECIFICATION
FOR
STORM SEWER AND STRUCTURE REMOVAL**

DESCRIPTION

This work shall consist of removing storm sewer and drainage structures in accordance with section 203 of the 2012 MDOT Standard Specifications for Construction, and as modified herein.

MATERIALS

Backfill shall consist of Sound Earth or Granular Material Class II in accordance with sections 205 and 902, respectively, of the 2012 MDOT Standard Specifications for Construction.

CONSTRUCTION METHODS

Remove storm sewer to the limits shown on the plans. Bulkhead pipe end or structure opening, as shown on the plans or as directed by the Engineer.

Remove drainage structures as noted on the plans or as directed by the Engineer.

All castings shall be salvaged and delivered to the City Utilities Department yard at 4251 Stone School Road (Wheeler Center).

MEASUREMENT AND PAYMENT

The completed work as measured for these items of work will be paid for at the Contract Unit Price for the following Contract (Pay) Items:

PAY ITEM

Storm Sewer Pipe Remove
Storm Sewer Structure Remove

PAY UNIT

Lineal Foot
Each

The unit prices for these items of work shall include all labor, material, and equipment costs to perform all the work specified in the Standard Specifications and as modified by this Detailed Specification.

Disposal of sewer and structures removed and any excavated material that is not deemed suitable Sound Earth for backfill shall be considered included in the unit price of the applicable item.

Additional Granular Material Class II required for backfill shall be included in the unit price of the applicable item.

Delivery of the salvaged castings shall be included in the unit price for Storm Sewer Structure Remove.

**DETAILED SPECIFICATION
FOR
REMOVE AND REPLACE BRICK PAVERS, ANY TYPE**

1 of 2

DESCRIPTION

This work shall consist of removing, stockpiling and reinstalling sidewalk pavers, furnishing and installing sand base, concrete base, fine aggregate leveling bed, fine aggregate joint filler, and any additional brick pavers as shown on the Plans, as shown in this Detailed Specification, and as directed by the Engineer.

MATERIALS

Aggregate base, where required, shall consist of MDOT 21AA Limestone in accordance with Section 902 of the 2012 MDOT Standard Specifications for Construction.

Sand base, where required, shall consist of Class II granular material in accordance with Section 902 of the 2012 MDOT Standard Specifications for Construction.

Concrete base, where required, shall be constructed of Class A Portland cement concrete.

Fine aggregate leveling bed shall consist of a 3:1 mix of MDOT 2NS (3 parts) and Type N mortar (1 part). Fine aggregate joint filler shall consist of MDOT 2MS.

Any additional brick pavers required shall match the existing brick in the areas adjoining the removal/replacement limits.

CONSTRUCTION METHODS

The Contractor shall remove and salvage existing pavers, remove any existing mortar or bituminous setting bed and concrete base, to the limits specified by the Engineer, down to the existing aggregate base. Where an existing base is not present, the subbase shall be removed to a sufficient depth for construction of the proposed section as shown on the attached detail, or as directed by the Engineer. Salvaged pavers shall be stored on-site in an area approved by the Engineer until they are ready to be replaced.

The Contractor shall reshape, regrade, and recompact the existing base materials, and shall construct the base to match the existing adjacent elevations.

Fine aggregate and mortar shall be uniformly blended to create the leveling bed mix. Leveling bed is to be placed on aggregate base or existing concrete base to the depth shown on the Plans. Control bars and/or guides shall be used to screed the fine aggregate leveling bed.

Brick installation is to match the pattern of the existing adjacent brickwork. String lines or other devices are to be used as needed to insure straight joint lines and final surface elevations. Paving units are to be butted tight to adjacent concrete paving and to each other. Newly laid pavers are to be protected at all times by plywood panels on which workers stand. A minimum of three (3) passes of a plate vibrator (min. 5,000 lbs compaction force) shall be made to set paving units in leveling course prior to filling joints. Pavers should be protected from chipping and cracking during compaction.

Fine aggregate joint filler shall be spread over paver surface and broomed into joints, and misted lightly with water to settle sand into joints. Allow to surface dry and repeat process until joints are filled completely. Remove excess sand upon completion.

**DETAILED SPECIFICATION
FOR
REMOVE AND REPLACE BRICK PAVERS, ANY TYPE**

2 of 2

The Contractor shall take any necessary precautions to prevent damage to pavers during removal and replacement. The Contractor is not entitled to any additional compensation for such replacement of damaged pavers.

MEASUREMENT AND PAYMENT

Completed work as measured for this item of work will be paid for at Contract Unit Price for the following Contract Pay Item:

<u>PAY ITEM</u>	<u>PAY UNIT</u>
Remove and Replace Brick Pavers, Any Type	Square Foot

The unit price for this item of work shall include all labor, material, and equipment costs to perform all the work specified in the Standard Specifications and as modified by this Detailed Specification.

CITY OF ANN ARBOR
DETAILED SPECIFICATION
FOR
REMOVING CONCRETE ITEMS

AA:DAD

1 of 2

04/08/15

a. Description. This work shall consist of removing concrete curb, gutter, curb and gutter, integral curb, sidewalk, sidewalk ramps, pavement, drive openings, and drive approach pavements as shown on the plans, in accordance with section 204 2012 MDOT Standard Specifications for Construction, except as specified herein, and as directed by the Engineer.

b. Materials.

c. Construction. Construction methods shall be as described in section 204 of the MDOT 2012 Standard Specifications for Construction, as described below, and as directed by the Engineer.

Curb, gutter, curb and gutter, sidewalk, sidewalk ramps, drive openings, and drives shall be replaced within 24 hours of their removal.

Prior to the start of work, the Engineer and Contractor together shall identify and field measure all items to be removed. The Engineer shall approve of all removal limits prior to any removals being performed by the Contractor.

The Contractor shall perform full-depth saw cutting at removal limits, including those necessary to construct 2-foot wide MDOT Type M drive openings, as shown on the Plans, as directed by the Engineer, and as marked for removal.

The Contractor shall cut steel reinforcement bars as directed by the Engineer at all areas of removal.

All saw cutting shall be performed under wet conditions to prevent excessive airborne dust. All resulting slurry and debris shall be cleaned up the satisfaction of the Engineer.

The Contractor shall coordinate with the City Forester prior to the removal of any tree roots.

Excavated/removal areas shall be adequately protected with barricades and/or fencing at all times.

Removed or excavated materials which are not incorporated into the work shall become the property of the Contractor and shall be immediately removed and properly disposed of off-site. Removed or excavated materials may not be stockpiled overnight on, or adjacent to, the site.

Base, subbase, or subgrade materials removed without authorization by the Engineer shall be replaced and compacted by the Contractor at the Contractor's expense, with materials specified by the Engineer.

d. Measurement and Payment. The completed work, as described, will be measured and paid for at the respective contract unit prices for the following respective pay items:

Pay Item

Pay Unit

Remove Concrete Pavement - Any Thickness.....	Square Yard
Remove Concrete Curb and Gutter - Any Type	Lineal Foot
Remove Concrete Sidewalk - Any Thickness	Square Foot
Remove Concrete Driveways - Any Thickness	Square Foot

Basis of payment shall be as described in subsection 205.04 of the Standard Specifications for Construction.

All sawcutting required for removals shall be included in the appropriate item of work, and will not be paid for separately. Payment for saw cutting to create or modify Type M openings and to allow for the partial removal of existing drives shall be included in the price of the item of work, "Remove Concrete Curb and Gutter - Any Type".

**DETAILED SPECIFICATION
FOR
REMOVE HMA SURFACE**

DESCRIPTION

This work shall consist of removing an HMA surface from an underlying pavement as described in Section 501 of the 2012 edition of the MDOT Standard Specifications for Construction, except as modified herein, and as directed by the Engineer.

CONSTRUCTION METHOD

The Contractor shall remove an HMA surface of any thickness from an aggregate base or concrete base course, with or without the removal of the aggregate or concrete base, all as shown on the Plans, as marked in the field, and as directed by the Engineer.

The Contractor shall remove and properly dispose of all excavated material and debris. The Contractor shall not stockpile excavated material overnight on, or adjacent to, the site.

HMA pavements shall be cut for removal by the use of saws or other methods approved by the Engineer. The edges of patches shall be cut horizontally and vertically straight and uniform, as judged by the Engineer, without damaging adjacent pavement.

The Contractor shall remove pavement full depth utilizing a mill, regardless of thickness.

Damage to adjacent pavement, pavement base, subbase, curb, gutter, sidewalk, utility structures, or other site features, due to removal operations shall be repaired by the Contractor, at the Contractor's expense, as directed by the Engineer.

The Contractor shall construct butt-joints, and trim butt-joints just prior to HMA paving as shown on the Plans, and as directed by the Engineer. Construction of butt joints, where directed by the Engineer, shall be measured and paid for as "HMA Surface, Rem."

MEASUREMENT AND PAYMENT

The areas to be removed shall be marked and measured prior to the removal of any material. Both parties shall come to an agreement regarding removal quantities prior to the actual removal of HMA pavement.

Where underlying pavement of concrete or brick is to be removed, payment will be paid separately.

The completed work as measured for these items of work will be paid at the Contract Unit Prices for the following Contract (Pay) Item:

PAY ITEM

HMA Surface, Rem

PAY UNIT

Square Yard

The unit prices for these items of work shall include all labor, material, and equipment costs to perform all the work specified in the Standard Specifications and as modified by this Detailed Specification.

CITY OF ANN ARBOR
SPECIAL PROVISION
FOR
SOIL EROSION AND SEDIMENTATION CONTROL – INLET PROTECTION

AA:DAD

1 of 1

04/05/15

a. Description. This work consists of installing and maintaining inlet filters, as shown on the plans, in accordance with Section 208 of the Michigan Department of Transportation (MDOT) 2012 Standard Specifications for Construction and. Filters shall be installed in existing and proposed inlets in order to minimize the erosion of soil and the sedimentation of water courses. The related work includes the installation, maintenance and removal of the filter cloth, cleaning as required during the performance of the project work, removing and disposing of accumulated sediment, and replacement of filters if required by the Engineer so as to provide a properly working inlet filter and a well-drained site.

b. Materials. The inlet filters shall be in accordance with the REGULAR FLOW SILTSACK® manufactured by ACF Environmental (800) 448-3636; FLEXSTORM® Style FX manufactured by Advanced Drainage Systems, Inc. (800) 821-6710; CATCH-ALL® manufactured by Price & Company (866) 960-4300, or Engineer approved equal.

The Contractor shall submit product data sheets and a sample of the filter material for inlet filters for Engineer approval prior to ordering materials.

c. Methods of Construction. The Contractor shall install, maintain, clean, and re-install and/or replace inlet filters in accordance with the manufacturer's specifications and as directed by the Engineer. The Contractor shall dispose of debris off-site.

d. Measurement and Payment. The completed work, as described, will be measured and paid for at the contract unit price for the following pay item:

<u>Pay Item</u>	<u>Pay Unit</u>
Erosion Control Inlet Protection Fabric Drop	Each

Erosion Control Inlet Protection Fabric Drop will be measured by the unit installed and will be paid for at the contract unit price per each, for which price shall be payment in full for all labor, equipment, and materials needed to furnish, install, maintain, clean and remove the inlet filter, and re-install and/or replace the inlet filter as needed.

**DETAILED SPECIFICATION
FOR
SAND AND AGGREGATE BASE**

DESCRIPTION

All granular and dense graded aggregate used for subbase, base, and gravel shoulder construction shall be placed in accordance with Sections 301, 302 and 307 of the 2012 edition of the MDOT Standard Specifications for Construction.

MATERIAL

All aggregates shall be crushed limestone meeting the gradation of MDOT 21AA in accordance with Section 902 of the 2012 MDOT Standard Specifications for Construction.

All sand shall meet the gradation of MDOT Class II granular material in accordance with Section 902 of the 2012 MDOT Standard Specifications for Construction..

CONSTRUCTION

This work shall consist of constructing shoulders and a subbase or base course on an existing prepared grade in accordance with Sections 301, 302 and 307 of the 2012 edition of the MDOT Standard Specifications for Construction.

**DETAILED SPECIFICATION
FOR
STORM SEWER**

DESCRIPTION

This work shall consist of constructing storm sewer in accordance with section 402 of the 2012 MDOT Standard Specifications for Construction, and as modified herein.

MATERIALS

The sewer pipe shall meet the requirements of the City of Ann Arbor Standard Specifications.

Trench backfill shall be Class II sand in accordance with the Detailed Specification for Sand and Aggregate contained herein.

Connections between new and existing pipe and/or structures shall be by "Fernco" type joint fasteners/couplings, or other methods approved by the Engineer,

CONSTRUCTION METHODS

The Contractor shall install storm sewer in accordance with section 402 of the 2012 MDOT Standard Specifications for Construction, and per the appropriate Trench Detail contained within these Contract Documents.

The Contractor shall remove and properly dispose of all excavated materials, removed storm sewer and debris, and shall bulkhead or abandon existing pipe and structures, all as directed by the Engineer.

The Contractor shall maintain line and grade of the sewer by means of a laser. The Engineer will establish line and grade for the sewer construction and will provide cut sheets for the Contractor's use.

In areas where the road is to be reconstructed, the Contractor may elect to perform sewer work prior to the removal of pavement and subgrade preparation. In such cases, the work associated with pavement removal, excavation, backfill, and the temporary patching of the trench as necessary for traffic maintenance, will not be paid for separately, but shall be included in these items of work.

MEASUREMENT AND PAYMENT

Where the contractor elects to furnish and place flowable fill as backfill for these items, it will not be paid separately, but shall be included in the bid prices for these items of work.

The completed work as measured for these items of work will be paid for at the Contract Unit Price for the following Contract (Pay) Items:

PAY ITEM

Storm Sewer RCP ___inch SD-TR-I

PAY UNIT

Lineal Foot

The unit prices for these items of work shall include all labor, material, and equipment costs to perform all the work specified in the Standard Specifications and as modified by this Detailed Specification.

**DETAILED SPECIFICATION
FOR
SEWER BULKHEADS**

DESCRIPTION

This work shall consist of constructing sewer bulkheads in accordance with section 402 and 403 of the 2012 MDOT Standard Specifications for Construction, and as modified herein.

MATERIALS

Trench backfill shall be Class II sand in accordance with the Detailed Specification for Sand and Aggregate contained herein.

Concrete, Grade S3 shall be in accordance with section 701 of the 2012 MDOT Standard Specifications for Construction.

Mortar, Type R-2 shall be in accordance with section 702 of the 2012 MDOT Standard Specifications for Construction.

Brick and blocks shall be in accordance with section 913 of the 2012 MDOT Standard Specifications for Construction.

CONSTRUCTION METHODS

The Contractor shall remove and properly dispose of all excavated materials, removed storm sewer and debris, and shall bulkhead or abandon existing pipe and structures, all as directed by the Engineer.

MEASUREMENT AND PAYMENT

Where the contractor elects to furnish and place flowable fill as backfill for these items, it will not be paid separately, but shall be included in the bid prices for these items of work.

The completed work as measured for these items of work will be paid for at the Contract Unit Price for the following Contract (Pay) Items:

PAY ITEM

PAY UNIT

Sewer Bulkhead, 4-Inch Through 18-Inch Diameter

Each

The unit prices for these items of work shall include all labor, material, and equipment costs to perform all the work specified in the Standard Specifications and as modified by this Detailed Specification.

**DETAILED SPECIFICATION
FOR
FLOWABLE FILL**

DESCRIPTION

This work shall consist of furnishing and placing flowable fill as backfill material at miscellaneous locations as shown on the Plans, and as directed by the Engineer.

MATERIALS

Flowable fill shall meet the requirements of the City of Ann Arbor Standard Specifications.

CONSTRUCTION METHODS

The Contractor shall furnish and place flowable fill at miscellaneous locations as shown on the Plans and as directed by the Engineer.

MEASUREMENT AND PAYMENT

Flowable fill used at the Contractor's option will not be paid for separately, but shall be included either in the bid price(s) for the associated work item(s), or in the bid price for the item of work "General Conditions".

The completed work as measured for this item of work will be paid for at the Contract Unit Price for the following Contract (Pay) Item:

PAY ITEM

Flowable Fill

PAY UNIT

Cubic Yard

The unit price for this item of work shall include all labor, material, and equipment costs to perform all the work specified in the Standard Specifications and as modified by this Detailed Specification.

**DETAILED SPECIFICATION
FOR
DRAINAGE STRUCTURES**

1 of 2

DESCRIPTION

This work shall consist of constructing inlets, catch basins, manholes, and double inlet structures of portland cement concrete block masonry, or brick masonry. The work shall be performed in accordance with Section 403 of the 2012 edition of the MDOT Standard Specification for Construction, and as detailed on the Plans.

MATERIALS

The materials shall meet the requirements as referenced for this work in Section 403 of the 2012 edition of the MDOT Standard Specification for Construction.

Castings and/or covers shall be as specified in the Detailed Specification for Structure Covers, contained within these documents.

CONSTRUCTION METHODS

Construction shall be in accordance with Section 403 of the 2012 edition of the MDOT Standard Specification for Construction, the City Standard Specifications, this Detailed Specification, and the Plans, and, as directed by the Engineer.

2 foot deep sumps are to be constructed with single inlets, double inlets, and inlet junction chambers. Manholes are not to receive a sump.

Upon completing the installation of a drainage structure, the Contractor shall temporarily patch the curb adjacent to the drainage structure with either HMA or a cold patch bituminous mixture.

All structures, inlets, and manholes shall be maintained free of accumulations of silt, debris, and other foreign matter throughout construction, until the time of final acceptance.

MEASUREMENT AND PAYMENT

Payment for furnishing and installing storm sewer is not included in these items, but will be measured and paid for separately.

This work shall also include the furnishing, placement, and compaction of MDOT Class II sand backfill or flowable fill at removed structures and at connections between new structures and new and/or existing storm sewer leads. This work shall also include the proper disposal off-site of all excavated/removed materials and debris, and the salvaging and transporting of castings and/or covers to the City Field Operations Services Unit, all as directed by the Engineer.

Furnishing and placing flowable fill as backfill for this item will not be paid separately, but shall be included in the bid price for this item of work.

The completed work as measured for this item of work will be paid for at the Contract Unit Price for the following Contract (Pay) Item:

**DETAILED SPECIFICATION
FOR
DRAINAGE STRUCTURES**

2 of 2

PAY ITEM

Single Inlet
Double Inlet

PAY UNIT

Each
Each

The unit price for this item of work shall include all labor, material, and equipment costs to perform all the work specified in the Standard Specifications and as modified by this Detailed Specification.

Construction of a 2 foot deep sump is to be included in the cost of Single Inlet, Double Inlet, and Inlet-Junction Chamber.

**DETAILED SPECIFICATION
FOR
STRUCTURE COVERS**

1 of 1

DESCRIPTION

This work shall consist of replacing and furnishing structure covers and castings for structures, gate wells and inlet structures as shown on the Plans and as directed by the Engineer, in accordance with Section 403 of the 2012 edition of the MDOT Standard Specifications for Construction, and the City Standard Specifications, except as specified herein.

MATERIALS

Materials shall meet the requirements of sections 701, 702, and 908 of the 2012 MDOT Standard Specifications, except that concrete shall be MDOT HE, 8.4-sack per Section 601.

All covers and/or castings shall conform to the model(s) specified, as follows:

<u>Type of Casting</u>	<u>MDOT Designation</u>	<u>NEENAH No. (Weight, Lbs)</u>	<u>EJIW No. (Weight, Lbs)</u>
Flat Inlet Structure Cover	D		5000/Type M2 Sinusoidal Grate (275 lbs.)
Manhole Flange and Cover	B	R-1642 w/ Type C cover Type D cover (380 lbs.)	1040 w/ Type A cover Type M1 (300 lbs.)
Curb Inlet or Catch Basin	K	R-3249F (410 lbs.)	7045 (500 lbs.)

All storm sewer covers shall have the lettering "DUMP NO WASTE!" and a fish image. All other covers shall have "SEWER" or "W" cast in the surface, whichever is applicable.

Frames and covers shall have machined bearing surfaces. Covers shall have two, 1-inch vent holes located opposite each other and 6-inches from the edge.

Castings and covers for monument and water-valve boxes will be provided by the City. The Contractor shall transport these new castings and covers to the site from the City Utilities Department yard at 4251 Stone School Road (Wheeler Center).

CONSTRUCTION METHODS

Materials shall be stored by the Contractor at locations arranged by the Contractor, subject to the approval of the Engineer. The Contractor shall not store materials or equipment, including metal castings and steel plates, on any lawn area.

The Contractor shall deliver all salvaged covers and castings to the Wheeler Center within two days of their removal.

MEASUREMENT AND PAYMENT

**DETAILED SPECIFICATION
FOR
STRUCTURE COVERS**

2 of 2

Completed work as measured for these items of work will be paid for at Contract Unit Price for the following Contract (Pay) Items:

PAY ITEM

PAY UNIT

Structure Cover

Pounds

The unit prices for these items of work shall include all labor, material, and equipment costs to perform all the work specified in the Standard Specifications and as modified by this Detailed Specification.

Payment for transporting new and salvaged castings and covers to and from the Wheeler Center is included in the appropriate items of work.

**DETAILED SPECIFICATION
FOR
RECONSTRUCTING, REPAIRING, AND
ADJUSTING STRUCTURES**

1 of 3

DESCRIPTION

This work shall consist of repairing, reconstructing, adjusting, and lowering structures, valve wells or boxes, and monument boxes of concrete and concrete block masonry in accordance with Section 403 of the 2012 edition of the MDOT Standard Specifications for Construction, and the City Standard Specifications, except as specified herein, and except as directed by the Engineer.

MATERIALS

Materials shall meet the requirements of sections 701, 702, 902, 908, and 913 of the 2012 MDOT Standard Specifications, except that concrete shall be MDOT HE, 8.4-sack per Section 601.

Castings and covers for monument and water-valve boxes will be provided by the City. The Contractor shall transport these new castings and covers to the site from the City Utilities Department yard at 4251 Stone School Road (Wheeler Center).

CONSTRUCTION METHODS

General

Materials shall be stored by the Contractor at locations arranged by the Contractor, subject to the approval of the Engineer. The Contractor shall not store materials or equipment, including metal castings and steel plates, on any lawn area.

Hidden or unknown utility structures may be encountered during the work. It is the Contractor's responsibility to inform the respective utility owner(s) of such findings. In such instances, the City may direct the Contractor to adjust the structure(s) to grade. This work will be paid as "Adjust Structure Covers" and/or "Additional Depth Structure Adjustment/Repair" as applicable.

Covers shall be adjusted after the leveling, and/or patching course has been placed, unless otherwise authorized or directed by the Engineer.

All structure covers shall be adjusted such that their finished surface elevation is within ¼-inch of the finished surface sections, grades, slopes, and elevations, as shown on the Plans, and as directed by the Engineer. The work shall be verified by the use of a 10-foot straight-edge placed parallel with the pavement centerline. Structures not meeting the ¼-inch tolerance shall be readjusted and finish patched, as directed by the Engineer, at the Contractor's expense.

All structure covers, utility covers, valve boxes or monument boxes shall be backfilled with MDOT HE, 8.4-sack concrete from the depth of excavation necessary for adjustment, up to an elevation 2-inches below the top flange of the adjusted casting. This work shall be included in the respective items of work, and will not be paid for separately.

Reconstruct Structure

This item is the complete reconstruction of a catch basin, inlet, double inlet, or manhole structure of any depth and diameter, from the lowest pipe invert to the top of the structure. It shall include the salvaging/transporting of castings to the City yard, and the backfilling of the structure with Class II

sand compacted to 95% of its maximum unit weight as determined by the AASHTO T-180 test, all as directed by the Engineer.

Furnishing and installing 12-inch C-76 CL IV R.C.P. or 12-inch C-700 ES V.C.P. is not included in this item, but will be measured and paid for separately at the unit price for the Contract item "12-inch C-76 CL. IV R.C.P."

Adjust Structure Cover

This item includes the final adjustment of castings of any type (including drop inlets) to their respective finished elevations, up or down a maximum of 15 inches.

The Contractor is responsible to coordinate and arrange for the adjustment of all non-City utility manholes and valves (Edison, Gas, Cable, Ameritech, etc.) during this project. The Contractor will not be given any additional compensation for delays due to other utilities work. The work of coordinating with other utilities shall be paid for under the Contract Item "General Conditions."

Adjust Monument Box or Gate Valve Box

This item includes the final adjustment of existing or new covers up or down a maximum of 15 inches and to their finished elevations. This also includes the replacement of the top half of the water valve boxes and monument boxes (furnished by the City) where required, and shall be included in this item of work.

Additional Depth Structure Adjustment/Repair

Where the required adjustment on a structure is more than 15 inches from the existing elevation, the amount of the adjustment in excess of the first 15 inches shall be measured as additional depth by the vertical foot or fraction thereof. This shall also cover the repair of manholes and structures where less than the substantial rebuilding of the structure, as determined by the Engineer, is required.

Lower Structure Cover, and Lower Monument Box or Gate Valve Box

The Contractor shall remove and lower structure covers, monument boxes and gate valve boxes prior to the milling and pulverizing operations, and as directed by the Engineer.

Prior to the milling and pulverizing operations, the Project Supervisor shall coordinate and schedule the work of any independent survey crews which may be retained by the City to witness and reset existing and new geographic/benchmark monuments. Failure to have existing monuments witnessed and reset may result in delays to the Contractor's work. Costs for such delays will be the Contractor's sole responsibility.

After removing a structure's casting, the Contractor shall cover the structure's opening with a steel plate, in accordance with the details shown on the Plans. Plates shall be properly and carefully placed such that there is no slippage or shifting due to traffic or construction machinery movements.

It is the Contractor's responsibility to prevent construction debris from infiltrating into the structure. The Contractor shall cover the plate with either 21AA gravel or HMA pavement millings, and then place a 4-inch minimum thickness HMA patch up to the adjacent surface elevation. The furnishing and placement of 21AA gravel, HMA pavement millings, and HMA patching material will not be paid for separately, but is included in these items of work.

Steel plates shall be sufficiently strong and thick enough to carry the traffic and construction

equipment with no deflection, and shall be secured in place (pegged) as shown on the Plans, in order to prevent their shifting/moving.

Structures shall be thoroughly cleaned of any and all debris prior to placing steel plates. The Contractor shall coordinate and schedule an inspection by the Engineer, after the cleaning and prior to the plating, of all structures.

After the completion of HMA leveling course, the Contractor shall excavate and remove the steel plates, and shall immediately thereafter install and adjust the new/reused steel casting to finished elevations.

Steel plates are the property of the Contractor and shall be removed by the Contractor upon completion of the work.

If the Contractor anticipates a time period of five days or more between lowering and adjusting of casting(s), then the cover(s) shall be removed from the site and stored by the Contractor, until the expected adjustment time.

Point Structure

This item consists of pointing structures where shown on the Plans and as directed by the Engineer.

MEASUREMENT AND PAYMENT

Payment for transporting new and salvaged castings and covers to and from the Wheeler Center is included in the appropriate items of work.

Furnishing and placing flowable fill as backfill for these items will not be paid separately, but shall be included in the bid prices for these items of work.

Completed work as measured for these items of work will be paid for at Contract Unit Price for the following Contract (Pay) Items:

<u>PAY ITEM</u>	<u>PAY UNIT</u>
Reconstruct Structure	Each
Additional Depth Structure Adjustment and Repair	Vertical Foot
Temp Lowering Existing Structure	Each
Temp Lowering Existing Box	Each
Adjust Structure Cover	Each
Adjust Monument Box	Each
Adjust Gate Valve Box	Each
Point Existing Structure	Each

The unit prices for these items of work shall include all labor, material, and equipment costs to perform all the work specified in the Standard Specifications and as modified by this Detailed Specification.

CITY OF ANN ARBOR
SPECIAL PROVISION
FOR
HMA APPLICATION ESTIMATE

AA: JAN

1 of 1

1/26/16

a. Description. This work shall consist of furnishing and placing (HMA) hot mix asphalt on the prepared aggregate or milled surfaces in accordance with the details shown on the plans and as specified in Section 501 of the Michigan Department of Transportation Standard Specifications for Construction, 2012 Edition with the exceptions and additions specified herein.

b. Materials.

Mainline Paving:

The HMA, 5E3 used for top course shall have a yield of 165 pounds per square yard with a PG 64-28 binder. The HMA, 5E3 used for top course shall have an AWI = 260 minimum. The percent of binder weight by RAP shall be a maximum of 17%. The use of RAS is prohibited.

The HMA, 4E3 used for leveling course shall have a yield of 275 pounds per square yard with a PG 64-28 binder.

The HMA, 3E3 used for base course shall have a yield of 410 pounds per square yard with a PG 58-22 binder.

HMA Approaches and Finish Wedging:

The HMA, 36A or LVSP used for the approaches shall have a variable yield, with an average of 220 pounds per square yard with a PG 58-28 binder.

HMA Hand Patching:

The LVSP used for hand patching shall have a variable yield, with an average of 220 pounds per square yard with a PG 64-28 binder.

c. Construction. Construction shall be in accordance with Section 501 of the 2012 MDOT Standard Specifications for Construction, and the Detailed Specifications for HMA Paving and HMA Acceptance contained within the contract documents.

A bond coat shall be applied before each lift of HMA mixture is placed. The rate of application shall be 0.10 gallons per square yard.

d. Measurement and Payment. Measurement shall be based on load weight tickets from a certified scale and accepted at the job site by a City of Ann Arbor agent.

Payment for HMA 5E3, 4E3, 3E3, HMA Hand Patching and HMA Finish Wedging shall include all labor, equipment and materials to complete this work.

CITY OF ANN ARBOR
DETAILED SPECIFICATION
FOR
HMA PAVING

AA:DAD

1 of 3

04/09/15

a. Description. Hot Mix Asphalt (HMA) pavement base, leveling, and top courses shall be constructed in accordance with section 501 of the Michigan Department of Transportation (MDOT) 2012 Standard Specifications for Construction, except as modified herein, and as directed by the Engineer.

b. Materials. None specified.

c. Construction Methods.

1. Equipment: All equipment shall conform to subsection 501.03.A of the MDOT 2012 Standard Specifications for Construction, except as modified herein.

The Contractor shall have a 10 foot long straight edge, rubber-tired backhoe (Case 580 type, or equivalent), air-compressor with the ability to develop a minimum pressure of 100 pounds per square inch and continuous rated capacity of 150 cubic feet per minute of air flow, and jackhammer available during all paving operations. The Contractor shall be required to perform any miscellaneous cleaning, trimming, material removal, and other tasks as required by the Engineer in order to ensure the proper and orderly placement of all HMA materials on this project.

The Contractor shall provide sufficient rollers to achieve the specified asphalt densities.

At various times throughout the work, the Engineer may direct the Contractor to use smaller and/or lighter equipment, and to defer certain work tasks, in order to protect the grade and/or adjacent areas; including hauling units. The Contractor shall not be entitled to any additional compensation for the use of smaller equipment, lighter equipment, or work task deferral.

2. Cleaning and Bond Coat Application: Cleaning and bond coat application shall be performed in accordance with subsections 501.03.C and 501.03.D of the MDOT 2012 Standard Specifications for Construction, except as modified herein, and as directed by the Engineer.

The Contractor shall furnish and operate throughout the construction period, vacuum-type street cleaning and utility structure cleaning equipment (Vac-All, Vactor, etc.) approved by the Engineer, and when directed by the Engineer, for street cleaning immediately prior to, and for street and utility structure cleaning after any and all paving. The cleaning equipment shall be of sufficient power to remove dust, dirt, and debris from the pavement and from utility structures in and adjacent to the construction area. The vac-all or similar equipment and shall be approved by the Engineer prior to beginning the work. The equipment used shall have an effective means for preventing any dust resulting from the operation from escaping into the air.

The bond coat shall be applied at a rate of 0.10 gallons per square yard. Before placing the bond coat, the existing pavement surface shall be thoroughly cleaned. The Contractor shall also thoroughly clean all joints, cracks, and edges to a minimum depth of one inch with compressed air, vac-all type equipment, or other approved mechanical or hand methods, to remove all dirt, debris, and all foreign material.

3. HMA Placement: Placement shall conform to subsection 501.03.F of the MDOT 2012 Standard Specifications for Construction, except as modified herein, and as directed by the Engineer.

HMA placement shall not commence until a "Permit to Place" (no additional costs are required to obtain this permit) has been issued in writing by the Engineer. The Permit to Place shall be issued after the aggregate base course or the adjacent, underlying layer of pavement section has been approved by the Engineer.

The final structure adjustments must be approved by the Engineer prior to the issuance of the "Permit to Place" for the top course.

The top course shall be placed with a ¼" lip at the gutter edge of metal.

All HMA thickness dimensions are compacted-in-place.

4. Paving Operation Scheduling: The Contractor shall schedule the paving operation to avoid longitudinal cold joints that would be required to be left "open" over night.

In all cases, the Contractor shall pave the primary road's through-traffic lanes ("main line") first, from point-of-beginning to the point-of-ending. All other paving including, but not limited to; acceleration and deceleration lanes, intersection approaches, and center left-turn lanes shall be paved following completion of main line paving, unless authorized by the Engineer prior to the placement of any pavement.

5. Rate of Paver Operation: The rate of the paver's travel shall be maintained such that the paving operation will be continuous; resulting in no transverse cold joints, but shall never exceed the rate of 50 feet per minute.

The Contractor shall furnish and operate enough material, equipment, and hauling units so as to keep the paving machine(s) moving continuously at all times. Failure to do so shall be cause for the suspension of the paving operation until the Contractor can demonstrate to the satisfaction of the Engineer, that sufficient resources have been dedicated to perform the work in accordance with the project specifications.

6. Longitudinal and Transverse Joints: These joints shall conform to subsection 502.03.F of the MDOT 2012 Standard Specifications for Construction, and as specified herein.

For mainline HMA paving, the width of the mat for each pass of the paver shall be not less than 10.5 feet, or greater than 15 feet, except as noted in the plans and as directed by the Engineer. The Engineer will direct the layout of all HMA longitudinal joints during construction.

7. Feather Joints – shall be constructed so as to vary the thickness of the HMA from zero inches to the required paving thickness at the rate of approximately 1.5” over a distance of 10 feet, or as directed by the Engineer. The Contractor shall rake the larger pieces of aggregate out of feather joints prior to compaction.

8. Butt Joints: Construction of butt joints, where directed by the Engineer, shall conform to subsections 501.03.C.3 and 501.03.C.4 of the MDOT 2012 Standard Specifications for Construction, except as modified herein.

When a butt joint is specified or directed to be placed by the Engineer, remove the existing HMA surface to the thickness of the proposed overlay, or full-depth, as directed by the Engineer, for the full width or length of the joint. The HMA material shall be sawcut to the directed depth along the pavement edge or removal line to prevent tearing of the pavement surface. Cut joints that will be exposed in the completed surface must be cut with a saw or a cold-milling machine or other methods approved by the Engineer. Joints that will be covered by HMA must be cut with a saw, a cold-milling machine, or other methods approved by the Engineer.

9. Rakers: The Contractor shall provide a minimum of two asphalt rakers during the placement of all wearing and leveling courses.

10. Faulty Mixtures: The Contractor and Engineer shall carefully observe the paving operation for signs of faulty mixtures. Points of weakness in the surface shall be removed or corrected by the Contractor, at his/her sole expense, prior to paving subsequent lifts of bituminous material. Such corrective action may include the removal and replacement of thin or contaminated sections of pavement, segregated HMA, and any sections that are weak or unstable. Once the Contractor or his representative is notified by the Engineer that the material being placed is out of allowable tolerances, or that there is a problem with the paving operation, the Contractor shall stop the paving operation at once, and shall not be permitted to continue placing bituminous material until again authorized by the Engineer. Any costs associated with meeting the requirements specified herein shall not be paid for separately, but shall be included in the item(s) of work being performed at the time the faulty mixture was discovered.

d. Measurement and Payment. Unused HMA remaining in trucks after the work is completed shall be returned to the plant and re-weighed, and the corrected weight slip shall be provided to the Engineer. No payment will be made for the unused HMA material. All weight slips must include the type of mixture (codes are not acceptable), as well as vehicle number, gross weight, tare weight and net weight.

All costs of meeting the requirements of this special provision shall be included in the bid prices for HMA items in the proposal and will not be paid for separately.

CITY OF ANN ARBOR
DETAILED SPECIFICATION
FOR
ACCEPTANCE OF HMA MIXTURES

AA:MGN
FHWA 01/14/14

1 of 4

01/14/14

a. Description. This special provision establishes acceptance criteria for HMA Mixtures on City of Ann Arbor projects. The HMA mixtures shall meet all the requirements of section 501 of the Michigan Department of Transportation (MDOT) 2012 Standard Specifications for Construction, except as modified herein.

b. Contractor Quality Control. The Contractor must have a quality control plan as required by subsection 501.03.M of the MDOT 2012 Standard Specifications for Construction, and as stipulated herein. The Quality Control (QC) Plan shall be submitted to the Engineer within 30 days of contract award or 14 days before the placement of any HMA materials, whichever date comes first. The QC Plan shall cover all aspects of HMA production, transportation, placement, and compaction. The Contractor shall have a QC representative on-site at all times during the paving operations to monitor and direct all paving-related operations. The placement of HMA shall not commence until such time as the QC Plan has been accepted by the Engineer. The Engineer's acceptance of the QC Plan shall not be construed as a basis of acceptance of any HMA materials, HMA placement results, or a waiver of any requirement(s) of the project specifications.

c. Materials. Aggregates, mineral filler (if required), and asphalt binder shall be combined as necessary to produce a mixture proportioned within the specification requirements including aggregate gradation; the mix design criteria including volumetric properties; the Superpave Gyrotory (SGC) compaction criteria; and the uniformity tolerances listed in Table 1. Topsoil, clay, or loam shall not be added to aggregates which are to be used in plant mixed HMA mixtures.

d. Mix Designs. The Contractor shall submit mix designs for evaluation in accordance with the Michigan Department of Transportation Hot Mix Asphalt Production Manual. All mix designs shall be submitted for review a minimum of 3 weeks prior to the anticipated placement of the HMA. The Contractor's production and paving schedules shall be considered to include the mix design review and approval process. Delays associated with the submittal, or re-submittal, of the required information shall not be a basis for an extension of contract time.

e. Construction. Target air voids shall be 4% in leveling courses, top courses and shoulders paved in the same operation as the leveling and top courses. Target air voids shall be 3% in base courses and shoulders not paved in the same operation as the leveling and top courses. Pedestrian paths shall have a target air void content of 3%.

After the job-mix-formula (JMF) is established, the parameters identified in Table 1 shall be maintained within the Range 1 tolerance limits of Table 1. If deviations are predominately below or above the JMF the Engineer may order alterations in the plant to bring the mixture into better conformance with the JMF.

Should the HMA furnished fail to meet the Range 1 acceptance criteria for any parameter, the Contractor shall suspend all operations. Contract time will continue during these times when the plant is down. Before resuming any production, the Contractor shall propose, for the Engineer's approval, all necessary alterations to the materials or plant so that the JMF can be maintained. The Engineer, after evaluating for effects on the AWI and mix design properties, will approve or disapprove such alterations.

Acceptance sampling and testing will be performed by the Engineer using the sampling method and testing option selected by the Engineer. Quality control measures to ensure job control are the responsibility of the Contractor.

The crushed particle content of the aggregate used in the HMA mixture shall not be more than 10 percentage points above or below the crushed particle content used in the JMF, nor less than the minimum specified for the aggregates in the contract documents.

Pavement density will be measured by the Engineer with a nuclear density gauge using the G_{mm} from the JMF for the density control target. The required in-place density of the HMA shall be between 92.0 and 96.0 percent of the density control target. The Contractor is responsible for establishing a rolling pattern that will achieve the required in-place density. Should the specified target densities not be met, the material shall be considered to have a Range 2 failure and shall be rejected. If the Engineer determines that the material is suitable to remain in place, a 50% reduction to the unit price of all material affected shall be enacted by the Engineer. Should the Engineer determine that the material cannot remain in place; the affected material will be removed and replaced at the Contractor's sole expense as detailed in the Section entitled "Price Adjustments".

Acceptance Criteria

Table 1 – Uniformity Tolerance Limits for HMA Mixtures

Parameter	Top and Leveling Courses		Base Course	
	*Range 1	Range 2	*Range 1	Range 2
Air Voids	± 0.60	± 1.00	± 0.60	± 1.00
VMA	± 0.60	± 1.00	± 0.60	± 1.00
G_{mm} (maximum specific gravity of mixture)	± 0.013	± 0.020	± 0.013	± 0.020
Fines to Effective Binder Ratio (this parameter is independent of JMF)	0.6 to 1.2	0.6 to 1.4	0.6 to 1.2	0.6 to 1.4
Binder Content	± 0.30	± 0.40	± 0.30	± 0.40
Percent Passing No. 8 and Larger Sieves	± 5.0	± 8.0	± 7.0	± 9.0
Percent Passing No. 30 Sieve	± 4.0	± 6.0	± 6.0	± 9.0
Percent Passing No. 200 Sieve	± 1.0	± 2.0	± 2.0	± 3.0
*This range allows for normal mixture and testing variations. The mixture shall be proportioned to test as closely as possible to the Job-Mix-Formula.				

The tolerances specified in Table 1, with the exception of the Fines to Effective Binder Ratio, reflect variations from the approved job-mix formula.

Extraction and volumetric tests will be performed by the Engineer to confirm conformance to the specifications and the tolerances identified in Table 1. The minimum number of field extractions to be performed shall be in accordance with Table 2. The Engineer may elect to perform a minimum of 3 extractions per mixture, per day, for quantities less than 1000 tons.

Table 2 – Minimum Number of Extractions

Quantity (tons) of Single Mixture Placed per Day	Minimum Number of Extractions per Mixture per Day
<250	0
250 - 1000	2
1000 - 1500	3
1500 - 2000	4
2000 - 2500	5
2500 - 3000	6

e. Rejected Mixtures. If more than one half the extractions and/or volumetric tests for a single mixture, batched on a single day, exceed the uniformity tolerance of Range 2 for any parameter in Table 1, or do not meet the minimum requirements for crushed particle content specified in the project documents, the mixture will be rejected.

If such mixtures are placed in a pavement, the remaining portions of the failing field samples (split samples) will be tested by an independent, accredited, private laboratory, the MDOT Region Laboratory, or the MDOT Central Laboratory (for the purposes of this contract, any of these laboratories can be considered a 3rd Party testing laboratory) to confirm the field test results. If necessary, to obtain additional HMA material, the Engineer will take pavement cores. The Contractor may only take cores if approved in writing by the Engineer. If the 3rd Party test results do not confirm the original field test results, then no price adjustments will be made for the mixture involved.

If the 3rd Party's test results confirm the original field test results and, if in the Engineer's judgment, the mixture warrants removal, the Contractor shall remove and replace the entire mixture placed on a given day, at the Contractor's expense, with a mixture meeting the specification requirements.

If the 3rd Party's test results confirm the original field test results and, if in the Engineer's judgment, the mixture can remain in place, the contract unit price for the entire mixture placed on a given day will be decreased as described in the Section entitled "Price Adjustments".

If no field extractions are performed on a given day because the quantity being placed is less than 250 tons, and if there is reason to believe that the mixture exceeds Range 2, or if the crushed particle content is less than the established criteria, based on test results from a different day, the price reduction may also be applied, or removal may be required, based on extraction tests performed by the Engineer from pavement cores.

f. Price Adjustments. If more than one half of the field extractions for a single mixture, batched on a single day, exceed the uniformity tolerance of Range 1, but not Range 2, for any parameter in Table 1, the contract unit price will be reduced by 10 percent. Field tests indicating that mixtures are subject to the 10 percent penalty will be confirmed by 3rd party testing as described in the Section entitled "Rejected Mixtures".

If more than one half of the field extractions for a single mixture, batched on a single day, meet or exceed the uniformity tolerance of Range 2 for any parameter in Table 1, the material shall be removed and replaced at the Contractor's sole expense. These costs shall be deemed to include all costs associated with the material removal and replacement including, but not limited to; costs associated with re-mobilization of labor and equipment; traffic control; removal and disposal of the rejected material; transportation costs to provide material meeting the requirements of the specification; and any other cost associated with the work. Contract time shall continue during the period of time that the rejected material is investigated and re-tested, as well as, during the removal and replacement operations.

If no field extractions are performed on a given day because the quantity being placed is less than 250 tons, and the Engineer believes that the mixture exceeds Range 1 tolerances based on test results from a different day, the price reduction may also be applied, or removal may be required, based on material tests performed by the Engineer's representative from pavement core(s).

The Contractor will be back-charged for additional testing performed by the Engineer associated with mixtures which are rejected or penalized.

**DETAILED SPECIFICATION
FOR
PAVEMENT JOINT AND CRACK REPAIR – DETAIL 7
PAVEMENT JOINT AND CRACK REPAIR – DETAIL 8**

DESCRIPTION

This work shall consist of constructing pavement joint and crack repairs and hand patching in accordance with Section 501 of the 2012 edition of the MDOT Standard Specifications for Construction and the current version of MDOT Standard Detail R-44 (Details 7 and 8), except as modified herein, and as directed by the Engineer.

MATERIALS

Materials must meet the requirements of Section 501 of the 2012 edition of the MDOT Standard Specifications for Construction.

Removed material shall be replaced with a HMA wearing course mixture approved by the Engineer.

CONSTRUCTION METHODS

Prior to placing HMA patching material, all patch areas shall be cleaned with compressed air, and/or vacuum type street cleaning equipment (Vac-all), to remove dirt and loose material. Compressed air shall be from a source which provides a minimum of 90 psi and 150 cubic feet per minute of air at the nozzle.

All asphalt and concrete surfaces within all patch areas shall be covered with MDOT SS-1h bond coat, applied at a rate of 0.10 gallons/square yard. The bond coat shall be applied with a power distributor hand sprayer.

Removed material shall be replaced with a HMA wearing course mixture approved by the Engineer. The HMA shall be compacted with a machine vibrator or approved roller with base lift thicknesses not to exceed 3 inches and with the top lift thickness not to exceed 2 inches. The final surface of the repair shall be flush with the existing pavement.

MEASUREMENT AND PAYMENT

Payment for hand patching with an approved HMA mixture in repair areas shall be included in the unit price for the item of HMA Patching.

The completed work as measured for these items of work will be paid for at the Contract Unit Prices for the following Contract (Pay) Items:

<u>PAY ITEM</u>	<u>PAY UNIT</u>
Pavement Joint and Crack Repair – Detail 7	Foot
Pavement Joint and Crack Repair – Detail 8	Foot

The unit prices for these items of work shall include all labor, material, and equipment costs to perform all the work specified in the Standard Specifications and as modified by this Detailed Specification

**DETAILED SPECIFICATION
FOR
HAND PATCHING**

1 of 2

DESCRIPTION

This work shall consist of patching existing HMA and concrete pavements as specified in Section 501 of the 2012 edition of the MDOT Standard Specifications, current supplemental MDOT specifications, except as modified herein, and as directed by the Engineer.

MATERIALS

The HMA mixtures to be used for this work shall be LVSP or HMA 4E3 or 5E3, or as directed by the Engineer.

CONSTRUCTION METHODS

All areas excavated on any given day shall be patched, compacted and opened to traffic, that same day.

The Contractor shall provide a 10-foot long straight-edge during all paving operations.

The aggregate base and/or subgrade of all patch areas which are, or become, damp or wet, shall be dried by aerating, or by other methods approved by the Engineer.

The aggregate base and/or subgrade of each patch shall be evenly graded and trimmed, and shall be compacted by the use of a vibratory plate compactor or other approved method(s) to not less than 98% of its maximum unit weight.

Prior to placing HMA patching material, all patch areas shall be cleaned with compressed air, and/or vacuum type street cleaning equipment (Vac-all), to remove dirt and loose material. Compressed air shall be from a source which provides a minimum of 90 psi and 150 cubic feet per minute of air at the nozzle.

All asphalt and concrete surfaces within all patch areas shall be covered with MDOT SS-1h bond coat, applied at a rate of 0.10 gallons/square yard. The bond coat shall be applied with a power distributor hand sprayer.

The Contractor shall use an asphalt paver or spreader box to place HMA mixtures. The Contractor shall not use a grader, front-end loader or any similar device to place HMA mixtures. For small areas, where approved by the Engineer, the Contractor may place the material by hand directly into patch areas. The Contractor shall not place HMA materials on adjacent pavement surfaces.

HMA mixtures shall be placed in lifts not exceeding 3-inches (approximately 3½-inch loose). Each layer of HMA mixture shall be compacted to between 92 to 96 percent (or as determined acceptable by the engineer) of the theoretical maximum density, as listed on the approved Job Mix Formula.

HMA mixtures shall be compacted by the use of an approved vibratory roller. At small patches, an approved vibratory plate compactor shall be used.

MEASUREMENT AND PAYMENT

Measurement shall be by the ton, in place. Unused HMA material shall be returned to the plant and re-weighed, and a corrected weight slip shall be provided to the Engineer. Weight slips shall include the type of mixtures (codes are not acceptable), as well as the truck number, gross weight, tare weight and net weight.

The completed work as measured for these items of work will be paid for at the Contract Unit Prices for the following Contract (Pay) Items:

PAY ITEM

PAY UNIT

Hand Patching, HMA ____

Ton

The unit prices for these items of work shall include all labor, material, and equipment costs to perform all the work specified in the Standard Specifications and as modified by this Detailed Specification.

**DETAILED SPECIFICATION
FOR
HMA WEDGING**

1 of 2

DESCRIPTION

This work shall consist of constructing HMA finish wedges at drive approaches, sidewalk ramps, and any other locations, in accordance with Section 501 of the 2012 edition of the MDOT Standard Specifications, current supplemental MDOT specifications, except as modified herein.

MATERIALS

The HMA mixture to be used for this work shall be MDOT HMA 36A, LVSP or an acceptable substitute as directed by the Engineer.

CONSTRUCTION METHOD

The Contractor shall complete all finish wedging within two days of placement of the wearing course.

The Contractor shall have a 10-foot long straight-edge, backhoe, air-compressor and jackhammer available during all paving operations.

Finish wedges shall provide good vertical and horizontal transitions between old and new construction, shall eliminate areas of standing water in the wearing surface, and shall provide positive drainage.

The Contractor shall construct feather joints at the edges of all finish wedges (including the raking out of all large pieces of aggregate), so as to provide a high quality, smooth riding surface.

Prior to placement of wedging material, the surface shall be cleaned with compressed air and/or vacuum type street cleaning equipment.

All asphalt and concrete surfaces within the wedging area shall be covered with MDOT SS-1h bond coat, applied at a rate of 0.10 gallons/square yard. The bond coat shall be applied with a power distributor hand sprayer.

MEASUREMENT AND PAYMENT

Measurement shall be by the ton, in place. Unused portions of material loads shall be returned to the plant and re-weighed and the corrected weight slip shall be provided to the Engineer. All weight slips must include type of mixture delivered to the site (codes are not acceptable), as well as vehicle number, gross weight, tare weight and net weight.

The completed work as measured for these items of work will be paid for at the Contract Unit Prices for the following Contract (Pay) Items:

PAY ITEM

HMA, Wedging, ____

PAY UNIT

Ton

The unit prices for these items of work shall include all labor, material, and equipment costs to perform all the work specified in the Standard Specifications and as modified by this Detailed Specification.

**DETAILED SPECIFICATION
FOR
COLD MILLING BITUMINOUS PAVEMENT
COLD MILLING PAVEMENT, CURB REVEAL**

1 of 2

DESCRIPTION

This work shall consist of removing HMA, aggregate and concrete pavement materials from roadbeds and/or other paved areas, by use of cold milling equipment, in accordance with Section 501 of the 2012 MDOT Standard Specifications for Construction.

These items are not intended to be used for the general milling of concrete streets. These items are intended to be used to pay for all of the milling (HMA, aggregate, and concrete layers) on HMA paved streets with either an aggregate or concrete base.

CONSTRUCTION METHODS

HMA, aggregate, and concrete surface(s), shall be milled to the depths, widths, grades, profiles, and cross sections, all as indicated on the Plans, as detailed in the Specifications, and as directed by the Engineer. After a location is milled, the work will be inspected by the Engineer. The number of intersections and areas to be milled may be increased or decreased by the City, with no adjustment to unit prices for changes in quantities of these items of work.

In areas where the existing concrete gutter pan has been overlaid with HMA material, the Engineer may direct the Contractor to perform localized cold milling at the edge-of-metal to reveal a vertical face at the edge-of-metal of the curb. This localized milling shall be paid for at the Unit Price for Contract Pay Item "Cold Milling of Pavement, Curb Reveal." Subsequent handwork and machine work to remove and dispose of existing HMA overlays from the gutter pan will not be paid for separately, but will be paid for with this item.

After milling, the Contractor shall remove, add to, re-shape, re-grade, and re-compact the existing roadbed materials, and shall construct the roadway to the cross-section(s) as indicated on the Plans, as detailed in the Specifications, and as directed by the Engineer. The Contractor shall use blade graders, maintainers, vibratory rollers, and/or other equipment as necessary, and as directed by the Engineer, for this work. Use of each specific piece of equipment is subject to the approval of the Engineer.

The Engineer may direct aggregate base materials to be either removed from or added to the job-site, to properly complete the work. Where the Engineer directs the addition of such materials, they shall be paid for as either the Item of Work: "Aggregate Base Course 21AA - C.I.P.", or "21AA Limestone - C.I.P.", as appropriate. Where such materials are directed to be removed, they shall be paid for as the Item of Work: "Cold Milling Pavement."

Where the Contractor removes material below the grade(s) specified, the resulting voids or depressions shall be backfilled and compacted by the Contractor, at the Contractor's expense, by hand patching, with a HMA mixture approved by the Engineer, in accordance with section 502.03.C.5 of the 2012 edition of the MDOT Standard Specifications for construction.

Handwork required to remove HMA curbing, HMA driveway wedges, and HMA surfaces around other miscellaneous areas within the milling limits, will not be paid for separately, however the tonnage of material removed by handwork will be paid for as these items of work. Unless paid for

elsewhere within the contract, handwork required to remove HMA, aggregate, and/or concrete surfaces from around manholes, structures, and utility covers, shall also be included in this item of work.

Prior to placing asphalt, all milled areas, including joints and cracks, shall be cleaned of all loose material with vacuum type street cleaning equipment.

EQUIPMENT

Cold milling machines shall have continuously variable depth controls, capable of removing, in a single pass, HMA, aggregate, and concrete materials having a combined thickness of up to 4 inches. Cold milling machines shall be capable of accurately removing the HMA, aggregate, and concrete surface(s), in one or more passes, to the grades and cross sections shown on the Plans, and as directed by the Engineer.

The equipment shall have enclosed cutting drums with a water sprinkling system around the reduction chamber for pollution control, and shall remove excess material from the surface, while preventing dust from escaping into the air.

MEASUREMENT AND PAYMENT

The completed quantities of these items of work will be measured by weighing the millings at a location approved by the Engineer. The Contractor shall provide the Engineer with computerized weight tickets for milled material. Each load ticket must include the truck number; gross, tare, and net weight; time of day, and date. The Contractor shall provide a daily tabulation of tare weights for all trucks used. The tare weights on each load ticket will be checked against the tare weights provided on the daily tabulation, and their compliance will also represent basis for payment. All trucks shall have their tare weight checked daily.

The completed work as measured for these items of work will be paid for at the Contract Unit Prices for the following Contract (Pay) Items:

<u>PAY ITEM</u>	<u>PAY UNIT</u>
Cold Milling Bituminous Pavement	Ton
Cold Milling Pavement, Curb Reveal	Ton

The unit prices for these items of work shall include all labor, material, and equipment costs to perform all the work specified in the Standard Specifications and as modified by this Detailed Specification.

SPECIAL PROVISION
FOR
GEOSYNTHETIC PAVING LAYER

AA:JN

1 of 2

1/29/16

a. Description of Work. The Work shall include all Equipment, Materials, and Labor necessary to prepare the milled surfaces for laying and applying said paving Interlayer, and shall be constructed as follows.

This work shall consist of prepping the surface, furnishing, and installing a Geosynthetic Paving Layer on the leveling course before installing the new HMA top course as shown on the plans. The material shall not have any tears or holes that will adversely affect the in-situ performance and physical properties of the installed material.

b. Materials.

The asphalt tack coat shall be hot applied asphalt cement meeting grade requirements of AC, AR, or PG specifications. It is recommended that an AC20, PG 64-22 or a 60-80 penetration grade of asphalt be applied for normal installations and temperatures. For temperatures over 90 degrees Fahrenheit, higher viscosity asphalt should be used. AC-30, PG 70-10 or 40-60 penetration grades are appropriate.

The Geosynthetic Paving Layer shall be a non-woven fiberglass/polyester interlay paving material (F/P Interlayer) or approved equal.

At a minimum the material shall meet the following physical property requirements:

Mechanical Property	Test Method	Unit	Typical Value
Tensile Strength, MD	ASTM D5035	Lbf/in	>80
Tensile Strength, CD	ASTM D5035	Lbf/in	>70
Elongation at Maximum Load,	ASTM D5035	%	<5
Asphalt Retention	ASTM D6140	Gal/yd ²	0.18
Melting Point	ASTN D276	°F	>446
Mass per Unit Area	ASTM D5261	Oz.yd ²	4.0

Notes:

- 1) MD = Machine Direction (longitudinal to the roll)
- 2) CD = Cross Direction (across roll width)
- 3) Note: Conditions for tensile strength measurements:
 - a. Sample width: 2 inches Sample Length: 10 inches
 - b. Gage Length: 7 inches Crosshead Speed: 2 inches/minute

The mat manufacturer shall furnish certified test data covering the physical and engineering properties of the mat. A letter of certification shall be furnished with each shipment stating that the paving mat complies with the specification requirements.

c. Construction. Installation of paving mat interlayer shall be performed or supervised during startup by a trained and experienced installer certified by the manufacturer of their agent(s).

Surface to be overlaid with the paving mat shall be cleaned, dry, and free and clear of all dirt and debris.

The tack coat shall be applied by a motorized distributor (spreader) that has the capability of adjusting spray rates by 1/10 gal/sq yd. The valves on the distributor bar must fan in an overlap fashion at the application rate. The recommended application is 0.15 gal/sq. yd. Every effort should be made in order to install paving mat over hot asphalt tack coat.

The paving mat interlayer can be placed by tractor or a distributor truck with a fabric applicator attached to the back. The mat shall be installed to the surface using mechanically powered installation equipment or by hand installed means. Mechanical equipment shall be capable of installing rolls 3.0 feet in width. The installation by hand will only be used in situations where areas require specially cut sections, and/or where mechanically installed methods cannot be accomplished. Brooms or squeegees shall be used to remove any air bubbles and ensure paving mat is completely in contact with the tack-coated surface. Folds or wrinkles that are encountered during lay down operations shall be cut or smoothed and additional tack material shall be applied as needed to achieve a complete bond to the surface.

Paving mat shall be overlapped according to the manufacturer's specifications. Overlaps on the transverse roll ends shall be in the direction of the paving operation to avoid paving mat pick-up during asphalt installation. All overlapping of paving mat shall be tack coated to ensure proper adhesion.

d. Measurement and Payment. Any deviations or alterations or any work not specifically called for in plans yet deemed necessary to install paving interlayer and approved by Engineer shall be considered incidental to constructing paving interlayer and shall not be paid for separately.

The Geosynthetic Paving Layer shall be paid for in accordance with these plans and specifications. No allowance will be made for overlaps, splices or material cut off and/or wasted. Measurement is based on square yards of material placed at the time of completion and accepted at the job site by a City of agent and paid at the contract unit price for:

<u>Pay Item</u>	<u>Pay Unit</u>
Geosynthetic Paving Layer	Square Yard

Payment for Geosynthetic Paving Layer shall include all labor, equipment and materials to complete this work.

CITY OF ANN ARBOR
 DETAILED SPECIFICATION
 FOR
CONCRETE CURB AND GUTTER, AND DRIVEWAY OPENINGS

AA:DAD

1 of 2

04/06/15

a. Description. This work shall consist of constructing concrete curb and gutter, and concrete driveway openings in accordance with the detail included in the contract documents, section 802 of the MDOT 2012 Standard Specifications for Construction, and as specified herein.

b. Materials. The materials shall meet the requirements as specified in section 802 of the MDOT 2012 Standard Specifications for Construction and as specified herein:

The concrete mixture for driveway openings and curb and gutter shall be Grade P-NC (658 lbs/cyd cement content) concrete with 6AA coarse aggregate.

All concrete mixtures shall contain 6AA coarse aggregates which are either natural or limestone and meet the requirements of section 902 the MDOT 2012 Standard Specifications for Construction.

It shall be the Contractor's sole responsibility to propose specific concrete mix designs which meet the requirements of this Detailed Specification.

c. Construction. Construction methods shall be in accordance with section 802 of the MDOT 2012 Standard Specifications for Construction.

Curb and gutter shall be 2 feet wide barrier curb and gutter with steel reinforcement per the detail included in the contract documents, and constructed where shown in the plans.

Expansion joints of the thickness shown on the details shall be placed as directed by the Engineer.

d. Measurement and Payment. The completed work, as described, will be measured and paid for at the contract unit prices respectively for the following pay items:

<u>Pay Item</u>	<u>Pay Unit</u>
Curb & Gutter, Conc, Barrier.....	Foot
Drive Opening, Conc, Type M	Foot

The pay items will be measured in length by the foot and will be payment in full for all labor, equipment and material needed to properly complete this work, including but limited to steel reinforcement, curing compound, and expansion joint material.

At curb openings for sidewalk ramps, the concrete curb and gutter (without the curb face) will be measured and paid for at the contact unit price for curb and gutter.

Where the Engineer directs the use of high early strength concrete for pay items that are not specifically designated to use Grade P-NC concrete, the additional cement shall be paid for

separately. No additional payment will be made for cement for pay items that are designated to use Grade "P-NC." concrete.

**DETAILED SPECIFICATION
FOR
CONCRETE DURABILITY**

1 of 6

DESCRIPTION

The Contractor shall furnish a Portland cement concrete mixture for this project that has been tested under this specification and shown to be resistant to excessive expansion caused by alkali-silica reactivity (ASR) and provides adequate air entrainment for freeze thaw durability. The Contractor shall construct the project with practices outlined in this specification.

MATERIALS

The materials provided for use on this project shall conform to the following requirements:

Portland cement	ASTM C 150
Fine Aggregate	ASTM C 33*
Coarse Aggregate	ASTM C 33*
Fly Ash, Class F	ASTM C 618
Slag Cement, Grade 100, 120	ASTM C 989
Silica Fume	ASTM C 1240
Blended Cements	ASTM C-595
Air Entraining Admixtures	ASTM C-260
Chemical Admixtures	ASTM C-494
White Membrane Cure	ASTM C-309 Type 2

* Fine and coarse aggregates shall consist of natural aggregates as defined in the 2012 MDOT Standard Specifications Section 902.02.A.1.

The Contractor shall provide documentation that all materials to be incorporated into proposed mixed designs meet the requirements of this section.

Alkali-Silica Reactivity

The Contractor shall supply to the Engineer preliminary concrete mix designs including a list and location of all suppliers of concrete materials. The Contractor shall evaluate the mixtures for the potential for excessive expansion caused by ASR and provide documentation to the Engineer. The Contractor's evaluation shall include a review of any previous testing of the material sources intended to be used for both the fine and coarse aggregates for the concrete mixtures. The previous testing may be from other projects or records provided by the material suppliers.

Aggregates shall be tested under ASTM C-1260. If the expansion of the mortar bars is less than 0.10%, at 14 days, the aggregates shall be considered innocuous and there are no restrictions for ASR mitigation required with this material.

Previous aggregate test data may be used. If no previous test data is available, for the concrete mix, that shows that it is resistant to ASR, a concrete mixture that will mitigate the potential for ASR must be designed using either method 1 or 2 as described below.

Method 1. Substitution of a portion of the cement with Class F Fly Ash, Slag Cement Grade 100 or 120 or a ternary mix (blended cement) containing a blend of Portland cement and slag cement, or Class F fly ash, or silica fume.

The maximum substitution of cement with the fly ash permitted shall be 25% by weight of total cementitious material (cement plus fly ash). Additional requirements for the Fly Ash, Class F are that the Calcium Oxide (CaO) percent shall be less than 10 % and the available alkalis shall not exceed a maximum of 1.5%. A copy of the most recent mill test report shall be submitted to verify. Note: a Class C fly ash with a minimum total oxides ($\text{SiO}_2 + \text{Al}_2\text{O}_3 + \text{Fe}_2\text{O}_3$) of 66% and a minimum SiO_2 of 38% may be used in lieu of Type F fly ash.

The maximum substitution of cement with the Slag Cement permitted shall be 40% by weight of total cementitious material (cement plus Slag Cement). The minimum replacement rate with Slag Cement shall be 25%.

For a ternary blend the total replacement of supplementary cementitious materials is 40% with a blend consisting of a maximum of 15% type F fly ash, and/or 8% silica fume and/or slag cement.

For method 1, the effectiveness of the proposed mix combination to resist the potential for excessive expansion caused by ASR shall be demonstrated using current or historic data. To demonstrate the effectiveness of the proposed mix the Contractor shall construct and test mortar bars per ASTM C1567 (14 day test) using both the fine and coarse aggregate along with the proposed cementitious material for the concrete mixture. If a mortar bar constructed of these materials produces an expansion of less than 0.10%, concrete mixture will be considered to be resistant to excessive expansion due to ASR.

If a mortar bar constructed produces an expansion of 0.10% or greater, concrete mixtures containing these materials shall not be considered resistant to the potential for excessive expansion due to ASR and shall be rejected. Additional testing, including alternate proportions or different materials will be required.

Method 2. Use low alkali cement and maintain the total alkali content from the cementitious at no more than 3.0 lbs/cyd ($\text{Na}_2\text{O}_{\text{eq}}$). The total alkali contribution is calculated by the quantity contained in the Portland cement only.

Requirements for Low Alkali Cement are that the alkali content does not exceed 0.60% expressed as Na_2O equivalent. Equivalent sodium oxide is calculated as: (percent Na_2O + 0.658 x percent K_2O).

For either method 1 or 2, if the Contractor intends to change any component material supplied after the mix design has been approved all concrete work will be suspended with no cost to the project or extensions of time, unless approved, until evaluation of the new mixtures and testing of the new materials demonstrates that it is resistant to excessive expansion due to ASR.

The Engineer and Contractor shall monitor the concrete that is delivered to the project site so as to insure that the approved mix design is being followed. The supplier shall include on the delivery ticket for each batch of concrete delivered to the job, the identification and proportions of each material batched.

When concrete is placed during cold weather, defined for the purposes of this Detailed Specification to be, air temperatures below 40° F, the use of accelerators, heated aggregates, silica fume and/or additional forms of cold weather protection will be required. Cold weather will not eliminate the requirement for furnishing and placing a concrete mix that is considered resistant to ASR attack.

Prior to cool weather placement, defined for the purposes of this detailed specification to be, air temperatures between 40° and 60° F, the set time of the proposed mix shall be verified under anticipated field conditions. This information shall be used when scheduling pours and saw crews.

Air Entrainment

Air entrainment shall be accomplished by addition of an approved air entraining agent. Air content as determined by ASTM C 231 or ASTM C 173, shall be determined on each day of production as early and as frequently as necessary until the air content is consistently acceptable. If during the period of time while adjustments are being made to the concrete to create a mixture that is consistently acceptable, concrete is produced that does not meet the requirements of this Detailed Specification, the Engineer may reject the material and direct it to be removed from the jobsite. Any rejected material shall be removed from the jobsite at the Contractor's sole expense. Quality Control testing performed by the Contractor to ensure compliance with the project specifications shall be performed on the grade ahead of the placement operation.

Paver placement: During production, the plastic concrete material shall be tested for acceptance at a point ahead of the paver. The air content of the concrete mixture that the Contractor shall provide shall be known as the Acceptance Air Content (AAC). The Contractor shall also provide additional entrained air in the concrete mixture to account for the air loss which occurs in the concrete mixture experienced during transportation, consolidation and placement of the concrete. The "air loss" shall be added to the air content of the concrete mixture as established on the approved concrete mix design. The AAC for the project will be 6.0% plus an amount equal to the air loss.

For up to the first four loads, the air content measured on-site prior to placement shall be at least 8.0% and no more than 12.0%. To establish the initial AAC on the first day of paving, the air content of the first load shall be tested at the plant. After initial testing at the plant the Contractor shall provide at least two sample sets to determine the actual air loss during placement. A sample set shall consist of two samples of concrete from the same batch, one taken at the point of discharge and the other from the in-place concrete behind the paver. The air loss from the two sample sets shall be averaged and added to 6.0% to establish the AAC (rounded to the next higher 0.5%). After the testing and adjustment procedure(s) have been completed, the project acceptance air tests shall be taken prior to placement. The Contractor shall provide concrete to the jobsite that has an air content of plus 2.0%, or minus 1.0%, of the AAC.

After the AAC has been established, it shall be verified and/or adjusted through daily checks of the air loss through the paver. The Contractor shall check the air loss through the paver a minimum of two times a day. A Revised AAC shall be required to be established by the Contractor if the average air loss from two consecutive tests deviates by more than 0.5% from the current accepted air loss. The testing operations performed by the Contractor to establish a

revised AAC shall be performed to the satisfaction of the Engineer. The Contractor shall be solely responsible for any delays and/or costs that occur to the project while establishing revised AACs.

Hand placed concrete: The air content for non-slip-form paving shall be 7.0% plus 1.5%, or minus 1.0%, at the point of placement.

CONSTRUCTION METHODS

Aggregate Control

Gradation control – The supplier shall provide a detailed stockpile management plan, describing their process control procedure for shipping, handling, and stockpiling of each aggregate including workforce training.

Moisture control – All aggregate materials must be conditioned to a moisture content of not less than saturated surface dry (SSD) prior to batching. A watering process using an effective sprinkler system designed and operated by the Contractor shall be required on all coarse aggregate material stockpiles.

The Contractor shall provide verification that these processes have been performed by the supplier. The Engineer reserves the right to independently verify that the supplier has complied with these standards.

Mixing

Central mix plants - The total volume of the batch shall not exceed the designated size of the mixer or the rated capacity as shown on the manufacturer's rating plate.

Drum Mix Plants: After all solid materials are assembled in the mixer drum; the mixing time shall be a minimum of 60 seconds and a maximum of 5 minutes. The mixing time may be decreased if the ASTM C-94 11.3.3 mixer efficiency tests show that the concrete mixing is satisfactory. The Engineer may require an increase in the minimum mix time if the mixer efficiency test determines that the concrete is not being mixed satisfactorily. The minimum mixing time shall start after the mixer is fully charged. Mixers shall be operated at the speed recommended by the manufacturer as mixing speed. The mixer shall be charged so that a uniform blend of materials reached the mixer through out the charging cycle. Any additional slump water required shall be added to the mixing chamber by the end of the first 25% of the specified mixing time. Mixers shall not be used if the drum is not clean or if the mixing blades are damaged or badly worn

Ribbon mixers: After all solid materials are assembled in the mixer; the mixing time shall be a minimum of 30 seconds and a maximum of 2.5 minutes. The mixing time may be decreased if the ASTM C-94 11.3.3 mixer efficiency tests show that the concrete mixing is satisfactory. The Engineer may require an increase in the minimum mix time if the mixer efficiency test determines that the concrete is not being mixed satisfactorily. The minimum mixing time shall be indicated by an accurate timing device which is automatically started when the mixer is fully charged. Mixers shall be operated at the speed recommended by the manufacturer as mixing speed. The mixer shall be charged so that a uniform blend of

materials reached the mixer through out the charging cycle. After any additional slump water is added to the mixing chamber the mixing shall continue for a minimum of 10 seconds. Mixers shall not be used if the mixer is not clean or if the mixing blades are damaged or badly worn.

Truck Mixers -The capacities and mixing capabilities shall be as defined in ASTM C 94, and each unit shall have an attached plate containing the information described therein. The plate may be issued by the Truck Mixer Manufacturer. The mixer capacity shall not be exceeded, and the mixing speeds shall be within the designated limits. Truck mixers shall be equipped with a reliable reset revolution counter. If truck mixers are used for mixing while in transit, the revolution counter shall register the number of revolutions at mixing speed.

An authorized representative of the concrete producer shall certify that the interior of the mixer drum is clean and reasonably free of hardened concrete, that the fins or paddles are not broken or worn excessively, that the other parts are in proper working order, and that the unit has been checked by the representative within the previous 30 calendar day period to substantiate this certification. The current, signed certification shall be with the unit at all times.

The required mixing shall be between 70 and 90 revolutions. The mixing shall be at the rate designated by the manufacturer and shall produce uniform, thoroughly mixed concrete.

The Engineer may inspect mixer units at any time to assure compliance with certification requirements, and removal of inspection ports may be required. Should the Engineer question the quality of mixing, the Engineer may check the slump variation within the batch. Should the slump variation between two samples taken, one after approximately 20% discharge and one after approximately 90% discharge of the batch, show a variation greater than 3/4 inch (20 mm) or 25% of the average of the two, whichever is greater, the Engineer may require the mixing to be increased, the batch size reduced, the charging procedure be modified or the unit removed from the work.

The practice of adding water on the site shall be discouraged. After the slump of the concrete in the first round of trucks has been adjusted on-site, the amount of water added at the plant shall be adjusted accordingly for that day's work. All additions of water on site shall be approved by the Engineer.

Curing

Apply liquid curing compound in a fine atomized spray to form a continuous, uniform film on the horizontal surface, vertical edges, curbs and back of curbs immediately after the surface moisture has disappeared, but no later than 30 minutes after concrete placement. With approval of the Engineer, the timing of cure application may be adjusted due to varying weather conditions and concrete mix properties.

The cure system shall be on site and tested prior to concrete placement.

Apply a curing compound at a rate of application not less than 2 gallons per 25 square yards. The Contractor shall keep the material thoroughly mixed per the Manufacturer's recommendations. The curing compound shall not be diluted.

The finished product shall appear as a uniformly painted solid white surface. Areas exhibiting a blotchy or spotty appearance shall be recoated immediately.

COMPLIANCE WITH STANDARDS

The Engineer will review and approve all material test reports and mix designs supplied by the Contractor before any placement of concrete. The Engineer will visually inspect the placed concrete and review the concrete test reports prior to final acceptance.

Acceptance sampling and testing will be performed using the sampling method and testing option selected by the Engineer. Acceptance testing will be performed at the frequency specified by the Engineer. Quality control measures to insure job control are the responsibility of the Contractor. The Engineer's testing and/or test results will not relieve the Contractor from his/her responsibilities to produce, deliver, and place concrete that meets all project requirements. The Engineer's test results are for acceptance purposes only.

If the results of the testing are not in compliance with the project specifications, the Engineer shall determine appropriate corrective action(s). Time extensions will not be granted to the Contractor during the time that the Engineer is determining the necessary corrective actions.

If, in the Engineer's judgment, the rejected material must be replaced, the material in question will be removed and replaced at the Contractor's sole expense. The removal costs will be deemed to include all relevant and associated costs including, but not limited to; re-mobilization, traffic control, re-grading the aggregate base course, if required, placement of material meeting the project specifications, and all other expenses. Time extensions will not be granted to the Contractor for any required repair work to meet the requirements of this specification.

If the Engineer decides that the material in question can remain in place, an adjustment to the contract unit price(s) may be made of up to 100% of the bid price(s) for the affected items of work.

MEASUREMENT AND PAYMENT

The cost associated with complying with the requirements as described herein, including any required remedial action(s), shall be included in the cost of other items of work and shall not be paid for separately.

CITY OF ANN ARBOR
DETAILED SPECIFICATION
FOR
CONCRETE SIDEWALKS, SIDEWALK RAMPS, AND DRIVEWAY APPROACHES

AA:JN

1 of 2

04/30/15

a. Description. This work shall consist of constructing concrete sidewalks, sidewalk ramps, or driveway approaches of the types as indicated on the plans in accordance with attached details, and as directed by the Engineer. All sidewalks, ramps and approaches shall be constructed of high early concrete. All sidewalks and ramps shall contain fibermesh reinforcement. All work shall be in accordance with sections 801 and 803 of the Michigan Department of Transportation (MDOT) 2012 Standard Specifications for Construction, and as specified herein.

b. Materials. The materials shall meet the requirements as specified sections 801 and 803 of the MDOT 2012 Standard Specifications for Construction and as required herein. The concrete mixture shall be Grade P-NC (658 lbs/yd³ cement content) as specified in section 601 of the MDOT 2012 Standard Specifications.

Fibermesh reinforcement shall consist of polypropylene fibrillated fibers added at the rate of 1.5 pounds per cubic yard to the concrete. The fibers shall meet the requirements of ASTM C1116-89 "Specification for Fiber Reinforced Concrete and Shotcrete" Classification 4.1.3 Type III. The concrete shall be thoroughly mixed for a minimum of 5 minutes after the addition of the fibers to assure uniform distribution throughout the concrete.

All concrete mixtures shall contain 6AA coarse aggregates which are either natural or limestone and meet the requirements of section 902 of the MDOT 2012 Standard Specifications for Construction.

It shall be the Contractor's sole responsibility to propose specific concrete mix designs which meet the requirements of this Detailed Specification.

c. Construction Methods. The Contractor is responsible to construct all sidewalks, sidewalk ramps, curbs, and all other concrete items within ADAAG compliance. All sidewalk and curb ramps must be constructed in accordance with MDOT Standard Plan Series R-28.

The Contractor shall trim, place, and compact granular material as needed to construct new concrete items and to relocate existing concrete items to their new elevations and locations.

Where concrete is to be placed, it shall be placed on a minimum of 4 inches of Granular Material Class II compacted to 95% of its maximum dry density. In the downtown area, all sidewalk and ramps shall be placed on a minimum of 8 inches of Granular Material Class II compacted to 95% of its maximum dry density.

Where indicated on the plans, the Contractor shall horizontally sawcut curbs to provide openings for sidewalk ramps. The Engineer shall define the extent of sawcutting both horizontally and vertically. This work will not be paid for separately, but shall be included in the corresponding price of the ADA ramp to be placed.

All sidewalk ramps shall be installed with detectable warning units. Reference the Detailed Specification entitled "Detectable Warning Surface" for additional requirements.

d. Measurement and Payment. The completed work, as described, will be measured and paid for at the contract unit prices respectively for the following pay items:

<u>Pay Item</u>	<u>Pay Unit</u>
Sidewalk, Conc, ___ inch	Square Foot
Sidewalk Ramp, Conc, ___ inch.....	Square Foot
Driveway, Nonreinf Conc, ___ inch	Square Yard

The above items will be measured by area in square feet and be paid for at their respective contract unit price, which price shall be payment in full for all labor, equipment and material needed to accomplish this work.

The unit price for "Sidewalk Ramp, Conc, ___ inch" shall also include all costs associated with sawcutting curbs to provide openings for sidewalk ramps as indicated on the plans.

Where the Engineer directs the use of high early strength concrete for pay items that are not specifically designated to use Grade "P-NC" concrete, the additional cement shall be paid for separately. No additional payment will be made for cement for pay items that are designated to use Grade "P-NC." concrete.

The furnishing and adding the fibermesh reinforcement materials shall also be included in the contract unit price for the respective sidewalk and ramp pay items.

Detectable warning units shall be paid for in accordance with the Detailed Specification for Detectable Warning Surface.

**DETAILED SPECIFICATION
FOR
DETECTABLE WARNING SURFACE**

DESCRIPTION

This work shall consist of furnishing and installing cast in place detectable warning units in compliance to the Americans with Disability Act (ADA). All work shall be in accordance with the current version of MDOT Standard Detail R-28.

MATERIALS AND CONSTRUCTION METHODS

The detectable warning tiles shall be ceramic cement or composite polymer concrete (CRC), colored as Federal Number 22144 (frequently referred to as "Colonial Red" or "Brick Red"). The detectable warning tiles shall meet the following dimensions and tolerances:

1. Dimensions: Cast In Place Detectable/tactile Warning Surface Tiles shall be held within the following dimensions and tolerances:

Length: 24"

Width: The full width of the approaching walk (60" for typical sidewalk)

Depth: 1.375 (1-3/8") (+/-) 5% max.

Face Thickness: 0.1875 (3/16") (+/-) 5% max. Warpage of Edge: 0.5% max.

Embedment Flange Spacing: shall be no greater than 3.1"

2. Water Absorption of Tile when tested by ASTM D 570-98 not to exceed 0.05%.
3. Slip Resistance of Tile when tested by ASTM C 1028-96 the combined Wet and Dry Static Co-Efficients of Friction not to be less than 0.80 on top of domes and field area.
4. Compressive Strength of Tile when tested by ASTM D 695-02a not to be less than 28,000 psi.
5. Tensile Strength of Tile when tested by ASTM D 638-03 not to be less than 19,000 psi.
6. Flexural Strength of Tile when tested by ASTM D 790-03 not to be less than 25,000 psi.
7. Chemical Stain Resistance of Tile when tested by ASTM D 543-95 (re approved 2001) to withstand without discoloration or staining - 10% hydrochloric acid, urine, saturated calcium chloride, black stamp pad ink, chewing gum, red aerosol paint, 10% ammonium hydroxide, 1% soap solution, turpentine, Urea 5%, diesel fuel and motor oil.
8. Abrasive Wear of Tile when tested by BYK - Gardner Tester ASTM D 2486-00 with reciprocating linear motion of $37 \pm$ cycles per minute over a 10" travel. The abrasive medium, a 40 grit Norton Metallite sand paper, to be fixed and leveled to a holder. The combined mass of the sled, weight and wood block is to be 3.2 lb. Average wear depth shall not exceed 0.060 after 1000 abrasion cycles when measured on the top surface of the dome representing the average of three measurement locations per sample.
9. Resistance to Wear of Unglazed Ceramic Tile by Taber Abrasion per ASTM C501-84 (re approved 2002) shall not be less than 500.
10. Fire Resistance of Tile when tested to ASTM E 84-05 flame spread shall be less than 15.
11. Gardner Impact to Geometry "GE" of the standard when tested by ASTM D 5420-04 to have a mean failure energy expressed as a function of specimen thickness of not less than 550 in. lbf/in. A failure is noted when a crack is visible on either surface or when any brittle splitting is observed on the bottom plaque in the specimen.
12. Accelerated Weathering of Tile when tested by ASTM G 155-05a for 3000 hours shall exhibit the following result - $\Delta E < 4.5$, as well as no deterioration, fading or chalking of surface.
13. Accelerated Aging and Freeze Thaw Test of Tile and Adhesive System when tested to ASTM D 1037-99 shall show no evidence of cracking, delamination, warpage, checking,

- blistering, color change, loosening of tiles or other detrimental defects.
14. Salt and Spray Performance of Tile when tested to ASTM B 117-03 not to show any deterioration or other defects after 200 hours of exposure.
 15. AASHTO HB-17 single wheel HS20-44 loading "Standard Specifications for Highways and Bridges". The Cast In Place Tile shall be mounted on a concrete platform with a ½" airspace at the underside of the tile top plate then subjected to the specified maximum load of 10,400 lbs., corresponding to an 8000 lb individual wheel load and a 30% impact factor. The tile shall exhibit no visible damage at the maximum load of 10,400 lbs.
 16. Embedment flange spacing shall be no greater than 3.1" center to center spacing as illustrated on the product Cast In Place drawing.

CONSTRUCTION METHODS

The contractor shall follow manufacturer specifications for installation, except where they conflict with MDOT Standard Detail R-28- F (version in place at time of the bid letting).

MEASUREMENT AND PAYMENT

The completed work as measured for this item of work will be paid for at the Contract Unit Prices for the following Contract (Pay) Item:

PAY ITEM

Detectable Warning Surface

PAY UNIT

Square Foot

The unit price for this item of work shall include all labor, material, and equipment costs to perform all the work specified in the Standard Specifications and as modified by this Detailed Specification.

DETAILED SPECIFICATION
FOR
CAST IRON DETECTABLE WARNINGS

AA:JN

1 of 1

2/4/16

a. Description. This work consists of constructing and/or reconstructing sidewalk ramps with cast iron detectable warning surfaces at the specified location(s). Complete this work according to the standard specifications and Standard Plan R-28 Series, except as modified herein.

b. Materials. Use detectable warning surfaces that provide tactile and visual warning and contrast visually with adjacent walking surfaces, either light-on-dark or dark-on-light. Provide cast iron detectable warning surfaces that conform to the dimensions shown on Standard Plan R-28 Series. Select one of the following products, or provide an approved equal, for this project.

Neenah Foundry

2121 Brooks Ave
Neenah, WI 54956
Phone: 920-725-7000
Product Name: NF Detectable Warning Plates

East Jordan

301 Spring Street
East Jordan, MI 49727
Phone: 800-874-4100
Product Name: EJ Cast Iron Detectable Warning Plate

Provide all detectable warning surfaces from the same manufacturer unless otherwise approved by the Engineer.

c. Construction. Construct sidewalk ramps according to subsection 803.03 of the Standard Specifications for Construction and Standard Plan R-28 Series, except that the ramps must be the thickness as shown on the plans. Install detectable warning surfaces according to the manufacturer's instructions and Standard Plan R-28 Series.

When replacing gutters in addition to sidewalk ramps, transition the gutter cross section in advance of the sidewalk ramp to meet the dimensions and profile in Standard Plan R-28-series.

d. Measurement and Payment. The completed work, as described, will be measured and paid for at the contract unit price using the following pay item:

Pay Item	Pay Unit
Detectable Warning Surface, Cast Iron	Square Foot

Detectable Warning Surface, Cast Iron will be measured in place by the area of detectable warning material installed at specified locations. Payment includes all labor, materials, and equipment to install detectable warning surface.

All concrete work required for this work will be measured and paid for as specified elsewhere in this contract.

SPECIAL PROVISION
FOR
PROTECTIVE FENCING

AA:MGN

1 of 2

02/07/14

a. Description.- This work shall consist of taking all reasonable measures to protect all existing trees and vegetation designated to remain and be protected within the project limits and the construction influence area, in accordance with Sections 201.03.A.2 and Section 808 of the Michigan Department of Transportation 2012 Standard Specifications for Construction, except as specified herein. The work shall also consist of installing protective fencing at the limits of the construction area as shown on the plans or in areas directed by the Engineer.

b. Materials. - Fabric shall be orange, vinyl, snow fence material, 4 feet tall. Posts shall be 6 foot long, T-shaped, metal posts or 2 inch square hardwood stakes

c. Means and Methods of Protection.- Install protective fence at the limits of the construction area as shown on the plans or as directed by the Engineer.

The Contractor shall not operate equipment within the tree protection fence of any existing tree without the approval of the Engineer.

Construction material, supplies, or equipment shall not be stockpiled or stored within the limits of the tree protection fence.

Vehicles and personnel are not permitted within the limits of the tree protection fence.

The Contractor shall not attach chains, cables, ropes, nails, or other articles to any tree at any time.

Any damage to trees owned by the City of Ann Arbor or other trees designated to be protected due to the Contractor's activities or activities of the Contractor's subcontractors or suppliers shall be repaired under the direction of the City Forester by an approved forestry specialist. The costs of these repairs shall be the sole responsibility of the Contractor.

Should the Contractor's operations damage a plant's roots to the extent that it must be removed, the Contractor shall either replace the plant with a commensurate number of plants, 2½" caliper trees of the species as determined by the City, or compensate the City of Ann Arbor for the cash value of the plant or tree as determined by the City of Ann Arbor's Forester. The City of Ann Arbor shall be solely responsible for determining which compensation method is used.

The City Forester shall supervise the replacement of any trees at the sole expense of the Contractor.

Remove tree protection fence when directed by the Engineer.

d. Measurement and Payment.- The completed work shall be paid for at the contract unit price for the following contract items (pay items):

<u>Contract Item (Pay Item)</u>	<u>Pay Unit</u>
Protective Fence.....	Foot

“Protective Fence” will be measured in length, by feet of protective fence used, and will be paid for at the contract unit price which shall be payment in full for all labor, materials, and equipment needed to accomplish this work. No additional payment will be made for maintenance or reinstallation of fence during the construction period.

**DETAILED SPECIFICATION
FOR
PAVEMENT MARKINGS**

1 of 2

a. Description This work consists of providing and placing permanent pavement markings in accordance with the Michigan Manual on Uniform Traffic Control Devices. Provide markings, legends, symbols, spacing, and dimensions that conform to the plans, the City of Ann Arbor Standard Specifications, 2012 Michigan Department of Transportation Standard Specifications for Construction, and as specified herein.

b. Materials Provide materials in accordance with Sections 811 and 920 of the 2012 Michigan Department of Transportation Standard Specifications for Construction. Provide the Material Safety Data Sheets to the Engineer for required materials and supplies. Dispose of unused material and containers in accordance with the Federal Resource Conservation Recovery Act (RCRA) of 1976 as amended, and 1994 PA 451, Part 111 Hazardous Waste Management. Provide samples of permanent pavement marking materials upon request.

Thermoplastic materials provided shall be in accordance with Section 920 Sprayable Thermoplastic Pavement Marking Material

c. Construction Methods The preparation and placement of permanent pavement markings shall conform to Section 811 of the 2012 MDOT Standard Specifications for Construction, the City of Ann Arbor Standard Specifications, the plans, and as specified herein.

All permanent markings are to be recessed in accordance with Detailed Specifications included in the contract documents.

d. Measurement and Payment The measurement and payment for thermoplastic pavement markings shall be in accordance with Section 811.04 of the 2012 MDOT Standard Specifications for Construction, the City of Ann Arbor Standard Specifications, the plans, and as specified herein.

The unit prices for these items of work shall include all labor, material, and equipment costs to perform all the work specified in the Sections 811 and 920 of the 2012 MDOT Standard Specifications and as modified by this Detailed Specification.

The completed work as measured for these items of work will be paid for at the Contract Unit Price for the following Contract (Pay) Items:

PAY ITEM

PAY UNIT

Pavt Mrkg Hot-Applied Thermoplastic __ inch White	Lineal Foot
Pavt Mrkg Hot-Applied Thermoplastic __ inch Yellow	Lineal Foot
Pavt Mrkg Hot-Applied Thermoplastic __ inch Crosswalk	Lineal Foot
Pavt Mrkg Hot-Applied Thermoplastic __ inch Stop Bar	Lineal Foot
Pavt Mrkg Overlay Cold Plastic White Only	Each
Pavt Mrkg Overlay Cold Plastic White _____ Arrow	Each
Pavt Mrkg Overlay Cold Plastic White Bike Symbol	Each
Pavt Mrkg Overlay Cold Plastic White Bike Sharrow	Each
Recessed Pavt Mrkg, Thermoplastic, Parking	Each

**DETAILED SPECIFICATION
FOR
PAVEMENT MARKINGS**

1 of 2

All work indicated herein shall be included in the unit prices for the above pay items and shall include all labor, materials and equipment required to complete the work.

The item Recessed Pavt Mrkg, Thermoplastic, Parking includes all materials in addition to recessing the pavement marking as detailed elsewhere in this contract.

**DETAILED SPECIFICATION
FOR
RECESSED PAVEMENT MARKINGS**

a. Description. This work consists of providing all equipment and labor required to prepare (grooving) the pavement surface for recessed longitudinal and transverse lines, and legend, symbol and arrow pavement markings in accordance with section 811 of the Standard Specifications for Construction, the plans, and this special provision.

b. Materials. None specified.

c. Construction. Install a recess (groove) in accordance with the recessed pavement marking material manufacturer's installation instructions. Ensure all recessing configurations are in accordance with the *Michigan Manual of Uniform Traffic Control Devices* and the Pavement Marking Standards.

1. Grooving Concrete and Hot Mix Asphalt Pavement. If there are no markings on the pavement, paint a temporary tracer line (with no beads) exactly where the permanent markings will be placed. Use these lines as a template for the grooving operation.

Use equipment and methods approved by the manufacturer of the recessed pavement marking material to be recessed for forming grooves in pavement surfaces. Dry-cut the grooves in a single pass using stacked diamond cutting heads on self-vacuuming equipment capable of producing a finished groove ready for pavement marking material installation.

Ensure that the bottom of the groove has a fine corduroy finish. If a coarse tooth pattern results, increase the number of blades and decrease the spaces on the cutting head until the required finish is achieved.

2. Groove Dimensions. Ensure grooves for recessed pavement markings are in accordance with the following:

Longitudinal Markings

Groove Width: Material width +1 inch, ($\pm 1/8$ inch)
Groove Depth: As recommended by the manufacturer, (± 5 mils)
Groove Position: Center/Lane Lines: 2 inches from joint line, ($\pm 1/8$ inch)
Edge Lines: On lane, 2-4 inches in from the joint line, ($\pm 1/8$ inch)
Edge Lines for 14 foot paved lanes: as directed by the Engineer

Transverse Markings

Groove Width: Material width +1 inch, ($\pm 1/8$ inch)
Groove Depth: As recommended by the manufacturer, (± 5 mils)
Groove Position: In the exact location where the transverse marking (crosswalk or stop bar) will be placed.

Special Markings

Groove Width: Material width +1 inch, ($\pm 1/8$ inch)
Groove Depth: As recommended by the manufacturer, (± 5 mils)
Groove Position: In the exact location where the symbol, legend or arrow will be placed.

3. Placing Recessed Pavement Markings. Place the pavement marking material in the grooves within 24 hours of the grooves being made. Ensure the grooves are clean and dry prior to placing pavement marking material. Locate the groove so the entire marking can be placed within the groove.

d. Measurement and Payment. The completed work, as described, will be measured and paid for at the contract unit price using the following pay items:

Pay Item	Pay Unit
Recessing Pavement Markings Longitudinal	Foot
Recessing Pavement Markings Transverse	Square Foot
Recessing Special Pavement Markings	Square Foot

Recessing Pavement Markings Longitudinal and Recessing Pavement Markings Transverse include placing the temporary tracer line (with no beads), when required, and all work as described in this special provision.

Pavement marking materials, including retroreflective pavement marking required for traffic control, will be paid for separately using the appropriate pay items.

**DETAILED SPECIFICATION
FOR
MINOR TRAFFIC CONTROL MAXIMUM**

DESCRIPTION

The work of Minor Traffic Control shall include, but not be limited to:

- The operation of additional signs furnished by the City;
- Coordinating with the City to have meter heads bagged, or removed and reinstalled;
- Maintaining pedestrian traffic, including furnishing and installing sidewalk closed/detour signs and Type II pedestrian barricades;
- Temporarily covering existing signs as directed;
- Any and all other miscellaneous and/or incidental items which are necessary to properly perform the work.

The Contractor shall maintain vehicular and pedestrian traffic during the work by the use of channelizing devices, and signs as necessary, as directed by the Engineer, and in accordance with MMUTCD.

Typical applications for maintaining pedestrian traffic in accordance with the MMUTCD are included in this detailed specification. In addition to the signing and barricades shown in the following details, furnish, place, maintain, and operate Type II Pedestrian Barricades as a hard closure at the limits of construction of the sidewalk or ramps. Type II Pedestrian Barricades should also be placed at the receiving ramp to be closed to pedestrian traffic. It is anticipated that eight barricades will be required for each area of construction.

MEASUREMENT AND PAYMENT

This item of work will be paid for on a pro rata basis at the time of each progress payment. Measurement will be based on the ratio between work completed during the payment period and the total contract amount. When all of the work of this Contract has been completed, the measurement of this item shall be 1.0 Lump Sum.

The completed work as measured for this item of work will be paid for at the Contract Unit Price for the following Contract (Pay) Item:

PAY ITEM

Minor Traffic Control Maximum

PAY UNIT

Lump Sum

The unit price for this item of work shall include all labor, material, and equipment costs to perform all the work specified in the Standard Specifications and as modified by this Detailed Specification.



Figure 6H-28. Sidewalk Detour or Diversion (TA-28)

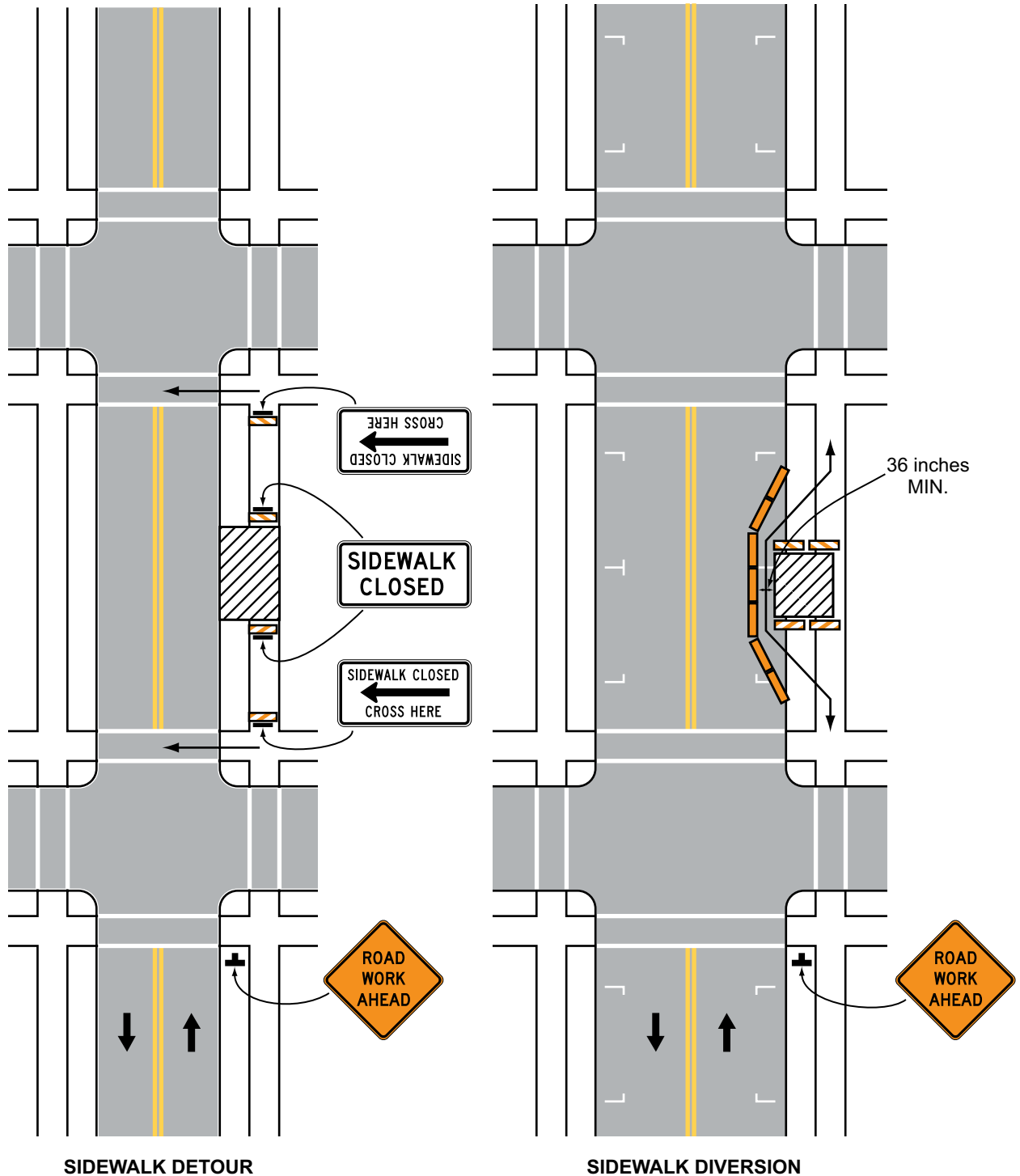

Typical Application 28

Note: See Tables 6H-2 and 6H-3 for the meaning of the symbols and/or letter codes used in this figure.

Figure 6H-29. Crosswalk Closures and Pedestrian Detours (TA-29)

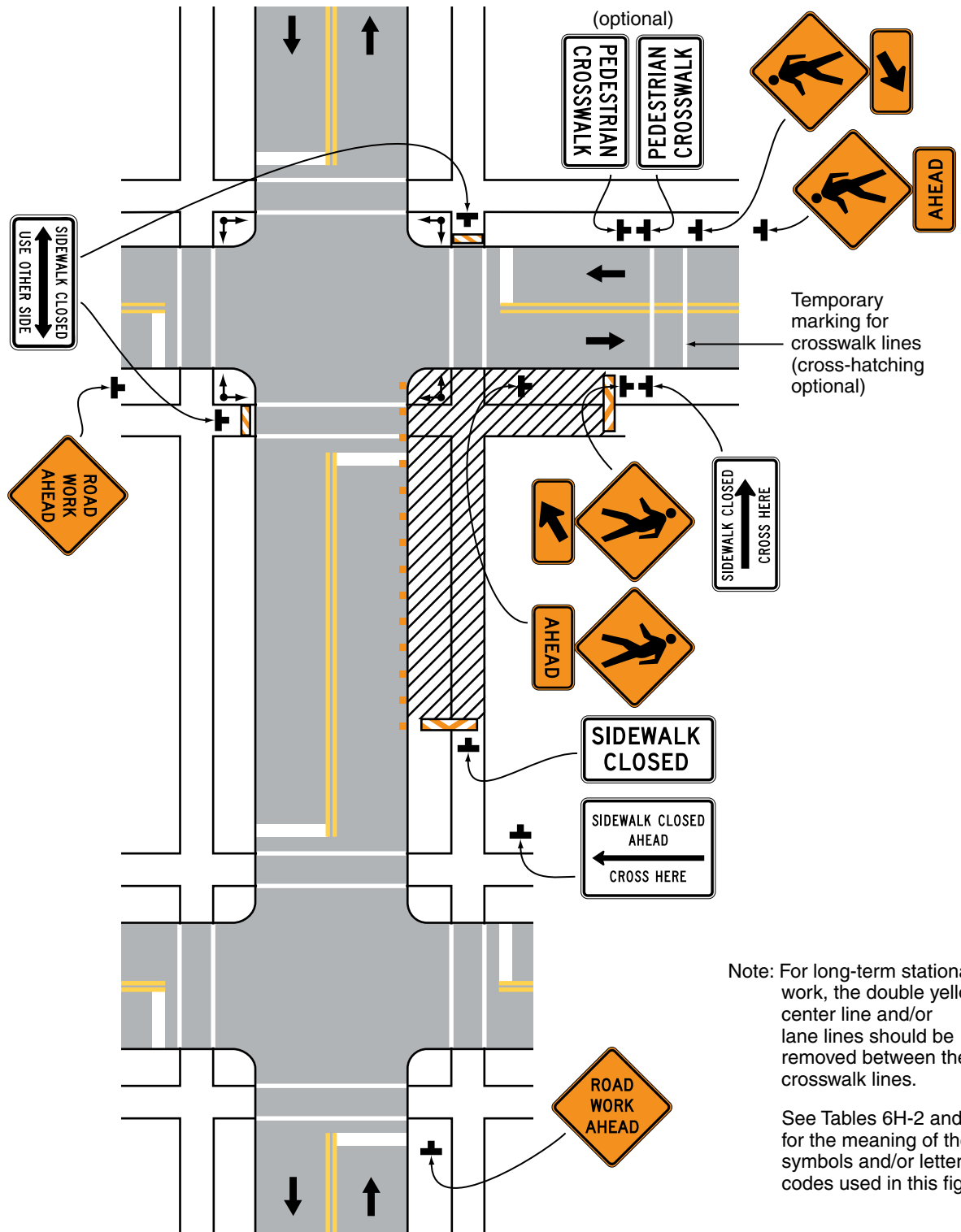

Typical Application 29

Note: For long-term stationary work, the double yellow center line and/or lane lines should be removed between the crosswalk lines.

See Tables 6H-2 and 6H-3 for the meaning of the symbols and/or letter codes used in this figure.

DETAILED SPECIFICATION
FOR
TEMPORARY PEDESTRIAN TYPE II BARRICADE

OFS:RAL

1 of 2

APPR:CAL:CT:10-30-15

a. Description. This work consists of furnishing, installing, maintaining, relocating, and removing a 4-foot wide temporary pedestrian Type II barricade section as identified in the proposal or on the plans. Use temporary pedestrian Type II barricades to close non-motorized facilities including sidewalks, bicycle paths, pedestrian paths, and shared use paths that are not part of the roadway. One pedestrian Type II barricade is defined as a 4-foot barricade section including all supports, ballast, and hardware. Damaged temporary pedestrian barricades must be replaced as directed by the Engineer.

b. Materials. Provide a temporary pedestrian Type II barricade that meets the requirements of *National Cooperative Highway Research Program Report 350 (NCHRP 350)* or *Manual for Assessing Safety Hardware (MASH)*, in addition to meeting the following requirements:

1. Provide 4-foot wide barricade sections designed to interconnect to ensure a continuous *Americans with Disabilities Act (ADA)* compliant tactile barrier. Ensure the connection includes provisions to accommodate non-linear alignment as well as variations in elevation at the installation area.

2. Ensure the top surface of the barricade is designed to function as a hand-trailing edge, and has a height between 32 and 38 inches. Ensure the lower edge of the barricade is no more than 2 inches above the surface of the non-motorized facility. Ensure the top edge of the bottom rail of the barricade is a minimum of 8 inches above the surface of the non-motorized facility. The barricade may have a solid continuous face. Finally, all features on the front face of the barricade (the face in contact with pedestrians) must share a common vertical plane.

3. Equip both sides of the barricade with alternating orange and white vertical stripes of reflective sheeting. If the barricade consists of two rails, ensure both rails are sheeted. If the barricade has a solid face, two 6-inch bands of sheeting will be required; one near the top and one near the bottom of each section. Ensure this sheeting meets or exceeds the requirements of *ASTM D 4956* Type IV sheeting. Ensure the stripes of reflective sheeting are aligned vertically.

c. Construction. Construct the temporary pedestrian Type II barricade in accordance with the manufacturer's recommendations, ADA, the plans, and the following requirements:

1. Install the barricade at the 'hard closure' of each area of sidewalk replacement or closure, as shown on the plans and as directed by the Engineer. Interconnect all barricade sections using hinge components if necessary to ensure a continuous detectable edge for the entire installation. Ensure the barricade is ballasted according to the manufacturer's recommendations to ensure stability during wind events and contact with pedestrians.

2. When the barricade is installed near motor vehicle traffic, ensure reflective sheeting is visible to motorists.

3. When pedestrian Type II barricades are used to close a non-motorized facility, ensure a sufficient number of 4-foot sections are used to block the entire width of the facility.

The barricade may extend outside the edge of the non-motorized facility but must not be less than the full width of the facility.

4. If sections of multiple colored barriers are used (i.e. safety orange and white) install the sections such that the colors alternate to increase conspicuity.

5. Ensure pedestrian Type II barricades are not used to close a motor vehicle facility. Ensure these barricades are not used to guide pedestrian traffic on a motor vehicle facility in the presence of active traffic. This prohibition includes bicycle/shared use lanes or shoulders in the presence of active traffic.

d. Measurement and Payment. The completed work, as described, will be included in the item "Minor Traffic Control, Maximum \$", which includes all labor, equipment, and materials to furnish, install, maintain, relocate, and remove one 4-foot barricade section. This includes all rails, supports, ballast, hinge points, reflective sheeting, and miscellaneous hardware needed to install and maintain a barricade section.

CITY OF ANN ARBOR
DETAILED SPECIFICATION
FOR
SLOPE RESTORATION

AA:JN

1 of 2

1/28/16

a. Description. This work consists of preparing all manicured lawns and slopes designated for slope restoration on the plans or by the Engineer, and applying topsoil, fertilizer, seed, and mulch to those areas. Turf establishment shall be in accordance with section 816 of the Michigan Department of Transportation (MDOT) 2012 Standard Specifications for Construction and Standard Plan Series R-100, except as modified herein or otherwise directed by the Engineer.

b. Materials. The materials and application rates specified in sections 816 and 917 of the MDOT 2012 Standard Specifications for Construction apply unless modified by this special provision or otherwise directed by the Engineer.

1. Topsoil Surface: Place **4 inches** of topsoil in area disturbed areas to be restored. Topsoil shall be free of all stones one inch in diameter or greater.
2. Turf Seed Mixture: Use seed mixture type THM (Turf Loamy to Heavy) with an application rate of 220 lb/acre.
3. Chemical Fertilizer Nutrient: Use Class A fertilizer with an application rate of 176 lb/acre.
4. The erosion control blanket used shall be CN125BN as manufactured by North American Green, or equivalent. The coconut fiber erosion control blanket shall have the following properties:

Matrix: 100% coconut fiber. (0.50 lbs/square yard)

Netting: Top-Leno woven 100% biodegradable organic jute fiber (9.30 lbs/1000sft. approx. wt.) Bottom – 100% biodegradable organic jute fiber (7.7 lbs/1000 sft approximate weight.)

Thread: Biodegradable.

Width: 6.67ft. (+/- 5%)

Length: 108 ft. (+/- 5%)

Weight: 52.22 lbs. (+/-10%)

Area: 80 syd.

Stitch Spacing for all rolls: 1.50 inches.

Erosion control blanket shall be manufactured with a colored line or thread along outer edges to ensure proper material overlapping. Manufacturer's recommended fastening pattern must be clearly marked on blanket to insure proper anchorage to soil. Biodegradable fasteners supplied by manufacturer based on type of installation required. Installation instructions must be included with each delivery of erosion control blankets.

c. Construction. Construction methods shall be in accordance to subsection 816.03 of the MDOT 2012 Standard Specifications for Construction. Begin this work as soon as possible after final grading of the areas designated for slope restoration but no later than the maximum time frames stated in subsection 208.03 of the Standard Specifications for Construction. It may be necessary, as directed by the Engineer, to place materials by hand.

Prior to placing topsoil, shape, compact and assure all areas to be seeded **are weed free**. Place topsoil to the minimum depth indicated above, to meet proposed finished grade. Remove any stones greater than or equal to 1 inch in diameter. If the area being restored requires more than the minimum depth of topsoil to meet finished grade, this additional depth must be filled using topsoil. Furnishing and placing this additional material is included in this item of work.

Topsoil shall be **weed and weed seed free** and friable prior to placing seed. Remove all stones from the topsoil greater than 1 inch in diameter. Apply seed mixture and fertilizer to prepared soil surface. Seed shall be incorporated into top 1/2 inch of topsoil.

In general, all edges of parallel blankets must be staked with approximately 2 inches overlap. When the blankets must be spliced down a slope, place blankets end over end (shingle style) with approximately 6 inches of overlap. Stake through overlapped area approximately 12 inches apart. In general, stake blanket approximately two stakes per square yard using manufacturer's recommended stapling pattern.

Each blanket roll shall be wrapped with a material that will protect it from damage due to shipment, water, sunlight, and contaminants. During storage, blanket rolls shall be elevated off the ground and adequately covered to protect them from construction damage, precipitation, extended ultraviolet radiation, chemicals that are strong acids or bases, flames, excess temperatures, and any other environmental conditions that may damage the physical property values of the blankets.

If erosion control blanket is required in areas where plugs are present, install erosion control blanket after seeding, but prior to plugging.

If an area washes out after this work has been properly completed and approved by the Engineer, make the required corrections to prevent future washouts and replace the topsoil, fertilizer, seed and mulch. This replacement will be paid for as additional work using the applicable contract items.

If an area washes out for reasons attributable to the Contractor's activity or failure to take proper precautions, replacement shall be at the Contractor's expense.

The Engineer will inspect the seeded turf to ensure the end product is well established, weed free, in a vigorous growing condition, and contains the species called for in the seeding mixture. **If areas do not promote growth, the Contractor shall apply new seed at its expense.**

If weeds are determined by the Engineer to cover more than ten percent of the total area of slope restoration, the Contractor shall provide weed control in accordance to subsection 816.03.J of the MDOT 2012 Standard Specifications for Construction. Weed control shall be at the Contractor's expense with no additional charges to the project for materials, labor or equipment.

d. Measurement and Payment. The completed work, as described, will be measured and paid for at the contract unit price for the following pay item:

<u>Pay Item</u>	<u>Pay Unit</u>
Slope Restoration	Square Yard

Slope Restoration shall be performed in all areas disturbed by the Contractor to construct the Project as shown on the plans and as directed by the Engineer. The Contractor will restore areas disturbed by its operations not required by the Project at its own expense.

SPECIAL PROVISION
FOR
ELECTRICAL AND COMMUNICATION HANDHOLES

AA:JN

1 of 2

02/10/14

a. Description.- This work shall consist of furnishing and installing traffic signal handholes and communication handhole assemblies at the locations shown in the Plans, or as directed by the Engineer. All work shall be completed in accordance with the current National Electric Code (NEC), Section 819 of the Michigan Department of Transportation 2012 Standard Specifications for Construction, except as specified herein.

b. Materials.- All materials shall be new and meet the requirements of the current IEEE, NEMA, ANSI Standards as applicable, and as specified herein.

The Contractor shall submit product data sheets for all handholes, covers and other parts for Engineer approval prior to ordering materials. The manufacturer "Quazite Composolite," referenced below, is located in Lenoir City, Tennessee.

12 inch x 18 inch handhole assemblies shall consist of "Quazite Composolite" box. The box shall be #PG1118BA12. The cover shall be, #PG1118HA41, a locking heavy-duty bolt-down type with a logo that reads "Street Lighting." The total depth of the handhole shall be 12 inches.

17 inch x 30 inch handhole assemblies shall consist of two, stacked "Quazite Composolite" boxes. The lower box shall be #PG1730BB18. The upper box shall be #PG1730BA18. The cover shall be, #PG1730HA46, a locking heavy-duty bolt-down type with a logo that reads "Traffic Signal." The total depth of the handhole shall be 36 inches.

24 inch x 36 inch handhole assemblies shall consist of "Quazite Composolite" box. The box shall be #PG2436BA24. The cover shall be, # PG2436HA12, a locking heavy-duty bolt-down type with a logo that reads "Street Lighting." The total depth of the handhole shall be 24 inches.

Provide Granular Material, Class II as detailed elsewhere in these contract documents.

c. Methods of Construction.- Handholes shall be placed at all junctions of traffic signal or electrical conduit, and as shown on the plans. Maximum distance between any two handholes shall be as shown on the Plans, but in no case shall exceed 500 feet.

Place foundation material consisting of 4 inches of MDOT Class II sand compacted to 95% of its maximum unit weight.

Set the handhole or stacked units to the proper depth and elevation.

Connect handholes to new and existing conduits, whether shown on the plans or not. All conduits shall be connected to the handholes in accordance with the latest revision of Article 346 of the National Electrical Code (NEC).

Backfill around the perimeter of the handhole with MDOT Class II material compacted to 95% of its maximum unit weight.

d. Measurement and Payment.- The completed work shall be paid for at the contract unit price for the following contract items (pay items):

SPECIAL PROVISION
FOR
ELECTRICAL AND COMMUNICATION HANDHOLES

AA:JN

2 of 2

02/10/14

<u>Contract Item (Pay Item)</u>	<u>Pay Unit</u>
Handhole Assembly, 12 inch x 18 inch.....	Each
Handhole Assembly, 17 inch x 30 inch.....	Each
Handhole Assembly, 24 inch x 36 inch.....	Each

Handhole Assembly, ___ inch x ___ inch shall be paid for at their contract unit prices and shall include all labor, equipment, and materials to complete the work as specified herein.

The pay item shall also include the excavation and disposal of materials, furnishing, installing and compacting MDOT Class II sand, and all work related to connecting handholes to new and existing conduits, whether shown on the plans or not.

CITY OF ANN ARBOR
DETAILED SPECIFICATION
FOR
WATER MAIN AND APPURTENANCES

AA:JN

1 of 19

1/28/16

a. Description. The Contractor shall furnish all labor, equipment, pipe, valves, fittings, restrained-joint pipe, restrained-joint gaskets, special gaskets as detailed on the plans and in the specification, polyethylene wrap, blow-off assemblies, fire hydrant, fire hydrant extensions, supplemental lighting towers, and all other materials necessary to complete the work as shown on the Plans, as detailed in this Detailed Specification, and as directed by the Engineer.

All water main installation and testing procedures shall be performed in accordance with the project plans, the requirements of this Detailed Specification, and as directed by the Engineer.

b. Materials.

1. Submittals. Prior to beginning construction, the Contractor shall submit the following:
 - A. Product data on all ductile iron pipe, valves, fittings, and hydrants.
 - B. Manufacturer's certifications on all pipe, fittings, and precast concrete units indicating that all materials meet the minimum requirements of these specifications.
 - C. Information on equipment and methods to be used for flushing, chlorination, pressure and bacteriological testing.
2. General Specifications.
 - A. Cast Ductile Iron Pipe and Fittings:

Cast ductile iron pipe shall be Iron Grade 60-42-10 and meet the requirements of ANSI/AWWA C151/A21.51 in all respects; with standard thickness cement mortar lining and asphaltic seal coat in accordance with ANSI/AWWA C104/A21.4; and, coated outside with an asphaltic coating in accordance with ANSI/AWWA C151/A21.51. 100% of the ferrous metals used in the manufacture of cast ductile iron pipe shall be recycled from scrap and other sources. All pipe shall be Pressure Class 350 (Table 50.5 ANSI/AWWA C150/A21.50), or Thickness Class 50 (Table 50.15, ANSI/AWWA C150/A21.50). Ductile iron pipe crossing under a railroad shall be thickness Class 56.

Cast ductile iron river crossing pipe shall be Clow Corp. "F-141 River Crossing Pipe", U.S. Pipe "USIFLEX Boltless Flexible Joint Pipe" or equal approved by the Engineer, and shall be thickness Class 56 minimum. The pipe shall have a boltless flexible joint of the ball and socket type, and be designed for, and rated at, a minimum interior working water pressure of 250 psi.

Restrained joint pipe, where called for on the Plans, shall be factory manufactured by the installation of retainer weldment and ductile iron locking segments or rings. Restrained joint pipe shall be TR-Flex restrained joint pipe manufactured by U.S. Pipe, Lok-Ring

joint pipe manufactured by American Ductile Iron Pipe, or equal as approved by the Engineer.

Cast ductile iron fittings shall be push-on joint, unless otherwise specified (with the exception of solid sleeves and fire hydrants which shall be mechanical joint), meeting the requirements of ANSI/AWWA C110/A21.10 for short body cast iron fittings. Fittings shall have a cement mortar lining and asphaltic seal coat in accordance with ANSI/AWWA C104/A21.4 and ANSI/AWWA C110/A21.10. The outside of all fittings shall have an asphaltic coating in accordance with ANSI/AWWA C110/A21.10.

Solid sleeves shall be long-pattern sleeves.

B. Gate Valves and Gate Valve Boxes:

All gate valves shall be resilient seated meeting the requirements of AWWA C509. All valves shall be of the push-on joint type, unless used on tapping sleeve assemblies, or noted otherwise on the plans. The valves supplied shall be:

- (1) Metroseal 250 Resilient Seated Gate Valve as manufactured by U.S. Pipe & Foundry Company
- (2) U. S. Pipe and Foundry Tyton Joint, Resilient Wedge Seated Gate Valve, meeting the requirements of AWWA C 509, AWWA C550, and ASTM D 2794
- (3) American Flow Control, Series 2500, Single Resilient Wedge
- (4) East Jordan Iron Works FlowMaster Resilient Wedge Valve
- (5) Mueller Series, 4" through 12", A-2360-38, Resilient Wedge – SL x SL
- (6) Tyler Series DRS 250-22 Double Resilient Wedge

All valves shall come equipped with a two-inch square operating nut, opening right.

Valve Boxes shall be Tyler 6860 Buffalo type, Size D, screw-type, 3 piece, 5-1/4 inch shaft and a No. 6 Base for a valve 8 inches or less and a No. 8 base for 10 and 12 inch valves.

C. Gate Valve Wells:

Pre-cast reinforced concrete bases, bottom sections, manhole risers, grade adjustment rings, concentric cones, eccentric cones, and flat-slab tops shall conform to the requirements of ASTM C-478. Joints on precast gate wells shall meet the requirements of ASTM C-443, rubber O-ring gasket.

Flat-slab top, pre-cast, gate wells shall be designed to accommodate HL-93 Modified Live Load requirements as determined by a Professional Engineer licensed by the State of Michigan, regardless of where they are to be installed. For the purposes of design, a HL-93 Modified Live Load shall consist of 1.2 times the design truck or 1.2 times a single 60 kip load, whichever produces the greater stresses.

D. Fire Hydrants:

Fire hydrants shall be East Jordan Iron Works Model 5-BR Water Master BR 250 with traffic flange; American Flow Control 5-1/4" Pacer, WB 67-250; or, Waterous Model TCV-5 with traffic flange. All fire hydrants shall have the following features: a 6 inch mechanical joint pipe connection, ANSI/AWWA C111/A21.11; two 2-1/2 inch National Standard hose connections; one 4 inch Stortz pumper connection; 1-3/8 inch pentagon operating and cap nuts (1-3/8 in. point-to-flat at top; 1-7/16 in. point-to-flat at base); open left; breakable flange construction; no barrel drain; and a painted red finish. Depth of bury (bottom of pipe to ground surface) is generally 6 feet but may vary depending on specific site conditions. The Stortz pumper connection must be 21 in. \pm 3 in. above finish grade, and the breakable traffic flange must be between finished grade and 8 in. above finished grade.

Fire hydrant extensions shall be fully compatible with the manufacturer of the fire hydrant assembly provided and be approved by the Engineer. East Jordan Iron Works hydrants shall be provided with a model 5-BR extension kit; and, Waterous Fire Hydrants shall be provided with a F1-K562-6 extension kit.

All fire hydrants must be certified by Underwriters Laboratory (UL) or the National Sanitation Foundation (NSF) for use in a potable water system.

E. Tapping Sleeves and Valves:

Tapping sleeves and valves shall be manufactured of cast iron or stainless steel and designed for water service with a minimum working pressure of 150 psi. The sleeve shall be a full-bodied split sleeve design manufactured by one of the following manufacturers:

- (1) Clow No. F-5205;
- (2) Mueller Co. No. H-615;
- (3) Waterous Series 800;
- (4) East Jordan Iron Works MJ Tapping Sleeve with East Jordan FlowMaster RW Valve;
- (5) Tyler/Union D.I. MJ Tapping Sleeve;
- (6) Ford Meter Box Company Style FTSS;
- (7) Power Seal Model No. 3490 AS;
- (8) Smith Blair Model No. 622;
- (9) JCM 432 All Stainless Steel Tapping Sleeve; and
- (10) Price Brothers Company Tapping Sleeve for Prestressed Concrete Steel Cylinder Pipe (only to be used on concrete water mains.)

Tapping Sleeves for Pre-stressed Concrete Steel Cylinder Pipe shall be in accordance with AWWA M-9. The sleeves shall have a separate gland which permits installation of the sleeve prior to cutting of the prestress wires. The gland shall have a fusion epoxy coated (per AWWA C-213) waterway, and a broad gasket set in a retaining groove of a

pressure plate gusseted to eliminate flexing. The gland shall be equipped with load bearing set screws to protect the cylinder. Grout under saddle is needed whether saddle is epoxy coated or not. Sleeves shall be furnished with grouting seals and grout horns to facilitate filling the space between the sleeve and the pipe. Tapping sleeves shall be a Price Brothers Company Tapping Sleeve for Prestressed Concrete Steel Cylinder Pipe or approved equal.

Tapping valves shall be double-disk type of the same manufacture as the sleeve, NRS with two-inch square operating nut-opening right, and with a mechanical joint outlet.

All tapping sleeves and valves must be certified by Underwriters Laboratory (UL) or the National Sanitation Foundation (NSF) for use in a potable water system.

F. Joints:

Push-on joints shall be single gasket joint meeting the requirements of ANSI/AWWA C111/A21.11.

Mechanical joints for fire hydrants and solid sleeves shall be in accordance with ANSI/AWWA C111/A21.11 and shall be the Mega Lug Series 1100 joint restraint system manufactured by EBAA Iron Sales, Inc. or the Ford Meter Box Co. Uni-flange Retainer (UFR 1400-D-x style.).

Bolts for mechanical joints shall be high strength, low alloy steel bolts, only, meeting the requirements of ANSI/AWWA C111/A21.11. All bolts, nuts, and washers if required, shall be coated with a factory-applied flouropolymer coating meeting the following requirements:

- Use Temperature: -100°F to 500°F
- Salt Spray – ASTM B117 up to 4000 hours (nuts must not become frozen)
- Pencil Hardness – 5H to 6H – ASTM D3363-92A
- Kinetic Coefficient of Friction – 0.06 to 0.08
- Thickness – nominal 0.001" (1 mil)
- Impact – 160 in-lbs as measured by ASTM D2794-93
- Adhesion – 5B – ASTM D3359-95
- Di-electric Strength – 500V per mil
- Elongation – 35% to 50%
- Tensile Strength – 4,000 psi
- Operating Pressure – up to 100,000 psi
- Kesternich Test – Nuts not frozen up to 30+ cycles (DIN 50018)
- Corrosion Resistance as measured by:

ASTM D 1308	Muriatic Acid 31% HCL	24 hours	No Effect
	Sulfuric Acid 93% H ₂ SO ₄	24 hours	No Effect
	Caustic Soda 100% NaOH	24 hours	No Effect
	Methy Ethyl Keytone MEK	24 hours	No Effect
ASTM B117	Salt Fog	1,000 hours	No Effect

The flouropolymer coating shall strongly adhere to surface being coated and shall not flake off or be easily removed by rubbing or brushing.

Cast ductile iron river crossing pipe joints shall be a push-on type ball and socket joint utilizing a first grade rubber gasket. The joint shall be capable of 15-degree full turning deflection without separation, leakage, or restriction of the pipe waterway. Joint restraint shall be provided by a boltless means which is locked against accidental disengagement of the restraining component. Pipe shall be furnished with the necessary gaskets, lubricant, and retainer locking accessories.

Joints for restrained joint pipe shall be in accordance with ANSI/AWWA C111/A211.11. Bolts and nuts for the retainer assembly shall be stainless steel.

Restrained, push-on joint, pipe shall be American Pipe's "Fast-Grip" gasket system, U.S. Pipe's "Field-Lok 350" gasket system, or Griffin Pipe "Field Lok 350" gasket system.

The use of retainer glands and set screws shall not be acceptable.

Lubricants used in making up joints shall be supplied by the pipe manufacturer and the joints shall be coupled in accordance with the manufacturer's requirements.

G. Pipe Wrapping:

All Cast Ductile Iron Pipe, Fittings, and Valves (except river, railroad and highway crossing pipe) shall be fully wrapped with polyethylene per ANSI/AWWA C105/A21.5 and the details as contained on the plans.

H. Casing Pipe:

Steel casing pipe used for construction at railroad or State highway crossings shall comply with the following minimum requirements unless more stringent requirements are established by the railroad or State. Casing pipes at other locations shall comply with the following minimum requirements unless otherwise indicated on the Plans or in the Specifications.

Nominal Diameter of Casing Pipe (Inches)	Minimum Wall Thickness (Inches)
Under 14	0.250
14, 16, and 18	0.312
20 and 22	0.375
24, 26, 28, and 30	0.500
32 and 34	0.563
36, 38, 40, 42, and 48	0.625

Steel pipe shall be non-spiral pipe and have a minimum yield strength of 35,000 psi. All joints shall be made leakproof using full penetration, continuous welds. Welds shall be ground smooth outside and inside (except inside 22 in. diameter and less) to prevent conflict with the soil or pipe placement. Steel pipe shall meet the requirements of ASTM A 53, Type E or S, Grade B.

I. Water Main Pipe Marking:

The following information shall be clearly marked and/or cast on each length of pipe:

- (1) The pipe designation and class (e.g., D.I., Class 50).
- (2) The name or trademark of the manufacturer.
- (3) Country where cast.
- (4) The year in which the pipe was produced.
- (5) Identification of the manufacturing plant.

The following shall be distinctly cast on each fitting:

- (1) The pressure rating of the fitting.
- (2) Nominal diameters of openings.
- (3) The name or trademark of the manufacturer.
- (4) Country where cast.
- (5) The number of degrees or fraction of the circle on all bends.
- (6) Ductile iron fittings shall have the letters "DI" or "Ductile" cast on them.

J. Manufacturer's Certification:

All pipe furnished shall be accompanied by the manufacturer's certificate of test showing conformity with the Specifications. Each certificate shall identify a specific lot number, quantity of pipe, and show actual test results for the lot furnished. These certificates shall be submitted to the Inspector at the time of unloading.

All materials that will potentially be in contact with the City of Ann Arbor water supply must be certified by Underwriters Laboratory (UL) or the National Sanitation Foundation (NSF) for use in a potable water system. These materials shall include pipe coatings, pipe metals, cement linings, and joint lubricants and gaskets.

K. Inspection:

All pipe furnished shall be subject to inspection on arrival at the job site by the Engineer. The purpose of the inspection shall be to cull and reject pipe or fittings that, independent of physical tests specified under the standard specifications designated herein, fail to conform to the requirements of these Specifications.

The Contractor shall notify the Engineer sufficiently in advance so that an Inspector may be on the job during the unloading of materials. A minimum notice of 24 hours is required for such unloading and inspection. The Contractor shall also notify the Engineer when the material has arrived at the site.

All ductile iron water main pipe shall be stacked on pallets off of the existing grade, with each end plugged or bagged so as to keep the pipe interior clean until final installation.

Cast ductile iron pipe and fittings shall be subject to rejection on account of any of the

following:

- (1) Variation in any dimension exceeding the permissible variations given in the material specifications.
- (2) Any crack or defect in the cement mortar lining which, in the opinion of the Engineer, is non-repairable, including, but not limited to, loose or "hollow" lining.
- (3) Any signs of physical damage or poor manufacturing which might render the material unsuitable for its intended use.
- (4) Variation of more than 1/16 inch per lineal foot in alignment of pipe intended to be straight.
- (5) Damaged ends, where in the judgment of the Engineer such damage would prevent making a satisfactory joint.
- (6) Improper handling during delivery, unloading, or installation.

Rejected pipe shall be plainly marked by the Inspector and immediately removed from the site of the work by the Contractor, without cost to the City.

L. Water Main Bedding and Backfill Materials:

The pipe bedding and trench backfill material requirements shall be in accordance with the detailed specifications, or the details shown on the plans.

c. Construction. Water Main Installation, Bacteriologic and Hydrostatic Testing, and Acceptance Requirements shall be as described below. Installation of proposed water mains will require work in close proximity to existing utilities. This must be taken into consideration when the contractor determines the required trench safety requirements. All excavation shall conform to all relevant MIOSHA Standards; the Contractor is solely responsible for determining all excavation and trench safety requirements.

1. Dry Tap:

When a connection to an existing water main is to be made in the dry, the existing main to which a connection is to be made shall be isolated by the closing of the necessary existing valves, and the water from the existing main shall then be pumped out or removed by other means so that the connection may be made in the dry. All pipe materials and appurtenances which will come into contact with potable City water after the restoration of water service following the connections shall be disinfected with a strong chlorine solution prior to installation.

The Contractor may not operate City water main valves. For valve operation, contact City of Ann Arbor Public Services Area personnel; the City of Ann Arbor personnel will direct the operation of all valves by Contractor personnel. It is recommended that the Contractor request that the existing valves, which will need to be operated in order to perform the water main work, are checked in advance of the work to ensure that they operate properly. If the Contractor elects not to request the operation of the valves in advance of any required water main operation, then a request for extension of contract time will not be allowed.

It is possible that the valves which need to be operated to facilitate a shutdown will not close entirely, thereby allowing water to leak past the valve into the area of the shut down. The

Contractor shall provide the necessary labor, material, and equipment to enable work to be completed with a poor shut down. Under no circumstances shall the Contractor be compensated for "downtime" associated with water main valve or appurtenance failure or its inability to properly operate or close fully. An extension of contract time may be allowed, if the Contractor has requested that the water main valves have been exercised in advance of the intended water main shutdown.

Due to the size and length of pipe being shut down, and the quality of shut-down attained, large amounts of water may need to be removed from the excavation. Where possible, the water shall be run directly into nearby storm sewer inlets via pumps and hose.

The Contractor shall have all pipe, fittings and appurtenances required to complete the water main connection prior to the excavation for the connection, or the work will not be allowed to commence.

The Contractor shall complete the water main work in a manner which minimizes the disruption of water service to the greatest extent possible.

The City must notify all businesses 48 hours in advance of a water main shut-down; residences must be notified 24 hours in advance. To give the City an opportunity to provide such notification, the Contractor shall schedule the water main shut-downs at least 72 hours in advance, and preferably a full four or five days in advance, of the water main shut-down.

No water main shutdown shall take place after 12:00 p.m. (noon), unless written permission has been granted by the Engineer and that the Contractor has sufficient lighting equipment to provide a safe and efficient work area for working after dark. No water main will be shut down until the main has been exposed and cleaned, and is ready to be cut.

There shall be no gap larger than 1/4 inch left in the existing water main as a result of the tie-in. If needed, a closure piece ("thrust ring") of such size so as to meet this requirement shall be installed.

2. Wet Tap:

Prior to the installation of a tapping sleeve, the section of pipe to be tapped shall be cleaned of all foreign material and wire brushed to a smooth surface. The two halves of the sleeve shall be placed around the pipe with the gaskets installed per the manufacturer's instructions. The bolts shall be tightened evenly from the center toward the ends. The bolts shall be tightened to the manufacturer's specified torque.

When performing a wet tap in a prestressed concrete steel cylinder water main, grout is to be placed under the tapping saddle whether or not the saddle is epoxy coated.

All pipe materials and appurtenances which may come into contact with potable City water shall be disinfected with a strong chlorine solution prior to installation. This includes the pipe section to be tapped, the two halves of the sleeve, gaskets and the gate valve.

Prior to installation of the end gaskets, the sleeve shall be blocked with cement bricks such that the outlet is in proper position. The end gaskets shall be installed with an overlap as specified by the manufacturer.

The glands shall be assembled on the pipe. The bolts around the gland shall be tightened evenly, causing the gaskets to uniformly compress.

The valve shall be installed on the sleeve following the manufacturer's instructions.

Prior to tapping, the assembly shall be tested using the test plug tap in the sleeve with the valve closed, or by placing a tapped plug on the outlet of the valve with the valve open. The assembly shall be pressurized to 150 psi and hold the pressure fifteen minutes.

After the pressure test is complete, the pipe shall be tapped.

3. Oversized Water Mains:

Portions of the proposed water mains or fittings may connect with existing water mains or fittings. The possibility exists that some of the existing water mains may have been constructed using oversized, cast iron, pipe. Where tie-ins or interconnections are specified and the existing main is found to be oversized, the Contractor shall furnish and install Clow 3501B Sleeves, Tyler Dual Sleeve 5-146L, or Rockwell 441 Sleeves. These sleeves are to be present on the jobsite prior to the excavation for the water main connection, or the work will not be allowed to commence.

4. Permissible Deflection at Joints:

Wherever it is necessary to deflect ductile iron pipe from a straight line, either in the vertical or horizontal plane, to avoid obstructions, to plumb valve stems, or where long-radius curves are permitted, the amount of deflection allowed shall not exceed that required for satisfactory making of the joint, and shall be approved by the Engineer. The deflection shall not exceed the following amounts:

Size of Pipe (Inches)	Joint Angle (Degrees)	Deflection in 18 ft. (Inches)	Approx. Radius of Curve Produced by Succession of 18 ft. Lengths (Feet)
4	5	19	205
6	5	19	205
8	5	19	205
10	5	19	205
12	5	19	205
16	3	11	340
20	3	11	340
24	3	11	340

The above joint deflection angles apply to fittings as well as pipe joints.

5. Trench Opening:

The width of the trench shall be ample to permit the pipe to be laid and jointed properly, and the backfill to be placed and compacted as specified. Trenches shall be of such extra width, when required, to permit the convenient placing of timber supports, sheeting and bracing, and handling of special fittings. For each size of pipe, the minimum trench width shall provide clearance of four inches on each side of the bell of the pipe or fitting or six inches on

each side of the pipe barrel, whichever is greater. The maximum trench width shall be in keeping with good construction practice, such that existing structures are not undermined.

In excavating for water mains, the excavation shall at all times be finished to the required grade in advance of the pipe line, but unless otherwise permitted in writing by the Engineer, not more than 50 feet of trench shall be open at one time in advance of the pipe. At no time shall more than 200 feet of trench be opened and incompletely backfilled. At the end of each day, no more than 25 feet of trench may be left open, and access to all drives shall be restored. This opening shall be surrounded by fencing and barricades, or plated. The remainder of the trenching operation shall be available for safe vehicular and pedestrian traffic at all times.

The trench shall be so braced and drained that the workers may work therein safely and efficiently. It is essential that the discharge of the trench de-watering pumps be conducted to natural drainage channels, drains, or storm sewers. If trench water is pumped to natural drainage channels or drains, approved soil erosion and sedimentation controls shall be installed and maintained at the point of discharge. If trench water is pumped into storm sewers, filters shall be provided to prevent the flow of rocks, mud and other debris into the storm sewer line.

The length of street which may be occupied by the construction work at any one time shall be subject to the approval of the Engineer and will be based on the requirements of use of the street by the public.

The Contractor shall fully comply with all laws and regulations governing construction methods and the furnishing and use of all safeguards, safety devices, protective equipment, and pollution controls. Particular care shall be taken to conform to all applicable rules of the Michigan Department of Labor, Construction Safety Standards Commission, "Safety Standards". Part 9 of the above document should be particularly noted.

Where required to support the surfaces of adjacent throughfares, structures, or excavations, or to protect the construction work, adjacent work, or workmen; sheeting, bracing, and shoring shall be provided. The placing of such supports shall not release the Contractor of the responsibility for the sufficiency and integrity of the trench opening. In the removing of sheeting and bracing after the construction has been completed, special care shall be taken to prevent any caving of the sides of the excavation and injury to the completed work or to adjacent property.

Sheeting, bracing, and shoring shall not be left in place after completion of the work except as required by the Engineer. Where the Engineer requires the sheeting, bracing, or shoring to be left in place it shall be cut off below the established surface grade as required by the Engineer.

6. Laying Pipe:

Each pipe shall be inspected for defects prior to being lowered into the trench. Inside of pipe and outside of spigot shall be cleaned of any earth or foreign matter.

Proper implements, tools, and facilities satisfactory to the Engineer shall be provided and used by the Contractor for the safe and convenient prosecution of the work. All pipe, fittings,

valves, and hydrants shall be carefully lowered into the trench piece by piece by means of an excavator using chains, slings, or other suitable tools or equipment as recommended by the manufacturer, in such a manner as to prevent damage to them and their protective coatings and linings. Under no circumstances shall materials be dropped or dumped into the trench.

New water main construction shall not be connected into the existing system until it has been tested and accepted by the Engineer. Pipe shall be laid on the prepared trench bottom with the bell ends facing the direction of laying, unless otherwise directed by the Engineer.

The Contractor shall take every precaution to prevent foreign material from entering the pipe while it is being placed in the line. During laying operations, no debris, tools, clothing or other materials shall be placed in the pipe. At times when pipe laying is not in progress, the open ends of pipe shall be closed by a watertight plug. This provision shall apply during the noon hours as well as overnight. If water is in the trench, the seal shall remain in place until the trench is pumped completely dry.

Pipe shall be jointed as specified elsewhere herein. The pipe shall be secured in place with approved backfill material tamped under it except at the bells. Pipe and fittings which do not allow a sufficient and uniform space for joints shall be removed and replaced with pipe and fittings of proper dimensions to insure such uniform space. Precautions shall be taken to prevent dirt from entering the joint space.

All pipe shall be laid at the correct line and grade as indicated by the grade stakes and offset line. Each pipe, as laid, shall be checked by the Contractor to insure that this result is obtained. The staking shall be provided by the Engineer. No pipe shall be laid until a cut sheet for that pipe has been approved by the Engineer. The grade as shown on the Plans is that of the top-of-pipe for water main; and the work must conform to this profile. For water main construction, a variation from the profile grade of two inches with ductile iron pipe, and three inches with reinforced concrete pipe, will be deemed sufficient reason to cause the work to be rejected and re-laid. Water main pipe alignment shall be maintained so as not to vary more than three inches from the correct line. Any pipe found out of line shall be re-laid properly by the Contractor.

Due to conditions in the field, changes to the proposed vertical and horizontal alignment of the proposed water main may become necessary. The Contractor shall, where directed by the Engineer, excavate up to 60 feet in advance of the pipe laying operation to expose existing underground facilities thereby enabling the Engineer to make alignment decisions. The Contractor is required to realign (re-lay) the water main up to 2 feet vertically and/or horizontally as directed by the Engineer at no extra cost to the project. The excavation in advance of the pipe laying is intended to help eliminate the need for re-laying pipe.

7. Crossing Existing Structures and Facilities:

During the construction it may be necessary to cross under or over certain sewers, drains, culverts, water lines, gas lines, electric lines, fiber optic communication, telecommunication, and other types of underground structures or facilities, known or unknown. The Contractor shall make every effort to prevent damage to such underground structures and facilities. The Contractor shall not intentionally damage or break existing structures or facilities and repair them in order to expedite the water main installation process. Wherever such structures or facilities may inadvertently be disturbed or broken, they shall be restored to a

condition that is equal to, or better than, that was encountered prior to the damage. All damaged structures and/or facilities shall be made fully acceptable to the owner and the City, at the Contractor's expense. All crossings shall be made with a minimum of twelve inches of vertical clearance between or alongside existing structures or facilities.

8. Cutting Pipe:

Cutting cast iron or ductile iron pipe for inserting valves, fittings, or closure pieces shall be performed in a neat and workmanlike manner without damage to the pipe or cement lining and so as to leave a smooth end at right angles to the longitudinal axis. Where the type of pipe joint in use is such that it employs push-on assembly to effect the joint seal, the outside of the cut end shall be tapered back 1/8 inch with a coarse file or a portable grinder at an angle of about 30 degrees. The tapering must remove all sharp and/or rough edges which might injure the gasket.

The flame cutting of pipe will not be allowed. Reinforced concrete water main pipe shall not be cut.

9. Setting Water Main Fittings and Accessories:

Valves, fittings, plugs, hydrants, etc. shall be set and joined to pipe in the manner specified in the Section entitled "Making Joints."

Hydrants shall be located as shown on the Plans or as directed by the Engineer in such a manner as to provide complete accessibility and minimize the possibility of damage from vehicles or injury to pedestrians.

10. Making Joints:

Mechanical means shall be used for pulling home all rubber-gasket pipes regardless of trench condition where manual means will not result in pushing and holding the pipe home. When a trench box or liner is used, a cable shall be used to pull the joints home and hold them in position.

Where work is performed in wet trenches or trenches with running sand, the Contractor shall provide and use mechanical means for pulling the pipe home in making up the joint and for holding the pipe joints tight until completion of the line. Mechanical means shall consist of a cable placed inside or outside of the pipe with a suitable winch, jack, or come-along for pulling the pipe home and holding the pipe in position.

Where not required by these Specifications, manual means will be acceptable only if the joints can be pushed home and held.

Hydrants shall be set to stand plumb with their nozzles parallel to the street and the pumper nozzle facing the street. Hydrants shall be set with pumper nozzles between 18 and 24 inches above finished grade, or as directed in writing by the Engineer.

11. Anchorage for Water Main Fittings and Accessories:

All plugs, caps, tees, hydrants, and bends shall be provided with MDOT Grade S2 concrete

meeting the requirements of Section 701 of the 2012 MDOT Standard Specifications for Construction reaction backing (thrust block) as shown on the Plans or specified herein. Valves shall be restrained from movement at adjacent sleeves by the use of a closure piece, or thrust ring (full size pipe section cut to fill the gap inside the sleeve to within 1/4") as specified herein.

Reaction backing shall be placed between unexcavated solid ground and the fitting to be anchored. The area of bearing on the pipe and on the ground in each instance shall be that shown on the details or directed by the Engineer. The reaction backing shall, unless otherwise shown or directed, be so placed that the pipe and fitting joints will be accessible for repairs. This shall include adequate protection of any bolts from direct contact with the concrete.

Metal harnesses of tie rods or clamps may not be used instead of concrete reaction backing. Mega-Lug joint restraint systems and restrained, push-on joint, pipe shall be used where connections to existing lines require immediate pressurization, as specified herein.

In the event that the Engineer determines a change in the anchorage or design is required due to unsuitable earth conditions, changes may be ordered by the Engineer.

The use of friction clamps or set-screw type retainer glands for thrust restraint will not be allowed.

12. Abandonment or Removal of Water Main:

The Contractor shall abandon or remove water main(s) where shown on the Plans. All work shall be performed in accordance with the Detailed Specification entitled "Water Main and Appurtenances, Remove or Abandon".

13. Water Main Testing:

The water main shall be disinfected and tested by the Contractor in the presence of the Engineer in accordance with the requirements below. The Contractor shall furnish all piping, pumps, hoses, gauges, and other materials and equipment required to carry out the tests using water from the City's water mains. All chlorinated water shall be discharged directly to the sanitary sewer and will not be allowed to be discharged to the ground or any surrounding water course. Any hoses which are needed to direct water from blow-offs and/or hydrants during water main testing and flushing shall be supplied by the Contractor. The City shall furnish and install one inch corporation stops at all necessary locations, at the expense of the Contractor. The tapping of water mains, the installation of all corporation stops, and the operation of valves and hydrants is reserved for City personnel. The Contractor is required to assist in valve and hydrant operation, however. The Contractor shall give the City forty-eight hours prior written notice of intent and desire to test water mains.

A. Bacteriological Testing Sequences:

In the case of all water mains connected to existing facilities, flushing, chlorination and bacteriological testing must precede pressure testing. Where mains can be totally isolated from existing facilities with air gaps or double valves, pressure testing may precede chlorination and bacteriological testing. The normal sequence and time requirements for testing are:

Isolated (Gapped) Water Main	Connected Water Main
1. Fill Main	1. Flush and Swab*
2. Pressure Test	2. Chlorinate
3. Connect One End of Main	3. Wait; 24 hours
4. Flush and Swab*	4. Flush**
5. Chlorinate	5. Wait; 24 hours
6. Wait; 24 hours	6. Bacteriological Samples
7. Flush**	7. Wait; 24 hours
8. Wait; 24 hours	8. Bacteriological Samples
9. Bacteriological Samples	9. Wait; 48 hours
10.Wait; 24 hours	10. Pressure Test (If both sets of Bacteriological samples pass)
11.Bacteriological Samples	11. Flush
12. Wait; 48 hours	12. Wait; 24 hours
13. Make Final Connection(s) – Place in Service (If both sets of bacteriological samples pass)	13. Bacteriological Samples
	14. Wait; 24 hours
	15. Bacteriological Samples
	16. Wait; 48 hours
	17. Place in Service (If both sets of bacteriological samples pass)

*Collect flush water in operable storm water retention/detention facility.

**Discharge flush water into approved sanitary sewer.

The Contractor shall not connect any end of a newly constructed water main to an existing, in-service, water main, until the newly constructed water main passes the hydrostatic test, unless approved in writing by the Engineer.

B. Hydrostatic (Pressure Test):

Insofar as is practical, mains shall be pressure tested between valves. The maximum length of water main to be tested in any one test shall be 1500 feet. The section of main to be tested shall be slowly filled with potable water and the entrained air within the pipe removed or absorbed and pumped up to a pressure of 150 psi (or other pressure if specified) and the test period shall start immediately thereafter. The lines shall then be maintained under a test pressure of 145-155 psi for a continuous period of three hours by pumping chlorinated (25 ppm) water into the line at frequent intervals. The volume of water so added shall be measured and considered to represent the leakage from the line under test during the interval. Visible leaks shall be repaired regardless of test results.

The leakage under the conditions of the test shall not exceed the values shown in the table below. If one side of a double disc gate valve is under test pressure, that seat shall count as four joints.

Maximum Allowable Leakage per 100 Joints at 150 psi Avg. Test Pressure

Pipe Diameter (Inches)	4	6	8	10	12	16	20	24	30	36
Leakage (gallons/hr)	0.66	0.99	1.32	1.66	1.99	2.65	3.30	3.97	4.97	5.96

In the event that the leakage exceeds the maximum allowable leakage as specified above, the joints in the line shall be carefully inspected for leaks and repaired where necessary. Any pipes or fittings found to be leaking shall be removed and replaced with new pieces by the Contractor. After this work has been performed, all tests shall be repeated.

C. Flushing and Swabbing:

The Contractor shall flush the water main after making a connection to the existing City water main where a valve separates the new water main from the existing main. As a result, flushing will be accomplished using flow through the full size of the new water main. If a storm water retention/detention facility is to be constructed as part of the project, this facility is to be completed, stabilized, operable, and utilized for the collection of the flushing water. All pipe, materials, and appurtenances which will come into contact with potable City water after the restoration of water service following the connection shall be disinfected with a strong chlorine solution prior to installation.

Water main shall be cleaned using a high density poly-pig, Girard Aqua Swab (2 lbs/ft³ density) swab, or Engineer approved equal and flushed. The diameter of the blow-off pipes shall be at least 50% of the diameter of the pipe being flushed. Hydrants, with internal components removed, may serve as blow-offs for mains 12 inches and less. The Contractor shall provide details, for the review and approval of the Engineer, for the various required blow-offs. Blow-off pipes, discharge hoses, where needed, and associated costs shall be included in the cost of the permanent water main being installed and will not be paid for separately. If there are no branch connections to be swabbed, the poly-pig shall be inserted in the new water main at the time of connection described above. The poly-pig shall be located on the "downstream" or new side of the separation valve. The poly-pig shall then be forced through the new water main during the first flush and discharged through a construction blow-off of sufficient size to allow passage of the poly-pig. For water mains with branch connections, a launching tee or wye shall be installed as shown in the details, for launching multiple poly-pigs. The main line and each branch main shall be flushed and swabbed individually. Following the successful final bacteriological testing of the water main, the launching tee/wye shall be permanently capped at its branch.

During the flushing and swabbing of a water main, the discharge point for the main shall be left open, with all other discharge points closed, to direct the poly-pig completely through the main being swabbed to its point of termination. Following the initial swabbing of water main, the separation valve shall be closed, and then the discharge

point closed. If a branch water main is to be swabbed, the poly-pig is then to be placed in the launcher; the discharge point for the branch water main is to be opened; the poly-pig is to be inserted into the water main; the separation valve partially opened and the branch water main flushed and swabbed.

Following the swabbing of the water main(s), the water main(s) are to be flushed as required. If approved or directed by the Engineer, the water main(s) may be flushed overnight, provided that proper controls (i.e. hoses directed into storm structures, etc.) are installed to direct and control the flushing water.

D. Chlorination:

After the water mains to be tested have been acceptably flushed, they shall be disinfected in accordance with AWWA C651 "Disinfecting Water Mains" and these Specifications. All new mains and fittings, and any existing mains contaminated by the Contractor, shall be chlorinated to a minimum residual of fifty (50) parts per million (ppm) with commercial liquid chlorine solution (sodium hypochlorite - pool type). Other forms of chlorination and disinfection methods of water mains may be presented by the Contractor and shall receive prior approval in writing by the Engineer before being used. The minimum recommended dosage of sodium hypochlorite is as follows (based on 10% available chlorine):

Recommended Minimum Chlorine Dosage to Disinfect 100 L.F. of Pipe

<u>Pipe Diameter (inches)</u>	<u>10% Chlorine Solution (gallon)</u>
6	0.153
8	0.272
10	0.426
12	0.613
16	1.090
20	1.703
24	2.452

The chlorinated water shall remain in the mains for a minimum of 24 hours, at the end of which period the chlorinated water at all parts of the main must show free available chlorine residual of at least twenty-five (25) ppm. If less than 25 ppm residual is shown at the end of the first 24 hour period, additional chlorine shall be added until a residual of not less than 25 ppm at all parts of the system is shown after a subsequent 24 hour period. The chlorinated water shall then be removed from the mains and disposed of into an existing, approved City sanitary sewer main, or other location approved in writing by the Engineer. All chlorinated water shall be discharged directly to the sanitary sewer and will not be allowed to be discharged to the ground or any surrounding water course. The mains shall then be left full of water ready for bacteriological testing.

E. Bacteriological Testing:

The City will obtain bacteriological samples of the water in the mains for analysis from testing blow-offs, corporations, or other sampling points as determined acceptable by the

City. Samples will be taken after the mains have been satisfactorily chlorinated in accordance with these Specifications, the chlorinated water flushed out and removed, and the mains filled with potable water. If the newly constructed water main is connected at one end to an in-service section of the City water main, and the chlorination precedes pressure testing, the City will also take samples after satisfactory pressure testing. In each case, two sets of samples shall be taken; a period of 24 hours must elapse between flushing of the main and drawing of the first samples, with the second samples being drawn 24 hours after the first samples were drawn. For each sample, a minimum of 48 hours is required to obtain test results. All samples must pass the bacteriological test.

The Contractor shall plan for these testing sequences and durations in his construction schedule. Contract time will continue during all water main testing phases, regardless of duration.

d. Construction. The Contractor shall be responsible for coordination with the City of Ann Arbor Field Operations Unit for the installation of 1-inch corporations in the gate wells to be used for water main testing and/or filling of new main.

The Contractor must have all materials, fittings, pumps and other miscellaneous equipment, and personnel on-site before the City of Ann Arbor Public Services personnel will prepare and shutdown and existing main.

Pipe bedding and trench backfill material requirements shall be in accordance with the detailed specifications, or the details shown on the plans. Construct water main pipe bedding using granular material Class II, placed in layers no greater than 10 inches thick. Compact each layer to at least 95 percent of maximum unit weight for the entire length of the pipe. Where rock or hardpan is encountered, excavate the trench to at least 6 inches below the proposed bottom of the pipe; backfill with granular material Class II, and compact.

Where unstable soil conditions, or obstructions other than rock, require excavation of the trench below the elevation detailed on the plans; undercut, backfill, and compact the trench as directed by the Engineer. Use 6A, 17A, or 34R aggregate as backfill material for undercutting due to unstable soil conditions. This work will be paid for as trench undercut and backfill according to subsection 402.04.E of the Michigan Department of Transportation 2012 Standard Specifications for Construction.

The Contractor shall backfill water mains within the limits of the roadbed with granular material Class II. Place backfill in layers no greater than 10 inches thick and compact each layer to at least 95 percent of the maximum unit weight. Backfill water main outside the limits of the roadbed with Engineer approved granular or suitable material, compacted to 90% of the maximum unit weight, in lifts of 12 inches or less, unless otherwise noted on the plans.

The Contractor shall excavate and expose all utility crossings prior to laying any water main pipe. This will allow the Engineer to adjust the grade of the water main, if possible, to avoid the existing utilities. The costs of this work, and all related costs, shall be included in the respective pay items associated with this Detailed Specification.

Should the water main, or other pay items associated with this Detailed Specification, conflict with abandoned sewers or water mains, the conflicting section of the abandoned sewer or water main shall be removed and the remaining sections shall be (re)abandoned in accordance the Detailed

Specification for "Water Main and Appurtenances, Abandon" and the Detailed Specification for "Sewer, Any Size or Depth, Abandon," except that flow filling the sewer will not be required. All the work shall be included in the cost of the water main, or other pay items in this Detailed Specification.

All water main construction shall be completed in accordance with the Detailed Specification entitled "Maintaining Traffic" and as detailed on the plans. The Contractor shall schedule and coordinate all water main shutdowns with the Engineer. The Contractor shall submit for the Engineer's review and approval the sequence of all water main "shut downs" and tie-ins such that disruption in service to existing properties is minimized to the greatest extent possible. Should the Engineer not accept the Contractor's proposed construction sequence, it shall not be a basis of claim for extension of contract time or additional compensation.

All water main and appurtenances shall be pressure tested, cleaned, disinfected and bacteriological tested in accordance with the specifications outlined within this Detailed Specification.

Upon acceptance of each section of new main the Contractor shall begin coordination with the City of Ann Arbor Public Services Area for the installation of water services, curb stops and boxes in accordance with the Detailed Specification for "Water Service Tap and Lead, Excavate and Backfill."

g. Measurement and Payment. The work for all items shall include, but not be limited to; pavement saw-cutting; excavation and disposal of excavated material; connections to new and existing water mains; the furnishing and installation of solid sleeves and push-on-joint plugs where needed; the furnishing, installation, and removal of sheeting and/or shoring where needed; polyethylene wrap; the furnishing, placement and compaction of approved bedding and backfill materials; thrust blocks; additional labor and equipment costs associated with any required nighttime water main work; cleaning, disinfecting, flushing, bacteriological and hydrostatic testing; and any other required items to complete the work as shown on the plans, as detailed in this Detailed Specification, and as directed by the Engineer.

The completed work, as described, will be paid for at the contract unit prices respectively for the following pay items:

<u>Pay Item</u>	<u>Pay Unit</u>
Class 50 DIP w/Polyethylene Wrap, ___ inch & SD-TD-I	Foot
Fire Hydrant Assembly	Each
___ Inch Gate Valve in Well	Each
DIP ___" ___" Degree Bend	Each
DIP ___"x___" Reducer	Each
DIP ___"x___"x___" Tee.....	Each
Water Main, Tie-in.....	Each

All work shall be paid in full at the contract unit prices which shall include all the labor, materials and equipment required including all required costs associated with night time work, supplemental lighting, and all other required elements of the work.

Fittings other than those specifically listed as separate contract items, blow-off assemblies, hoses, and restrained joint pipe and gaskets, special gaskets, and the like, shall not be paid for separately, but shall be considered included in the payment for Class 50 DIP w/Polyethylene Wrap, ___ inch & SD-TD-I.

Tees, Crosses, Bends, and Reducers and other fittings specifically listed as separate contract items (pay items), shall be paid for at the contract unit price for each unit installed.

Valve Box Extensions will only be paid for if they are required by the plans and they are not required due to the Contractor's operations.

The work of installing a gate valve-in-well shall include installation and backfill of the specified valve, furnishing and installing pre-cast concrete gate wells including the concrete base, straight pre-cast concrete sections, transition sections, and the adjustment of the structure cover. No separate payment will be made for adjusting the structure covers on new gate wells. The gate well cover shall be paid as "Dr Structure Cover, Type B." Upon completion of the work, the Contractor shall clean the Gate Well to the approval of the Engineer.

The fire hydrant assembly work shall include the hydrant, the 6 inch gate valve-in-box, 3 feet of 6 inch pipe, the thrust block, and any required extensions to install the fire hydrant to the finish grade as shown on the plans.

CITY OF ANN ARBOR
DETAILED SPECIFICATION
FOR
TEMPORARY WATER MAIN LINE STOP

AA:DAD

1 of 5

04/08/15

a. Description. The Contractor shall furnish all materials, labor and equipment to properly install and set water main line stops into the existing Ductile Iron Main(s) at the locations as shown on the plans and as directed by the Engineer. All work shall be performed in accordance with the requirements as detailed herein.

The existing mains, upstream and downstream of the proposed line stop(s) cannot be shut down or taken out of service. To ensure that the entire operation shall be accomplished without interruption of service or flow, the installation shall be accomplished by Contractor personnel skilled and experienced in the procedures specific to line stops of the required size(s).

b. Materials. Bedding and trench backfill materials and compaction requirements shall be in accordance with the detailed specifications, or the details shown on the plans. Granular Material Class II shall meet the requirements of section 902 of the Michigan Department of Transportation 2012 Standard Specifications for Construction. The Engineer shall approve any native materials to be placed as trench backfill.

The Contractor shall submit to the Engineer two (2) sets of drawings, furnished by manufacturers, fully and distinctly illustrated and describing the Line Stop fittings proposed to be furnished. Work shall not commence until such time as the drawings have been reviewed and accepted by the Engineer.

Line Stop Fittings shall be full encirclement, pressure retention type split tee. It shall consist of two steel weldments; an upper line stop flange saddle plate and a lower saddle plate. These two saddle plates shall be contiguous.

1. **Line Stop Flange:** The outlet of each fitting shall be machined from a 150 lb. forged steel flange (ASTM A181 or A105) or from pressure vessel quality steel plate (ASTM A285, Grade C); flat faced and drilled per ANSI B16.5). Suitable independently operated locking devices shall be provided in the periphery of the flange to secure the completion plug.
2. **Line stop Nozzle:** The nozzle, which lies between the saddle and the flange shall be fabricated from steel pipe (ASTM A234). After welding and stress relief, the nozzle shall be accurately bored as follows to accommodate the Line stop plugging head:
3. Machine an internal circular shoulder to seal against the circumferential gasket carried on the plugging head.
4. **Completion Plug:** The completion plug shall be machined from a stress relieved carbon steel weldment. It shall contain two (2) circumferential grooves: one to receive the locking devices from the Line stop flange, and the second to contain a compressible "O" ring to seal pressure tight against the bore of the flange.
5. **Blind Flange:** Each Line stop fitting shall be closed with a blind flange. Facing and drilling

of the blind flange shall be compatible with that of the Line stop flange. Minimum blind flange thickness shall be that of AWWA Spec. 207, Class D.

6. Saddle Alignment Marking: Each saddle-half shall be matched and marked with serial numbers, to insure proper alignment in the field.

7. Fasteners: All bolts, studs, and nuts used on Line stop, drain/equalization fittings, blind flange, and other elements that shall remain upon completion of the work shall be stainless steel and meet the requirements of ASTM F 593.

8. General: Manufacturer will exercise extreme care to insure that weldments are of adequate strength, properly shaped, securely reinforced, and free from distortion that could stress the ductile iron main during installation, pressure tapping, or Line stopping operations. All steel shall meet the requirements of ASTM A36, as a minimum. All weldments shall be braced and stress relieved.

9. Gaskets: Shall be molded from elastomer compounds that resist compression setting and are compatible with water in the 32 to 140 deg. F temperature range.

10. Upper Line stop Flange Saddle: Shall consist of a saddle plate, a Line stop flange, and a Line Stop nozzle. The interior of the saddle plate, adjacent to and concentric with the O.D. of the nozzle, shall be grooved to retain a gasket which shall seal the saddle plate to the exterior of the ductile iron main. This gasket shall constitute the only seal between the main and the fitting. The flange saddle shall also meet the following requirements:

A. Saddle plate shall be of a minimum of 0.375" in thickness. It shall be shaped to be concentric to the outside of the ductile iron main. The smallest I.D. of the saddle and its interior rings shall exceed the O.D. of the main by a minimum of 0.250" to allow for ovality of the main.

B. Line stop nozzle of 0.375" min. wall thickness shall be securely welded to the saddle plate.

C. The Line Stop flange shall be securely welded to the nozzle. After welding, the assembly shall be braced, stress relieved, and bored to receive the completion plug and the circumferential gasket of the Line Stop machine plugging head.

D. Bolt, nut of stud, nut, and washer assemblies shall be furnished to draw the upper and lower saddles together for sealing. Bolting brackets shall be gusseted.

11. Lower Saddle Plate: Saddle plate shall be of a minimum 0.375" thickness and shall be shaped to be concentric to the outside brackets shall match upper half.

c. Construction. Installation of proposed line stops mains will require work in close proximity to existing utilities. This must be taken into consideration when the contractor determines the required trench safety requirements. All excavation shall conform to MIOSHA Standards; the Contractor is solely responsible for determining all excavation and trench safety requirements.

If necessary, The City will reduce the pressure to 100 psig or less for the duration of the installations. The entire operation of installing the line stop shall be accomplished without reduction of water pressure in the main(s) below 100 psig. It shall be the responsibility of the Contractor to verify pressure prior to commencing the installation.

1. Equipment. The equipment shall consist of a cylindrical plugging head that contains a flat, expandable elastomer sealing element. The plugging head shall be advanced into and retracted from the main by means of a linear actuator. When retracted, the plugging head and carrier are housed in an adapter, bolted pressure tight between the tapping valve and the actuator.

A. Sealing Element: The element shall be monolithically molded from a suitable polyurethane compound. The element shall be flat in a plane perpendicular to the flow in the main. Minimum thickness of the element shall be 4". The bottom of the element shall be semi-circular to conform to the bore of the main.

B. Drilling equipment: Shall be in good working condition, equipped with power drive to insure smooth cutting, and to minimize shock and vibration. Cutting equipment shall be carbide tipped and capable of being replaced without removal from the jobsite.

C. Plugging Head: The diameter of the cylindrical plugging head shall be slightly smaller than the bore of the Line Stop nozzle. The plugging head shall have a suitable circumferential gasket to seal against the shoulder in the Line stop nozzle. This gasket shall also seal against the sealing element to prevent bypass flow around the Line stop.

D. Deposits in Bore of Main: The semi-cylindrical bottom of the plugging head shall be designed to break and dislodge tuberculation and other deposits in the bore of the main which might interfere with a satisfactory Line stop.

2. Preliminary Field Inspection of Water Main:

A. Dimensional, specification, and other data regarding the existing mains have been taken from existing records. This information may be inaccurate, out of date, and/or inadequate. The data have not been verified by field inspections. Further, the water main consists of ductile iron pipe which may contain dimensional and structural flaws. In addition, the Contractor shall anticipate that exterior main conditions, bells, service connections, or presence of adjoining utilities may require relocation of proposed line stop. Prior to proceeding with the installation of any line stop, it is necessary to know the exact main outside diameter of the water main, if it has any ovality, and the internal diameter of the pipe before line stop fittings and plugging head sealing elements can be manufactured and/or ordered.

B. Prior to ordering material, Contractor shall excavate at each proposed location and carefully measure the outside diameter of the water main with calipers along at least four (4) locations to determine ovality and the critical outside diameter of the water main. The Contractor shall determine main wall thickness, uniformity, and structural integrity by means of ultrasonic testing. Data shall be taken to determine extent of internal deposits, tuberculation, etc.

C. If the Engineer determines that Contractor's data are not adequate, the Engineer may direct Contractor to make one or more pressure taps on main to obtain test pipe coupons for the Engineer's evaluation. The minimum size of the test coupon shall be 5" diameter, drilled through a nominal 6" valve. Pressure tapping saddles and other materials used for inspection taps shall conform to the requirements of this Special Provision. The Contractor shall anticipate that heavy interior corrosion and/or tuberculation exists within the water main.

D. If, in Engineer's opinion, the proposed location is unsatisfactory based on measurements of the existing pipe at the locations of the proposed line stops, the Engineer will direct excavation at another site. Excavating, de-watering, inspections, backfill, and restoration will be paid for separately in accordance with the applicable contract unit prices or Section 109.05.C and 109.05.D whichever the Engineer deems most appropriate.

Because of possible internal corrosion and deposits in existing water mains, a "bottle-tight" shut down may not occur. A satisfactory shutdown which allows the work to be accomplished (i.e. valve replacement, water main tie-in, etc.) using drainage pumps to de-water excavations, with workmen wearing boots and raingear, if necessary, must be obtained. The Contractor will not be allowed to proceed with further work until an acceptable shutdown is achieved. The Contractor shall be aware that this may require the halting of work and re-scheduling of all work operations.

Contractor shall power wire brush and grind the exterior of the water main to remove any debris, corrosion deposits, or other surface irregularities that might interfere with proper seating and sealing of each line stop fitting against each main. Any structural defects in the water main, service connections, appurtenances, adjacent utilities, etc., that could interfere with the line stop installation shall be immediately reported to Engineer.

All line stop fittings and appurtenances shall be cleaned and disinfected in accordance with the current City of Ann Arbor Public Services Area Standard Specifications prior to bolting any of the line stop fittings in place or commencing any pipe cutting.

Contractor shall fit upper and lower saddle plate assemblies to main, thoroughly checking for proper fit to main. Under no circumstances shall Contractor attempt to force, reshape, or bend saddle plates by excessive tightening of saddle studs while the line stop fitting is assembled around the main. Any required retrofitting shall be accomplished with the fitting removed from the main. Any damage to fitting, accessories, or main shall be repaired at Contractor's expense to the satisfaction of Engineer.

Upper and Lower saddle halves shall be drawn together by bolt assemblies and the Saddle plates shall be bolted together in the horizontal position.

All line stop work shall be performed in accordance with the equipment manufacturers approved work procedures and installation guidelines.

Final closure of the water main shall be accomplished by insertion of a manufacturer-approved completion plug. The Contractor shall test the completion plug sealing through the use of a bleed off assembly in the machine housing.

The Contractor shall remove the temporary valve and the installation of a blind flange shall be completed.

The Contractor shall backfill water mains within the limits of the roadbed with granular material Class II. Place backfill in layers no greater than 10 inches thick and compact each layer to at least 95 % of the maximum unit weight. Backfill water main outside the limits of the roadbed with Engineer approved granular or suitable material, compacted to 90% of the maximum unit weight, in lifts of 12 inches or less, unless otherwise noted on the plans.

The Contractor shall place polyethylene encasement meeting the requirements of the City of Ann Arbor Standard Specifications for Construction around the upper and lower saddle halves, the blind flange, and to a point at least 1 foot on either side of the saddle halves. All polyethylene encasement shall be securely taped to the water main such that water entry is minimized to the greatest extent possible.

d. Measurement and Payment. The work shall include, but not be limited to; pavement saw-cutting; excavation and disposal of excavated material; the furnishing, installation, and removal of sheeting and/or shoring where needed; the furnishing, placement and compaction of approved bedding and backfill materials; furnishing and placing suitable, clean, gravel to create a stable working surface at the bottom of the excavation; de-watering; pipe cleaning, measuring, and performing all advance work necessary to prepare for the performance of the line stop; nighttime lighting as required; the removal of all materials and equipment associated with the work when no longer needed; and, any other items needed to complete the work as detailed on the plans and as specified herein.

The completed work, as described, will be paid for at the contract unit price for the following pay item:

<u>Contract Item (Pay Item)</u>	<u>Pay Unit</u>
Line Stop, __ inch, Temp.....	Each

All work shall be paid in full at the contract unit prices which shall include all the labor, materials, and equipment required to perform the work as detailed herein. This shall also include all required costs associated with night time work, supplemental lighting, and all other required elements of the work.

CITY OF ANN ARBOR
DETAILED SPECIFICATION
FOR
EXCAVATE AND BACKFILL FOR WATER SERVICE TAP AND LEAD

AA:DAD

1 of 1

04/08/15

a. Description. This work shall consist of exposing new or existing water mains and excavating and backfilling a trench from the water main to the property line, at the locations shown on the drawings, or as directed by the Engineer, for the purpose of installing new water services or transferring existing water services to new water mains or replacing existing water services on existing water mains.

b. Materials. The backfill material shall meet the requirements for Granular Material, Class II specified in section 902 of the Michigan Department of Transportation (MDOT) 2012 Standard Specifications for Construction.

c. Construction. The trench is to be excavated to the applicable MIOSHA standards for the purposes of transferring water services, installing water service taps, leads, and curb stops and boxes. The City will furnish all labor and materials for taps, leads, and curb stops and boxes. The Contractor will not be entitled to extra compensation due to delays caused by City of Ann Arbor personnel in performing work on the project. The Contractor shall be responsible for all coordination with the City of Ann Arbor – Field Operations personnel for the scheduling and execution of the work.

Granular Material Class II bedding (3 inch) and backfill material shall be placed in lifts not to exceed 12 inches and compacted to a minimum of 95% of its maximum dry density as measured by the AASHTO T-180 test.

d. Measurement and Payment. The completed work, as described, shall be paid for at the contract unit price for the following pay item:

<u>Pay Item</u>	<u>Pay Unit</u>
Excavate & Backfill for Water Service Tap and Lead	Foot

Excavate & Backfill for Water Service Tap and Lead shall be measured by length in feet from the new or existing water main to the curb stop and box or the location where the new and existing water services are to be re-connected. The Contractor shall be aware that the plan quantities are estimates only. The actual amount of excavation and backfill may be significantly more or less based on actual field conditions. Price adjustments based upon subsection 103.02.B of the MDOT 2012 Standard Specifications for Construction shall not apply to this item of work.

Payment for **Excavate & Backfill for Water Service Tap and Lead** shall include, but not be limited to; all labor, material, and equipment costs necessary to schedule and coordinate with City of Ann Arbor personnel for the work of transferring and/or installing new water services; expose and backfill the new water main; excavate, backfill, and compact the water service trenches; and, properly dispose of all excess excavated materials.

CITY OF ANN ARBOR
DETAILED SPECIFICATION
FOR
WATER MAIN AND APPURTENANCES, REMOVE OR ABANDON

AA:DAD

1 of 2

04/08/15

a. Description. This work shall include abandoning or removing existing water mains, valves, valve wells, valve boxes, and fire hydrant assemblies of various sizes as required by the Plans. All work shall be performed in accordance with the project plans, as detailed in this Special Provision, and as directed by the Engineer.

b. Materials. All materials shall meet the requirements specified in the following sections of the Michigan Department of Transportation (MDOT) 2012 Standard Specifications for Construction as follows:

Mortar Type II	Section 702
Granular Material, Class II	Section 902
Masonry Units	Section 913

Push-on joint plugs and thrust blocks shall conform to the requirements as detailed in the Special Provision entitled "Water Main and Appurtenances."

c. Construction. The Contractor shall abandon water mains where shown on the Plans. This includes, but is not limited to, cutting the main at each end, plugging the live main at the end(s) with push-on joint plug(s) and thrust block(s), plugging the abandoned main at its end(s) with brick and mortar, concrete, or mechanical joint plug, breaking down any manholes (remove manhole ring and cover and the top 4' of manhole structure, breaking out the manhole base, and backfilling as specified herein) in the abandoned line, removing and salvaging any valves and fittings, plugging the pipe in manholes with brick and mortar, concrete, or mechanical joint plugs.

In locations as shown on the Plans or where abandoned water main, valves or valve wells are within 30 inches of the proposed subgrade, the pipe, valves or valve wells shall be removed completely. The resulting hole or trench shall be backfilled with Granular Material Class II in maximum lifts of 10 inches, and be compacted to 95% of its maximum dry density, if located within the public rights-of-way, or within the influence of paved surfaces or structures. Otherwise, backfill shall be Engineer approved native material, compacted to 90% of its maximum dry density, in lifts of 12 inches or less, unless otherwise noted on the plans.

Abandoned (salvaged) or removed valves and fire hydrant assemblies shall be neatly stacked on-site in a single location so that City of Ann Arbor forces can retrieve them at a later date. The Contractor shall assist City forces by loading them into City trucks.

d. Measurement and Payment.- The completed work, as described, shall be paid at the contract unit prices respectively for the following pay items:

<u>Pay Item</u>	<u>Pay Unit</u>
Water Main Pipe, ___inch, Abandonment	Foot
___" Gate Valve in Box, Abandon	Each
Water Main, Remove	Foot
Fire Hydrant Assembly, Remove	Each

Water Main Pipe, ___inch, Abandonment and Water Main, Remove shall be measured and paid for by length in lineal feet and shall include all labor, materials, and equipment necessary to abandon or remove the pipe including, but not limited to, excavation, cutting of pipe, push-on joint plugs and thrust blocks, brick and mortar bulkheads, the furnishing, placement, and compaction of approved granular backfill material, as required, and the removal and proper disposal off-site of excess materials.

Fire Hydrant Assembly, Remove shall be paid for at the contract unit price for each unit removed.

Fire Hydrant Assembly, Remove includes payment for storing, stockpiling, and loading hydrants into City vehicles, and for abandoning or removing the companion valve, as directed by the Engineer.

APPENDIX

**GEOTECHNICAL INVESTIGATION
MISCELLANEOUS GEOTECHNICAL SERVICES –
NORTH AREA BORINGS
ANN ARBOR, MICHIGAN
CTI PROJECT NO. 3122040060-1**

NOVEMBER 13, 2012

Prepared for:

**City of Ann Arbor
Public Services Area - Project Management
301 E. Huron Street
P.O. Box 8647
Ann Arbor, Michigan 48104-8647**

Prepared by:

**CTI and Associates, Inc.
51331 W. Pontiac Trail
Wixom, Michigan 48393
248-486-5100**



November 13, 2012

Mr. Nicholas Hutchinson, P.E., Project Engineer
City of Ann Arbor
Public Services Area - Project Management
301 E. Huron Street
P.O. Box 8647
Ann Arbor, Michigan 48104-8647

**RE: Geotechnical Investigation
Miscellaneous Geotechnical Services –
North Area Borings
Ann Arbor, Michigan
CTI Project No. 3122040060-1**

Dear Mr. Hill:

As requested, CTI and Associates, Inc. (CTI) has completed a geotechnical investigation as part of the Miscellaneous Geotechnical Services contract for the "North Area" soil borings. This phase of work included performing a total of 114 soil borings on seventeen different streets within Ann Arbor city limits. The majority of the soil borings were performed for the design phase of the City of Ann Arbor's Street Resurfacing program. The remaining borings were performed to support utility design projects.

The enclosed report presents the results of our findings and an engineering interpretation of these with respect to the soil related phases of the project including pavement and construction recommendations. Based on the soils encountered, we anticipate subgrade improvement will be necessary on Depot Street and several isolated areas on the remaining streets. The specific areas requiring subgrade improvement should be anticipated during the design phase, based on the information contained in this report, and further defined during the construction phase.

The pavement cores and soil samples will be retained in our laboratory for a period of thirty (30) days, unless instructed otherwise, and may be examined upon request.

We appreciate the opportunity to be of service to you on this project. If you have any questions regarding this report or if we can be of further assistance, such as providing field monitoring and quality control inspection services during construction, please contact our office.

Sincerely,

CTI and Associates, Inc.

Theresa M. Marsik, P.E., LEED AP
Senior Project Engineer

Kevin Foye, Ph.D., P.E.
Project Engineer

TABLE OF CONTENTS

1.0	INTRODUCTION	1
1.1.	General.....	1
1.2.	Purpose and Scope	1
2.0	SITE CONDITIONS AND PROJECT DESCRIPTION	3
2.1.	Project Description.....	3
2.2.	Site Conditions	4
3.0	INVESTIGATION PROCEDURES	5
3.1.	Field Investigation.....	5
3.2.	Laboratory Testing.....	6
4.0	GENERAL SUBSURFACE CONDITIONS	8
4.1.	Pavement and Soil Conditions	8
4.1.1.	W. Ann Street	8
4.1.2.	Barton Drive	8
4.1.3.	Depot Street.....	9
4.1.4.	S. Division Street	9
4.1.5.	Geddes Avenue	9
4.1.6.	Green Road	10
4.1.7.	Hiscock Street.....	10
4.1.8.	Miller Avenue	11
4.1.9.	Moore Street	11
4.1.10.	Newport Road	12
4.1.11.	Penberton Court/Penberton Drive	12
4.1.12.	Rock Creek Drive/Court	13
4.1.13.	S. State Street.....	13
4.1.14.	N. Thayer Street.....	14
4.1.15.	Yellowstone Drive	14
4.2.	Groundwater Conditions	16
5.0	ANALYSIS AND DESIGN RECOMMENDATIONS	17
5.1.	Site Preparation and Engineered Fill Placement.....	17
5.2.	Pavement Design Considerations.....	20
6.0	GENERAL CONSTRUCTION PROCEDURES / RECOMMENDATIONS	23
6.1.	General.....	23
6.2.	Groundwater Control	23

APPENDIX

Boring Logs, Summary of Laboratory Test Results, General Notes for Soil Classification



**GEOTECHNICAL INVESTIGATION
MISCELLANEOUS GEOTECHNICAL SERVICES –
NORTH AREA BORINGS
ANN ARBOR, MICHIGAN
CTI PROJECT NO. 3122040060-1**

NOVEMBER 13, 2012

1.0 INTRODUCTION

1.1. General

This report presents the results of the geotechnical investigation performed by CTI and Associates, Inc. (CTI) for the “North Area” soil borings as part of the Miscellaneous Geotechnical Services contract. The majority of the soil borings were performed for the design phase of the City of Ann Arbor’s Street Resurfacing program. The remaining borings were performed to support utility design projects.

Recommendations for the construction observation and preparation of the encountered subgrade soils to make them suitable for pavement construction are included in the report sections that follow. Of particular concern is the poor-draining nature of the encountered soils and fill materials in the subgrade. These materials may not be suitable for direct pavement support and will require further evaluation and improvement as detailed below.

Our evaluation was performed in general accordance with the scope of services outlined in the CTI Proposal No. 112PR02040-100 dated July 12, 2012 and the Professional Services Agreement between the City of Ann Arbor and CTI dated August 1, 2012. Purchase Order No. 2013-00000194 was issued by City of Ann Arbor on September 17, 2012.

1.2. Purpose and Scope

The purpose of this study was to determine the general subsurface conditions at the site by performing pavement cores and drilling test borings, and to evaluate these conditions with respect to pavement support requirements for the proposed project. Specifically, the report presents our evaluations and recommendations regarding the following items:

- A. General subsurface (soil and groundwater) conditions at the site.
- B. Design recommendations: These include recommendations for support of pavement, including pavement design parameters as they relate to the encountered soils.
- C. Construction recommendations: These include site preparation and earthwork operations, groundwater conditions and controls, potential construction problems and recommendations dealing with quality control during construction.

The evaluations and recommendations discussed in this report are based on the soil conditions encountered in the test borings performed at the specific locations on the date indicated on the boring logs. The soil conditions may vary at locations other than those encountered at the soil boring locations. These variations may not become evident until the time of construction.

If variations in the reported soil conditions are encountered, CTI should be contacted immediately. In such a case, it may be necessary for CTI to reevaluate the recommendations of this report. Such a reevaluation may be possible from on-site observations or may require additional investigations. If any such variations are revealed, they may result in increased construction costs. A contingency should be provided in the project budget to accommodate such variations.

CTI's authorized scope of services included a geotechnical study of the subject site and did not include an environmental assessment for determining the presence or absence of hazardous or toxic materials in the soil or groundwater at, below or around the site. The presence or absence of contaminated material is not implied, inferred or suggested by this report or the results of this study. Any statement contained within this report or presented on the soil boring logs regarding odors, colors or unusual items are strictly for informational purposes only. If any recognized environmental concerns are identified for this site, the evaluations and/or recommendations presented in this report may require amendment.

2.0 SITE CONDITIONS AND PROJECT DESCRIPTION

2.1. Project Description

CTI was awarded the “North Area” borings on September 14, 2012. Additional borings were added to the scope and boring depths were modified through October 1, 2012. This phase of work included performing a total of 114 soil borings on seventeen different streets within Ann Arbor city limits. The proposed boring locations were marked in the field by the City of Ann Arbor personnel prior to our field activities. CTI was notified on September 25, 2012 that all of the boring locations were marked. Once we were notified that the boring locations had been marked, CTI requested the Miss Dig service to locate the existing underground utility locations at each boring location. Several borings were off-set from the marked location due to conflicts with underground utilities, overhead obstructions (trees and overhead electric lines) and/or to maintain traffic flow. Table 1 presents the specific breakdown of the number of borings per street, the boring depths, and the limits of exploration.

Table 1. Summary of Geotechnical Investigation Scope

Street Name	Limits	Number of Borings	Boring Depth (ft)
W. Ann Street	First Avenue to N. Main Street	2	5
Barton Drive	Pontiac Trail to Plymouth Road	8	5
Depot Street	N. Main Street to Carey Street	4	5
S. Division Street	Huron Street to Packard Street	9	5
Geddes Avenue	Observatory Street to Highland Drive	10	5
Green Road	Nixon Road to Burbank Road	18	5
Hiscock Street	Brooks Street to Spring Street	6	5
Miller Avenue	City Limits to Maple Road	9	5
Moore Street	Pontiac Trail to Broadway	2	5
Newport Road	City Limits to Warrington	9	5
Penberton Court	3925 to 3935 Penberton Court	1	5
Penberton Drive	Fox Hunt to Waldenwood	7	5
Pontiac Trail	City Limits to Skydale Drive	7	25
Rock Creek Drive/Ct.	Northern End to Huntington Drive	6	7.5
S. State Street	Washington Street to S. University Avenue	6	5
N. Thayer Street	Huron Street to Kingsley Street	5	5
Yellowstone Drive	Bluett to Bluett	5	5

The recommendations presented in this report are based on the provided and/or assumed project information and the results of our geotechnical exploration. If any of the above noted project information is considered incorrect or is changed, CTI should be informed in writing so that a review can be performed and any necessary revisions to our recommendations can be made.

2.2. Site Conditions

At the time of our field investigation, the existing roadway surfaces consisted of asphalt pavement. No information was provided regarding the age of the existing asphalt pavement.

3.0 INVESTIGATION PROCEDURES

3.1. Field Investigation

Our field investigation consisted of drilling 114 soil borings on seventeen different streets within Ann Arbor city limits. The approximate as-drilled locations of the borings are listed on the boring logs, included with this report. As requested, the majority of the borings were extended to a depth of approximately 5 feet below the top of pavement. Those borings performed on Rock Creek Drive/Court were extended to a depth of 7½ feet, and those borings performed on Pontiac Trail were extended to a depth of 25 feet below the existing grade.

Several boring locations on Pontiac Trail were in conflict with overhead and underground utilities. Miss Dig was contacted and all utilities were supposed to have been marked by September 28, 2012. During the drilling operations on October 12, 2012, a utility marking company arrived at the site to mark fiber optic lines which had not previously been marked, and they informed CTI and Stearns Drilling personnel that a high voltage underground electric line was present at the site which had also not been marked. CTI made several telephone calls to the various utilities – both through the Miss Dig system and directly – but the marking was not completed. Therefore, drilling activities have not been completed for Pontiac Trail. The information from the seven borings for Pontiac Trail will be transmitted separately once drilling on Pontiac Trail has been completed.

The borings were located in the field by City of Ann Arbor personnel prior to the drilling activities. The drilling operations were performed by Stearns Drilling, under direction of CTI personnel between October 3 and October 12, 2012. Prior to drilling the soil borings, the pavement structure was explored with a core drill equipped with a four-inch nominal diameter core barrel. After extraction of the cores at each location, the core samples were measured and labeled. The soil borings were drilled with a CME-1050 rotary drill rig using continuous flight hollow stem augers. Soil samples were obtained at select intervals by the Standard Penetration Test Method (ASTM D-1586), whereby a 2-inch outside diameter split-barrel sampler is driven into the soil with a 140-pound weight falling freely through a distance of 30 inches. The sampler is generally driven three successive 6-inch increments, with the number

of blows for each increment being recorded. The number of blows required to advance the sampler from 6 to 18 inches is termed the Standard Penetration Resistance, N. An additional grab sample was obtained of the aggregate base material directly below the pavement for visual classification purposes.

The soil samples obtained with the split-barrel sampler were sealed in glass jar containers and transported to our laboratory along with the pavement core samples for further classification and testing. After completion of the drilling operations, the boreholes were backfilled with excavated soil (i.e., auger cuttings) and patched with a cold bituminous patching mix.

Soil and groundwater conditions observed in the test borings have been evaluated and are presented on the boring logs included in the Appendix. To aid in understanding the data presented on the boring logs, "General Notes for Soil Classification," describing nomenclature used in soil descriptions, are also included in the Appendix. It should be noted that the soil descriptions reported on the test boring logs are based upon field logs prepared by experienced drillers with modifications made based on the results of laboratory testing and engineering review.

3.2. Laboratory Testing

The laboratory testing program was directed towards determining the general soil classification and physical properties of the soil pertinent for pavement design and site preparation. All laboratory testing was performed in general accordance with applicable ASTM test method standards. The laboratory testing consisted of visual soil classification of every sample, and natural moisture content and loss-on-ignition (organic) testing of selected samples. The unconfined compressive strength of selected cohesive samples was also estimated based on the resistance to a calibrated spring-loaded hand penetrometer. In addition, corrosivity testing, including pH determination, Laboratory Resistivity testing and Oxidation-Reduction Potential testing, was performed on samples from Yellowstone Drive.

The soil samples were visually classified in general accordance with the Unified Soil Classification System (USCS). The estimated USCS group symbol is shown in parentheses following the written description of the various strata on the boring logs. The results of all

laboratory tests are indicated on the boring logs at the depths the samples were obtained and/or on the "Summary of Laboratory Test Results" included in the Appendix, with the exception of the corrosivity testing which is presented in Table 2 of this report.

4.0 GENERAL SUBSURFACE CONDITIONS

The following paragraphs present generalized pavement, soil and groundwater conditions encountered at the test boring locations. For a more detailed description of the subsurface conditions encountered at the site, please refer to the individual soil boring logs.

4.1. Pavement and Soil Conditions

4.1.1. W. Ann Street

Two borings were performed on Ann Street to a depth of 5 feet. Approximately 3 to 4 inches of asphalt pavement was encountered, underlain by 8 to 10 inches of concrete pavement. The concrete pavement was underlain by 0 to 5 inches of sand and gravel aggregate base material. Below the aggregate base material, granular fill material containing trace amounts of organics was encountered to depths of 2 to 3 feet below the pavement surface. The native subgrade soils consisted of silty sand with occasional stiff clay layers. The Standard Penetration Test (SPT) resistance (N) values recorded for the native granular soils ranged from 3 to 24 blows per foot, indicating very loose to medium dense relative densities.

4.1.2. Barton Drive

Eight borings were performed on Barton Drive to a depth of 5 feet. A pavement section consisting of approximately 4 to 6 inches of asphalt with 6 to 12 inches of sand and gravel aggregate base material was typically encountered. The aggregate base at the location of Boring B-8 consisted of 10 inches of crushed limestone. Granular fill materials were encountered to the explored depth of B-2 and to depths of 2¼ to 4 feet within B-4 and B-6 through B-8. The native subgrade soils predominantly consisted of sand with varying amounts of silt and clay. The N-values within the native granular soils typically ranged from 2 to 11 blows per foot, indicating very loose to medium dense relative densities. The relative density of the sand decreased with depth. At the location of B-1, the native subgrade soils consisted of clay. N-values for the native clay

soils ranged from 7 to 10 blows per foot. The unconfined compressive strength of the tested samples typically ranged from 6,000 pounds per square foot (psf) to 7,000 psf, indicating a very stiff consistency.

4.1.3. Depot Street

Four borings were performed on Depot Street to a depth of 5 feet. A pavement section consisting of approximately 7 to 8 inches of asphalt with 4 to 8 inches of sand and gravel aggregate base material was encountered. The pavement sections were underlain by granular fill to depths of about 3 to 4½ feet. The native subgrade soils typically consisted of loose to medium dense silty sand, with N-values in the range of 9 to 22 blows per foot. The native subgrade soils encountered within B-1 through B-3 contained some organics. Loss-on-Ignition (organic content) of the subgrade soils encountered within B-2 was 8.4 percent.

4.1.4. S. Division Street

Nine borings were performed on S. Division Street to a depth of 5 feet. Approximately 2 to 14 inches of asphalt pavement was encountered, underlain by 0 to 12 inches of concrete pavement. Below the concrete pavement, 4 to 10 inches of crushed limestone aggregate base was typically encountered, with the exceptions of Borings B-1, B-2 and B-8 where 6 inches of sand and gravel aggregate base materials were encountered. Below the aggregate base materials encountered within B-1 and B-4, clay fill containing trace amounts of organics was encountered to depths of about 3½ to 4 feet. The native subgrade soils typically consisted of loose to medium dense sand with varying amounts of silt and isolated layers of stiff clay. The N-values recorded within the native granular soils ranged from 5 to 25 blows per foot, indicating loose to medium dense relative densities.

4.1.5. Geddes Avenue

Ten borings were performed on Geddes Avenue to a depth of 5 feet. Approximately 3 to 12 inches of asphalt pavement was encountered, underlain by 0 to 9 inches of concrete pavement. Below the concrete pavement, 3 to 18 inches of sand and gravel

aggregate base materials were typically encountered. The aggregate base material at B-7 consisted of 30 inches of crushed limestone. No aggregate base course was encountered at the location of Borings B-8 and B-9. The native subgrade soils typically consisted of clay and/or sand with varying amounts of silt. N-values for the native clay soils ranged from 6 to 24 blows per foot. The unconfined compressive strength of the tested samples typically ranged from 2,000 psf to more than 9,000 psf, indicating stiff to hard consistencies. The N-values recorded within the native granular soils ranged from 10 to 13 blows per foot, indicating loose to medium dense relative densities.

4.1.6. Green Road

Eighteen borings were performed on Green Road to a depth of 5 feet. Pavement sections consisting of approximately 4 to 8 inches of asphalt with 7 to 12 inches of crushed limestone aggregate base materials were encountered. The pavement sections were underlain by granular fill to depths of about 2 to 2½ feet. The aggregate base and/or granular fill materials encountered at the location of Boring B-1 through B-5, B-7, B-9 and B-15 were underlain by apparently native granular soils to a depth of 2 to 3 feet. N-values ranged from 8 to 22 blows per foot within the native granular soils, indicating loose to medium dense relative densities. The remaining native subgrade soils encountered below the granular fill and native granular subgrade soils typically consisted of clay. The N-values recorded within the native clay soils ranged from 4 to 20 blows per foot. The unconfined compressive strength of the tested samples typically ranged from 1,500 psf to more than 9,000 psf, indicating medium stiff to hard consistencies.

4.1.7. Hiscock Street

Six borings were performed on Hiscock Street to a depth of 5 feet. Approximately 4 to 7 inches of asphalt pavement was encountered. At the location of Boring B-1, the asphalt was underlain by 4 inches of red brick. Approximately 5 to 14 inches of sand and gravel aggregate base material was encountered within the borings. Clay fill was encountered to a depth of about 4 feet within Boring B-4. The native subgrade soils encountered below the clay fill in B-4 and below the aggregate base course in the

remaining borings consisted of sand with varying amounts of silt and clay. The N-values recorded within the native sand layers typically ranged from 7 to 20 blows per foot, indicating loose to medium dense relative densities.

4.1.8. Miller Avenue

Nine borings were performed on Miller Avenue to a depth of 5 feet. Approximately 3 to 12 inches of asphalt pavement was encountered. At the location of Borings B-1, B-8 and B-9, approximately 6 to 16 inches of sand and gravel aggregate base material was encountered; a defined aggregate base course was not observed within the remaining Miller Avenue borings. Below the aggregate base materials encountered within B-8 and B-9, and below the asphalt pavement encountered at B-2 through B-7, granular fill materials were encountered to depths of about 2½ to 4½ feet. Below the aggregate base course encountered within B-1 and below the granular fill materials encountered within the remaining borings, apparently native clay was encountered to the final explored depth of the borings. N-values for the native clay soils typically ranged from 7 to 15 blows per foot. The unconfined compressive strength of the tested samples typically ranged from 4,500 psf to more than 9,000 psf, indicating very stiff to hard consistencies. Within Boring B-6, the unconfined compressive strength was approximately 1,000 psf, indicating a stiff consistency. Trace amounts of organics (Loss-on-Ignition values ranging from 1.6 to 1.8 percent) were observed within the clay subgrade soils at the location of B-1 and B-6.

4.1.9. Moore Street

Two borings were performed on Moore Street to a depth of 5 feet. Approximately 9 to 10 inches of asphalt pavement was encountered. A defined aggregate base course was not observed within the test borings. Below the asphalt pavement, granular fill materials were encountered to depths of about 2½ to 3 feet. The native subgrade soils encountered below the granular fill materials consisted of loose to medium dense sand, with N-values ranging from 4 to 10 blows per foot.

Auger refusal was encountered within Boring B-2 at a depth of about 3 feet. The boring was offset approximately 4 feet from the original borehole and re-drilled.

4.1.10. Newport Road

Nine borings were performed on Newport Road to a depth of 5 feet. Pavement sections consisting of approximately 4 to 7 inches of asphalt with 5 to 20 inches of crushed limestone aggregate base materials were encountered. The pavement sections encountered at the location of Borings B-2, B-4, B-5 and B-9 were underlain by granular fill to depths of about 1½ to 4 feet. The pavement section at the location of B-1 was underlain by granular fill to the final explored depth of the boring. Below the pavement section at the location of Boring B-3, apparently native medium stiff clay containing trace amounts of organics (Loss-on-Ignition value of 3.6 percent) was encountered to a depth of about 4 feet. The native subgrade soils consisted of sand with varying amounts of silt and clay, with isolated layers of clay. The N-values recorded within the native granular soils ranged from 7 to 26 blows per foot, indicating loose to medium dense relative densities. N-values for the native clay soils ranged from 6 to 17 blows per foot. The unconfined compressive strength of the tested samples ranged from 1,000 psf to 1,500 psf, indicating a medium stiff consistency.

4.1.11. Penberton Court/Penberton Drive

One boring was performed on Penberton Court and seven borings were performed on Penberton Drive to a depth of 5 feet. Pavement sections consisting of approximately 4 to 10 inches of asphalt with 4 to 8 inches of sand and gravel aggregate base materials were typically encountered. No defined aggregate base course was observed within Borings B-2, B-4 and B-7 on Penberton Drive. The sand and gravel aggregate base course was underlain by approximately 5 inches of crushed limestone at the location of Penberton Court Boring B-1. At the location of Penberton Court Boring B-1 and B-3, B-5 and B-6 on Penberton Drive, clay fill materials were encountered to 1½ to 3 feet. The native subgrade soils typically consisted of clayey silt/clay, with the exception of Penberton Drive B-6 and B-7 where sand with varying amounts of silt was encountered. The N-values recorded within the native clay soils ranged from 5 to 21

blows per foot. The unconfined compressive strength of the tested samples ranged from 3,000 psf to more than 9,000 psf, indicating stiff to hard consistencies. Within the granular soils, N-values ranged from 12 to 25 blows per foot, indicating a medium dense relative density.

4.1.12. Rock Creek Drive/Court

Six borings were performed on Rock Creek to a depth of 7½ feet. Pavement sections consisting of approximately 2 to 3 inches of asphalt with 9 to 15 inches of sand and gravel aggregate base materials were encountered. The pavement sections at the locations of Borings B-2 and B-4 through B-6 were underlain by sand and clay fill to depths of about 3 to 4 feet. The native subgrade soils consisted of clay and/or sand with varying amounts of silt and clay. N-values for the native clay soils ranged from 9 to 25 blows per foot. The unconfined compressive strength of the tested samples ranged from 3,500 psf to more than 9,000 psf, indicating stiff to hard consistencies. The N-values recorded within the native granular soils ranged from 6 to 15 blows per foot, indicating loose to medium dense relative densities.

4.1.13. S. State Street

Six borings were performed on S. State Street to a depth of 5 feet. At the location of Borings B-1 and B-4 through B-6, 9 to 18 inches of asphalt pavement was encountered. The aggregate base course within B-1, B-5 and B-6 was comprised of 4 to 6 inches of sand and gravel; 9 inches of crushed limestone was encountered below the asphalt pavement at the location of Boring B-4. At the location of Borings B-2 and B-3, approximately 3 to 6 inches of asphalt pavement was encountered, underlain by 4 inches of red brick. The brick was underlain by 3 to 17 inches of sand and gravel aggregate base material. The aggregate base course encountered within B-2 was underlain by 4 inches of concrete pavement. Sand and clay fill materials were encountered to depths of about 4 to 5 feet within B-1, B-5 and B-6. The native subgrade soils consisted of clay and/or sand with varying amounts of silt. The N-values recorded within the native clay soils ranged from 11 to 14 blows per foot. The unconfined compressive strength of the tested samples ranged from 3,000 psf to 6,500

psf, indicating stiff to very stiff consistencies. Within the granular soils, N-values ranged from 4 to 17 blows per foot, indicating loose to medium dense relative densities.

4.1.14. N. Thayer Street

Five borings were performed on N. Thayer Street to a depth of 5 feet. Approximately 3 to 6 inches of asphalt pavement was encountered. Below the asphalt at the location of B-4, approximately 12 inches of concrete pavement was encountered. The asphalt and concrete pavement at the location of Borings B-1, B-4 and B-5 was underlain by 8 to 12 inches of sand and gravel aggregate base material. At the remaining boring locations, the aggregate base course consisted of 3 to 19 inches of crushed limestone. The aggregate base course encountered within B-3 was underlain by granular fill material to a depth of about 4 feet. The native subgrade soils typically consisted of clay and/or sand with varying amounts of silt and clay. N-values for the native clay soils ranged from 5 to 9 blows per foot. The unconfined compressive strength of the tested samples ranged from 1,500 psf to 2,500 psf, indicating medium stiff to stiff consistencies. The N-values recorded within the native granular soils ranged from 5 to 37 blows per foot, indicating loose to dense relative densities.

4.1.15. Yellowstone Drive

Five borings were performed on Yellowstone Drive to a depth of 5 feet. The purpose of these borings was to gather subgrade information pursuant to developing a solution to the recent outbreak of water main breaks in this area. The proposed boring locations were within the lawn extensions (between the sidewalk and the roadway). However, due to utility conflicts, the borings were offset into the roadway.

Approximately 5 to 9 inches of asphalt pavement was encountered at the boring locations. The aggregate base course within B-1 and B-3 through B-5 consisted of 3 to 9 inches of sand and gravel; 7 inches of crushed limestone was encountered below the asphalt pavement at the location of Boring B-2. Clay fill materials were encountered within Borings B-2 and B-4 to depths of about 2 to 3 feet. The fill encountered within B-4 was underlain by 3 inches of wood (possible root), followed by possible clay fill

containing trace amounts of organics. Below the clay fill encountered within B-2 and below the aggregate base course in the remaining borings, native subgrade soils consisting of clay were encountered to the final explored depth of the borings. The N-values recorded within the native clay ranged from 4 to 9 blows per foot. The unconfined compressive strength of the tested samples ranged from 3,000 psf to more than 9,000 psf, indicating stiff to hard consistencies.

Corrosivity testing consisting of pH determination, resistivity testing and oxidation-reduction potential testing were performed in our laboratory on the samples collected at depths between 3½ to 5 feet. The American Water Works Association (AWWA) developed an American National Standard – ANSI/AWWA C105/A21.5 – that addressed the need for polyethylene encasement for ductile iron pipes. The corrosivity testing was performed in accordance with the Soil Survey Tests and Observations section of that standard, which assigns a number of points based on the results of the corrosivity testing. If a soil meets or exceeds a score of 10 points, the standard states that the soils are corrosive to ductile iron pipe and protection is needed. The results of our laboratory corrosivity tests are presented in Table 2 below, along with the points assigned by the standard based on the test results.

Table 2. Corrosivity Test Results for Yellowstone Drive						
Boring Number	Resistivity (ohm-cm)	pH	Oxidation-Reduction Potential (mV)	Sulfides (Negative, Trace or Positive)	Moisture (Poor, Fair or Good Drainage)	Total Points per ANSI/AWWA C105/A21.5
B-1	6,200	6.4	211	Not Tested	Poor	2
B-2	5,100	6.7	243	Not Tested	Poor	2
B-3	5,400	7.0	196	Not Tested	Poor	2
B-4	3,800	6.5	238	Not Tested	Poor	2
B-5	4,800	7.1	251	Not Tested	Poor	2

As directed, the presence of sulfides in the soil samples was not tested. If the soil tests positive for sulfides, the maximum additional points that would be assigned would be 3.5. Therefore, the maximum total point value based on these test results would be 5.5

if sulfides are present in the soil. While indicative of low to moderate corrosivity, this score would not meet the 10 point threshold requiring protection that is presented in the referenced standard.

The above generalized subsurface descriptions are intended to highlight the major stratification features and material characteristics. The individual boring logs should be reviewed for specific information. The stratification depths shown on the boring logs represent the soil conditions at the actual boring locations only. Variations may occur between and/or beyond the boring locations. The nature and extent of any variations may not become evident until the time of construction. In consideration of the current use and previous development of the sites, including utility installations, it would not be unusual for other deposits of fill to be present at the site which were not discovered by the borings. The composition and/or depth of the fill material at this site is expected to be random and may vary in localized areas from the conditions reported herein. If significant variations in the soil conditions or fill material depths are discovered during construction, it should be immediately brought to the attention of CTI before removal.

4.2. Groundwater Conditions

Groundwater observations were conducted during the drilling operations and shortly after completion of the borings. Groundwater seepage was not observed within the test borings either during or after drilling.

The groundwater levels, including perched groundwater accumulations, should be expected to fluctuate seasonally, based on variations in precipitation, evaporation, surface run-off and other factors not evident at the time of our investigation. Typically, groundwater levels and volumes are expected to be higher in the winter and spring seasons compared to the summer and fall months. The actual groundwater levels at the time of construction may vary from those provided herein.

The above soil and groundwater conditions represent a generalized summary of the subsurface conditions and material characteristics. The individual Test Boring Logs should be reviewed for specific information and details relating to specific areas of the site.

5.0 ANALYSIS AND DESIGN RECOMMENDATIONS

At the time this report was prepared, the overall project was in the planning and design stage. The following recommendations have been developed based on the previously assumed/described project characteristics and subsurface conditions. If there is any significant change in the project characteristics from those presented earlier, a review should be made by CTI to determine if any modifications in the evaluations and recommendations included in this report will be required.

As noted previously, several boring locations on Pontiac Trail were staked in direct conflict with utilities. Due to incomplete utility markings, four of the seven borings on Pontiac Trail have been postponed. The information from the seven borings for Pontiac Trail will be transmitted separately once drilling has been completed.

In general, granular and cohesive fill materials containing trace amounts of organics were encountered to varying depths across portions of every explored street. The presence and thickness of fill materials and/or organic-containing soils may vary across the site. If the owner is willing to assume the risks related to decreased pavement life/serviceability by doing so, some or all of the fill could be left in place for pavement support, following proper subgrade preparation activities described in Section 5.1 of this report.

5.1. Site Preparation and Engineered Fill Placement

At the start of earthwork operations, the existing pavement and any other deleterious materials are to be stripped from the new roadway areas. The thickness of the existing pavement, aggregate base and near surface fill layer (where present) should be expected to vary across the site. The depth of unsuitable soil removal should be determined by a representative of CTI at the time of stripping and rough grading.

On Depot Street, the fill was typically underlain by apparently native soils containing some (greater than 5 percent) organics. The subgrade soils on Depot Street will likely require some measure of improvement to provide adequate, long-term pavement support. Improvement measures such as undercutting the upper unsuitable soils and replacing them with engineered

fill or stabilizing the existing subgrade soils with geotextile reinforcement, without performing significant undercuts, should be considered.

Proper evaluation and conditioning (if necessary) of the subgrade should be performed prior to any engineered fill placement. After stripping and excavating to the proposed subgrade level, and after removing any unsuitable materials and underground objects, the rough graded pavement area should be proofrolled with a loaded tandem-axle dump truck or similar rubber-tired vehicle. The purpose of proofrolling operations is to locate areas of excessively loose, soft or weak subgrade soils which may be present at the time of construction. Soils that are observed to rut or deflect excessively during proofrolling should be stabilized by conventional methods such as disking, drying and re-compacting.

If it is not feasible to dry and re-compact the unsuitable subgrade soils due to unfavorable weather conditions, scheduling, etc., it may be necessary to remove such soils and replace them with engineered fill. The thickness of the undercut will depend on the severity of the unstable soils encountered at specific locations. A layer of crushed aggregate may be necessary to stabilize the subgrade before placement of the selected engineered fill material. The use of a geotextile material (e.g. geogrid or fabric) below the crushed aggregate layer could also be considered to provide additional subgrade stability.

It should be noted that the actual locations and depths of any undercutting and/or stabilization should be established in the field at the time of construction. The extent to which yielding subgrades may be a problem is difficult to predict beforehand since it is dependent upon several factors including seasonal conditions, precipitation, construction practices, etc.

Once the site has been evaluated, proofrolled and/or stabilized, the inspected area should not be allowed to remain exposed to wet conditions more than one day or subjected to construction traffic, otherwise a re-evaluation should be made. The site earthwork operations should be carried out during a period of dry weather, if possible. This should minimize potential subgrade problems, although they may not be eliminated. The severity of subgrade instability will depend to a high degree on the weather conditions prevailing during construction.

After subgrade preparation and observation have been completed, any fill placement required to bring the site to the design subgrade level (i.e. the bottom of the proposed aggregate base course) may begin. Any fill placed below the proposed pavement area should be an approved material that is free of topsoil, organics, frozen soil or any other unsuitable material. If granular soils containing greater than 12 percent fines (i.e., silt or clay) are used as fill, close moisture content control will be required to achieve the recommended degree of compaction. Any fill materials encountered at locations other than the boring locations can be further evaluated during site preparation to determine if some of the soils can be reused as engineered fill.

The engineered fill should be placed in uniform horizontal layers not exceeding 8 to 12 inches in loose thickness for clean granular soils and 4 to 6 inches in loose thickness for clay soils (or clayey granular soils exhibiting cohesive characteristics), depending on the type and size of compaction equipment used. The lift thickness for sands that have an appreciable amount of fines should be decreased accordingly. The engineered fill should be compacted to achieve a density of not less than 95 percent of the maximum dry density as determined by the Modified Proctor Compaction Test (ASTM D1557). Also, the upper 12 inches of the subgrade soils should be compacted, prior to any fill placement, to achieve a density of not less than 95 percent of the maximum dry density as determined by the Modified Proctor test. The as-compacted moisture content of the engineered fill should be within 2 to 3 percent of the optimum moisture content for the soil. The placement and testing of engineered fill should be observed and properly documented in the field by CTI.

We recommend that the contract specifications include provisions for moisture conditioning of any on-site soils that are to be used as engineered fill. Some of the natural soils may require moisture conditioning to allow for proper compaction. The success of aeration and drying of clay soils will be dependent on the time of year, the prevailing weather conditions and the contractor's effort. During cold and/or wet periods of the year, the saturated or disturbed clay soils will be more difficult to dry. In this case, the contractor may have to use drier on-site soils or imported sand.

If site grading or other construction activity is planned during cold weather, it is recommended that proper winter construction practices are followed. All snow and ice should be removed

from cut and fill areas prior to grading. Frozen materials should not be used as engineered fill and no fill or pavement should be placed on soils that are frozen or contain frozen material.

5.2. Pavement Design Considerations

The subgrade soils for support of the pavement sections should be prepared in accordance with the methods presented in Section 5.1 of this report. It appears the existing soils and anticipated newly placed engineered fill will be adequate to support the majority of the pavement sections following site preparation activities. Proper evaluation of the subgrade soils should be performed during construction to verify that suitable soil conditions exist for support of the pavement.

The long-term performance of the pavement will typically be a function of the quality of the subgrade soil at the time of construction along with the quality, thickness and strength of the overall pavement section. The most critical portion of the subgrade is the 3 feet immediately beneath the pavement section, which provides the primary strength needed for pavement section support. Soils in a saturated condition, uncontrolled fill and/or organic materials present within the upper 2 to 3 feet of the pavement subgrade can be detrimental if the design does not account for this substandard soil condition, especially during the spring freeze-thaw cycles.

The pavement system should be properly drained to reduce the potential for weakening the subgrade. Provisions should be made to prevent surface run-off water from accumulating within the aggregate base course of the pavement. The pavement and underlying subgrade should be suitably crowned or sloped to promote effective surface drainage and prevent water ponding.

We anticipate that the pavement surface will drain via storm sewers (where present) and via run-off methods where storm sewers are not available. Where the reconstruction project includes the installation of a storm sewer system, finger drains should be installed at all catch basin locations to provide drainage for surface water that may become trapped in the pavement aggregate base course. At a minimum, a system of finger drains or stub drains should be placed around all catch basins within the pavement areas to minimize the accumulation of water in the frost susceptible subgrade soils. These under drains should be installed below the

aggregate base course layer of the pavement system and be properly protected with free-draining coarse aggregate material and filter fabric.

All pavements require regular maintenance and occasional repairs to keep them in a serviceable condition. Of particular value is timely sealing of joints and cracks, which if left unrepaired, can serve to permit water to enter the pavement section and cause rapid deterioration of the pavement during freeze-thaw cycles. The need for such routine maintenance and repair is not necessarily indicative of premature pavement failure. However, if appropriate maintenance and repairs are not performed on a timely basis, the serviceable life of the pavement can be reduced significantly.

Actual pavement section thickness should be provided by the design civil engineer based on design traffic loads and volume and the owner's design life requirements. All pavement materials and procedures should conform to standard MDOT, City of Ann Arbor or appropriate local municipal agency requirements.

Based on the results of the soil borings performed, Resilient Modulus values (M_r) for the encountered soils have been estimated and are presented in Table 3, along with a summary of the encountered pavement and subgrade conditions.

Table 3. Summary of Encountered Conditions and Estimated Soil Properties

Street	Limits	Pavement Thickness (in)		Aggregate Base Thickness (in)		Subgrade Soil Description	Estimated Resilient Modulus, M_r (psi)
		Asphalt	Concrete	Natural Aggregate	Crushed Limestone		
W. Ann	First Avenue to N. Main	3-4	8-10	0-5	0	Sand Fill	7,500
Barton	Pontiac Trail to Plymouth	4-6	0	6-12	10 (at B-8)	Sand Fill/Sand	7,500
Depot	N. Main to Carey	7-8	0	4-8	0	Sand Fill/ Sand and Clay with organics	3,500
S. Division	E. Huron to Packard	2-14	0-12	6 (B-1, B-2 & B-8)	4-10	Silty Sand/Clay	6,000
Geddes	Observatory to Highland	3-12	0-9	0-18	30 (B-7)	Clay Fill/Clay/ Silty Sand	6,000
Green	Nixon to 3344 Green Rd	4-8	0	0	7-12	Sand Fill/Sand/Clay	6,000
Hiscock	Brooks to Spring	4-7	(4 of brick at B-1)	5-14	0	Clay Fill (B-4)/ Sand/Clayey Sand	5,500
Miller	City Limits to Maple	3-12	0	0-16	0	Sand Fill/Clay	6,000
Moore	Pontiac Trail to Broadway	9-10	0	0	0	Sand Fill/Sand	6,500
Newport	City Limits to Warrington	4-7	0	0	5-20	Sand Fill/Sand/Clay	4,000
Penberton Ct	Addresses 3925 to 3935	5	0	5	5	Clay Fill	4,000
Penberton Dr	Fox Hunt to Waldenwood (east)	4-10	0	0-8	0	Clay Fill/Clay/ Clayey Silt/Sand	4,500
Rock Creek	Northern End to Huntington	2-3	0	9-15	0	Sand Fill/Clay Fill/ Clay/Sand	5,500
S. State	Washington to S. University	3-18	(4 of brick at B-2 and B-3)	3-17	9 (B-4)	Sand Fill/Clay Fill/ Clay/Sand	5,500
N. Thayer	E. Huron to Kingsley	3-6	12 (at B-4)	8-12 (B-1, B-4 & B-5)	3-19 (B-2 & B-3)	Sand Fill/Clay/ Silty & Clayey Sand	6,000
Yellowstone	Bluett to Bluett	5-9	0	3-9	7 (B-2_)	Clay Fill/Clay	4,500

6.0 GENERAL CONSTRUCTION PROCEDURES / RECOMMENDATIONS

6.1. General

Experience indicates that variations in soil conditions are encountered during construction. In order to permit correlation between the soil boring data and the actual soil conditions encountered during construction, it is recommended that a continuous inspection and review of the soil related phases of construction work be carried out. We recommend the site preparation activities, engineered fill placement and pavement construction be observed by a qualified engineering technician. The technician should perform the appropriate type and number of field tests needed to verify compliance with construction specifications and that the pavement subgrade soils are suitable.

The existing silty soils at the site could be potentially troublesome for some earthwork operations, depending on the prevailing moisture content. These soils have relatively poor drainage characteristics and are susceptible to ponding, subsequent softening and pumping due to construction traffic. During a wet season or periods of heavy precipitation, the silty and clayey subgrade soils may become unstable and provide limited support for some rubber-tired construction equipment. If pumping of the subgrade occurs due to construction traffic, an evaluation of the site and construction procedures should be made by a geotechnical engineer.

6.2. Groundwater Control

Based on the observed groundwater conditions in the test borings, no significant groundwater related problems are anticipated during pavement construction. However, the conditions encountered at the majority of the boring locations are conducive to the development of perched water accumulations within the granular soils. If perched accumulations occur, some groundwater seepage could be encountered.

Proper groundwater control measures should be maintained during all earthwork activities in order to limit the disturbance of the subgrade soils. These measures should include a provision of temporary drainage ditches to discharge any perched water outside the construction area.

For relatively shallow excavations, it appears that minor perched groundwater accumulations, if encountered, should be controllable by conventional pumping methods from standard sump pits extending into the natural clay soils.

Any groundwater related problems should be evaluated in the field by a qualified geotechnical engineer so that the best remedial measures can be determined.

APPENDIX

Boring Logs
Summary of Laboratory Test Results
General Notes for Soil Classification

Boring Logs



CTI and Associates Inc

BORING NUMBER: Division B-1

PAGE 1 OF 1

CLIENT City of Ann Arbor
PROJECT NUMBER 3122040060-1
DATE STARTED 10/10/12 **COMPLETED** 10/10/12
DRILLING CONTRACTOR Stearns Drilling
DRILLING METHOD 2-1/4 inch HSA
LOGGED BY G. Geerlings **CHECKED BY** T. Marsik
NOTES Boring backfilled with auger cuttings and patched.

PROJECT NAME 2012 Ann Arbor Misc. Geotechnical Services - North Area Borings
PROJECT LOCATION Ann Arbor, Michigan
GROUND ELEVATION N/A
GROUND WATER LEVELS:
DURING DRILLING None
AFTER DRILLING None
COLLAPSE DEPTH 3' 6"

DEPTH (ft)	GRAPHIC LOG	MATERIAL DESCRIPTION	SAMPLE TYPE NUMBER	RECOVERY % (RQD)	BLOW COUNTS (N VALUE)	POCKET PEN. (tsf) UNC. STRENGTH (psf)	NATURAL MOISTURE CONTENT (%)	▲ SPT N VALUE ▲		
								20	40	60
0.0		6 inches of ASPHALT PAVEMENT								
		6 inches of CONCRETE PAVEMENT								
		6 inches of brown moist fine to medium SAND with some gravel and silt - (FILL)								
		Reddish-brown moist loose silty fine SAND with some gravel and clay - (SM)	SS 1	100	5-3-7 (10)					
2.5										
			SS 2	56	3-3-2 (5)					
5.0										

Bottom of borehole at 5.0 feet.

Boring performed 8' east of curb, 50' north of Washington Street



CTI and Associates Inc

BORING NUMBER: Division B-2

CLIENT City of Ann Arbor
PROJECT NUMBER 3122040060-1
DATE STARTED 10/10/12 **COMPLETED** 10/10/12
DRILLING CONTRACTOR Stearns Drilling
DRILLING METHOD 2-1/4 inch HSA
LOGGED BY G. Geerlings **CHECKED BY** T. Marsik
NOTES Boring backfilled with auger cuttings and patched.

PROJECT NAME 2012 Ann Arbor Misc. Geotechnical Services - North Area Borings
PROJECT LOCATION Ann Arbor, Michigan
GROUND ELEVATION N/A
GROUND WATER LEVELS:
DURING DRILLING None
AFTER DRILLING None
COLLAPSE DEPTH 3' 6"

DEPTH (ft)	GRAPHIC LOG	MATERIAL DESCRIPTION	SAMPLE TYPE NUMBER	RECOVERY % (RQD)	BLOW COUNTS (N VALUE)	POCKET PEN. (tsf) UNC. STRENGTH (psf)	NATURAL MOISTURE CONTENT (%)	▲ SPT N VALUE ▲						
								20	40	60	80			
0.0		6 inches of ASPHALT PAVEMENT												
		6 inches of CONCRETE PAVEMENT												
		6 inches of brown moist fine to medium SAND with some gravel and silt - (FILL)												
		Brown moist medium dense silty fine SAND with some gravel and clay and occasional clay lenses - (SM)	SS 1	100	5-6-4 (10)									
2.5														
			SS 2	61	4-4-6 (10)									
5.0														

Bottom of borehole at 5.0 feet.

Boring performed 10' east of curb, 90' north of Liberty Street



CTI and Associates Inc

BORING NUMBER: Division B-3

PAGE 1 OF 1

CLIENT City of Ann Arbor
PROJECT NUMBER 3122040060-1
DATE STARTED 10/10/12 **COMPLETED** 10/10/12
DRILLING CONTRACTOR Stearns Drilling
DRILLING METHOD 2-1/4 inch HSA
LOGGED BY G. Geerlings **CHECKED BY** T. Marsik
NOTES Boring backfilled with auger cuttings and patched.

PROJECT NAME 2012 Ann Arbor Misc. Geotechnical Services - North Area Borings
PROJECT LOCATION Ann Arbor, Michigan
GROUND ELEVATION N/A
GROUND WATER LEVELS:
DURING DRILLING None
AFTER DRILLING None
COLLAPSE DEPTH 3' 6"

DEPTH (ft)	GRAPHIC LOG	MATERIAL DESCRIPTION	SAMPLE TYPE NUMBER	RECOVERY % (RQD)	BLOW COUNTS (N VALUE)	POCKET PEN. (tsf) UNC. STRENGTH (psf)	NATURAL MOISTURE CONTENT (%)	▲ SPT N VALUE ▲		
								20	40	60
0.0		4 inches of ASPHALT PAVEMENT								
		10 inches of CONCRETE PAVEMENT								
		10 inches of gray moist crushed LIMESTONE - (FILL)								
2.5		Brown moist medium dense fine to medium SAND with some gravel and trace of silt - (SP)	SS 1	100	11-8-9 (17)					
			SS 2	100	10-5-6 (11)					
5.0										

Bottom of borehole at 5.0 feet.

Boring performed 8' west of curb, at 307 S. Division Street



CTI and Associates Inc

BORING NUMBER: Division B-4

PAGE 1 OF 1

CLIENT City of Ann Arbor
PROJECT NUMBER 3122040060-1
DATE STARTED 10/10/12 **COMPLETED** 10/10/12
DRILLING CONTRACTOR Stearns Drilling
DRILLING METHOD 2-1/4 inch HSA
LOGGED BY G. Geerlings **CHECKED BY** T. Marsik
NOTES Boring backfilled with auger cuttings and patched.

PROJECT NAME 2012 Ann Arbor Misc. Geotechnical Services - North Area Borings
PROJECT LOCATION Ann Arbor, Michigan
GROUND ELEVATION N/A
GROUND WATER LEVELS:
DURING DRILLING None
AFTER DRILLING None
COLLAPSE DEPTH 3' 6"

DEPTH (ft)	GRAPHIC LOG	MATERIAL DESCRIPTION	SAMPLE TYPE NUMBER	RECOVERY % (RQD)	BLOW COUNTS (N VALUE)	POCKET PEN. (tsf) UNC. STRENGTH (psf)	NATURAL MOISTURE CONTENT (%)	▲ SPT N VALUE ▲										
								20	40	60	80							
0.0		4 inches of ASPHALT PAVEMENT																
		8 inches of CONCRETE PAVEMENT																
		6 inches of gray moist crushed LIMESTONE - (FILL)																
2.5		Brown moist medium dense fine to medium SAND with some gravel and trace of silt - (SP)	SS 1	100	8-9-8 (17)													
5.0		Brown moist medium dense silty fine to medium SAND with some gravel and clay - (SM)	SS 2	67	6-8-10 (18)													

Bottom of borehole at 5.0 feet.

Boring performed 8' west of curb, at 321 S. Division Street



CTI and Associates Inc

BORING NUMBER: Division B-5

PAGE 1 OF 1

CLIENT City of Ann Arbor
PROJECT NUMBER 3122040060-1
DATE STARTED 10/10/12 **COMPLETED** 10/10/12
DRILLING CONTRACTOR Stearns Drilling
DRILLING METHOD 2-1/4 inch HSA
LOGGED BY G. Geerlings **CHECKED BY** T. Marsik
NOTES Boring backfilled with auger cuttings and patched.

PROJECT NAME 2012 Ann Arbor Misc. Geotechnical Services - North Area Borings
PROJECT LOCATION Ann Arbor, Michigan
GROUND ELEVATION N/A
GROUND WATER LEVELS:
DURING DRILLING None
AFTER DRILLING None
COLLAPSE DEPTH 3' 6"

DEPTH (ft)	GRAPHIC LOG	MATERIAL DESCRIPTION	SAMPLE TYPE NUMBER	RECOVERY % (RQD)	BLOW COUNTS (N VALUE)	POCKET PEN. (tsf) UNC. STRENGTH (psf)	NATURAL MOISTURE CONTENT (%)	▲ SPT N VALUE ▲		
								20	40	60
0.0		2 inches of ASPHALT PAVEMENT 12 inches of CONCRETE PAVEMENT								
		5 inches of moist gray crushed LIMESTONE - (FILL)								
2.5		Brown moist medium dense fine to medium SAND with some gravel and trace of silt - (SP)	SS 1	100	8-13-12 (25)					
5.0			SS 2	89	4-5-5 (10)					

Bottom of borehole at 5.0 feet.

Boring performed 8' west of curb, 10' south of driveway to 335 S. Division Street



CTI and Associates Inc

BORING NUMBER: Division B-6

PAGE 1 OF 1

CLIENT City of Ann Arbor
PROJECT NUMBER 3122040060-1
DATE STARTED 10/10/12 **COMPLETED** 10/10/12
DRILLING CONTRACTOR Stearns Drilling
DRILLING METHOD 2-1/4 inch HSA
LOGGED BY G. Geerlings **CHECKED BY** T. Marsik
NOTES Boring backfilled with auger cuttings and patched.

PROJECT NAME 2012 Ann Arbor Misc. Geotechnical Services - North Area Borings
PROJECT LOCATION Ann Arbor, Michigan
GROUND ELEVATION N/A
GROUND WATER LEVELS:
DURING DRILLING None
AFTER DRILLING None
COLLAPSE DEPTH 3' 6"

DEPTH (ft)	GRAPHIC LOG	MATERIAL DESCRIPTION	SAMPLE TYPE NUMBER	RECOVERY % (RQD)	BLOW COUNTS (N VALUE)	POCKET PEN. (tsf) UNC. STRENGTH (psf)	NATURAL MOISTURE CONTENT (%)	▲ SPT N VALUE ▲	
								PL	MC LL
0.0		8 inches of ASPHALT PAVEMENT						20	40 60 80
		4 inches of CONCRETE PAVEMENT						20	40 60 80
		6 inches of dark gray moist crushed LIMESTONE - (FILL)						20	40 60 80
2.5		Reddish-brown moist stiff sandy CLAY with silt and some gravel - (CL)	SS 1	100	7-3-4 (7)		13	20	40 60 80
5.0		Brown moist loose clayey fine to medium SAND with some gravel - (SC)	SS 2	17	3-3-6 (9)			20	40 60 80

Bottom of borehole at 5.0 feet.

Boring performed 18' west of curb, at 413 S. Division Street



CTI and Associates Inc

BORING NUMBER: Division B-7

CLIENT City of Ann Arbor
PROJECT NUMBER 3122040060-1
DATE STARTED 10/10/12 **COMPLETED** 10/10/12
DRILLING CONTRACTOR Stearns Drilling
DRILLING METHOD 2-1/4 inch HSA
LOGGED BY G. Geerlings **CHECKED BY** T. Marsik
NOTES Boring backfilled with auger cuttings and patched.

PROJECT NAME 2012 Ann Arbor Misc. Geotechnical Services - North Area Borings
PROJECT LOCATION Ann Arbor, Michigan
GROUND ELEVATION N/A
GROUND WATER LEVELS:
DURING DRILLING None
AFTER DRILLING None
COLLAPSE DEPTH 3' 6"

DEPTH (ft)	GRAPHIC LOG	MATERIAL DESCRIPTION	SAMPLE TYPE NUMBER	RECOVERY % (RQD)	BLOW COUNTS (N VALUE)	POCKET PEN. (tsf) UNC. STRENGTH (psf)	NATURAL MOISTURE CONTENT (%)	▲ SPT N VALUE ▲	
								20	40
0.0		14 inches of ASPHALT PAVEMENT							
2.5		6 inches of dark brown moist fine to medium SAND with some gravel and silt - (FILL) Dark brown to reddish-brown moist sandy CLAY with silt, some gravel and traces of sand and organics - (FILL)	SS 1	100	2-2-2 (4)				
5.0		Brown moist loose fine to medium SAND with some gravel and silt - (SP-SM)	SS 2	89	2-3-4 (7)				

Bottom of borehole at 5.0 feet.

Boring performed 18' west of curb, at entrance to 443 S. Division Street



CTI and Associates Inc

BORING NUMBER: Division B-8

PAGE 1 OF 1

CLIENT City of Ann Arbor
PROJECT NUMBER 3122040060-1
DATE STARTED 10/10/12 **COMPLETED** 10/10/12
DRILLING CONTRACTOR Stearns Drilling
DRILLING METHOD 2-1/4 inch HSA
LOGGED BY G. Geerlings **CHECKED BY** T. Marsik
NOTES Boring backfilled with auger cuttings and patched.

PROJECT NAME 2012 Ann Arbor Misc. Geotechnical Services - North Area Borings
PROJECT LOCATION Ann Arbor, Michigan
GROUND ELEVATION N/A
GROUND WATER LEVELS:
DURING DRILLING None
AFTER DRILLING None
COLLAPSE DEPTH 3' 6"

DEPTH (ft)	GRAPHIC LOG	MATERIAL DESCRIPTION	SAMPLE TYPE NUMBER	RECOVERY % (RQD)	BLOW COUNTS (N VALUE)	POCKET PEN. (tsf) UNC. STRENGTH (psf)	NATURAL MOISTURE CONTENT (%)	▲ SPT N VALUE ▲									
								20	40	60	80						
0.0		8 inches of ASPHALT PAVEMENT															
		6 inches of CONCRETE PAVEMENT															
		4 inches of dark gray moist crushed LIMESTONE - (FILL)															
2.5		Brown moist loose fine to coarse SAND with gravel and some silt - (SP-SM)	SS 1	94	6-5-4 (9)												
5.0			SS 2	33	3-3-3 (6)												

Bottom of borehole at 5.0 feet.

Boring performed 18' west of curb, 15' south of driveway to 522 S. Division Street



CTI and Associates Inc

BORING NUMBER: Division B-9

PAGE 1 OF 1

CLIENT City of Ann Arbor
PROJECT NUMBER 3122040060-1
DATE STARTED 10/10/12 **COMPLETED** 10/10/12
DRILLING CONTRACTOR Stearns Drilling
DRILLING METHOD 2-1/4 inch HSA
LOGGED BY G. Geerlings **CHECKED BY** T. Marsik
NOTES Boring backfilled with auger cuttings and patched.

PROJECT NAME 2012 Ann Arbor Misc. Geotechnical Services - North Area Borings
PROJECT LOCATION Ann Arbor, Michigan
GROUND ELEVATION N/A
GROUND WATER LEVELS:
DURING DRILLING None
AFTER DRILLING None
COLLAPSE DEPTH 3' 6"

DEPTH (ft)	GRAPHIC LOG	MATERIAL DESCRIPTION	SAMPLE TYPE NUMBER	RECOVERY % (RQD)	BLOW COUNTS (N VALUE)	POCKET PEN. (tsf) UNC. STRENGTH (psf)	NATURAL MOISTURE CONTENT (%)	▲ SPT N VALUE ▲	
								20	40 60 80
0.0		5 inches of ASPHALT PAVEMENT						PL	MC LL
		12 inches of CONCRETE PAVEMENT						20 40 60 80	
		7 inches of gray moist crushed LIMESTONE - (FILL)	SS 1	100	6-7-7 (14)				
2.5		Brown moist medium dense fine to coarse SAND with gravel and some silt - (SP-SM)							
		Brown moist medium density silty fine to medium SAND with some gravel and clay - (SM)	SS 2	100	4-7-10 (17)				
5.0									

Bottom of borehole at 5.0 feet.

Boring performed 4' west of curb, at entrance to Krazy Jim's Blimpy Burger

CITY OF ANN ARBOR LIVING WAGE ORDINANCE

RATE EFFECTIVE APRIL 30, 2015 - ENDING APRIL 29, 2016

\$12.81 per hour

If the employer provides health care benefits*

\$14.30 per hour

If the employer does **NOT** provide health care benefits*

Employers providing services to or for the City of Ann Arbor or recipients of grants or financial assistance from the City of Ann Arbor for a value of more than \$10,000 in a twelve-month period of time must pay those employees performing work on a City of Ann Arbor contract or grant, the above living wage.

ENFORCEMENT

The City of Ann Arbor may recover back wages either administratively or through court action for the employees that have been underpaid in violation of the law. Persons denied payment of the living wage have the right to bring a civil action for damages in addition to any action taken by the City.

Violation of this Ordinance is punishable by fines of not more than \$500/violation plus costs, with each day being considered a separate violation. Additionally, the City of Ann Arbor has the right to modify, terminate, cancel or suspend a contract in the event of a violation of the Ordinance.

* Health Care benefits include those paid for by the employer or making an employer contribution toward the purchase of health care. The employee contribution must not exceed \$.50 an hour for an average work week; and the employer cost or contribution must equal no less than \$1/hr for the average work week.

The Law Requires Employers to Display This Poster Where Employees Can Readily See It.

**For Additional Information or to File a Complaint Contact:
Mark Berryman at 734/794-6500 or mberryman@a2gov.org**



Vendor Conflict of Interest Disclosure Form

All vendors interested in conducting business with the City of Ann Arbor must complete and return the Vendor Conflict of Interest Disclosure Form in order to be eligible to be awarded a contract. Please note that all vendors are subject to comply with the City of Ann Arbor's conflict interest policies as stated within the certification section below.

If a vendor has a relationship with a City of Ann Arbor official or employee, an immediate family member of a City of Ann Arbor official or employee, the vendor shall disclose the information required below.

Certification: I hereby certify that to my knowledge, there is no conflict of interest involving the vendor named below:

1. No City official or employee or City employee's immediate family member has an ownership interest in vendor's company or is deriving personal financial gain from this contract.
2. No retired or separated City official or employee who has been retired or separated from the City for less than one (1) year has an ownership interest in vendor's Company.
3. No City employee is contemporaneously employed or prospectively to be employed with the vendor.
4. Vendor hereby declares it has not and will not provide gifts or hospitality of any dollar value or any other gratuities to any City employee or elected official to obtain or maintain a contract.
5. Please note any exceptions below:

Vendor Name	Vendor Phone Number
Conflict of Interest Disclosure *	
Name of City of Ann Arbor employees, elected officials, or immediate family members with whom there maybe a potential conflict of interest.	<input type="checkbox"/> Relationship to employee _____ <input type="checkbox"/> Interest in vendor's company _____ <input type="checkbox"/> Other _____

*Disclosing a potential conflict of interest does not disqualify vendors. In the event vendors do not disclose potential conflicts of interest and they are detected by the City, vendor will be exempt from doing business with the City.

I certify that the information provided is true and correct by my signature below:

Signature of Vendor Authorized Representative	Date	Printed Name of Vendor Authorized Representative

PROCUREMENT USE ONLY

- Yes, named employee was involved in Bid / Proposal process.
- No, named employee was not involved in procurement process or decision.

**CITY OF ANN ARBOR
DECLARATION OF COMPLIANCE**

Non-Discrimination Ordinance

The “non discrimination by city contractors” provision of the City of Ann Arbor Non-Discrimination Ordinance (Ann Arbor City Code Chapter 112, Section 9:158) requires all contractors proposing to do business with the City to treat employees in a manner which provides equal employment opportunity and does not discriminate against any of their employees, any City employee working with them, or any applicant for employment on the basis of actual or perceived age, arrest record, color, disability, educational association, familial status, family responsibilities, gender expression, gender identity, genetic information, height, HIV status, marital status, national origin, political beliefs, race, religion, sex, sexual orientation, source of income, veteran status, victim of domestic violence or stalking, or weight. It also requires that the contractors include a similar provision in all subcontracts that they execute for City work or programs.

In addition the City Non-Discrimination Ordinance requires that all contractors proposing to do business with the City of Ann Arbor must satisfy the contract compliance administrative policy adopted by the City Administrator. A copy of that policy may be obtained from the Purchasing Manager

The Contractor agrees:

- (a) To comply with the terms of the City of Ann Arbor’s Non-Discrimination Ordinance and contract compliance administrative policy.
- (b) To post the City of Ann Arbor’s Non-Discrimination Ordinance Notice in every work place or other location in which employees or other persons are contracted to provide services under a contract with the City.
- (c) To provide documentation within the specified time frame in connection with any workforce verification, compliance review or complaint investigation.
- (d) To permit access to employees and work sites to City representatives for the purposes of monitoring compliance, or investigating complaints of non-compliance.

The undersigned states that he/she has the requisite authority to act on behalf of his/her employer in these matters and has offered to provide the services in accordance with the terms of the Ann Arbor Non-Discrimination Ordinance. The undersigned certifies that he/she has read and is familiar with the terms of the Non-Discrimination Ordinance, obligates the Contractor to those terms and acknowledges that if his/her employer is found to be in violation of Ordinance it may be subject to civil penalties and termination of the awarded contract.

Company Name

Signature of Authorized Representative

Date

Print Name and Title

Address, City, State, Zip

Phone/Email address

Questions about the Notice or the City Administrative Policy, Please contact:
Procurement Office of the City of Ann Arbor
(734) 794-6500

CITY OF ANN ARBOR NON-DISCRIMINATION ORDINANCE

Relevant provisions of Chapter 112, Nondiscrimination, of the Ann Arbor City Code are included below. You can review the entire ordinance at [www. a2gov.org/departments/city-clerk](http://www.a2gov.org/departments/city-clerk)

Intent: It is the intent of the city that no individual be denied equal protection of the laws; nor shall any individual be denied the enjoyment of his or her civil or political rights or be discriminated against because of actual or perceived age, arrest record, color, disability, educational association, familial status, family responsibilities, gender expression, gender identity, genetic information, height, HIV status, marital status, national origin, political beliefs, race, religion, sex, sexual orientation, source of income, veteran status, victim of domestic violence or stalking, or weight.

Discriminatory Employment Practices: No person shall discriminate in the hire, employment, compensation, work classifications, conditions or terms, promotion or demotion, or termination of employment of any individual. No person shall discriminate in limiting membership, conditions of membership or termination of membership in any labor union or apprenticeship program.

Discriminatory Effects: No person shall adopt, enforce or employ any policy or requirement which has the effect of creating unequal opportunities according to actual or perceived age, arrest record, color, disability, educational association, familial status, family responsibilities, gender expression, gender identity, genetic information, height, HIV status, marital status, national origin, political beliefs, race, religion, sex, sexual orientation, source of income, veteran status, victim of domestic violence or stalking, or weight for an individual to obtain housing, employment or public accommodation, except for a bona fide business necessity. Such a necessity does not arise due to a mere inconvenience or because of suspected objection to such a person by neighbors, customers or other persons.

Nondiscrimination by City Contractors: All contractors proposing to do business with the City of Ann Arbor shall satisfy the contract compliance administrative policy adopted by the City Administrator in accordance with the guidelines of this section. All city contractors shall ensure that applicants are employed and that employees are treated during employment in a manner which provides equal employment opportunity and tends to eliminate inequality based upon any classification protected by this chapter. All contractors shall agree not to discriminate against an employee or applicant for employment with respect to hire, tenure, terms, conditions, or privileges of employment, or a matter directly or indirectly related to employment, because of any applicable protected classification. All contractors shall be required to post a copy of Ann Arbor's Non-Discrimination Ordinance at all work locations where its employees provide services under a contract with the city.

Complaint Procedure: If any individual has a grievance alleging a violation of this chapter, he/she has 180 calendar days from the date of the individual's knowledge of the allegedly discriminatory action or 180 calendar days from the date when the individual should have known of the alleged discriminatory action to file a complaint with the city's Human Rights Commission. If an individual fails to file a complaint alleging a violation of this chapter within the specified time frame, the complaint will not be considered by the Human Rights Commission. The complaint should be made in writing to the Human Rights Commission. The complaint may be filed in person with the City Clerk, by e-mail at aahumanrightscommission@gmail.com, or by mail (Ann Arbor Human Rights Commission, PO Box 8647, Ann Arbor, MI 48107). The complaint must contain information about the alleged discrimination, such as name, address, phone number of the complainant and location, date and description of the alleged violation of this chapter.

Private Actions For Damages or Injunctive Relief: To the extent allowed by law, an individual who is the victim of discriminatory action in violation of this chapter may bring a civil action for appropriate injunctive relief or damages or both against the person(s) who acted in violation of this chapter

THIS IS AN OFFICIAL GOVERNMENT NOTICE AND
MUST BE DISPLAYED WHERE EMPLOYEES CAN READILY SEE IT.