

CITY OF ANN ARBOR
INVITATION TO BID



Street Resurfacing - 2016

ITB No. 4422

Due Date: Tuesday, March 15, 2016, by 10:00 a.m.

Public Services Area
Project Management Services Unit

Issued By:

City of Ann Arbor
Procurement Unit
301 E. Huron Street
Ann Arbor, MI 48104

TABLE OF CONTENTS

TABLE OF CONTENTS..... TC-1
NOTICE OF PRE-BID CONFERENCE NP-1
INSTRUCTIONS TO BIDDERS IB-1 to 5
INVITATION TO BID ITB-1 to 3
BID FORMS BF-1 to 11
CONTRACT C-1 to 3
BOND FORMS B-1 to 2
GENERAL CONDITIONS GC-1-19
STANDARD SPECIFICATIONS SS-1
DETAILED SPECIFICATIONS DS-1 to 117
APPENDICES APDX-1

ATTACHMENTS

- City of Ann Arbor Prevailing Wage Declaration Form*
- City of Ann Arbor Living Wage Forms*
- City of Ann Arbor Vendor Conflict of Interest Disclosure Form*
- City of Ann Arbor Non-Discrimination Ordinance Declaration of Compliance Form*
- City of Ann Arbor Non-Discrimination Ordinance Notice*

NOTICE OF PRE-BID CONFERENCE

A pre-bid conference for this project will be held on Monday, March 7, 2016 at 1:30 p.m. in the 1st Floor South Conference Room of Guy C. Larcom City Hall, 301 East Huron Street, Ann Arbor, Michigan.

Attendance at this conference is optional, but highly recommended. Administrative and technical questions regarding this project will be answered at this time. The pre-bid conference is for information only. Any answers furnished will not be official until verified in writing by the Financial Services Area, Procurement Unit. Answers that change or substantially clarify the bid will be affirmed in an addendum.

INSTRUCTIONS TO BIDDERS

General

Work to be done under this Contract is generally described through the detailed specifications and must be completed fully in accordance with the contract documents. All work to be done under this Contract is located in or near the City of Ann Arbor.

Any Bid which does not conform fully to these instructions may be rejected.

Preparation of Bids

Bids should be prepared providing a straight-forward, concise description of the Bidder's ability to meet the requirements of the ITB. Bids shall be written in ink or typewritten. No erasures are permitted. Mistakes may be crossed out and corrected and must be initialed and dated in ink by the person signing the Bid.

Bids must be submitted on the "Bid Forms" provided with each blank properly filled in. If forms are not fully completed it may disqualify the bid. No alternative bid will be considered unless alternative bids are specifically requested. If alternatives are requested, any deviation from the specification must be fully described, in detail on the "Alternate" section of Bid form.

Each person signing the Bid certifies that he/she is the person in the Bidder's firm/organization responsible for the decision as to the fees being offered in the Bid and has not and will not participated in any action contrary to the terms of this provision.

Questions or Clarification on ITB Specifications

All questions regarding this ITB shall be submitted via email. Emailed questions and inquires will be accepted from any and all prospective Bidders in accordance with the terms and conditions of the ITB.

All questions shall be due on or before Tuesday, March 8, 2016 at 12:00 p.m., and should be addressed as follows:

Specification/Scope of Work questions emailed to ddykman@a2gov.org

Bid Process and HR Compliance questions emailed to cspencer@a2gov.org

Any error, omissions or discrepancies in the specifications discovered by a prospective contractor and/or service provider shall be brought to the attention of David Dykman at ddykman@a2gov.org immediately after discovery. Further, the contractor and/or service provider shall not be allowed to take advantage of errors, omissions or discrepancies in the specifications.

Addenda

If it becomes necessary to revise any part of the ITB, notice of the Addendum will be posted to Michigan Inter-governmental Trade Network (MITN) www.mitn.info and/or City of Ann Arbor web site www.a2gov.org for all parties to download.

Each Bidder must in its Bid, to avoid any miscommunications, acknowledge all addenda which it has received, but the failure of a Bidder to receive, or acknowledge receipt of; any addenda shall not relieve the Bidder of the responsibility for complying with the terms thereof.

The City will not be bound by oral responses to inquiries or written responses other than written addenda.

Bid Submission

All Bids are due and must be delivered to the City of Ann Arbor Procurement Unit on or before Tuesday, March 15, 2016 by 10:00 a.m. Bids submitted late or via oral, telephonic, telegraphic, electronic mail or facsimile **will not** be considered or accepted.

Each Bidder must submit one (1) original Bid and (1) Bid copies in a sealed envelope clearly marked: **ITB No. 4422: Street Resurfacing - 2016.**

Bids must be addressed and delivered to:

City of Ann Arbor
Procurement Unit,
c/o Customer Services, 1st Floor
301 East Huron Street
P.O. Box 8647
Ann Arbor, MI 48107

All Bids received on or before the Due Date will be publicly opened and recorded immediately. No immediate decisions are rendered.

The following forms provided within this ITB Document must be included in submitted bids.

- **City of Ann Arbor Prevailing Wage Declaration of Compliance**
- **City of Ann Arbor Living Wage Ordinance Declaration of Compliance**
- **Vendor Conflict of Interest Disclosure Form**
- **City of Ann Arbor Non-Discrimination Ordinance Declaration of Compliance**

Bids that fail to provide these completed forms listed above upon bid opening will be rejected as non-responsive and will not be considered for award.

Hand delivered bids will be date/time stamped/signed by the Procurement Unit at the address above in order to be considered. Normal business hours are 9:00 a.m. to 3:00 p.m. Monday through Friday, excluding Holidays. The City will not be liable to any Bidder for any unforeseen circumstances, delivery or postal delays. Postmarking to the Due Date will not substitute for receipt of the Bid. Each Bidder is responsible for submission of their Bid.

Additional time for submission of bids past the stated due date and time will not be granted to a single Bidder; however, additional time may be granted to all Bidders when the City determines in its sole discretion that circumstances warrant it.

Award

The City intends to award a Contract(s) to the lowest responsible Bidder(s). On multi-divisional contracts, separate divisions may be awarded to separate Bidders. The City may also utilize alternatives offered in the Bid Forms, if any, to determine the lowest responsible Bidder on each division, and award multiple divisions to a single Bidder, so that the lowest total cost is achieved for the City. For unit price bids, the Contract will be awarded based upon the unit prices and the lump sum prices stated by the bidder for the work items specified in the bid documents, with

consideration given to any alternates selected by the City. If the City determines that the unit price for any item is materially different for the work item bid than either other bidders or the general market, the City, in its sole discretion, in addition to any other right it may have, may reject the bid as not responsible or non-conforming.

The acceptability of major subcontractors will be considered in determining if a Bidder is responsible. In comparing Bids, the City will give consideration to alternate Bids for items listed in the bid forms. All key staff and subcontractors are subject to the approval by the City.

Official Documents

The City of Ann Arbor officially distributes bid documents from the Procurement Unit or through the Michigan Intergovernmental Trade Network (MITN). Copies of the bid documents obtained from any other source are not Official copies. Addenda and other bid information will only be posted to these official distribution sites. If you obtained City of Ann Arbor Bid documents from other sources, it is recommended that you register on www.MITN.info and obtain an official Bid.

Bid Security

Each bid must be accompanied by a certified check, or Bid Bond by a surety licensed and authorized to do business within the State of Michigan, in the amount of 5% of the total of the bid price.

Withdrawal of Bids

After the time of opening, no Bid may be withdrawn for the period of Ninety (90) days.

Contract Time

Time is of the essence in the performance of the work under this Contract. The available time for work under this Contract is indicated on page C-2, Article III of the Contract. If these time requirements can not be met, the Bidder must stipulate on Bid Form Section 3 - Time Alternate its schedule for performance of the work. Consideration will be given to time in evaluating bids.

Liquidated Damages

A liquidated damages clause, as given on page C-2, Article III of the Contract, provides that the Contractor shall pay the City as liquidated damages, and not as a penalty, a sum certain per day for each and every day that the Contractor may be in default of completion of the specified work, within the time(s) stated in the Contract, or written extensions.

Liquidated damages clauses, as given in the General Conditions, provide further that the City shall be entitled to impose and recover liquidated damages for breach of the obligations under Chapter 112 of the City Code.

The liquidated damages are for the non-quantifiable aspects of any of the previously identified events and do not cover actual damages that can be shown or quantified nor are they intended to preclude recovery of actual damages in addition to the recovery of liquidated damages.

Human Rights Information

All contractors proposing to do business with the City shall satisfy the contract compliance administrative policy adopted by the City Administrator in accordance with the Section 9:158 of the Ann Arbor City Code. Breach of the obligation not to discriminate as outlined in Section 5,

beginning at page GC-3 shall be a material breach of the contract. Contractors are required to post a copy of Ann Arbor's Non-Discrimination Ordinance attached at all work locations where its employees provide services under a contract with the City.

Wage Requirements

Section 4, beginning at page GC-2, outlines the requirements for payment of prevailing wages and for payment of a "living wage" to employees providing service to the City under this contract. The successful bidder and its subcontractors must comply with all applicable requirements and provide documentary proof of compliance when requested.

For laborers whose wage level are subject to federal, state and/or local prevailing wage law the appropriate Davis-Bacon wage rate classification is identified based upon the work including within this contract. **The wage determination(s) current on the date 10 days before bids are due shall apply to this contract.** The U.S. Department of Labor (DOL) has provided explanations to assist with classification in the following resource link: www.wdol.gov.

Conflict Of Interest Disclosure

The City of Ann Arbor Purchasing Policy requires that prospective Vendors complete a Conflict of Interest Disclosure form. A contract may not be awarded to the selected Vendor unless and until the Procurement Unit and the City Administrator have reviewed the Disclosure form and determined that no conflict exists under applicable federal, state, or local law or administrative regulation. Not every relationship or situation disclosed on the Disclosure Form may be a disqualifying conflict. Depending on applicable law and regulations, some contracts may awarded on the recommendation of the City Administrator after full disclosure, where such action is allowed by law, if demonstrated competitive pricing exists and/or it is determined the award is in the best interest of the City. A copy of the Vendor Conflict of Interest Disclosure Form is attached.

Major Subcontractors

The Bidder shall identify on Bid Form Section 4 each major subcontractor it expects to engage for this Contract if the work to be subcontracted is 15% or more of the bid sum or over \$50,000, whichever is less. The Bidder also shall identify the work to be subcontracted to each major subcontractor. The Bidder shall not change or replace a subcontractor without approval by the City.

Debarment

Submission of a Bid in response to this ITB is certification that the Bidder is not currently debarred, suspended, proposed for debarment, and declared ineligible or voluntarily excluded from participation in this transaction by any State or Federal departments or agency. Submission is also agreement that the City will be notified of any changes in this status.

Disclosures

After bids are opened, all information in a submitter's bid is subjected to disclosure under the provisions of Michigan Public Act No. 442 of 1976, as amended (MCL 15.231 et seq.) known as the "Freedom of Information Act." The Freedom of Information Act also provides for the complete disclosure of contracts and attachments thereto except where specifically exempted.

Bid Protest

All Bid protests must be in writing and filed with the Purchasing Agent within five (5) business days of the award action. The bidder must clearly state the reasons for the protest. If a bidder contacts a City Service Area/Unit and indicates a desire to protest an award, the Service Area/Unit shall refer the bidder to the Purchasing Agent. The Purchasing Agent will provide the bidder with the appropriate instructions for filing the protest. The protest shall be reviewed by the City Administrator or designee whose decision shall be final.

Cost Liability

The City of Ann Arbor assumes no responsibility or liability for costs incurred by the Bidder prior to the execution of a contract with the City. By submitting a bid, a bidder agrees to bear all costs incurred or related to the preparation, submission and selection process for the bid.

Reservation of Rights

The City of Ann Arbor reserves the right to accept any bid or alternative bid proposed in whole or in part, to reject any or all bids or alternatives bids in whole or in part and to waive irregularity and/or informalities in any bid and to make the award in any manner deemed in the best interest of the City.

INVITATION TO BID

City of Ann Arbor
Guy C. Larcom Municipal Building
Ann Arbor, Michigan 48107

Ladies and Gentlemen:

The undersigned, as Bidder, declares that this Bid is made in good faith, without fraud or collusion with any person or persons bidding on the same Contract; that this Bidder has carefully read and examined the bid documents, including City Nondiscrimination requirements and Declaration of Compliance Form, Living Wage requirements and Declaration of Compliance Form, Prevailing Wage requirements and Declaration of Compliance Form, Vendor Conflict of Interest Form, Notice of Pre-Bid Conference, Instructions to Bidders, Bid, Bid Forms, Contract, Bond Forms, General Conditions, Standard Specifications, Detailed Specifications, all Addenda, and the Plans (if applicable) and understands them. The Bidder declares that it conducted a full investigation at the site and of the work proposed and is fully informed as to the nature of the work and the conditions relating to the work's performance. The Bidder also declares that it has extensive experience in successfully completing projects similar to this one.

The Bidder acknowledges that it has not received or relied upon any representations or warrants of any nature whatsoever from the City of Ann Arbor, its agents or employees, and that this Bid is based solely upon the Bidder's own independent business judgment.

The undersigned proposes to perform all work shown on the plans or described in the bid documents, including any addenda issued, and to furnish all necessary machinery, tools, apparatus, and other means of construction to do all the work, furnish all the materials, and complete the work in strict accordance with all terms of the Contract of which this Bid is one part.

In accordance with these bid documents, and Addenda numbered _____, the undersigned, as Bidder, proposes to perform at the sites in and/or around Ann Arbor, Michigan, all the work included herein for the amounts set forth in the Bid Forms.

The Bidder declares that it has become fully familiar with the liquidated damage clauses for completion times and for compliance with City Code Chapter 112, understands and agrees that the liquidated damages are for the non-quantifiable aspects of non-compliance and do not cover actual damages that may be shown and agrees that if awarded the Contract, all liquidated damage clauses form part of the Contract.

The Bidder declares that it has become fully familiar with the provisions of Chapter 14, Section 1:320 (Prevailing wages) and Chapter 23 (Living Wage) of the Code of the City of Ann Arbor and that it understands and agrees to comply, to the extent applicable to employees providing services to the City under this Contract, with the wage and reporting requirements stated in the City Code provisions cited. Bidder certifies that the statements contained in the City Prevailing Wage and Living Wage Declaration of Compliance Forms are true and correct. Bidder further agrees that the cited provisions of Chapter 14 and Chapter 23 form a part of this Contract.

The Bidder declares that it has become familiar with the City Conflict of Interest Disclosure Form and certifies that the statement contained therein is true and correct.

The Bidder encloses a certified check or Bid Bond in the amount of 5% of the total of the Bid Price. The Bidder agrees both to contract for the work and to furnish the necessary Bonds and insurance documentation within 10 days after being notified of the acceptance of the Bid.

If this Bid is accepted by the City and the Bidder fails to contract and furnish the required Bonds and insurance documentation within 10 days after being notified of the acceptance of this Bid, then the Bidder shall be considered to have abandoned the Contract and the certified check or Bid Bond accompanying this Bid shall become due and payable to the City.

If the Bidder enters into the Contract in accordance with this Bid, or if this Bid is rejected, then the accompanying check or Bid Bond shall be returned to the Bidder.

In submitting this Bid, it is understood that the right is reserved by the City to accept any Bid, to reject any or all Bids, to waive irregularities and/or informalities in any Bid, and to make the award in any manner the City believes to be in its best interest.

SIGNED THIS _____ DAY OF _____, 201_.

Bidder's Name

Authorized Signature of Bidder

Official Address

(Print Name of Signer Above)

Telephone Number

Email Address for Award Notice

LEGAL STATUS OF BIDDER

(The Bidder shall fill out the appropriate form and strike out the other three.)

Bidder declares that it is:

* A corporation organized and doing business under the laws of the State of _____, for whom _____, bearing the office title of _____, whose signature is affixed to this Bid, is authorized to execute contracts.

NOTE: If not incorporated in Michigan, please attach the corporation's Certificate of Authority

• A limited liability company doing business under the laws of the State of _____, whom _____ bearing the title of _____ whose signature is affixed to this proposal, is authorized to execute contract on behalf of the LLC.

* A partnership, organized under the laws of the state of _____ and filed in the county of _____, whose members are (list all members and the street and mailing address of each) (attach separate sheet if necessary):

* An individual, whose signature with address, is affixed to this Bid: _____
(initial here)

Authorized Official

_____ **Date** _____, 201_

(Print) Name _____ Title _____

Company: _____

Address: _____

Contact Phone () _____ Fax () _____

Email _____

BID FORM

Section 1 - Schedule of Prices

Street Resurfacing - 2016
 File No. 2016-004
 Bid No. 4422

<u>Item No.</u>	<u>Item Description</u>	<u>Unit</u>	<u>Estimated Quantity</u>	<u>Unit Price</u>	<u>Total Price</u>
1047051	General Conditions, Max \$75,000.00	LSUM	1.000	\$ _____	\$ _____
1047051	Project Supervision, Max \$100,000.00	LSUM	1.000	\$ _____	\$ _____
2030011	Dr Structure, Rem	Ea	70.000	\$ _____	\$ _____
2030015	Sewer, Rem, Less than 24 inch	Ft	700.000	\$ _____	\$ _____
2047001	Curb, Gutter, and Curb and Gutter, Any Type, Rem	Ft	15006.000	\$ _____	\$ _____
2047001	Exploratory Excavation (0-10' Deep) Tr Det I	Ea	6.000	\$ _____	\$ _____
2047011	Sidewalk, Sidewalk Ramp, and Driveway Approach, Any Thickness, Rem	Syd	1838.000	\$ _____	\$ _____
2050023	Granular Material, CI II	Cyd	50.000	\$ _____	\$ _____
2057011	Grading, Driveway Approach	Syd	827.000	\$ _____	\$ _____
2057011	Grading, Sidewalk	Syd	640.000	\$ _____	\$ _____
2057011	Grading, Sidewalk Ramp	Syd	672.000	\$ _____	\$ _____
2057011	Machine Grading, Special	Syd	37342.000	\$ _____	\$ _____
2057021	Subgrade Undercutting, Type IIA	Cyd	16666.000	\$ _____	\$ _____
2057021	Subgrade Undercutting, Type IIB	Cyd	1500.000	\$ _____	\$ _____
2080036	Erosion Control, Silt Fence	Ft	2500.000	\$ _____	\$ _____
2087050	Erosion Control, Inlet Filter	Ea	228.000	\$ _____	\$ _____
2090001	Project Cleanup	LSUM	1.000	\$ _____	\$ _____
3010002	Subbase, CIP	Cyd	50.000	\$ _____	\$ _____
3020001	Aggregate Base	Ton	1250.000	\$ _____	\$ _____
TOTAL THIS PAGE					\$ _____

BID FORM

Section 1 - Schedule of Prices

<u>Item No.</u>	<u>Item Description</u>	<u>Unit</u>	<u>Estimated Quantity</u>	<u>Unit Price</u>	<u>Total Price</u>
3020050	Aggregate Base, Conditioning	Syd	3500.000	\$ _____	\$ _____
3060020	Maintenance Gravel	Ton	350.000	\$ _____	\$ _____
3070001	Approach, CI I	Ton	250.000	\$ _____	\$ _____
3070101	Shoulder, CI I	Ton	150.000	\$ _____	\$ _____
3080010	Geotextile, Stabilization	Syd	100.000	\$ _____	\$ _____
3087011	Geogrid, Biaxial, High Performance	Syd	250.000	\$ _____	\$ _____
4020987	Sewer, CI IV, 12 inch, Tr Det B	Ft	700.000	\$ _____	\$ _____
4021260	Trench Undercut and Backfill	Cyd	10.000	\$ _____	\$ _____
4030010	Dr Structure Cover, Type B	Ea	105.000	\$ _____	\$ _____
4030025	Dr Structure Cover, Type D	Ea	4.000	\$ _____	\$ _____
4030050	Dr Structure Cover, Type K	Ea	110.000	\$ _____	\$ _____
4030200	Dr Structure, 24 inch dia	Ea	60.000	\$ _____	\$ _____
4030306	Dr Structure, Tap, 6 inch	Ea	5.000	\$ _____	\$ _____
4037001	Dr Structure Cover, Type B, Special	Ea	9.000	\$ _____	\$ _____
4037001	Dr Structure, Adj, Add Depth, Modified	Ft	5.000	\$ _____	\$ _____
4037050	Dr Structure, Adj, Case 1, Modified	Ea	277.000	\$ _____	\$ _____
4037050	Dr Structure, Adj, Case 2, Modified	Ea	5.000	\$ _____	\$ _____
4037050	Dr Structure, Cleaning, Modified	Ea	25.000	\$ _____	\$ _____
4037050	Dr Structure, Double Inlet	Ea	10.000	\$ _____	\$ _____
4037050	Dr Structure, Point	Ea	8.000	\$ _____	\$ _____
TOTAL THIS PAGE					\$ _____

BID FORM

Section 1 - Schedule of Prices

<u>Item No.</u>	<u>Item Description</u>	<u>Unit</u>	<u>Estimated Quantity</u>	<u>Unit Price</u>	<u>Total Price</u>
4037050	Dr Structure, Reconstruct	Ea	1.000	\$ _____	\$ _____
4037050	Dr Structure, Temp Lowering, Modified	Ea	237.000	\$ _____	\$ _____
4047001	Underdrain, Subgrade, 6 inch, Special	Ft	3000.000	\$ _____	\$ _____
5010001	Pavt, Cleaning	LSUM	1.000	\$ _____	\$ _____
5010003	Cold Milling HMA Surface	Ton	21157.000	\$ _____	\$ _____
5010005	HMA Surface, Rem	Syd	2521.000	\$ _____	\$ _____
5010015	Joint and Crack, Cleanout	Ft	2500.000	\$ _____	\$ _____
5010025	Hand Patching	Ton	172.500	\$ _____	\$ _____
5010051	HMA, 4E3	Ton	2628.000	\$ _____	\$ _____
5010057	HMA, 5E3	Ton	9550.000	\$ _____	\$ _____
5010061	HMA, Approach	Ton	591.000	\$ _____	\$ _____
5010703	HMA, LVSP	Ton	8388.000	\$ _____	\$ _____
5017001	HMA, Curb	Ft	250.000	\$ _____	\$ _____
5017001	HMA, Raised Crosswalk	Syd	60.000	\$ _____	\$ _____
5017001	HMA, Raised Intersection	Syd	175.000	\$ _____	\$ _____
5017001	HMA, Speed Hump	Syd	35.000	\$ _____	\$ _____
5017031	Cold Milling HMA Surface, Curb Reveal	Ton	96.750	\$ _____	\$ _____
5017031	HMA, Wedging, 36A	Ton	8.000	\$ _____	\$ _____
6027021	Flowable Fill	Cyd	556.333	\$ _____	\$ _____
6030005	Cement	Ton	60.000	\$ _____	\$ _____
TOTAL THIS PAGE					\$ _____

BID FORM

Section 1 - Schedule of Prices

<u>Item No.</u>	<u>Item Description</u>	<u>Unit</u>	<u>Estimated Quantity</u>	<u>Unit Price</u>	<u>Total Price</u>
8017011	Driveway, Nonreinf Conc, 6 inch, Modified	Syd	779.000	\$ _____	\$ _____
8017011	Driveway, Nonreinf Conc, 8 inch, Modified	Syd	48.000	\$ _____	\$ _____
8027001	Curb and Gutter, Conc	Ft	11221.000	\$ _____	\$ _____
8027001	Driveway Opening, Conc, Det M, Modified	Ft	3432.000	\$ _____	\$ _____
8037001	Detectable Warning Surface, Modified	Ft	380.000	\$ _____	\$ _____
8037001	Fence, Protective, Modified	Ft	250.000	\$ _____	\$ _____
8037010	Sidewalk Ramp, Conc, 6 inch, Modified	Sft	6014.000	\$ _____	\$ _____
8037010	Sidewalk Retaining Wall, Integral, 6 inch to 18 inch Height	Sft	65.000	\$ _____	\$ _____
8037010	Sidewalk Retaining Wall, Integral, Less than 6 inch Height	Sft	15.000	\$ _____	\$ _____
8037010	Sidewalk, Conc or Clay Brick Pavers, Rem	Sft	25.000	\$ _____	\$ _____
8037010	Sidewalk, Conc, 4 inch, Modified	Sft	4875.000	\$ _____	\$ _____
8037010	Sidewalk, Conc, 6 inch, Modified	Sft	824.900	\$ _____	\$ _____
8110049	Pavt Mrkg, Ovly Cold Plastic, Direction Arrow Sym, Bike	Ea	41.000	\$ _____	\$ _____
8110058	Pavt Mrkg, Ovly Cold Plastic, Bike, Small Sym	Ea	41.000	\$ _____	\$ _____
8110079	Pavt Mrkg, Ovly Cold Plastic, Sharrow Symbol	Ea	1.000	\$ _____	\$ _____
8110153	Pavt Mrkg, Sprayable Thermopl, 4 inch, White	Ft	4033.000	\$ _____	\$ _____
8110154	Pavt Mrkg, Sprayable Thermopl, 4 inch, Yellow	Ft	55991.000	\$ _____	\$ _____
8110155	Pavt Mrkg, Sprayable Thermopl, 6 inch, White	Ft	42267.000	\$ _____	\$ _____
8110197	Pavt Mrkg, Thermopl, 6 inch, Crosswalk	Ft	2430.000	\$ _____	\$ _____
8110212	Pavt Mrkg, Thermopl, 12 inch, Cross Hatching, White	Ft	225.000	\$ _____	\$ _____
TOTAL THIS PAGE					\$ _____

BID FORM

Section 1 - Schedule of Prices

<u>Item No.</u>	<u>Item Description</u>	<u>Unit</u>	<u>Estimated Quantity</u>	<u>Unit Price</u>	<u>Total Price</u>
8110213	Pavt Mrkg, Thermopl, 12 inch, Cross Hatching, Yellow	Ft	36.000	\$ _____	\$ _____
8110218	Pavt Mrkg, Thermopl, 24 inch, Stop Bar	Ft	984.000	\$ _____	\$ _____
8110332	Rem Raised Pavt Marker	Ea	25.000	\$ _____	\$ _____
8110343	Rem Spec Mrkg	Sft	250.000	\$ _____	\$ _____
8110450	Recessing Pavement Markings, Longit	Ft	10000.000	\$ _____	\$ _____
8110451	Recessing Pavement Markings, Transv	Sft	500.000	\$ _____	\$ _____
8117001	Pavt Mrkg, Thermopl, 24 inch, Crosswalk	Ft	1368.000	\$ _____	\$ _____
8117050	Pavt Mrkg, Thermopl, Lt Turn Arrow Sym	Ea	11.000	\$ _____	\$ _____
8117050	Pavt Mrkg, Thermopl, Only	Ea	14.000	\$ _____	\$ _____
8117050	Pavt Mrkg, Thermopl, Railroad Sym	Ea	2.000	\$ _____	\$ _____
8117050	Pavt Mrkg, Thermopl, Rt Turn Arrow Sym	Ea	5.000	\$ _____	\$ _____
8117050	Pavt Mrkg, Thermopl, School	Ea	3.000	\$ _____	\$ _____
8117050	Pavt Mrkg, Thermopl, Speed Hump Chevron, White	Ea	1.000	\$ _____	\$ _____
8120012	Barricade, Type III, High Intensity, Double Sided, Lighted, Furn	Ea	96.000	\$ _____	\$ _____
8120013	Barricade, Type III, High Intensity, Double Sided, Lighted, Oper	Ea	96.000	\$ _____	\$ _____
8120030	Channelizing Device, 42 inch, Furn	Ea	500.000	\$ _____	\$ _____
8120031	Channelizing Device, 42 inch, Oper	Ea	500.000	\$ _____	\$ _____
8120140	Lighted Arrow, Type C, Furn	Ea	12.000	\$ _____	\$ _____
8120141	Lighted Arrow, Type C, Oper	Ea	12.000	\$ _____	\$ _____
8120210	Pavt Mrkg, Longit, 6 inch or Less Width, Rem	Ft	250.000	\$ _____	\$ _____
TOTAL THIS PAGE					\$ _____

BID FORM

Section 1 - Schedule of Prices

<u>Item No.</u>	<u>Item Description</u>	<u>Unit</u>	<u>Estimated Quantity</u>	<u>Unit Price</u>	<u>Total Price</u>
8120220	Pavt Mrkg, Type NR, Paint, 4 inch, White, Temp	Ft	20000.000	\$ _____	\$ _____
8120221	Pavt Mrkg, Type NR, Paint, 4 inch, Yellow, Temp	Ft	2800.000	\$ _____	\$ _____
8120240	Pavt Mrkg, Type R, 4 inch, White, Temp	Ft	1500.000	\$ _____	\$ _____
8120241	Pavt Mrkg, Type R, 4 inch, Yellow, Temp	Ft	2000.000	\$ _____	\$ _____
8120260	Plastic Drum, High Intensity, Lighted, Furn	Ea	1527.000	\$ _____	\$ _____
8120261	Plastic Drum, High Intensity, Lighted, Oper	Ea	1527.000	\$ _____	\$ _____
8120330	Sign, Portable, Changeable Message, Furn	Ea	21.000	\$ _____	\$ _____
8120331	Sign, Portable, Changeable Message, Oper	Ea	21.000	\$ _____	\$ _____
8120350	Sign, Type B, Temp, Prismatic, Furn	Sft	5611.000	\$ _____	\$ _____
8120351	Sign, Type B, Temp, Prismatic, Oper	Sft	5611.000	\$ _____	\$ _____
8120370	Traf Regulator Control	LSUM	1.000	\$ _____	\$ _____
8127050	No Parking Sign	Ea	544.000	\$ _____	\$ _____
8127051	Minor Traf Devices, Max \$60,000.00	LSUM	1.000	\$ _____	\$ _____
8157060	Irrigation System, Protection and Maintenance	Dir	2500.000	\$ _____	\$ _____
8167011	Slope Restoration	Syd	5511.000	\$ _____	\$ _____
8190159	Conduit, Schedule 80, 3 inch	Ft	100.000	\$ _____	\$ _____
8197050	Handhole Assembly, 12 Inch X 18 Inch	Ea	2.000	\$ _____	\$ _____
8197050	Handhole Assembly, 17 Inch X 30 Inch	Ea	1.000	\$ _____	\$ _____
8217050	Monument Box Adjust	Ea	5.000	\$ _____	\$ _____
8230421	Water Shutoff, Adj, Case 1	Ea	1.000	\$ _____	\$ _____
TOTAL THIS PAGE					\$ _____

BID FORM

Section 1 - Schedule of Prices

<u>Item No.</u>	<u>Item Description</u>	<u>Unit</u>	<u>Estimated Quantity</u>	<u>Unit Price</u>	<u>Total Price</u>
8230422	Water Shutoff, Adj, Case 2	Ea	1.000	\$ _____	\$ _____
8230431	Gate Box, Adj, Case 1	Ea	33.000	\$ _____	\$ _____
8230432	Gate Box, Adj, Case 2	Ea	1.000	\$ _____	\$ _____
8507050	Sewer, SDR 26 PVC, Riser, 6 inch	Ft	10.000	\$ _____	\$ _____
8507050	Sewer, SDR 26 PVC, 45 deg Bend, 6 inch	Ft	1.000	\$ _____	\$ _____
8507050	Sewer, SDR 26 PVC, Service Lead, 6 inch, Tr Det I Modified	Ft	15.000	\$ _____	\$ _____
8507050	Sewer, SDR 26 PVC, Tee or Wye, 8 inch by 6 inch	Ea	1.000	\$ _____	\$ _____
TOTAL THIS PAGE					\$ _____
TOTAL FROM PAGE BF-1					\$ _____
TOTAL FROM PAGE BF-2					\$ _____
TOTAL FROM PAGE BF-3					\$ _____
TOTAL FROM PAGE BF-4					\$ _____
TOTAL FROM PAGE BF-5					\$ _____
TOTAL FROM PAGE BF-6					\$ _____
TOTAL BASE BID					\$ _____

BID FORM

Section 2 - Material and Equipment Alternates

The Base Bid proposal price shall include materials and equipment selected from the designated items and manufacturers listed in the bidding documents. This is done to establish uniformity in bidding and to establish standards of quality for the items named.

If the Contractor wishes to quote alternate items for consideration by the City, it may do so under this Section. A complete description of the item and the proposed price differential must be provided. Unless approved at the time of award, substitutions where items are specifically named will be considered only as a negotiated change in Contract Sum.

<u>Item Number</u>	<u>Description</u>	<u>Add/Deduct Amount</u>
--------------------	--------------------	--------------------------

If the Bidder does not suggest any material or equipment alternate, the Bidder **MUST** complete the following statement:

For the work outlined in this request for bid, the bidder does NOT propose any material or equipment alternate under the Contract.

Signature of Authorized Representative of Bidder _____ Date _____

BID FORM

Section 3 - Time Alternate

If the Bidder takes exception to the time stipulated in Article III of the Contract, Time of Completion, page C-2, it is requested to stipulate below its proposed time for performance of the work. Consideration will be given to time in evaluating bids.

If the Bidder does not suggest any time alternate, the Bidder **MUST** complete the following statement:

For the work outlined in this request for bid, the bidder does NOT propose any time alternate under the Contract.

Signature of Authorized Representative of Bidder _____ Date _____

BID FORM

Section 4 - Major Subcontractors

For purposes of this Contract, a Subcontractor is anyone (other than the Contractor) who performs work (other than or in addition to the furnishing of materials, plans or equipment) at or about the construction site, directly or indirectly for or on behalf of the Contractor (and whether or not in privity of Contract with the Contractor), but shall not include any individual who furnishes merely the individual's own personal labor or services.

For the work outlined in these documents the Bidder expects to engage the following major subcontractors to perform the work identified:

<u>Subcontractor (Name and Address)</u>	<u>Work</u>	<u>Amount</u>
---	-------------	---------------

If the Bidder does not expect to engage any major subcontractor, the Bidder **MUST** complete the following statement:

For the work outlined in this request for bid, the bidder does NOT expect to engage any major subcontractor to perform work under the Contract.

Signature of Authorized Representative of Bidder _____ Date _____

SAMPLE STANDARD CONTRACT

If a contract is awarded, the selected contractor will be required to adhere to a set of general contract provisions which will become a part of any formal agreement. These provisions are general principles which apply to all contractors of service to the City of Ann Arbor such as the following:

CONTRACT

THIS AGREEMENT is made on the _____ day of _____, 20____, between the CITY OF ANN ARBOR, a Michigan Municipal Corporation, 301 East Huron Street, Ann Arbor, Michigan 48104 ("City") and _____ ("Contractor")

(An individual/partnership/corporation, include state of incorporation)

(Address)

Based upon the mutual promises below, the Contractor and the City agree as follows:

ARTICLE I - Scope of Work

The Contractor agrees to furnish all of the materials, equipment and labor necessary; and to abide by all the duties and responsibilities applicable to it for the project titled "Council Chamber Renovations Phase 2" in accordance with the requirements and provisions of the following documents, including all written modifications incorporated into any of the documents, which are incorporated as part of this Contract:

Non-discrimination and Living Wage
Declaration of Compliance Forms (if
applicable)
Vendor Conflict of Interest Form
Prevailing Wage Declaration of
Compliance Form (if applicable)
Bid Forms
Contract and Exhibits
Bonds

General Conditions
Standard Specifications
Detailed Specifications
Plans
Addenda

ARTICLE II - Definitions

Administering Service Area/Unit means **[Insert Name of Administering Service Unit]**

Project means **[Insert Title of Bid and Bid Number]**

ARTICLE III - Time of Completion

- (A) The work to be completed under this Contract shall begin immediately on the date specified in the Notice to Proceed issued by the City.
- (B) The entire work for this Contract shall be completed within _____ () consecutive calendar days.
- (C) Failure to complete all the work within the time specified above, including any extension granted in writing by the Supervising Professional, shall obligate the Contractor to pay the City, as liquidated damages and not as a penalty, an amount equal to \$_____ for each calendar day of delay in the completion of all the work. If any liquidated damages are unpaid by the Contractor, the City shall be entitled to deduct these unpaid liquidated damages from the monies due the Contractor.

The liquidated damages are for the non-quantifiable aspects of any of the previously identified events and do not cover actual damages that can be shown or quantified nor are they intended to preclude recovery of actual damages in addition to the recovery of liquidated damages.

ARTICLE IV - The Contract Sum

Choose one only.

- (A) The City shall pay to the Contractor for the performance of the Contract, the lump sum price as given in the Bid Form in the amount of:

_____ Dollars (\$_____)

Or

- (A) The City shall pay to the Contractor for the performance of the Contract, the unit prices as given in the Bid Form for the estimated bid total of:

_____ Dollars (\$_____)

- (B) The amount paid shall be equitably adjusted to cover changes in the work ordered by the Supervising Professional but not required by the Contract Documents. Increases or decreases shall be determined only by written agreement between the City and Contractor.

ARTICLE V - Assignment

This Contract may not be assigned or subcontracted without the written consent of the City.

ARTICLE VI - Choice of Law

This Contract shall be construed, governed, and enforced in accordance with the laws of the State of Michigan. By executing this agreement, the Contractor and the City agree to venue in a court of appropriate jurisdiction sitting within Washtenaw County for purposes of any action arising under this Contract. The parties stipulate that the venue referenced in this Contract is for convenience and waive any claim of non-convenience.

Whenever possible, each provision of the Contract will be interpreted in a manner as to be effective and valid under applicable law. The prohibition or invalidity, under applicable law, of any provision will not invalidate the remainder of the Contract.

ARTICLE VII - Relationship of the Parties

The parties of the Contract agree that it is not a Contract of employment but is a Contract to accomplish a specific result. Contractor is an independent Contractor performing services for the City. Nothing contained in this Contract shall be deemed to constitute any other relationship between the City and the Contractor.

Contractor certifies that it has no personal or financial interest in the project other than the compensation it is to receive under the Contract. Contractor certifies that it is not, and shall not

become, overdue or in default to the City for any Contract, debt, or any other obligation to the City including real or personal property taxes. City shall have the right to set off any such debt against compensation awarded for services under this agreement.

ARTICLE VIII - Notice

All notices given under this Contract shall be in writing, and shall be by personal delivery or by certified mail with return receipt requested to the parties at their respective addresses as specified in the Contract Documents or other address the Contractor may specify in writing.

ARTICLE IX - Indemnification

To the fullest extent permitted by law, Contractor shall indemnify, defend and hold harmless the City, its officers, employees and agents harmless from all suits, claims, judgments and expenses including attorney's fees resulting or alleged to result, in whole or in part, from any act or omission, which is in any way connected or associated with this Contract, by the Contractor or anyone acting on the Contractor's behalf under this Contract. Contractor shall not be responsible to indemnify the City for losses or damages caused by or resulting from the City's sole negligence.

ARTICLE X - Entire Agreement

This Contract represents the entire understanding between the City and the Contractor and it supersedes all prior representations or agreements whether written or oral. Neither party has relied on any prior representations in entering into this Contract. This Contract may be altered, amended or modified only by written amendment signed by the City and the Contractor.

FOR CONTRACTOR

By _____

Its: _____

FOR THE CITY OF ANN ARBOR

By _____
Christopher Taylor, Mayor

By _____
Jacqueline Beaudry, City Clerk

Approved as to substance

By _____
City Administrator

By _____
Services Area Administrator

Approved as to form and content

Stephen K. Postema, City Attorney

PERFORMANCE BOND

- (1) _____(referred to as "Principal"), and _____, a corporation duly authorized to do business in the State of Michigan (referred to as "Surety"), are bound to the City of Ann Arbor, Michigan (referred to as "City"), for \$ _____, the payment of which Principal and Surety bind themselves, their heirs, executors, administrators, successors and assigns, jointly and severally, by this bond.
- (2) The Principal has entered a written Contract with the City dated _____, 201_, for: _____ and this bond is given for that Contract in compliance with Act No. 213 of the Michigan Public Acts of 1963, as amended, being MCL 129.201 et seq.
- (3) Whenever the Principal is declared by the City to be in default under the Contract, the Surety may promptly remedy the default or shall promptly:
- (a) complete the Contract in accordance with its terms and conditions; or
 - (b) obtain a bid or bids for submission to the City for completing the Contract in accordance with its terms and conditions, and upon determination by Surety of the lowest responsible bidder, arrange for a Contract between such bidder and the City, and make available, as work progresses, sufficient funds to pay the cost of completion less the balance of the Contract price; but not exceeding, including other costs and damages for which Surety may be liable hereunder, the amount set forth in paragraph 1.
- (4) Surety shall have no obligation to the City if the Principal fully and promptly performs under the Contract.
- (5) Surety agrees that no change, extension of time, alteration or addition to the terms of the Contract or to the work to be performed thereunder, or the specifications accompanying it shall in any way affect its obligations on this bond, and waives notice of any such change, extension of time, alteration or addition to the terms of the Contract or to the work, or to the specifications.

SIGNED AND SEALED this _____ day of _____, 201_.

(Name of Surety Company)

By _____
(Signature)

Its _____
(Title of Office)

Approved as to form:

Stephen K. Postema, City Attorney

(Name of Principal)

By _____
(Signature)

Its _____
(Title of Office)

Name and address of agent:

LABOR AND MATERIAL BOND

- (1) _____
of _____(referred to
as "Principal"), and _____, a corporation
duly authorized to do business in the State of Michigan, (referred to as "Surety"), are bound
to the City of Ann Arbor, Michigan (referred to as "City"), for the use and benefit of claimants
as defined in Act 213 of Michigan Public Acts of 1963, as amended, being MCL 129.201 et
seq., in the amount of
\$ _____, for the payment of which Principal and Surety bind themselves,
their heirs, executors, administrators, successors and assigns, jointly and severally, by this
bond.
- (2) The Principal has entered a written Contract with the City, dated _____, 201_,
for _____
_____ ; and this bond
is given for that Contract in compliance with Act No. 213 of the Michigan Public Acts of 1963
as amended;
- (3) If the Principal fails to promptly and fully repay claimants for labor and material reasonably
required under the Contract, the Surety shall pay those claimants.
- (4) Surety's obligations shall not exceed the amount stated in paragraph 1, and Surety shall
have no obligation if the Principal promptly and fully pays the claimants.

SIGNED AND SEALED this _____ day of _____, 201_

(Name of Surety Company)
By _____
(Signature)
Its _____
(Title of Office)

(Name of Principal)
By _____
(Signature)
Its _____
(Title of Office)

Approved as to form:

Name and address of agent:

Stephen K. Postema, City Attorney

GENERAL CONDITIONS

Section 1 - Execution, Correlation and Intent of Documents

The contract documents shall be signed in 2 copies by the City and the Contractor.

The contract documents are complementary and what is called for by any one shall be binding. The intention of the documents is to include all labor and materials, equipment and transportation necessary for the proper execution of the work. Materials or work described in words which so applied have a well-known technical or trade meaning have the meaning of those recognized standards.

In case of a conflict among the contract documents listed below in any requirement(s), the requirement(s) of the document listed first shall prevail over any conflicting requirement(s) of a document listed later.

(1) Addenda in reverse chronological order; (2) Detailed Specifications; (3) Standard Specifications; (4) Plans; (5) General Conditions; (6) Contract; (7) Bid Forms; (8) Bond Forms; (9) Bid.

Section 2 - Order of Completion

The Contractor shall submit with each invoice, and at other times reasonably requested by the Supervising Professional, schedules showing the order in which the Contractor proposes to carry on the work. They shall include the dates at which the Contractor will start the several parts of the work, the estimated dates of completion of the several parts, and important milestones within the several parts.

Section 3 - Familiarity with Work

The Bidder or its representative shall make personal investigations of the site of the work and of existing structures and shall determine to its own satisfaction the conditions to be encountered, the nature of the ground, the difficulties involved, and all other factors affecting the work proposed under this Contract. The Bidder to whom this Contract is awarded will not be entitled to any additional compensation unless conditions are clearly different from those which could reasonably have been anticipated by a person making diligent and thorough investigation of the site.

The Bidder shall immediately notify the City upon discovery, and in every case prior to submitting its Bid, of every error or omission in the bidding documents that would be identified by a reasonably competent, diligent Bidder. In no case will a Bidder be allowed the benefit of extra compensation or time to complete the work under this Contract for extra expenses or time spent as a result of the error or omission.

Section 4 - Wage Requirements

Under this Contract, the Contractor shall conform to Chapter 14 of Title I of the Code of the City of Ann Arbor as amended; which in part states "...that all craftsmen, mechanics and laborers employed directly on the site in connection with said improvements, including said employees of subcontractors, shall receive the prevailing wage for the corresponding classes of craftsmen,

mechanics and laborers, as determined by statistics for the Ann Arbor area compiled by the United States Department of Labor. At the request of the City, any contractor or subcontractor shall provide satisfactory proof of compliance with the contract provisions required by the Section."

Where the Contract and the Ann Arbor City Ordinance are silent as to definitions of terms required in determining contract compliance with regard to prevailing wages, the definitions provided in the Davis-Bacon Act as amended (40 U.S.C. 278-a to 276-a-7) for the terms shall be used.

Further, to the extent that any employees of the Contractor providing services under this contract are not part of the class of craftsmen, mechanics and laborers who receive a prevailing wage in conformance with Section 1:320 of Chapter 14 of Title I of the Code of the City of Ann Arbor, the Contractor agrees to conform to Chapter 23 of Title I of the Code of the City of Ann Arbor, as amended, which in part states:

1:814. Applicability.

- (1) This Chapter shall apply to any person that is a contractor/bidder or grantee as defined in Section 1:813 that employs or contracts with five (5) or more individuals; provided, however, that this Chapter shall not apply to a non-profit contractor/bidder or non-profit grantee unless it employs or contracts with ten (10) or more individuals.
- (2) This Chapter shall apply to any grant, contract, or subcontract or other form of financial assistance awarded to or entered into with a contractor/bidder or grantee after the effective date of this Chapter and to the extension or renewal after the effective date of this Chapter of any grant, contract, or subcontract or other form of financial assistance with a contractor/bidder or grantee.

1:815. Living Wages Required.

- (1) Every contractor/bidder or grantee, as defined in Section 1:813, shall pay its covered employees a living wage as established in this Section.
 - (a) For a covered employer that provides employee health care to its employees, the living wage shall be \$12.52 an hour, or the adjusted amount hereafter established under Section 1:815(3).
 - (b) For a covered employer that does not provide health care to its employees, the living wage shall be \$13.96 an hour, or the adjusted amount hereafter established under Section 1:815(3).
- (2) In order to qualify to pay the living wage rate for covered employers providing employee health care under subsection 1:815(1)(a), a covered employer shall furnish proof of said health care coverage and payment therefor to the City Administrator or his/her designee.
- (3) The amount of the living wage established in this Section shall be adjusted upward no later than April 30, 2002, and every year thereafter by a percentage equal to the percentage increase, if any, in the federal poverty guidelines as published by the United States Department of Health and Human Services for the years 2001 and 2002. Subsequent annual adjustments shall be based upon the percentage increase, if any, in the United States Department of Health and Human Services poverty guidelines when comparing the prior calendar year's poverty guidelines to the present calendar year's guidelines. The applicable percentage amount will be converted to an amount in cents by multiplying the existing wage under Section 1.815(1)(b) by said percentage, rounding upward to the next cent, and adding this amount of cents to the existing living wage

levels established under Sections 1:815(1)(a) and 1:815(1)(b). Prior to April 1 of each calendar year, the City will notify any covered employer of this adjustment by posting a written notice in a prominent place in City Hall, and, in the case of a covered employer that has provided an address of record to the City, by a written letter to each such covered employer.

Contractor agrees that all subcontracts entered into by the Contractor shall contain similar wage provision covering subcontractor's employees who perform work on this contract.

Section 5 - Non-Discrimination

The Contractor agrees to comply, and to require its subcontractor(s) to comply, with the nondiscrimination provisions of Section 209 of the Elliot-Larsen Civil Rights Act (MCL 37.2209). The Contractor further agrees to comply with the nondiscrimination provisions of Chapter 112 of the Ann Arbor City Code and to assure that applicants are employed and that employees are treated during employment in a manner which provides equal employment opportunity. The Contractor further agrees to comply with the provisions of Section 9:158 of Chapter 112 of the Ann Arbor City Code and in particular the following excerpts:

9:158. - Nondiscrimination by city contractors.

- (1) All contractors proposing to do business with the City of Ann Arbor shall satisfy the contract compliance administrative policy adopted by the City Administrator in accordance with the guidelines of this section. All city contractors shall ensure that applicants are employed and that employees are treated during employment in a manner which provides equal employment opportunity and tends to eliminate inequality based upon any classification protected by this chapter. All contractors shall agree not to discriminate against an employee or applicant for employment with respect to hire, tenure, terms, conditions, or privileges of employment, or a matter directly or indirectly related to employment, because of any applicable protected classification.
- (2) All contractors shall be required to post a copy of Ann Arbor's Non-Discrimination Ordinance at all work locations where its employees provide services under a contract with the city.
- (3) Upon request, each prospective contractor shall submit to the city data showing current total employment by occupational category, sex and minority group and shall respond to information requests documenting its equal employment opportunity policies and procedures.
- (4) If the contract which is being awarded includes federal requirements for affirmative action, each prospective contractor shall submit to the city data showing current total employment by occupational category, sex and minority group. If, after verifying this data, the City Administrator's designee concludes that it indicates total minority and female employment commensurate with their availability within the contractor's labor recruitment area, i.e., the area from which the contractor can reasonably be expected to recruit, said contractor shall be accepted by the City Administrator's designee as having fulfilled affirmative action requirements for the period of the contract at which time the City Administrator's designee shall conduct another review. If the data demonstrates an under-representation the contractor shall develop an affirmative action program for review by the City Administrator's designee. Said program shall include specific goals and timetables for the hiring and promotion of minorities and females. Said goals shall reflect the availability of minorities and females within the contractor's labor recruitment area. In the case of construction contractors, the City Administrator's designee shall use for employment verification the labor recruitment area of the Ann Arbor metropolitan statistical area. Construction contractors determined to be in compliance shall be accepted by the City Administrator's designee as having fulfilled affirmative action requirements for a period of 1 year at which time the City Administrator's designee shall conduct another review.

- (5) In hiring for construction projects, contractors shall make good faith efforts to employ local persons, so as to enhance the local economy.
- (6) All contracts shall include provisions through which the contractor agrees to follow all applicable federal and state laws.
- (7) The City Administrator's designee shall monitor the compliance of each contractor with the nondiscrimination provisions of each contract. The City Administrator's designee, together with the Human Rights Commission, shall develop procedures and regulations consistent with the administrative policy adopted by the City Administrator for notice and enforcement of non-compliance. Such procedures and regulations shall include a provision for the posting of contractors not in compliance.
- (8) The City Administrator's designee will provide the City's Human Rights Commission with an annual summary report of contracts awarded; affirmative action requirements reviewed, where applicable; any complaints received alleging violation of the contractor's non-discrimination requirements, and actions taken. The Human Rights Commission will be provided, at its request, with additional information related to the report. The Human Rights Commission and the City Administrator's designee will report annually to the City Council on compliance of city contractors with this chapter.
- (9) All city contracts shall provide further that breach of the obligation not to discriminate shall be a material breach of the contract for which the city shall be entitled, at its option, to do any or all of the following:
 - (a) Cancel, terminate, or suspend the contract in whole or part and/or refuse to make any required periodic payments under the contract;
 - (b) Declare the contractor ineligible for the award of any future contracts with the city for a specified length of time;
 - (c) Recover liquidated damages of a specified sum, said sum to be that percentage of the labor expenditure for the time period involved which would have accrued to protected class members had the discrimination provisions not been breached;
 - (d) Impose for each day of non-compliance, liquidated damages of a specified sum, based upon the following schedule:

Contract Amount	Assessed Damages Per Day of Non-Compliance
\$25,000—99,999	\$50.00
100,000—199,999	100.00
200,000—499,999	150.00
500,000—1,499,999	200.00
1,500,000—2,999,999	250.00
3,000,000—4,999,999	300.00
5,000,000 and above	500.00

- (e) In addition the contractor shall be liable for any costs or expenses incurred by the City of Ann Arbor in obtaining from other sources the work and services to be rendered or performed or the goods or properties to be furnished or delivered to the city under this contract.

(Ord. No. 14-25, § 1, 10-20-14)

Section 6 - Materials, Appliances, Employees

Unless otherwise stipulated, the Contractor shall provide and pay for all materials, labor, water, tools, equipment, light, power, transportation, and other facilities necessary or used for the execution and completion of the work. Unless otherwise specified, all materials incorporated in the permanent work shall be new, and both workmanship and materials shall be of the highest quality. The Contractor shall, if required, furnish satisfactory evidence as to the kind and quality of materials.

The Contractor shall at all times enforce strict discipline and good order among its employees, and shall seek to avoid employing on the work any unfit person or anyone not skilled in the work assigned.

Adequate sanitary facilities shall be provided by the Contractor.

Section 7 - Qualifications for Employment

The Contractor shall employ competent laborers and mechanics for the work under this Contract. For work performed under this Contract, employment preference shall be given to qualified local residents.

Section 8 - Royalties and Patents

The Contractor shall pay all royalties and license fees. It shall defend all suits or claims for infringements of any patent rights and shall hold the City harmless from loss on account of infringement except that the City shall be responsible for all infringement loss when a particular process or the product of a particular manufacturer or manufacturers is specified, unless the City has notified the Contractor prior to the signing of the Contract that the particular process or product is patented or is believed to be patented.

Section 9 - Permits and Regulations

The Contractor must secure and pay for all permits, permit or plan review fees and licenses necessary for the prosecution of the work. These include but are not limited to City building permits, right-of-way permits, lane closure permits, right-of-way occupancy permits, and the like. The City shall secure and pay for easements shown on the plans unless otherwise specified.

The Contractor shall give all notices and comply with all laws, ordinances, rules and regulations bearing on the conduct of the work as drawn and specified. If the Contractor observes that the contract documents are at variance with those requirements, it shall promptly notify the Supervising Professional in writing, and any necessary changes shall be adjusted as provided in the Contract for changes in the work.

Section 10 - Protection of the Public and of Work and Property

The Contractor is responsible for the means, methods, sequences, techniques and procedures of construction and safety programs associated with the work contemplated by this contract. The Contractor, its agents or sub-contractors, shall comply with the "General Rules and Regulations for the Construction Industry" as published by the Construction Safety Commission of the State of Michigan and to all other local, State and National laws, ordinances, rules and regulations pertaining to safety of persons and property.

The Contractor shall take all necessary and reasonable precautions to protect the safety of the public. It shall continuously maintain adequate protection of all work from damage, and shall

take all necessary and reasonable precautions to adequately protect all public and private property from injury or loss arising in connection with this Contract. It shall make good any damage, injury or loss to its work and to public and private property resulting from lack of reasonable protective precautions, except as may be due to errors in the contract documents, or caused by agents or employees of the City. The Contractor shall obtain and maintain sufficient insurance to cover damage to any City property at the site by any cause.

In an emergency affecting the safety of life, or the work, or of adjoining property, the Contractor is, without special instructions or authorization from the Supervising Professional, permitted to act at its discretion to prevent the threatened loss or injury. It shall also so act, without appeal, if authorized or instructed by the Supervising Professional.

Any compensation claimed by the Contractor for emergency work shall be determined by agreement or in accordance with the terms of Claims for Extra Cost - Section 15.

Section 11 - Inspection of Work

The City shall provide sufficient competent personnel for the inspection of the work.

The Supervising Professional shall at all times have access to the work whenever it is in preparation or progress, and the Contractor shall provide proper facilities for access and for inspection.

If the specifications, the Supervising Professional's instructions, laws, ordinances, or any public authority require any work to be specially tested or approved, the Contractor shall give the Supervising Professional timely notice of its readiness for inspection, and if the inspection is by an authority other than the Supervising Professional, of the date fixed for the inspection. Inspections by the Supervising Professional shall be made promptly, and where practicable at the source of supply. If any work should be covered up without approval or consent of the Supervising Professional, it must, if required by the Supervising Professional, be uncovered for examination and properly restored at the Contractor's expense.

Re-examination of any work may be ordered by the Supervising Professional, and, if so ordered, the work must be uncovered by the Contractor. If the work is found to be in accordance with the contract documents, the City shall pay the cost of re-examination and replacement. If the work is not in accordance with the contract documents, the Contractor shall pay the cost.

Section 12 - Superintendence

The Contractor shall keep on the work site, during its progress, a competent superintendent and any necessary assistants, all satisfactory to the Supervising Professional. The superintendent will be responsible to perform all on-site project management for the Contractor. The superintendent shall be experienced in the work required for this Contract. The superintendent shall represent the Contractor and all direction given to the superintendent shall be binding as if given to the Contractor. Important directions shall immediately be confirmed in writing to the Contractor. Other directions will be confirmed on written request. The Contractor shall give efficient superintendence to the work, using its best skill and attention.

Section 13 - Changes in the Work

The City may make changes to the quantities of work within the general scope of the Contract at any time by a written order and without notice to the sureties. If the changes add to or deduct from the extent of the work, the Contract Sum shall be adjusted accordingly. All the changes shall be executed under the conditions of the original Contract except that any claim for

extension of time caused by the change shall be adjusted at the time of ordering the change.

In giving instructions, the Supervising Professional shall have authority to make minor changes in the work not involving extra cost and not inconsistent with the purposes of the work, but otherwise, except in an emergency endangering life or property, no extra work or change shall be made unless in pursuance of a written order by the Supervising Professional, and no claim for an addition to the Contract Sum shall be valid unless the additional work was ordered in writing.

The Contractor shall proceed with the work as changed and the value of the work shall be determined as provided in Claims for Extra Cost - Section 15.

Section 14 - Extension of Time

Extension of time stipulated in the Contract for completion of the work will be made if and as the Supervising Professional may deem proper under any of the following circumstances:

- (1) When work under an extra work order is added to the work under this Contract;
- (2) When the work is suspended as provided in Section 20;
- (3) When the work of the Contractor is delayed on account of conditions which could not have been foreseen, or which were beyond the control of the Contractor, and which were not the result of its fault or negligence;
- (4) Delays in the progress of the work caused by any act or neglect of the City or of its employees or by other Contractors employed by the City;
- (5) Delay due to an act of Government;
- (6) Delay by the Supervising Professional in the furnishing of plans and necessary information;
- (7) Other cause which in the opinion of the Supervising Professional entitles the Contractor to an extension of time.

The Contractor shall notify the Supervising Professional within 7 days of an occurrence or conditions which, in the Contractor's opinion, entitle it to an extension of time. The notice shall be in writing and submitted in ample time to permit full investigation and evaluation of the Contractor's claim. The Supervising Professional shall acknowledge receipt of the Contractor's notice within 7 days of its receipt. Failure to timely provide the written notice shall constitute a waiver by the Contractor of any claim.

In situations where an extension of time in contract completion is appropriate under this or any other section of the contract, the Contractor understands and agrees that the only available adjustment for events that cause any delays in contract completion shall be extension of the required time for contract completion and that there shall be no adjustments in the money due the Contractor on account of the delay.

Section 15 - Claims for Extra Cost

If the Contractor claims that any instructions by drawings or other media issued after the date of the Contract involved extra cost under this Contract, it shall give the Supervising Professional written notice within 7 days after the receipt of the instructions, and in any event before proceeding to execute the work, except in emergency endangering life or property. The procedure shall then be as provided for Changes in the Work-Section 13. No claim shall be valid unless so made.

If the Supervising Professional orders, in writing, the performance of any work not covered by the contract documents, and for which no item of work is provided in the Contract, and for which no unit price or lump sum basis can be agreed upon, then the extra work shall be done on a Cost-Plus-Percentage basis of payment as follows:

- (1) The Contractor shall be reimbursed for all reasonable costs incurred in doing the work, and shall receive an additional payment of 15% of all the reasonable costs to cover both its indirect overhead costs and profit;
- (2) The term "Cost" shall cover all payroll charges for employees and supervision required under the specific order, together with all worker's compensation, Social Security, pension and retirement allowances and social insurance, or other regular payroll charges on same; the cost of all material and supplies required of either temporary or permanent character; rental of all power-driven equipment at agreed upon rates, together with cost of fuel and supply charges for the equipment; and any costs incurred by the Contractor as a direct result of executing the order, if approved by the Supervising Professional;
- (3) If the extra is performed under subcontract, the subcontractor shall be allowed to compute its charges as described above. The Contractor shall be permitted to add an additional charge of 5% percent to that of the subcontractor for the Contractor's supervision and contractual responsibility;
- (4) The quantities and items of work done each day shall be submitted to the Supervising Professional in a satisfactory form on the succeeding day, and shall be approved by the Supervising Professional and the Contractor or adjusted at once;
- (5) Payments of all charges for work under this Section in any one month shall be made along with normal progress payments. Retainage shall be in accordance with Progress Payments-Section 16.

No additional compensation will be provided for additional equipment, materials, personnel, overtime or special charges required to perform the work within the time requirements of the Contract.

When extra work is required and no suitable price for machinery and equipment can be determined in accordance with this Section, the hourly rate paid shall be 1/40 of the basic weekly rate listed in the Rental Rate Blue Book published by Dataquest Incorporated and applicable to the time period the equipment was first used for the extra work. The hourly rate will be deemed to include all costs of operation such as bucket or blade, fuel, maintenance, "regional factors", insurance, taxes, and the like, but not the costs of the operator.

Section 16 - Progress Payments

The Contractor shall submit each month, or at longer intervals, if it so desires, an invoice covering work performed for which it believes payment, under the Contract terms, is due. The submission shall be to the City's Finance Department - Accounting Division. The Supervising Professional will, within 10 days following submission of the invoice, prepare a certificate for payment for the work in an amount to be determined by the Supervising Professional as fairly representing the acceptable work performed during the period covered by the Contractor's invoice. To insure the proper performance of this Contract, the City will retain a percentage of the estimate in accordance with Act 524, Public Acts of 1980. The City will then, following the receipt of the Supervising Professional's Certificate, make payment to the Contractor as soon as feasible, which is anticipated will be within 15 days.

An allowance may be made in progress payments if substantial quantities of permanent material have been delivered to the site but not incorporated in the completed work if the Contractor, in the opinion of the Supervising Professional, is diligently pursuing the work under this Contract. Such materials shall be properly stored and adequately protected. Allowance in the estimate shall be at the invoice price value of the items. Notwithstanding any payment of any allowance, all risk of loss due to vandalism or any damages to the stored materials remains with the Contractor.

In the case of Contracts which include only the Furnishing and Delivering of Equipment, the payments shall be; 60% of the Contract Sum upon the delivery of all equipment to be furnished, or in the case of delivery of a usable portion of the equipment in advance of the total equipment delivery, 60% of the estimated value of the portion of the equipment may be paid upon its delivery in advance of the time of the remainder of the equipment to be furnished; 30% of the Contract Sum upon completion of erection of all equipment furnished, but not later than 60 days after the date of delivery of all of the equipment to be furnished; and payment of the final 10% on final completion of erection, testing and acceptance of all the equipment to be furnished; but not later than 180 days after the date of delivery of all of the equipment to be furnished, unless testing has been completed and shows the equipment to be unacceptable.

With each invoice for periodic payment, the Contractor shall enclose a Contractor's Declaration - Section 43, and an updated project schedule per Order of Completion - Section 2.

Section 17 - Deductions for Uncorrected Work

If the Supervising Professional decides it is inexpedient to correct work that has been damaged or that was not done in accordance with the Contract, an equitable deduction from the Contract price shall be made.

Section 18 - Correction of Work Before Final Payment

The Contractor shall promptly remove from the premises all materials condemned by the Supervising Professional as failing to meet Contract requirements, whether incorporated in the work or not, and the Contractor shall promptly replace and re-execute the work in accordance with the Contract and without expense to the City and shall bear the expense of making good all work of other contractors destroyed or damaged by the removal or replacement.

If the Contractor does not remove the condemned work and materials within 10 days after written notice, the City may remove them and, if the removed material has value, may store the material at the expense of the Contractor. If the Contractor does not pay the expense of the removal within 10 days thereafter, the City may, upon 10 days written notice, sell the removed materials at auction or private sale and shall pay to the Contractor the net proceeds, after deducting all costs and expenses that should have been borne by the Contractor. If the

removed material has no value, the Contractor must pay the City the expenses for disposal within 10 days of invoice for the disposal costs.

The inspection or lack of inspection of any material or work pertaining to this Contract shall not relieve the Contractor of its obligation to fulfill this Contract and defective work shall be made good. Unsuitable materials may be rejected by the Supervising Professional notwithstanding that the work and materials have been previously overlooked by the Supervising Professional and accepted or estimated for payment or paid for. If the work or any part shall be found defective at any time before the final acceptance of the whole work, the Contractor shall forthwith make good the defect in a manner satisfactory to the Supervising Professional. The judgment and the decision of the Supervising Professional as to whether the materials supplied and the work done under this Contract comply with the requirements of the Contract shall be conclusive and final.

Section 19 - Acceptance and Final Payment

Upon receipt of written notice that the work is ready for final inspection and acceptance, the Supervising Professional will promptly make the inspection. When the Supervising Professional finds the work acceptable under the Contract and the Contract fully performed, the Supervising Professional will promptly sign and issue a final certificate stating that the work required by this Contract has been completed and is accepted by the City under the terms and conditions of the Contract. The entire balance found to be due the Contractor, including the retained percentage, shall be paid to the Contractor by the City within 30 days after the date of the final certificate.

Before issuance of final certificates, the Contractor shall file with the City:

- (1) The consent of the surety to payment of the final estimate;
- (2) The Contractor's Affidavit in the form required by Section 44.

In case the Affidavit or consent is not furnished, the City may retain out of any amount due the Contractor, sums sufficient to cover all lienable claims.

The making and acceptance of the final payment shall constitute a waiver of all claims by the City except those arising from:

- (1) unsettled liens;
- (2) faulty work appearing within 12 months after final payment;
- (3) hidden defects in meeting the requirements of the plans and specifications;
- (4) manufacturer's guarantees.

It shall also constitute a waiver of all claims by the Contractor, except those previously made and still unsettled.

Section 20 - Suspension of Work

The City may at any time suspend the work, or any part by giving 5 days notice to the Contractor in writing. The work shall be resumed by the Contractor within 10 days after the date fixed in the written notice from the City to the Contractor to do so. The City shall reimburse the Contractor for expense incurred by the Contractor in connection with the work under this Contract as a result of the suspension.

If the work, or any part, shall be stopped by the notice in writing, and if the City does not give notice in writing to the Contractor to resume work at a date within 90 days of the date fixed in the written notice to suspend, then the Contractor may abandon that portion of the work suspended and will be entitled to the estimates and payments for all work done on the portions

abandoned, if any, plus 10% of the value of the work abandoned, to compensate for loss of overhead, plant expense, and anticipated profit.

Section 21 - Delays and the City's Right to Terminate Contract

If the Contractor refuses or fails to prosecute the work, or any separate part of it, with the diligence required to insure completion, ready for operation, within the allowable number of consecutive calendar days specified plus extensions, or fails to complete the work within the required time, the City may, by written notice to the Contractor, terminate its right to proceed with the work or any part of the work as to which there has been delay. After providing the notice the City may take over the work and prosecute it to completion, by contract or otherwise, and the Contractor and its sureties shall be liable to the City for any excess cost to the City. If the Contractor's right to proceed is terminated, the City may take possession of and utilize in completing the work, any materials, appliances and plant as may be on the site of the work and useful for completing the work. The right of the Contractor to proceed shall not be terminated or the Contractor charged with liquidated damages where an extension of time is granted under Extension of Time - Section 14.

If the Contractor is adjudged a bankrupt, or if it makes a general assignment for the benefit of creditors, or if a receiver is appointed on account of its insolvency, or if it persistently or repeatedly refuses or fails except in cases for which extension of time is provided, to supply enough properly skilled workers or proper materials, or if it fails to make prompt payments to subcontractors or for material or labor, or persistently disregards laws, ordinances or the instructions of the Supervising Professional, or otherwise is guilty of a substantial violation of any provision of the Contract, then the City, upon the certificate of the Supervising Professional that sufficient cause exists to justify such action, may, without prejudice to any other right or remedy and after giving the Contractor 3 days written notice, terminate this Contract. The City may then take possession of the premises and of all materials, tools and appliances thereon and without prejudice to any other remedy it may have, make good the deficiencies or finish the work by whatever method it may deem expedient, and deduct the cost from the payment due the Contractor. The Contractor shall not be entitled to receive any further payment until the work is finished. If the expense of finishing the work, including compensation for additional managerial and administrative services exceeds the unpaid balance of the Contract Sum, the Contractor and its surety are liable to the City for any excess cost incurred. The expense incurred by the City, and the damage incurred through the Contractor's default, shall be certified by the Supervising Professional.

Section 22 - Contractor's Right to Terminate Contract

If the work should be stopped under an order of any court, or other public authority, for a period of 3 months, through no act or fault of the Contractor or of anyone employed by it, then the Contractor may, upon 7 days written notice to the City, terminate this Contract and recover from the City payment for all acceptable work executed plus reasonable profit.

Section 23 - City's Right To Do Work

If the Contractor should neglect to prosecute the work properly or fail to perform any provision of this Contract, the City, 3 days after giving written notice to the Contractor and its surety may, without prejudice to any other remedy the City may have, make good the deficiencies and may deduct the cost from the payment due to the Contractor.

Section 24 - Removal of Equipment and Supplies

In case of termination of this Contract before completion, from any or no cause, the Contractor, if notified to do so by the City, shall promptly remove any part or all of its equipment and supplies from the property of the City, failing which the City shall have the right to remove the equipment and supplies at the expense of the Contractor.

The removed equipment and supplies may be stored by the City and, if all costs of removal and storage are not paid by the Contractor within 10 days of invoicing, the City upon 10 days written notice may sell the equipment and supplies at auction or private sale, and shall pay the Contractor the net proceeds after deducting all costs and expenses that should have been borne by the Contractor and after deducting all amounts claimed due by any lien holder of the equipment or supplies.

Section 25 - Responsibility for Work and Warranties

The Contractor assumes full responsibility for any and all materials and equipment used in the construction of the work and may not make claims against the City for damages to materials and equipment from any cause except negligence or willful act of the City. Until its final acceptance, the Contractor shall be responsible for damage to or destruction of the project (except for any part covered by Partial Completion and Acceptance - Section 26). The Contractor shall make good all work damaged or destroyed before acceptance. All risk of loss remains with the Contractor until final acceptance of the work (Section 19) or partial acceptance (Section 26). The Contractor is advised to investigate obtaining its own builders risk insurance.

The Contractor shall guarantee the quality of the work for a period of one year. The Contractor shall also unconditionally guarantee the quality of all equipment and materials that are furnished and installed under the contract for a period of one year. At the end of one year after the Contractor's receipt of final payment, the complete work, including equipment and materials furnished and installed under the contract, shall be inspected by the Contractor and the Supervising Professional. Any defects shall be corrected by the Contractor at its expense as soon as practicable but in all cases within 60 days. Any defects that are identified prior to the end of one year shall also be inspected by the Contractor and the Supervising Professional and shall be corrected by the Contractor at its expense as soon as practicable but in all cases within 60 days.

The Contractor shall assign all manufacturer or material supplier warranties to the City prior to final payment. The assignment shall not relieve the Contractor of its obligations under this paragraph to correct defects.

Section 26 - Partial Completion and Acceptance

If at any time prior to the issuance of the final certificate referred to in Acceptance and Final Payment - Section 19, any portion of the permanent construction has been satisfactorily completed, and if the Supervising Professional determines that portion of the permanent construction is not required for the operations of the Contractor but is needed by the City, the Supervising Professional shall issue to the Contractor a certificate of partial completion, and immediately the City may take over and use the portion of the permanent construction described in the certificate, and exclude the Contractor from that portion.

The issuance of a certificate of partial completion shall not constitute an extension of the Contractor's time to complete the portion of the permanent construction to which it relates if the Contractor has failed to complete it in accordance with the terms of this Contract. The issuance of the certificate shall not release the Contractor or its sureties from any obligations under this Contract including bonds.

If prior use increases the cost of, or delays the work, the Contractor shall be entitled to extra compensation, or extension of time, or both, as the Supervising Professional may determine.

Section 27 - Payments Withheld Prior to Final Acceptance of Work

The City may withhold or, on account of subsequently discovered evidence, nullify the whole or part of any certificate to the extent reasonably appropriate to protect the City from loss on account of:

- (1) Defective work not remedied;
- (2) Claims filed or reasonable evidence indicating probable filing of claims by other parties against the Contractor;
- (3) Failure of the Contractor to make payments properly to subcontractors or for material or labor;
- (4) Damage to another Contractor.

When the above grounds are removed or the Contractor provides a Surety Bond satisfactory to the City which will protect the City in the amount withheld, payment shall be made for amounts withheld under this section.

Section 28 - Contractor's Insurance

- (1) The Contractor shall procure and maintain during the life of this Contract, including the guarantee period and during any warranty work, such insurance policies, including those set forth below, as will protect itself and the City from all claims for bodily injuries, death or property damage which may arise under this Contract; whether the acts were made by the Contractor or by any subcontractor or anyone employed by them directly or indirectly. The following insurance policies are required:

- (a) Worker's Compensation Insurance in accordance with all applicable state and federal statutes. Further, Employers Liability Coverage shall be obtained in the following minimum amounts:

Bodily Injury by Accident - \$500,000 each accident
Bodily Injury by Disease - \$500,000 each employee
Bodily Injury by Disease - \$500,000 each policy limit

- (b) Commercial General Liability Insurance equivalent to, as a minimum, Insurance Services Office form CG 00 01 07 98. The City of Ann Arbor shall be named as an additional insured. There shall be no added exclusions or limiting endorsements specifically for the following coverages: Products and Completed Operations, Explosion, Collapse and Underground coverage or Pollution. Further there shall be no added exclusions or limiting endorsements which diminish the City's protections as an additional insured under the policy. The following minimum limits of liability are required:

\$1,000,000	Each occurrence as respect Bodily Injury Liability or Property Damage Liability, or both combined.
\$2,000,000	Per Job General Aggregate
\$1,000,000	Personal and Advertising Injury
\$2,000,000	Products and Completed Operations Aggregate

- (c) Motor Vehicle Liability Insurance, including Michigan No-Fault Coverages, equivalent to, as a minimum, Insurance Services Office form CA 00 01 07 97. The City of Ann Arbor shall be named as an additional insured. There shall be no added exclusions or limiting endorsements which diminish the City's protections as an additional insured under the policy. Coverage shall include all owned vehicles, all non-owned vehicles and all hired vehicles. Further, the limits of liability shall be \$1,000,000 for each occurrence as respects Bodily Injury Liability or Property Damage Liability, or both combined.
 - (d) Umbrella/Excess Liability Insurance shall be provided to apply excess of the Commercial General Liability, Employers Liability and the Motor Vehicle coverage enumerated above, for each occurrence and for aggregate in the amount of \$1,000,000.
- (2) Insurance required under subsection (1)(b) and (1)(c) above shall be considered primary as respects any other valid or collectible insurance that the City may possess, including any self-insured retentions the City may have; and any other insurance the City does possess shall be considered excess insurance only and shall not be required to contribute with this insurance. Further, the Contractor agrees to waive any right of recovery by its insurer against the City.
 - (3) In the case of all Contracts involving on-site work, the Contractor shall provide to the City before the commencement of any work under this Contract documentation demonstrating it has obtained the above mentioned policies. Documentation must provide and demonstrate an unconditional 30 day written notice of cancellation in favor of the City of Ann Arbor. Further, the documentation must explicitly state the following: (a) the policy number; name of insurance company; name and address of the agent or authorized representative; name and address of insured; project name; policy expiration date; and specific coverage amounts; (b) any deductibles or self-insured retentions which shall be approved by the City, in its sole discretion; (c) that the policy conforms to the requirements specified. An original certificate of insurance may be provided as an initial indication of the required insurance, provided that no later than 21 calendar days after commencement of any work the Contractor supplies a copy of the endorsements required on the policies. Upon request, the Contractor shall provide within 30 days a copy of the policy(ies) to the City. If any of the above coverages expire by their terms during the term of this Contract, the Contractor shall deliver proof of renewal and/or new policies to the Administering Service Area/Unit at least ten days prior to the expiration date.
 - (4) Any Insurance provider of Contractor shall be admitted and authorized to do business in the State of Michigan and shall carry and maintain a minimum rating assigned by A.M. Best & Company's Key Rating Guide of "A-" Overall and a minimum Financial Size Category of "V". Insurance policies and certificates issued by non-admitted insurance companies are not acceptable unless approved in writing by the City.

Section 29 - Surety Bonds

Bonds will be required from the successful bidder as follows:

- (1) A Performance Bond to the City of Ann Arbor for the amount of the bid(s) accepted;
- (2) A Labor and Material Bond to the City of Ann Arbor for the amount of the bid(s) accepted.

Bonds shall be executed on forms supplied by the City in a manner and by a Surety Company

authorized to transact business in Michigan and satisfactory to the City Attorney.

Section 30 - Damage Claims

The Contractor shall be held responsible for all damages to property of the City or others, caused by or resulting from the negligence of the Contractor, its employees, or agents during the progress of or connected with the prosecution of the work, whether within the limits of the work or elsewhere. The Contractor must restore all property injured including sidewalks, curbing, sodding, pipes, conduit, sewers or other public or private property to not less than its original condition with new work.

Section 31 - Refusal to Obey Instructions

If the Contractor refuses to obey the instructions of the Supervising Professional, the Supervising Professional shall withdraw inspection from the work, and no payments will be made for work performed thereafter nor may work be performed thereafter until the Supervising Professional shall have again authorized the work to proceed.

Section 32 - Assignment

Neither party to the Contract shall assign the Contract without the written consent of the other. The Contractor may assign any monies due to it to a third party acceptable to the City.

Section 33 - Rights of Various Interests

Whenever work being done by the City's forces or by other contractors is contiguous to work covered by this Contract, the respective rights of the various interests involved shall be established by the Supervising Professional, to secure the completion of the various portions of the work in general harmony.

The Contractor is responsible to coordinate all aspects of the work, including coordination of, and with, utility companies and other contractors whose work impacts this project.

Section 34 - Subcontracts

The Contractor shall not award any work to any subcontractor without prior written approval of the City. The approval will not be given until the Contractor submits to the City a written statement concerning the proposed award to the subcontractor. The statement shall contain all information the City may require.

The Contractor shall be as fully responsible to the City for the acts and omissions of its subcontractors, and of persons either directly or indirectly employed by them, as it is for the acts and omissions of persons directly employed by it.

The Contractor shall cause appropriate provisions to be inserted in all subcontracts relative to the work to bind subcontractors to the Contractor by the terms of the General Conditions and all other contract documents applicable to the work of the subcontractors and to give the Contractor the same power to terminate any subcontract that the City may exercise over the Contractor under any provision of the contract documents.

Nothing contained in the contract documents shall create any contractual relation between any subcontractor and the City.

Section 35 - Supervising Professional's Status

The Supervising Professional has the right to inspect any or all work. The Supervising Professional has authority to stop the work whenever stoppage may be appropriate to insure the proper execution of the Contract. The Supervising Professional has the authority to reject all work and materials which do not conform to the Contract and to decide questions which arise in the execution of the work.

The Supervising Professional shall make all measurements and determinations of quantities. Those measurements and determinations are final and conclusive between the parties.

Section 36 - Supervising Professional's Decisions

The Supervising Professional shall, within a reasonable time after their presentation to the Supervising Professional, make decisions in writing on all claims of the City or the Contractor and on all other matters relating to the execution and progress of the work or the interpretation of the contract documents.

Section 37 - Storing Materials and Supplies

Materials and supplies may be stored at the site of the work at locations agreeable to the City unless specific exception is listed elsewhere in these documents. Ample way for foot traffic and drainage must be provided, and gutters must, at all times, be kept free from obstruction. Traffic on streets shall be interfered with as little as possible. The Contractor may not enter or occupy with agents, employees, tools, or material any private property without first obtaining written permission from its owner. A copy of the permission shall be furnished to the Supervising Professional.

Section 38 - Lands for Work

The Contractor shall provide, at its own expense and without liability to the City, any additional land and access that may be required for temporary construction facilities or for storage of materials.

Section 39 - Cleaning Up

The Contractor shall, as directed by the Supervising Professional, remove at its own expense from the City's property and from all public and private property all temporary structures, rubbish and waste materials resulting from its operations unless otherwise specifically approved, in writing, by the Supervising Professional.

Section 40 - Salvage

The Supervising Professional may designate for salvage any materials from existing structures or underground services. Materials so designated remain City property and shall be transported or stored at a location as the Supervising Professional may direct.

Section 41 - Night, Saturday or Sunday Work

No night or Sunday work (without prior written City approval) will be permitted except in the case of an emergency and then only to the extent absolutely necessary. The City may allow night work which, in the opinion of the Supervising Professional, can be satisfactorily performed at night. Night work is any work between 8:00 p.m. and 7:00 a.m. No Saturday work will be permitted unless the Contractor gives the Supervising Professional at least 48 hours but not

more than 5 days notice of the Contractor's intention to work the upcoming Saturday.

Section 42 - Sales Taxes

Under State law the City is exempt from the assessment of State Sales Tax on its direct purchases. Contractors who acquire materials, equipment, supplies, etc. for incorporation in City projects are not likewise exempt. State Law shall prevail. The Bidder shall familiarize itself with the State Law and prepare its Bid accordingly. No extra payment will be allowed under this Contract for failure of the Contractor to make proper allowance in this bid for taxes it must pay.

Section 43

CONTRACTOR'S DECLARATION

I hereby declare that I have not, during the period _____, 20____, to _____, 20____, performed any work, furnished any materials, sustained any loss, damage or delay, or otherwise done anything in addition to the regular items (or executed change orders) set forth in the Contract titled _____, for which I shall ask, demand, sue for, or claim compensation or extension of time from the City, except as I hereby make claim for additional compensation or extension of time as set forth on the attached itemized statement. I further declare that I have paid all payroll obligations related to this Contract that have become due during the above period and that all invoices related to this Contract received more than 30 days prior to this declaration have been paid in full except as listed below.

There is/is not (Contractor please circle one and strike one as appropriate) an itemized statement attached regarding a request for additional compensation or extension of time.

Contractor

Date

By _____
(Signature)

Its _____
(Title of Office)

Past due invoices, if any, are listed below.

Section 44

CONTRACTOR'S AFFIDAVIT

The undersigned Contractor, _____, represents that on _____, 20____, it was awarded a contract by the City of Ann Arbor, Michigan to _____ under the terms and conditions of a Contract titled _____. The Contractor represents that all work has now been accomplished and the Contract is complete.

The Contractor warrants and certifies that all of its indebtedness arising by reason of the Contract has been fully paid or satisfactorily secured; and that all claims from subcontractors and others for labor and material used in accomplishing the project, as well as all other claims arising from the performance of the Contract, have been fully paid or satisfactorily settled. The Contractor agrees that, if any claim should hereafter arise, it shall assume responsibility for it immediately upon request to do so by the City of Ann Arbor.

The Contractor, for valuable consideration received, does further waive, release and relinquish any and all claims or right of lien which the Contractor now has or may acquire upon the subject premises for labor and material used in the project owned by the City of Ann Arbor.

This affidavit is freely and voluntarily given with full knowledge of the facts.

Contractor

Date

By _____
(Signature)

Its _____
(Title of Office)

Subscribed and sworn to before me, on this ____ day of _____, 20____
_____, _____ County, Michigan

Notary Public

_____ County, MI

My commission expires on:

STANDARD SPECIFICATIONS

All work under this contract shall be performed in accordance with the Michigan Department of Transportation (MDOT) 2012 Standard Specifications for Construction. All work under this Contract which is not included in these Standard Specifications, or which is performed using modifications to these Standard Specifications, shall be performed in accordance with the City of Ann Arbor Detailed Specifications, MDOT Supplemental Specifications, and MDOT Special Provisions included in these contract documents. Any reference to the Michigan Department of Transportation (the "Department") in the above Standard Specifications, Supplemental Specifications, and Special Provisions shall also mean the City of Ann Arbor.

The Michigan Department of Transportation 2012 Standard Specification for Construction may be downloaded from the following web link:

<http://mdotcf.state.mi.us/public/specbook/2012/>

CITY OF ANN ARBOR

NOTICE TO BIDDERS

AA:DAD

1 of 2

04/05/15

Utilities Coordination

The Contractor shall cooperate and coordinate construction activities with the owners of utilities as stated in subsection 104.08 of the Standard Specifications for Construction. In addition, for the protection of underground utilities, the Contractor shall follow the requirements in subsection 107.12 of the Standard Specifications for Construction. Contractor delay claims resulting from a utility will be determined based upon subsection 108.09 of the Standard Specifications for Construction.

The following Utility Owners have facilities located within the Right-of-Way:

<u>Utility</u>	<u>Type of Service</u>
City of Ann Arbor W.R. Wheeler Service Center 4251 Stone School Road Ann Arbor, MI 48108 734 794-6351	Sanitary Sewer (Mark Cozart - ext. 43318) Water (Daniel Wooden - ext. 43324) Storm Sewer (Kevin Ernst - ext. 43327) Communications/Signs/Signals/Street Lighting (Chuck Fojtik - ext. 43322)
AT&T 550 South Maple Ann Arbor, MI 48103 Attn: Debora Renner 734-996-5485 debora.a.renner@att.com	Telephone/Fiber Optic
Comcast 27800 Franklin Road Southfield, MI 48034 Attn: Ron Southerland 248-359-6544 ronald_southerland@cable.comcast.com	Cable/Fiber Optic
DTE Energy 2000 2 nd Ave, Room 518 S.B. Detroit, MI 48226 Attn: Julie Gottardi 734-884-0585 gottardij@dteenergy.com	Electric
DTE Energy (Michcon) 17150 Allen Road Melvindale, MI 48122 Attn: Laurie Forrester 313-389-7261 forresterl@dteentergy.com	Gas

CITY OF ANN ARBOR

NOTICE TO BIDDERS

AA:DAD

2 of 2

04/05/15

MCI/Verizon
5688 W Grand River Avenue
Lansing, MI 48906
Attn: Rick Chalmers
517-318-8064
rick.chalmers@verizonbusiness.com

Telephone/Fiber Optic

For protection of underground utilities, the Contractor shall call "MISS DIG" toll free at 1-800-482-7171 or call 811 a minimum of three (3) working days prior to excavation within the project limits. The Contractor must also notify utility owners who may not be part of the "MISS DIG" system.

The Contractor shall notify the City of Ann Arbor a minimum of three (3) days prior to beginning construction.

The Owners of public or private utilities which will not interfere with the completed project and which do not present a hazard to the public or an extraordinary hazard to the Contractor's operations will not be required to move their facilities on or from the street right-of-way.

The Contractor shall verify the location and depth of all utilities through Miss Dig and coordinate with the utilities to ensure that all utilities are protected during the project.

Protection of existing utility facilities is necessary during the project. Protection may include: holding utility poles, supporting underground facilities, temporary sheeting, bracing, poles, cables, sand fill or other means to complete the work. The Contractor is responsible for furnishing all labor, equipment and materials required to protect existing facilities during construction. Costs associated with protecting existing utilities will not be paid for separately.

CITY OF ANN ARBOR
DETAILED SPECIFICATION
FOR
GENERAL CONDITIONS

AA:DAD

1 of 2

02/23/16

a. Description. This item shall include all work described and required by the Plans and Specifications at each location for which no item of work is listed in the Bid Form, including but not limited to:

- Scheduling, coordination, and organization of all work, subcontractors, suppliers, testing, inspection, surveying, and staking.
- Coordination of, and cooperation with, other contractors, agencies, departments, and utilities.
- Protection and maintenance of utilities.
- Placing, maintaining, and removing all soil erosion and sedimentation controls, including stone inlets filers (as shown on project plants).
- Maintaining drainage.
- Maintaining driveways drive openings, sidewalks, bike paths, mail deliveries, and solid waste/recycle pick-ups. This includes the placement and maintenance of gravel in driveway openings as directed by the Engineer.
- Storing all materials and equipment off lawn areas.
- Temporary relocation and final replacement/re-setting of mailboxes.
- Site clean-up.
- Coordination efforts to furnish various HMA mixtures as directed by the Engineer
- Coordination efforts to furnish and operate various-size vehicles/equipment as directed by the Engineer
- Furnishing and operating vacuum-type street cleaning equipment a minimum of once per week or more frequently as directed by the Engineer
- Furnishing and operating vacuum-type utility structure cleaning equipment
- Furnishing and operating both vibratory plate and pneumatic-type (“pogo-stick”) compactors
- Furnishing and operating a backhoe during all work activities
- Furnishing and operating a jackhammer and air compressor during all work activities
- Noise and dust control
- Mobilization(s) and demobilization(s).
- Furnishing submittals and certifications for materials and supplies
- Disposing of excavated materials and debris - The Contractor shall dispose of, at the Contractor’s expense, all excavated material. Costs for this work will not be paid for separately.
- All miscellaneous and incidental items such as overhead, insurance, and permits.

- Meeting all requirements relating to Debarment Certification, Davis Bacon Act, and Disadvantaged Business Enterprise, and providing the necessary documentation.

Data pertaining to existing soil borings and pavement sections, which are included in the Appendix of these Contract Documents, are provided to help the Engineer and Contractor determine the soil conditions existing within the construction area. The City in no way guarantees existing conditions to be the same as shown in the data. The Contractor is solely responsible for any and all conclusions he/she may draw from the data.

Quantities as given are approximate and are estimated for bidding purposes. Quantities are not guaranteed and may vary by any amount. While it is the City's intent to complete the project substantially as drawn and specified herein, quantities may be changed or reduced to zero for cost savings or other reasons. **The City reserves the right to change the quantities, and no adjustment in unit price will be made for any change in any quantity.**

b. Materials. None Specified.

c. Construction. Not specified.

d. Measurement and Payment. The completed work, as described, will be measured and paid for at the contract unit price for the following pay item:

<u>Pay Item</u>	<u>Pay Unit</u>
General Conditions, Max \$75,000.....	Lump Sum

This item of work will be paid for on a pro rata basis at the time of each progress payment. Measurement will be based on the ratio between work completed during the payment period and the total contract amount. When all of the work of this Contract has been completed, the measurement of this item shall be 1.0 Lump Sum, minus any deductions incurred for inadequate performance as described herein. This amount will not be increased for any reason, including extensions of time, extras, and/or additional work.

The unit price for this item of work shall include all labor, material, and equipment costs to perform all the work specified in the Standard Specifications and as modified by this Detailed Specification.

CITY OF ANN ARBOR
DETAILED SPECIFICATION
FOR
PROJECT SUPERVISION

AA:DAD

1 of 4

02/23/16

a. Description. The Contractor shall provide supervision in accordance with the City of Ann Arbor Standard Specifications, subsections 104.07 and 107.15 of the Michigan Department of Transportation (MDOT) 2012 Standard Specifications for Construction, and as described herein.

The Contractor shall designate a full-time Project Supervisor to act as the Contractor's agent/representative, and to be responsible for scheduling and coordination of all subcontractors, suppliers, other governmental agencies, and all public and private utility companies.

The Project Supervisor shall not be an active crew member of the Contractor, shall not be an active member or employee of any subcontractor's work force, and shall not perform general or specialized labor tasks. The Project Supervisor shall be a full-time employee of the General Contractor and shall have all needed authority to make binding decisions on behalf of the Contractor in all matters pertaining to performance and execution of the work of the project.

The Project Supervisor shall work exclusively on this project, and shall put forth his/her full effort into the organization and coordination of the work of this project.

One week prior to the pre-construction meeting, the Contractor shall designate a proposed Project Supervisor by name, and shall furnish the Engineer with a current, thorough, detailed summary of the proposed Project Supervisor's work history, outlining all previous supervisory experience on projects of a similar size and nature. The detailed work history shall include personal and professional references (names and phone numbers) of persons (previous owners or agents) who can attest to the qualifications and work history of the proposed Project Supervisor. Proposed candidates for Project Supervisor shall have a demonstrated ability to work harmoniously with the Engineer, the City, the public, subcontractors, and all other parties typically involved with work of this nature. The Engineer will have the authority to reject a proposed Project Supervisor whom he/she considers unqualified.

The Project Supervisor shall be available 24 hours-per-day to provide proper supervision, coordination and scheduling of the project for the duration of the Contract. The Contractor shall furnish the City with telephone numbers of the Project Supervisor in order to provide 24 hour-per-day access during business and non-business hours, including weekends and holidays.

The Project Supervisor shall be equipped by the Contractor with a "smart" mobile telephone with "data" and "text" capabilities to provide the City with 24 hour-per-day access to him/her during daily construction activities, during transit to and from the construction site, and during all non-business hours including weekends and holidays.

The Project Supervisor shall be equipped with assistants as necessary to provide project supervision as specified herein, and in accordance with the Contract.

CITY OF ANN ARBOR
DETAILED SPECIFICATION
FOR
PROJECT SUPERVISION

AA:DAD

2 of 4

02/23/16

1. Duties and Responsibilities. The Project Supervisor shall work harmoniously with the Engineer, the City, the public, subcontractors, and all other parties typically involved with work of this nature.

The Project Supervisor shall have a thorough, detailed understanding and working knowledge of all construction practices and methods specified elsewhere herein, as well as the handling, placement, testing and inspection of aggregates, aggregate products, bituminous concrete, Portland cement concrete materials, and other such materials and products related to the work of this project.

The Project Supervisor shall be responsible for all of the work of all of the Contractor's, subcontractors' and suppliers' work forces.

The Project Supervisor shall be responsible for proper and adequate maintenance (emissions, safety, and general operation) of all of the Contractor's, subcontractors' and suppliers' equipment and vehicles. The Project Supervisor shall make all needed diligent and good-faith efforts to ensure that all equipment utilized in the performance of the work is properly maintained, safe, and complies with all legal and environmental requirements of the work as set forth in section 107.15 of the MDOT 2012 Standard Specifications for Construction.

The Project Supervisor shall be responsible for the legal, proper and safe parking/storage of all of the Contractor's, subcontractors' and suppliers' equipment, work vehicles, and employee's vehicles.

The Project Supervisor shall schedule and coordinate the work of all parties involved in the project, including utility companies, testing agencies, governmental agencies, all City departments (such as Utilities and Transportation), and City inspectors.

The Project Supervisor shall coordinate and schedule the work of any independent survey crews that may be retained by the Engineer or City to witness and reset existing and new geographic/benchmark monuments. Failure to have existing monuments witnessed and reset may result in delays to the Contractor's work. Costs for such delays will be the Contractor's sole responsibility. The Project Supervisor shall also schedule and complete all needed survey request forms that are needed in order to schedule the services of survey personnel to properly layout all elements of the project work in accordance with the City of Ann Arbor Public Services Area Standard Specifications and the MDOT 2012 Standard Specifications for Construction.

The Project Supervisor shall coordinate and schedule inspection performed by the City and Consultants (including material testing firms) in a timely manner, to assure proper and timely testing and inspection of the work.

CITY OF ANN ARBOR
DETAILED SPECIFICATION
FOR
PROJECT SUPERVISION

AA:DAD

3 of 4

02/23/16

The Project Supervisor shall submit to the Engineer, an updated, detailed schedule of the proposed work on a weekly basis, and an update of all proposed changes on a daily basis.

The Project Supervisor and all subcontractors shall attend a weekly progress meeting chaired by the Engineer to discuss the work. Upon the completion of each meeting, the Engineer shall prepare and distribute, to all present, a written summary of the meeting's minutes. Those in attendance shall review the minutes and, if necessary, comment on any deficiencies or errors prior to or at the next scheduled progress meeting.

2. Additional Performance Requirements. If, in the sole opinion of the Engineer, the Project Supervisor is not adequately performing the duties as outlined in this Special Provision, the following system of notices will be given to the contractor with the associated penalties:

First Notice – A warning will be issued in writing to the Contractor detailing the deficiencies in the Project Supervision. The Contractor must respond within 7 calendar days in writing with a plan to correct the stated deficiencies. Failure to respond within 7 calendar days will result in the issuing of a second notice.

Second Notice – A second warning will be issued in writing to the contractor further detailing the deficiencies in the Project Supervision. A deduction of 10%, or \$10,000, whichever is greater, will be made from the original Project Supervision contract amount. The Contractor must respond within 7 calendar days in writing with a plan to correct the stated deficiencies. Failure to respond within 7 calendar days will result in the issuing of a third notice. At this time, the Engineer reserves the right to meet with personnel with the necessary authority within the Contractor's organization to discuss the deficiencies in the Project Supervision.

Third Notice – A third notice will be issued in writing to the Contractor further detailing the deficiencies in the Project Supervision. An additional deduction of 25%, or \$25,000, whichever is greater, will be made from the original Project Supervision contract amount, and the Project Supervisor shall be removed from the project, and replaced immediately with another individual to be approved by the Engineer.

Should, in the sole opinion of the Engineer, the Project Supervisor fail to perform his/her duties and responsibilities as described herein to such a degree that the successful completion of the project is put in jeopardy, the above system of notices may be foregone, and the Contractor shall immediately replace the Project Supervisor upon receipt of written notice. Failure to provide adequate project supervision, as determined by the Engineer, shall be considered basis for the Engineer to suspend work without extension of contract time or additional compensation.

If the original Project Supervision contract amount is insufficient to cover said deductions, the Project Supervision contract amount will be reduced to zero and a

CITY OF ANN ARBOR
DETAILED SPECIFICATION
FOR
PROJECT SUPERVISION

AA:DAD

4 of 4

02/23/16

contract modification will be written to assess a penalty to cover the difference between the Project Supervision contract amount and the total amount of the deduction(s). It is fully expected however that the Project Supervision contract amount will be sufficient to cover any deductions.

b. Materials. None Specified.

c. Construction. Not specified.

d. Measurement and Payment. The completed work, as described, will be measured and paid for at the contract unit price for the following pay item:

<u>Pay Item</u>	<u>Pay Unit</u>
Project Supervision, Max \$100,000	Lump Sum

The unit price for this item of work shall include all labor, material, and equipment costs to perform all the work specified in the Standard Specifications, and as modified by this Detailed Specification.

Payment for this work will be made with each progress payment, on a pro rata basis, based on the percentage of construction completed. When all of the work of this Contract has been completed, the measurement of this item shall be 1.0 times the Lump Sum bid amount, minus any deductions incurred for inadequate performance as described herein. This amount will not be increased for any reason, including extensions of time, extras, adjustments and/or additional work.

CITY OF ANN ARBOR
DETAILED SPECIFICATION
FOR
VACUUM TYPE CLEANING EQUIPMENT

AA:DAD

1 of 1

04/08/15

a. Description. This work includes furnishing and operating throughout the construction period, vacuum type street cleaning and utility structure cleaning equipment (Vac-All, Vactor, etc.) approved by the Engineer, as and when directed by the Engineer for dust control, for dirt/debris control, and for street cleaning immediately prior to paving, and for street and utility structure cleaning after any and all paving.

b. Materials. None specified.

c. Construction. The Contractor shall furnish and operate throughout the construction period, vacuum type street cleaning and utility structure cleaning equipment (Vac-All, Vactor, etc.) approved by the Engineer. When directed by the Engineer, the Contractor shall use this equipment to control dust, dirt, and other debris within the project limits and beyond as required, to clean streets surfaces immediately prior to placing HMA pavement mixtures, and for street and utility structure cleaning after any and all paving. The cleaning equipment shall be of sufficient power to remove dust, dirt, and debris from the pavement and from utility structures in and adjacent to the construction area.

d. Measurement and Payment. Costs for this work will not be paid for separately, but shall be included in the Contract pay Item "General Conditions, Maximum, \$___".

CITY OF ANN ARBOR
DETAILED SPECIFICATION
FOR
MATERIAL AND SUPPLIES CERTIFICATIONS

AA:DAD

1 of 1

04/08/15

a. Description. This work includes furnishing certifications to the Engineer for review and approval a minimum of three business days prior to any scheduled delivery, installation, and/or construction of same. The following materials and supplies shall be certified by the manufacturer or supplier as having been tested for compliance with the Specifications:

- HMA materials
- Hot-poured Joint Sealants
- Cements, coatings, admixtures and curing materials
- Sands and Aggregates
- Steel and Fabricated metal
- Portland Cement Concrete Mixtures
- Reinforcing Steel for Concrete
- Reinforcing Fibers for Concrete
- Pre-cast Concrete products
- Sanitary Sewer Pipe
- Storm Sewer Pipe
- Water Main Pipe
- Corrugated Metal Pipe
- High Density Polyethylene Pipe
- Timber for retaining walls
- Modular Concrete Block for retaining walls
- Edge Drain and Underdrain Pipe
- Geotextile Filter Fabric and Stabilization Fabric/Grids

b. Materials. None specified.

c. Construction. Not specified.

d. Measurement and Payment. Costs for this work will not be paid for separately, but shall be included in the Contract pay Item "General Conditions, Maximum, \$___".

CITY OF ANN ARBOR
DETAILED SPECIFICATION
FOR
PROJECT SCHEDULE

AA:DAD

1 of 2

02/23/16

The entire work under this Contract shall be completed in accordance with, and subject to, the scheduling requirements as outlined below, and all other requirements of the Contract Documents.

The Contractor shall organize, coordinate and diligently execute the work, in the approximate order shown on the Street List & Schedule shown herein. The Street List & Schedule details requirements for Starting Dates, Completion Dates, and Restricted Dates for each street, as well as the maximum number of calendar days allowed to complete each street. For the purpose of this Contract, "Beginning of Work" is defined as the date of installation of the "No-Parking" signs. "Completion of Work" is defined as the completion of the work as specified herein and as directed by the Engineer (including, but not limited to, driveway wedging, surface restoration, clean-up, street cleaning, underground utility structure cleaning, and the removal of all temporary traffic control devices and "No Parking" signs).

The Engineer shall limit the Contractor's work operations to a number of streets that, in the opinion of the Engineer, is reasonable to allow for proper and thorough inspection, and to reduce traffic control and/or safety problems. The contractor shall not have more than three (3) streets "active" at any given time. A street is considered "active" if work on the street has begun but has not yet been completed.

The Contractor is expected to be furnished with two (2) copies of the Contract, for its execution, on or before **April 19, 2016**. The Contractor shall properly execute both copies of the Contract and return them, with the required Bonds and Insurance documentation, to the City by **April 29, 2016**. The Contractor shall not begin the work before the applicable date(s) as described herein without approval from the Project Engineer, and in no case before the receipt of the fully executed Contract and Notice to Proceed.

By no later than **April 25, 2016** the Contractor shall submit a detailed schedule of work (progress schedule) for the Engineer's review and approval. The progress schedule must fully comply with the scheduling requirements contained on the Street List & Schedule in this Detailed Specification. The schedule shall clearly indicate, in detail, the start and the finish date of each work task on each street. Work shall not start until the progress schedule is approved in writing by the Engineer. The Contractor shall update the approved progress schedule each week, and present it to the Engineer at the weekly progress meeting, and must consult with the Engineer daily, for his/her review, and gain his/her approval, of any proposed deviations from the most current, approved, schedule.

The Contractor shall begin the work of this project on or before **May 9, 2016**, and only upon receipt of the fully executed Contract and Notice to Proceed. Appropriate time extensions shall be granted if the Notice to Proceed is delayed beyond this date.

The entire project shall be completed on or before **October 15, 2015**. The contract is considered complete when the project is ready for use and all restoration and pavement markings have been completed.

Failure to complete all work as specified herein within the times specified herein, including time extensions granted thereto as determined by the Engineer, shall entitle the City to deduct from the payments due the Contractor, the dollar amounts specified in the Street List & Schedule as

“Liquidated Damages” for delays in the completion of the work for each incomplete street, for each and every calendar day.

Time is of the essence in the performance of the work of this contract. The Contractor is expected to mobilize sufficient personnel and equipment and work throughout all authorized hours to complete the project by the final completion date. Should the Contractor demonstrate that they must work on some Sundays in order to maintain the project schedule, they may do so between the hours of 9:00 a.m. and 5:00 p.m. with prior approval from the City. There will be no additional compensation due to the Contractor for work performed on Sundays.

The Engineer may delay or stop the work due to threatening weather conditions. The Contractor shall not be compensated for unused materials or downtime due to rain, or the threat of rain. The Contractor is solely responsible for repairing all damages to the work and to the site, including road infrastructures, road subgrades, and any adjacent properties, which are caused as a result of working in the rain.

The Contractor shall not work in the dark except as approved by the Engineer and only when lighting for night work is provided as detailed elsewhere in this contract. The Engineer may stop the work, or may require the Contractor to defer certain work to another day, if, in the Engineer's opinion, the work cannot be completed within the remaining daylight hours, or if inadequate daylight is present to either properly perform or inspect the work. The Contractor will not be compensated for unused materials or downtime, when delays or work stoppages are directed by the Engineer for darkness and/or inadequate remaining daylight reasons. The Contractor is solely responsible for repairing all damages to the work and to the site, including road infrastructures, road subgrades, and any adjacent properties, which are caused as a result of working in the dark.

Liquidated Damages will be assessed until the required work is completed in the current construction season. If, with the Engineer's approval, work is extended beyond seasonal limitations, the assessment of Liquidated Damages will be discontinued until the work is resumed in the following construction season.

If the construction contract is not completed within the specified period(s) including any extensions of time granted thereto, at the sole discretion of the City of Ann Arbor, this Contract may be terminated with no additional compensation due to the Contractor, and the Contractor may be forbidden to bid on future City of Ann Arbor projects for a period of at least three (3) years. If the Engineer elects to terminate the Contract, contract items paid for on a Lump Sum basis shall be paid up to a maximum percentage equal to the percentage of the contract work that has been completed.

The City's decision to delete streets, add streets, change the construction limits on streets, or, the City's contribution to a delay of the construction on any one street shall not entitle the Contractor to receive additional compensation for work on any other street(s), nor shall it relieve the Contractor of any responsibilities for completion of work on any other street(s).

Costs for the Contractor to organize, coordinate, and schedule all of the project work will not be paid for separately, but shall be included in the bid price of the Contract Item “General Conditions, Modified, Maximum, \$_”

CITY OF ANN ARBOR
DETAILED SPECIFICATION
FOR
REMOVING CONCRETE ITEMS

AA:DAD

1 of 2

02/23/16

a. Description. This work shall consist of removing concrete curb, gutter, curb and gutter, integral curb, sidewalk, sidewalk ramps, drive openings, and drive approach pavements as shown on the plans, in accordance with section 204 of the Michigan Department of Transportation (MDOT) 2012 Standard Specifications for Construction, except as specified herein, and as directed by the Engineer.

b. Materials. Materials shall be in accordance with those specified in section 204 of the MDOT Standard Specifications for Construction.

c. Construction. Construction methods shall be as described in section 204 of the MDOT 2012 Standard Specifications for Construction, as described below, and as directed by the Engineer.

Curb, gutter, curb and gutter, sidewalk, sidewalk ramps, drive openings, and drives shall be replaced within 24 hours of their removal.

Prior to the start of work, the Engineer and Contractor together shall identify and field measure all items to be removed. The Engineer shall approve of all removal limits prior to any removals being performed by the Contractor.

The Contractor shall perform full-depth saw cutting at removal limits, including those necessary to construct 2-foot wide MDOT Type M drive openings, and including those necessary to provide for the partial removal of existing drive approaches as shown on the Plans, as directed by the Engineer, and as marked for removal. The Contractor shall cut steel reinforcement bars as directed by the Engineer at all areas of removal. All saw cutting shall be performed under wet conditions to prevent excessive airborne dust. All resulting slurry and debris shall be cleaned up to the satisfaction of the Engineer.

The Contractor shall excavate, cut, remove stumps, remove brush, grade, and trim as needed and as directed, and shall import, furnish, fill, place, grade, and compact granular material as needed to complete the following: construct new concrete items; to repair or replace existing concrete items; to relocate existing concrete items to their new specified/directed elevations/locations, including all necessary grading at elevation changes of curb and gutter, sidewalks and ramps; and at locations where existing concrete items are to be removed and turf is to be established in its place.

The Contractor shall coordinate with the City Forester prior to the removal of any tree roots.

At various times throughout the work, the Engineer may direct the Contractor to use smaller and/or lighter equipment, and to defer certain work tasks, in order to protect the grade and/or adjacent areas. The Contractor shall not be entitled to any additional compensation for the use of smaller equipment, lighter equipment, or work task deferral.

The Contractor shall shape, grade, and compact the existing roadbed materials to the cross-section(s) as indicated on the Plans, as detailed in the Specifications, and as directed by the Engineer.

The Contractor shall use blade graders, maintainers, vibratory rollers, and/or other equipment as necessary, and as directed by the Engineer. The use of each specific piece of equipment is subject to the approval of the Engineer.

Where existing concrete curb or curb and gutter is to be replaced on a street with a concrete (or brick) base, the Engineer may direct the Contractor to remove a 1-to-2-foot wide, full-depth section of pavement and pavement base from immediately in front of the curb and gutter. As part of this pavement/base removal, the Contractor shall perform additional (double) full-depth saw-cutting along the entire removal limits, and shall take sufficient care so as not to damage and/or disturb any adjacent pavement, pavement base, and/or any other site feature, all as directed by the Engineer. The removals shall be to a sufficient width and depth to allow for the placement and removal of the curb and gutter formwork. After the removal of the formwork, the Contractor shall replace the concrete base to its original thickness and elevation(s).

Excavated/removal areas shall be adequately protected with barricades and/or fencing at all times.

Removed or excavated materials which are not incorporated into the work shall become the property of the Contractor and shall be immediately removed and properly disposed of off-site. Removed or excavated materials may not be stockpiled overnight on, or adjacent to, the site.

Base, subbase, or subgrade materials removed without authorization by the Engineer shall be replaced and compacted by the Contractor at the Contractor's expense, with materials specified by the Engineer.

d. Measurement and Payment. The completed work, as described, will be measured and paid for at the respective contract unit prices for the following respective pay items:

<u>Pay Item</u>	<u>Pay Unit</u>
Curb, Gutter, and Curb and Gutter, Any Type, Rem	Square Yard
Sidewalk, Sidewalk Ramp, and Driveway Approach, Any Thickness, Rem	Square Yard

Basis of payment shall be as described in subsection 205.04 of the Standard Specifications for Construction.

All sawcutting required for removals shall be included in the appropriate item of work, and will not be paid for separately. Payment for saw cutting to create or modify Type M openings and to allow for the partial removal of existing drives shall be included in the price of the item of work, "Sidewalk, Sidewalk Ramp, and Driveway Approach, Any Thickness, Rem".

CITY OF ANN ARBOR
DETAILED SPECIFICATION
FOR
MACHINE GRADING

AA:DAD

1 of 7

02/23/16

a. Description. Machine grading shall be completed in accordance with section 205 of the Michigan Department of Transportation (MDOT) 2012 Standard Specifications for Construction as shown on the plans, and as specified herein, with the exception that subgrade undercutting shall be paid for separately for applicable work when this pay item is included in the proposal. Machine grading shall include all the work specified herein for which there is no separate pay item. This work shall consist of constructing earth grades by excavating, cutting, filling, trimming, and grading; general restoration, and sign removals in accordance with the Detailed Specifications elsewhere herein; and maintaining the work in a finished condition until such time that it is accepted by the Engineer.

b. Materials. All materials shall meet the requirements as specified in section 205 of the MDOT 2012 Standard Specifications for Construction, except as specified herein.

c. Construction. All construction methods shall meet the requirements as specified in section 205 of the MDOT 2012 Standard Specifications for Construction, except as specified herein.

1. Soils Information - Soil information provided as part of the contract documents is for informational purposes only and shall not relieve the Contractor of the responsibility of investigating all local conditions before bidding.
2. General Provisions - The Contractor shall:
 - A. Maintain access to all drive entrances at all times.
 - B. Maintain pick-up access for garbage and recycle vehicles at all times.
 - C. Maintain access to all mail boxes for users and the U.S. Postal Service at all times. The Engineer may direct the temporary relocation of mail boxes. The Contractor may propose the temporary relocation of mail boxes, subject to the approval of the Engineer. In either case, the temporary relocation of mail boxes will not be paid for separately. There are 22 mailboxes located within the project grading limits that may need to be temporarily relocated and then re-established in their permanent locations.
 - D. Grade around mailboxes, trees, light poles, power poles, and the like, which are to remain in place. The Contractor shall be responsible for any damage caused to such structures.
 - E. Coordinate all work with utility companies and others that need to complete work within the project limits.
 - F. Maintain the work in a finished condition until it is accepted by the Engineer.
3. Pavement Sawcutting - The work shall include the full-depth saw-cutting of pavement at the construction limits, and elsewhere as required, if not paid for as part of another item of work. Pavement sawcutting will not be paid for separately.
4. Removal of Trees and Vegetation - The Contractor shall remove and properly dispose of off-site all vegetation; brush; roots; and trees and stumps less than 6 inch in diameter, as shown on the plans, and as directed by the Engineer as required to complete the project.

5. Removal and Salvaging of Topsoil - The removal, salvaging and stockpiling of topsoil, and all related work, shall be performed in accordance with subsection 205.03.A.1 (Removing and Salvaging Topsoil) of the MDOT 2012 Standard Specifications for Construction and will not be paid for separately.

6. Miscellaneous Removals - The removal of HMA, aggregate, and/or concrete materials from around manholes, structures, and utility covers, and the removal of HMA curbing, HMA driveway wedges, HMA surface on existing curb and gutter, and HMA surfaces required for removal in other miscellaneous areas shall be paid for as "Machine Grading, Special" and will not be paid for separately.

"Machine Grading, Special" includes the removal of any surface feature located within the grading limits which must be removed and for which there is no specific pay item established in the proposal for its removal.

7. Protection of the Grade - The work shall be kept well drained at all times. Foundation, roadway embankment or subgrade that becomes damaged by rain shall be undercut and backfilled, or otherwise remedied, by the Contractor, at his/her sole expense, as directed by the Engineer.

The Contractor shall be responsible for the maintenance of the foundation, roadway embankment, and subgrade. Any damage caused, by traffic or the Contractor's operations, to the foundation, roadway embankment or subgrade, in the opinion of the Engineer, shall be remedied by the Contractor at his/her sole expense, as directed by the Engineer.

The Contractor shall not use rubber-tired equipment on the foundation, roadway embankment, or subgrade, when its use causes, in the opinion of the Engineer, unnecessary damage to the foundation, road embankment or subgrade. The Contractor shall conduct his/her operations and provide the necessary equipment to ensure the satisfactory completion of the work without damaging the foundation, roadway embankment or subgrade. This may require the transporting and movement of materials over additional distances.

At various times throughout the work, the Engineer may direct the Contractor to use smaller and/or lighter equipment, and to defer certain work tasks, in order to protect the grade and/or adjacent areas. The Contractor shall not be entitled to an extension of time or any additional compensation for the use of smaller equipment, lighter equipment, or work task deferral.

8. Protection of Utilities - Utility lines may become exposed at, above, or below, the foundation or subgrade elevation during machine grading or subgrade undercutting operations. If this occurs, the Contractor shall excavate around, above and/or below the utility lines, as directed, to complete the machine grading or subgrade undercutting operations. Payment, at contract unit prices, for "Machine Grading, Special" or "Subgrade Undercutting, Type __," whichever applies, will be considered as payment in full for this work.

9. Removal of Cable, Conduits and Pipe - The Contractor shall remove, and properly dispose of off-site, all abandoned cables, conduit, and pipe encountered at, or above the bottom of any earthwork excavation or undercut. Where the inverts of abandoned, or to be abandoned or removed, conduits or pipe are less than 16 inches below the bottom of any earth excavation or undercut, the conduits and/or pipe shall be removed and the resulting void filled with an Engineer approved material. The fill material shall be compacted to 95% of its maximum unit weight in lifts not exceeding 12 inches. No separate payment will be made for removal of conduit or pipe, or any of the work, described in this section.

10. Foundation Preparation - Foundation is defined as the original earth grade upon which roadway embankment is placed. The foundation work shall be completed in accordance with subsection 205.03.A (Preparing Roadway Foundation) of the MDOT 2012 Standard Specifications for Construction as shown on the plans, and as specified herein.

The foundation shall be compacted to 95% of its maximum unit weight, as measured by the AASHTO T-180 method, to a depth of at least 10 inches. If this cannot be achieved, in the opinion of the Engineer, he/she will direct the Contractor to perform "Subgrade Undercutting, Type ___" or "Subgrade Manipulation," as described herein, on the foundation.

11. Roadway Embankment Construction - Roadway embankment is defined as the construction of earth on the prepared foundation to form the subgrade. Roadway embankment work shall be completed in accordance with subsection 205.03 H (Roadway Embankment) of the MDOT 2012 Standard Specifications for Construction as shown on the plans, and as specified herein. Roadway embankment shall be compacted to a minimum of 95% of its maximum unit weight, as measured by the AASHTO T-180 method.

12. Subgrade Construction - Subgrade is defined as the final earth grade which extends from grading limit to grading limit. The subgrade shall be constructed by performing earth excavation and roadway embankment work in accordance with subsection 205.03.G (Earth Excavation) and subsection 205.03 H (Roadway Embankment) of the MDOT 2012 Standard Specifications for Construction, as shown on the plans, and as specified herein.

The subgrade shall be constructed to the contours and cross-sections shown on the plans, as specified herein, and as directed by the Engineer. To achieve this, the work shall include, but not be limited to:

- A. Removal and disposal off-site of any surplus or unsuitable materials.
- B. Furnishing from off-site any additional Engineer approved fill materials necessary.
- C. Moving existing and/or furnished materials longitudinally and transversely as necessary.
- D. Cutting, placing, compacting, and trimming existing and/or furnished materials to construct the roadway embankment and subgrade to the specified tolerances.
- E. Stockpiling, and moving again, any cut materials which cannot be immediately placed upon excavation due to construction staging.

The subgrade shall be graded to accommodate all subbases and aggregate bases wherever used, all bioswale and adjacent planting beds, all roadway pavements, curb and gutter, driveways, sidewalks, bicycle paths, other similar structures, bioswale planting mix, topsoil and any other features which the subgrade supports.

The subgrade shall be prepared so as to ensure uniform support for the pavement structure. The finished subgrade shall be placed to within 1 inch below and $\frac{3}{4}$ inch above plan grade. Variations within this tolerance shall be gradual.

The subgrade shall be compacted to a minimum of 95% of its maximum unit weight, as measured by the AASHTO T-180 method, to a depth of 10 inches. If this cannot be achieved, in the opinion of the Engineer, he/she will direct the Contractor to perform "Subgrade Undercutting, Type ___" or "Subgrade Manipulation" as described herein.

The Contractor shall use equipment and methods of construction best suited, in the opinion of the Engineer, to the earthwork operations being performed and the project requirements. The use of various equipment and methods of construction are subject to the approval of the Engineer. The Engineer may disallow the use of certain equipment and methods of construction and require the use of other equipment and/or methods of construction. No additional compensation or extensions of contract time will be allowed for additional measures that are required for the protection of the grade as specified herein.

13. Test Rolling - The Contractor shall test-roll the foundation and/or subgrade with a pneumatic tired roller with a suitable body for ballast loading and a gross load capacity that can be varied from 25 and 40 tons. In lieu of this test roller, with the approval of the Engineer, the Contractor may use a fully loaded single axle or tandem axle dump truck.

14. Subgrade Undercutting - "Subgrade Undercutting" shall be performed on the foundation or subgrade in accordance with section 205.03.E (Subgrade Undercutting) of the MDOT 2012 Standard Specifications for Construction, as shown on the plans, as specified herein, and as directed by the Engineer.

15. Subgrade Manipulation - "Subgrade Manipulation" shall be performed on the foundation or subgrade in accordance with section 205.03.F (Subgrade Manipulation) of the MDOT 2012 Standard Specifications for Construction, as shown on the plans, as specified herein, and as directed by the Engineer.

Where subgrade manipulation is required, the foundation or subgrade shall be thoroughly scarified, blended, and mixed to a depth of 12 inches. The work shall be accomplished by means of a large diameter disc, motor grader, or other equipment approved by the Engineer. After the foundation or subgrade has been manipulated to the satisfaction of the Engineer and allowed to dry, the soil shall be compacted to 95% of its maximum dry density as measured by the AASHTO T-180 method. The time required for drying the soil will not be a basis for an extension of time.

The cost of Subgrade Manipulation shall be included in the cost of "Machine Grading, Special" unless a pay item for "Subgrade Manipulation" is included in the Proposal.

16. Rock Excavation - Rock excavation shall be performed in accordance with section 205.03.B (Rock Excavation) of the MDOT 2012 Standard Specifications for Construction, as shown on the plans, and as directed by the Engineer.

The pay item "Rock Excavation" will apply only to boulders over ½ cubic yard in volume. Boulders will be measured individually and the volume computed from the average dimension measured in three directions. The removal of rocks, concrete and masonry less than ½ cubic yard in volume shall not be included in the pay item "Rock Excavation," but shall be included in the pay item "Machine Grading, Special."

If the proposal does not include a pay item for "Rock Excavation," rocks measuring over ½ cubic yard in volume shall be paid for as extra work.

17. Lowering Structures - Prior to cutting the subgrade, the Contractor shall remove structure covers, lower the structures to a point between 8 inches and 12 inches below the proposed subgrade, and cover the structures with a steel plate. Structures shall not be raised prior to placing roadway embankment.

The steel plates for covering structure openings shall conform to the plan detail, be pegged and properly placed to prevent their movement under all traffic, be thick enough to carry all traffic, and prevent the infiltration of debris into the structures.

The Contractor shall lower valve boxes to a point between 8 inches and 12 inches below the proposed subgrade. Valve boxes shall not be raised prior to placing roadway embankment.

The void in the grade above the steel plates used for structure lowering and valve box lowering shall be backfilled, and compacted to 95% of its maximum dry density, with an Engineer approved coarse aggregate.

The Contractor shall coordinate the lowering of private utility structures with the private utility companies.

18. Structure Covers - As directed by the Engineer and within two days of their removal, the Contractor shall stockpile on-site, in a location that is mutually agreeable to the Engineer and Contractor, the existing structure covers. The City of Ann Arbor's forces will pick-up the structure covers at a time that is convenient to them and mutually agreeable to the Contractor. The Contractor shall provide the equipment and manpower to load the castings on the City's vehicle(s) so that they can be removed from the site by the City.

19. Structure and Sewer Cleanliness - All sewers, and structures, including manholes, gate wells, valve boxes, inlet structures and curbs shall be protected from damage and contamination by debris and construction materials. Structures shall be maintained clean of construction debris and properly covered at all times during the construction. The Contractor shall immediately clean any structures and/or sewers that become contaminated with construction debris. The Contractor shall be responsible for all direct and indirect damages which are caused by sewers or structures which have been made unclean or have been damaged by the Contractor.

20. Contractor's Calculations - Existing and proposed cross sections are provided in the plans. The Contractor shall perform his/her own computations and is responsible to inspect the site to determine his/her own estimate of the quantities of work involved. Deviations between the existing contours and the existing and proposed cross-sections shown on the plans shall not be cause for additional compensation.

21. Estimated Earthwork Quantities - The table shown below contains the Engineer's estimate of the earth excavation (cut), the embankment (fill), and topsoil stripping required to prepare the foundation as defined herein for the project. These quantities do not take into consideration the suitability of the soils for their intended use, their possible availability due to construction staging or storage limitations, bulking of the material upon excavation, changes in volumes due to moisture content or soil types, or other similar related issues. The Contractor shall remain responsible for determining the actual amount(s) of work to be performed to complete the project as shown on the plans and as specified herein.

Machine Grading Special Item of Work	Est. volume of earth excavation (cut), cubic yards	Est. volume of embankment (fill), cubic yards	*Topsoil and/or sub-soil to be stripped and removed, cubic yards

*The estimated volume for topsoil and/or sub-soil stripping has been estimated based upon the assumption that approximately 6" of topsoil and other deleterious soils exist that must be removed prior to exposing suitable soils for road building or other similar purposes. The estimated thickness can, and will, vary throughout the project limits.

22. Tree trimming - The Contractor shall coordinate with the City Field Services Unit to schedule trimming of trees by City forces or authorized subcontractor. The Contractor shall not be entitled to an extension of time or any additional compensation for the coordination of this work.

d. Measurement and Payment. The completed work, as described, will be measured and paid for at the contract unit price for the following pay item:

<u>Pay Item</u>	<u>Pay Unit</u>
Machine Grading, Special	Square Yard

Measurement for payment for the item **Machine Grading, Special** shall be the computed in square yard quantity of excavated material (pavement, soil, rock, brick, etc.) from the top of existing grade down to the bottom of the excavation. Embankment, fill, subgrade protection/maintenance, drainage maintenance, topsoil, seeding, and restoration quantities will not be paid for separately, and are included in this item of work.

Machine Grading, Special will be measured in area of the feature being constructed by the unit square yard, and include all labor, materials and equipment required to complete the work.

The Contractor shall include all of its costs to complete all of the work in the **Machine Grading, Special** pay item and plan quantities included in the proposal. No additional payment will be made for this work, which is shown on the plans and specified herein as work which needs to be completed, and may not be described as included in the pay item. Plan quantities will be paid for the work, and will only be adjusted due to changes in the limits of the work, as directed by the Engineer, in writing.

The pay item **Machine Grading, Special** shall include all the work specified herein, including, but not limited to, the removal and offsite disposal of any surplus or unsuitable materials and the furnishing from off-site any additional Engineer approved fill materials necessary to construct the embankment and subgrade to the contours and cross-sections shown on the plans.

The Contractor is advised that due to the phasing of the project and the probable unsuitability of some or all of the excavated material for use as approved fill material, there may be imbalances between the amount of earth cut which is suitable for reuse as fill, and the amount of earth needed to construct the lines and grades shown on the plans, or as directed by the Engineer. The Contractor shall make provisions for such imbalances and shall include in the bid price for this work the cost of importing/furnishing, placement, and compaction of the material, as well as the cost of stockpiling and re-handling of imported and/or on-site Engineer approved materials as necessary to complete the work of constructing the embankment and subgrade to the cross sections shown on the plans.

Subgrade Manipulation will be measured in square yards. Only areas designated by the Engineer as requiring subgrade manipulation will be measured for payment.

CITY OF ANN ARBOR
DETAILED SPECIFICATION
FOR
SUBGRADE UNDERCUTTING

AA:DAD

1 of 1

02/23/16

a. Description. This work shall include the removal of unsuitable subgrade material(s) which may be susceptible to frost heaving or differential frost action in the areas and limits identified by the Engineer, and backfilling to replace these material(s) and remedy unstable soil conditions. This work shall be done in accordance with section 205 of the Michigan Department of Transportation (MDOT) 2012 Standard Specifications for Construction, as directed by the Engineer, and as modified herein.

b. Materials. Provide materials in accordance with Granular Material Class II and 21AA dense-graded aggregate as specified in section 902 of the MDOT 2012 Standard Specifications for Construction.

c. Construction. Construction methods shall be as described in subsection 205.03.E of the Standard Specifications for Construction, and as directed by the Engineer.

After the pavement has been removed, and/or after rough/finish grading, and/or at the time of proof rolling, the Engineer may inspect the grade to determine the need for, and the limits of, undercuts. After undercut areas are excavated to the depths as directed by the Engineer, the areas shall be trimmed, shaped, evenly graded and re-compacted to not less than 95% of the soils maximum unit weight as determined by the AASHTO T-180 test. The Contractor shall properly dispose of all excess materials.

Backfill areas of Subgrade Undercutting, Type IIA with 21AA dense-graded aggregate, and areas of Subgrade Undercutting, Type IIB with Granular Material Class II, as directed by the Engineer.

d. Measurement and Payment. The completed work, as described, will be measured and paid for at the contract unit price for the following pay item:

<u>Pay Item</u>	<u>Pay Unit</u>
Subgrade Undercutting, Type IIA	Cyd
Subgrade Undercutting, Type IIB	Cyd

Basis of payment shall be as described in subsection 205.04 of the Standard Specifications for Construction.

CITY OF ANN ARBOR
 DETAILED SPECIFICATION
 FOR
SIDEWALK, SIDEWALK RAMP, AND DRIVEWAY APPROACH GRADING

AA:DAD

1 of 1

02/23/16

a. Description. Remove miscellaneous structures and materials and complete all earthwork required to construct the proposed cross sections within the limits shown on the plans or stated in this special provision. All lines and grades will be as shown on the plans and as directed by the Engineer. Complete this work according to the Standard Specifications for Construction, this special provision, and as directed by the Engineer.

b. Materials. Furnish and place required base and embankment materials conforming to the Standard Specifications for Construction as necessary to achieve the required typical cross sections. Excavated material, if suitable, may be used as embankment material as approved by the Engineer.

c. Construction. Complete this work according to applicable sections of the Standard Specifications for Construction. Grading for sidewalks, sidewalk ramp, and driveway approaches includes, but is not limited to, the following work:

1. Stripping and stockpiling topsoil for use in turf establishment as approved.
2. Sawcutting existing pavements and curbs.
3. Removing rocks or boulders less than 0.5 cubic yards in volume.
4. Excavating material to a depth necessary for construction.
5. Disposing of excess and unsuitable material according to Section 205.
6. Furnishing and placing embankment material to the grades necessary for construction.
7. Shaping, grading, and compacting the subgrade and embankment to proposed grades.
8. Furnishing and placing Granular Material, CI II base/bedding material to the required thickness.
9. Shaping, grading, and compacting base/bedding material to proposed grades.
10. Matching new sidewalk, sidewalk ramp, and driveway approach grades with existing grades as required.

d. Measurement and Payment. The completed work, as described, will be measured and paid for at the contract unit prices using the following pay items:

<u>Pay Item</u>	<u>Pay Unit</u>
Grading, Driveway Approach	Square Yard
Grading, Sidewalk	Square Yard
Grading, Sidewalk Ramp	Square Yard

The above items will be measured in area by the unit square yard and will be paid for at their respective contract unit prices, which prices shall be payment in full for all labor, equipment and material needed to accomplish this work.

CITY OF ANN ARBOR
SPECIAL PROVISION
FOR
SOIL EROSION AND SEDIMENTATION CONTROL – INLET FILTER

AA:DAD

1 of 1

04/05/15

a. Description. This work consists of installing and maintaining inlet filters, as shown on the plans, in accordance with Section 208 of the Michigan Department of Transportation (MDOT) 2012 Standard Specifications for Construction and. Filters shall be installed in existing and proposed inlets in order to minimize the erosion of soil and the sedimentation of water courses. The related work includes the installation, maintenance and removal of the filter cloth, cleaning as required during the performance of the project work, removing and disposing of accumulated sediment, and replacement of filters if required by the Engineer so as to provide a properly working inlet filter and a well-drained site.

b. Materials. The inlet filters shall be in accordance with the REGULAR FLOW SILTSACK® manufactured by ACF Environmental (800) 448-3636; FLEXSTORM® Style FX manufactured by Advanced Drainage Systems, Inc. (800) 821-6710; CATCH-ALL® manufactured by Price & Company (866) 960-4300, or Engineer approved equal.

The Contractor shall submit product data sheets and a sample of the filter material for inlet filters for Engineer approval prior to ordering materials.

c. Methods of Construction. The Contractor shall install, maintain, clean, and re-install and/or replace inlet filters in accordance with the manufacturer’s specifications and as directed by the Engineer. The Contractor shall dispose of debris off-site.

d. Measurement and Payment. The completed work, as described, will be measured and paid for at the contract unit price for the following pay item:

<u>Pay Item</u>	<u>Pay Unit</u>
Erosion Control, Inlet Filter	Each

Erosion Control, Inlet Filter will be measured by the unit installed and will be paid for at the contract unit price per each, for which price shall be payment in full for all labor, equipment, and materials needed to furnish, install, maintain, clean and remove the inlet filter, and re-install and/or replace the inlet filter as needed.

**DETAILED SPECIFICATION
FOR
STRUCTURE COVERS**

DESCRIPTION

This work shall consist of replacing and furnishing structure covers and castings for structures, gate wells and inlet structures as shown on the Plans and as directed by the Engineer, in accordance with Section 403 of the 2012 edition of the MDOT Standard Specifications for Construction, and the City Standard Specifications, except as specified herein.

MATERIALS

Materials shall meet the requirements of sections 701, 702, and 908 of the 2012 MDOT Standard Specifications, except that concrete shall be MDOT HE, 8.4-sack per Section 601.

All covers and/or castings shall conform to the model(s) specified, as follows:

<u>Type of Casting</u>	<u>MDOT Designation</u>	<u>NEENAH No. (Weight, Lbs)</u>	<u>EJIW No. (Weight, Lbs)</u>
Flat Inlet Structure Cover	D		5000/Type M2 Sinusoidal Grate (275 lbs.)
Manhole Flange and Cover	B	R-1642 w/ Type C cover Type D cover (380 lbs.)	1040 w/ Type A cover Type M1 (300 lbs.)
Curb Inlet or Catch Basin	K	R-3249F (410 lbs.)	7045 (500 lbs.)

All storm sewer covers shall have the lettering "DUMP NO WASTE!" and a fish image. All other covers shall have "SEWER" or "W" cast in the surface, whichever is applicable.

Frames and covers shall have machined bearing surfaces. Covers shall have two, 1-inch vent holes located opposite each other and 6-inches from the edge.

Castings and covers for monument and water-valve boxes will be provided by the City. The Contractor shall transport these new castings and covers to the site from the City Utilities Department yard at 4251 Stone School Road (Wheeler Center).

CONSTRUCTION METHODS

Materials shall be stored by the Contractor at locations arranged by the Contractor, subject to the approval of the Engineer. The Contractor shall not store materials or equipment, including metal castings and steel plates, on any lawn area.

The Contractor shall deliver all salvaged covers and castings to the Wheeler Center within two days of their removal.

MEASUREMENT AND PAYMENT

Payment for transporting new and salvaged castings and covers to and from the Wheeler Center is included in the appropriate items of work.

Completed work as measured for these items of work will be paid for at Contract Unit Price for the following Contract (Pay) Items:

<u>PAY ITEM</u>	<u>PAY UNIT</u>
Flat Inlet Structure Cover	Each
Manhole Flange & Cover (MDOT Type B)	Each
Inlet Structure Cover (MDOT Type K)	Each

The unit prices for these items of work shall include all labor, material, and equipment costs to perform all the work specified in the Standard Specifications and as modified by this Detailed Specification.

CITY OF ANN ARBOR
SPECIAL PROVISION
FOR
ADJUSTING STRUCTURE COVERS

AA:DAD

1 of 2

02/23/16

a. Description. This work shall include the final adjustment of all drainage and utility structure covers in accordance with section 403 of the Michigan Department of Transportation (MDOT) 2012 Standard Specifications for Construction, as shown on the plans, and as specified herein. Utility structures comprise gate valve wells/manholes, sanitary sewer manholes, gate valve boxes, monument boxes, and electrical/traffic signal handholes.

The Contractor shall also be required to coordinate the adjustment of private utility structure covers and ensure that the adjustment has been properly performed with the respective utility prior to placing any final paving materials.

b. Materials. In bituminous pavement areas, adjustments shall be made using MDOT P-NC concrete (658 lbs/cyd) as specified in section 601 of the MDOT 2012 Standard Specifications for Construction. In areas of concrete pavement, adjustments shall be made at the time of paving and encased with the grade of concrete used in the roadway.

c. Construction. Structure Covers, monument boxes, water valve boxes and all other public utility underground access or control point covers shall be adjusted to conform to the finished surface section and elevation. The adjusting of castings in lawn areas shall be performed in a one-step process. The adjusting of castings in a bituminous pavement area shall be performed in two steps: step one is the lowering of the structure cover to below the subgrade elevation and plating of the structure; step two is the final adjustment to finish grade made prior to placing the bituminous wearing surface. In areas of concrete pavement, the final adjustment of the structure to finish grade shall be made at the time of concrete pavement forming. All structures in areas of concrete pavement shall be approved by the Engineer prior to the placement of any concrete pavement.

All structures final adjustment is to be to the elevation which results in their top surface being flush with the finished grade. The work is to be accomplished and checked by using a 10 foot straight edge that is placed parallel, and then perpendicular to, the pavement centerline. Failure to meet these conditions will result in the readjustment of the structure and finish patching of the area, as directed by the Engineer, at the Contractor's expense.

All private utility manholes and valve covers (Electric, Gas, Telecommunications, etc.) will be adjusted during this project by the Utility. It is the responsibility of the Contractor to coordinate with these private utilities by giving adequate notice and arranging for any adjustment of structures or valves by these utilities. It shall be the sole responsibility of the Contractor to ensure that this work is completed in a timely manner.

The Contractor shall replace all existing structures covers, top portions of valve boxes and monument boxes.

As directed by the Engineer and within two days of their removal, the Contractor shall stockpile on-site, in a location that is mutually agreeable to the Engineer and Contractor, the existing structure covers. The City of Ann Arbor's forces will pick-up the structure covers at a time that is convenient to them and mutually agreeable to the Contractor. The Contractor shall provide

the equipment and manpower to load the castings on the City's vehicle(s) so that they can be removed from the site by the City.

All adjustments in areas of proposed bituminous pavement shall be backfilled with Grade P-NC concrete, from the depth of excavation necessary for adjustment, to an elevation 2 inches below the top flange or adjusted casting. This material shall be included in this item of work and will not be paid for separately.

Structure covers shall be adjusted to between flush and ¼ inch below final pavement surfaces.

d. Measurement and Payment. The completed work, as described, will be measured and paid for at the contract unit price for the following pay item:

<u>Pay Item</u>	<u>Pay Unit</u>
Dr Structure Cover, Adj, Case 1, Modified.....	Each
Dr Structure Cover, Adj, Case 2, Modified.....	Each

Dr Structure Cover, Adj, Case 1, Modified and Dr Structure Cover, Adj, Case 2, Modified will be measured and paid for at the contract unit price for each structure that is adjusted, which price shall be payment in full for all labor, equipment and material needed to accomplish this work.

Where the required adjustment of a structure is more than 6 inches above/below the proposed finished grade of the structure, it will be measured and paid for as " Dr Structure Cover, Adj, Add Depth, Modified". This shall also cover the repair of manholes and structures where less than the substantial rebuilding of the structure, as determined by the Engineer, is required.

There is a possibility that the Contractor may find hidden utility structures during the work. It is the Contractor's responsibility to inform the respective utility owner(s) of the findings. In such instances, the City may direct the Contractor to adjust the structure(s) to grade. This work will be paid as either Dr Structure Cover, Adj, Case 1, Modified or Dr Structure Cover, Adj, Case 2, Modified depending on the location of the hidden structure(s).

Payment for adjusting for new drainage structures, new manholes, new valves-in-wells and new valves-in-boxes shall be included in the respective items and will not be paid for under this item. The work for adjusting these items, however, shall be performed in accordance with this detailed specification.

CITY OF ANN ARBOR
SPECIAL PROVISION
FOR
DRAINAGE STRUCTURES

PLYMOUTH/GREEN: JN/DAD

1 of 3

01/10

a. Description. This work shall be done in accordance with Sections 403 of the 2003 Michigan Department of Transportation Standard Specifications for Construction, except as herein provided:

b. Materials. Storm sewer drainage structures shall be constructed of precast or cast in place reinforced concrete sections, or concrete masonry units.

Precast reinforced concrete bases, bottom sections, manhole risers, grade adjustment rings, concentric cones, eccentric cones, and flat slab tops shall conform to the requirements of ASTM C 478. Joints on precast manholes used on all sanitary sewers shall meet ASTM C 443, rubber O-ring gasket.

Precast manhole tees and radius pipe sections shall conform to requirements for reinforced concrete pipe, ASTM C 76, Class IV. Joints shall conform to adjacent pipe. Tees and radius pipe shall conform to details indicated on drawings offered by the Concrete Pipe Association of Michigan, Inc., or Engineer approved equal.

Concrete masonry units shall conform to the requirements for concrete masonry units for catch basins and manholes, ASTM C 139.

Concrete brick shall conform to the requirements for concrete building brick, ASTM C 55, Grade N-1.

Plastic coated manhole steps shall be injection molded of copolymer, polypropylene, encapsulating a 1/2 inch grade 60 steel reinforcing bar. Plastic-coated manhole steps shall meet the performance test described in ASTM C-478, Paragraph II, and shall have an impact resistance of 300 ft.-lbs., with only minor deflection and no cracking or breaking.

The steps shall resist pull out forces of 1500 lbs.

Sewer pipe to precast manhole connections shall be through: 1) a flexible neoprene rubber boot which shall be securely clamped into a core-drilled pipe port. Pipe ports shall be core-drilled at the point of manhole manufacture and shall be accurately located within 1/2-inch of proposed sewer centerline; or, 2) a self-adjusting mechanical pipe to manhole seal which provides a resilient flexible and infiltration-proof joint (Res-seal); or, 3) a flexible rubber wedge firmly rammed into a rubber gasket which is cast into the manhole (Press Wedge II), or equal approved in writing by the Public Services Director.

Neoprene rubber for manhole boots shall meet the requirements of ASTM C443 and shall have a minimum thickness of 3/8-inch. Pipe clamp bands shall be of corrosion-resistant steel.

CITY OF ANN ARBOR
SPECIAL PROVISION
FOR
DRAINAGE STRUCTURES

PLYMOUTH/GREEN: JN/DAD

2 of 3

01/10

c. Construction. Construction shall be in accordance with Section 403 of the Michigan Department of Transportation 2003 Standard Specifications for Construction.

Excavation shall be carried to the depth and width required to permit the construction of the required base. The excavation width shall be greater than the base. The bottom of the excavation shall be trimmed to a uniform horizontal bed and be completely dewatered before any concrete is placed therein. Concrete shall be Class A. Precast manhole bases and precast bottom sections are allowed.

Precast concrete manholes, inlets, gate wells and concrete special structures shall be constructed of Class A concrete in accordance with the Standard Detail Drawings and conform to the requirements of these Specifications.

Concrete block construction shall only be allowed for storm sewer manholes and inlets and shall be built of the size and dimensions shown on the Plans. The block shall be clean, laid in a full bed of mortar, and thoroughly bonded by completely filling the vertical end grooves with mortar so as to interlock with the adjacent block. The mortar beds and joints shall not exceed 3/4 inch thickness. The vertical joints are to be completely filled with the joints on the inside face rubbed full of mortar and struck smooth as the manhole, inlet or structure is built up. The entire outside face of the structure shall receive a 1/2 inch thick mortar coat and struck smooth. All masonry materials, sand, and water shall be heated to over 50 ° F during freezing weather, and the completed work shall be covered and protected from damage by freezing.

Circular precast manhole sections shall be constructed in accordance with the Standard Detail Drawings. Manhole stack units shall be constructed on level poured-in-place bases, precast concrete bases, or precast concrete bottom sections.

Precast cone sections shall be constructed in accordance with the Standard Details. These units shall be eccentric for all manholes, precast or block. All structures shall be topped with a minimum of one and a maximum of three brick or precast adjustment ring courses.

Manholes, inlets, and structures shall be constructed within 2-1/2 inches of plumb.

Frames and cover castings shall be set in full mortar beds and pointed on the structure interior to a smooth, brushed finish. The covers shall be set flush with sidewalk, roadway pavement, or ground surfaces.

Sewer pipes shall extend into structures a minimum of 1/2 inch and a maximum of 3 inches.

d. Measurement and Payment. The completed work as described will be measured and paid for at the contract unit prices using the following contract items (pay items).

CITY OF ANN ARBOR
SPECIAL PROVISION
FOR
DRAINAGE STRUCTURES

PLYMOUTH/GREEN: JN/DAD

3 of 3

01/10

Contract Item (Pay Item)

Pay Unit

Dr Structure, 24 inch dia, Modified Each
Dr Structure, Double Inlet Each

Dr Structure, 24 inch dia, Modified and **Dr Structure, Double Inlet** will be measured in place respectively by the unit each and paid for respectively at the contract unit price per each, which price shall be payment in full for all labor, materials and equipment needed to accomplish this work.

CITY OF ANN ARBOR
DETAILED SPECIFICATION
FOR
SUBGRADE UNDERDRAIN

AA:DAD

1 of 2

04/05/15

a. Description. The work shall include installing 6-inch geotextile-wrapped perforated or slotted underdrain in accordance with attached detail, as shown on the plans, as described herein, and as directed by the Engineer.

b. Material. The materials shall meet the requirements specified in section 404 of the Michigan Department of Transportation (MDOT) 2012 Standard Specifications for Construction, and as specified herein:

Fine Aggregate, 2NS	902
Underdrain Pipe, Perforated or Slotted	909.07.B

Geotextile (Filter Fabric) - The geotextile fabric for encasing the pipe shall be an approved material such as nylon, polypropylene, fiberglass, or polyester and shall be either woven, heat bonded, knitted or of continuous fibers. The geotextile shall completely cover and be secured to the pipe. In an unstretched condition, knitted polyester fabrics shall weigh at least 3.0 ounces per square yard and all other geotextiles shall weigh at least 3.5 ounces per square yard. The fabric shall be strong and tough and have porosity such that the fabric will retain soil particles larger than 0.106 mm (No. 140 sieve) and shall pass aggregate particles finer than 0.025 mm. Geotextiles shall be stored and handled carefully and in accordance with the manufacturer's recommendations and shall not be exposed to heat or direct sunlight to such extent as to significantly affect its strength or toughness. Torn or punctured geotextiles shall not be used.

c. Construction Methods. Geotextile-wrapped underdrain for subgrade drainage shall be installed as shown on the plans and as specified in section 404 of the 2012 MDOT Standard Specifications for Construction, with the following exceptions and additions:

1. The trench shall be constructed to have a minimum width of 18 inches and the underdrain shall be installed at the line grade and depth as indicated on the plans. The contractor shall maintain line and grade by means of a laser. The Engineer will not set line, grade or provide staking.
2. The trench shall then be backfilled with 2NS Fine Aggregate compacted to 95% of its maximum unit weight. The first lift of backfill material shall be placed at a maximum thickness of 6 inches. The second and subsequent lifts, or portions thereof, shall be placed at a maximum thickness of 12 inches up to an elevation level with the bottom of the existing aggregate base course, or as directed by the Engineer.
3. Upgrade ends of the pipe shall be closed with suitable plugs to prevent entrance of any material. All couplings, tees and other fitting shall be manufactured and installed so as to prevent infiltration of any material. If during the course of construction, existing edge drains are encountered; their ends shall be plugged to the satisfaction of the Engineer such that material can not enter the pipe(s).

4. Downgrade ends of the pipe shall generally be tapped into existing or new drainage structures. However, it may be necessary to tap underdrain into either existing or new storm sewer, or into existing or new inlet leads as directed by the Engineer.

5. The trench bottom and edge drain shall be constructed to the percent of grade indicated on the plans or as determined by the Engineer, with the minimum percent of grade being 0.5%. In addition, the underdrain shall be constructed to have a minimum cover, from top of pipe to finished pavement grade, of 36 inches.

6. During the construction of underdrain runs, it may be necessary to terminate construction due to conflicts with buried obstructions or at such time when the minimum cover is reached. The Engineer will review conflicts on a case by case basis and make a decision on whether to continue installing pipe or terminate runs prematurely. The Contract unit price will not be adjusted or additional payments made, for changes in the contract quantity due to Engineer ordered field changes associated when buried obstructions are encountered.

d. Measurement and Payment. The completed work, as described, will be measured and paid for at the contract unit price for the following pay item:

<u>Pay Item</u>	<u>Pay Unit</u>
Underdrain, Subgrade, 6 inch, Special	Foot

Underdrain, Subgrade, 6 inch, Special, will be measured in length by feet and will be paid for at the contract unit price, which price shall be payment in full for all labor, equipment and material needed to accomplish this work.

The unit price shall include the cost of the 6-inch perforated or slotted pipe, geotextile wrap, pipe fittings and/or plugs, 2NS granular bedding material, compaction and trench backfill, taps to new and existing drainage structures and storm sewers or inlet leads, all excavation, final trimming required to meet the dimensions of the typical and specific cross-sections, and the disposal of all surplus excavated materials.

**DETAILED SPECIFICATION
FOR
REMOVE HMA PAVEMENT AROUND CASTING**

DESCRIPTION

This work shall consist of removing HMA from around existing (not lowered) castings during the milling operation. This work shall be as described in Section 204 of the 2012 edition of the MDOT Standard Specifications for Construction, current supplemental MDOT specifications, and the City of Ann Arbor Standard Specifications, except as modified herein, and as directed by the Engineer.

This item does not apply to streets where structures have been lowered ahead of the milling.

CONSTRUCTION METHOD

The Contractor shall remove HMA surfaces to the same depth as the associated milling on the street without the removal of the aggregate or concrete base, all as shown on the Plans, as marked in the field, and as directed by the Engineer.

Removal of HMA of any thickness from around existing castings, including but not limited to manholes, valves, and monument boxes, shall be done by mill, mini-mill, hand work and/or other means as approved by the Engineer. Repair or replacement of any castings damaged during the milling/removal operation shall be the sole responsibility of the Contractor.

MEASUREMENT AND PAYMENT

The number of castings within the milling limits shall constitute the final amount. Measurement shall take place with both the Engineer and the Contractor (or their agents) present.

The completed work as measured for these items of work will be paid at the Contract Unit Prices for the following Contract (Pay) Item:

<u>PAY ITEM</u>	<u>PAY UNIT</u>
Remove HMA Pavement Around Structure	Each

The unit prices for these items of work shall include all labor, material, and equipment costs to perform all the work specified in the Standard Specifications and as modified by this Detailed Specification.

CITY OF ANN ARBOR
 DETAILED SPECIFICATION
 FOR
HMA APPLICATION ESTIMATE

AA:DAD

1 of 1

02/23/16

a. Description. The work shall be performed in accordance with the requirements of Division 5 of the Michigan Department of Transportation (MDOT) 2012 Standard Specifications for Construction, and as herein specified.

b. Materials.

PAY ITEM	HMA MIX	APPLICATION RATE	ESTIMATED THICKNESS	PERFORMANCE GRADE	AWI (min)
HMA, 5E3 HMA, 4E3	5E3 (top) 4E3 (leveling)	165 lb/syd 220 lb/syd	1.50 inches 2.00 inches	PG 64-28 PG 64-28	260 N/A
HMA, LVSP HMA, LVSP	LVSP (top) LVSP (leveling)	220 lb/syd 220 lb/syd	2.00 inches 2.00 inches	PG 58-28 PG 58-28	220 N/A
HMA, Approach	5E3 (Major Streets) LVSP (Local Streets)	220 lb/syd	Thickness may vary with maximum layer = 2.0 inches	PG 64-28 PG 58-28	260 220
HMA, Wedging, 36A	36A	Yield may vary between 110 and 330 lb/syd	Thickness may vary between 1.0 and 3.0 inches	PG 58-28	220
Hand Patching	5E3 (Major Streets) LVSP (Local Streets)	Yield may vary with maximum = 330 lb/syd	Thickness may vary with maximum layer = 3.0 inches	PG 64-28 PG 58-28	N/A

The Performance Grade asphalt binder range for the HMA mixture shall be as noted above. The Bond Coat material shall be applied in accordance with the requirements of the Detailed Specification entitled "HMA Paving". The uniform rate of application shall be a minimum of 0.10 gallons per square yard, and be approved by the Engineer. This work will not be paid for separately, but shall be included in the cost of the HMA pay items.

c. Measurement and Payment. The work shall be measured and paid for as provided elsewhere in the contract documents.

CITY OF ANN ARBOR
DETAILED SPECIFICATION
FOR
HMA PAVING

AA:DAD

1 of 3

04/09/15

a. Description. Hot Mix Asphalt (HMA) pavement base, leveling, and top courses shall be constructed in accordance with section 501 of the Michigan Department of Transportation (MDOT) 2012 Standard Specifications for Construction, except as modified herein, and as directed by the Engineer.

b. Materials. None specified.

c. Construction Methods.

1. Equipment: All equipment shall conform to subsection 501.03.A of the MDOT 2012 Standard Specifications for Construction, except as modified herein.

The Contractor shall have a 10 foot long straight edge, rubber-tired backhoe (Case 580 type, or equivalent), air-compressor with the ability to develop a minimum pressure of 100 pounds per square inch and continuous rated capacity of 150 cubic feet per minute of air flow, and jackhammer available during all paving operations. The Contractor shall be required to perform any miscellaneous cleaning, trimming, material removal, and other tasks as required by the Engineer in order to ensure the proper and orderly placement of all HMA materials on this project.

The Contractor shall provide sufficient rollers to achieve the specified asphalt densities.

At various times throughout the work, the Engineer may direct the Contractor to use smaller and/or lighter equipment, and to defer certain work tasks, in order to protect the grade and/or adjacent areas; including hauling units. The Contractor shall not be entitled to any additional compensation for the use of smaller equipment, lighter equipment, or work task deferral.

2. Cleaning and Bond Coat Application: Cleaning and bond coat application shall be performed in accordance with subsections 501.03.C and 501.03.D of the MDOT 2012 Standard Specifications for Construction, except as modified herein, and as directed by the Engineer.

The Contractor shall furnish and operate throughout the construction period, vacuum-type street cleaning and utility structure cleaning equipment (Vac-All, Vector, etc.) approved by the Engineer, and when directed by the Engineer, for street cleaning immediately prior to, and for street and utility structure cleaning after any and all paving. The cleaning equipment shall be of sufficient power to remove dust, dirt, and debris from the pavement and from utility structures in and adjacent to the construction area. The vac-all or similar equipment and shall be approved by the Engineer prior to beginning the work. The equipment used shall have an effective means for preventing any dust resulting from the operation from escaping into the air.

The bond coat shall be applied at a rate of 0.10 gallons per square yard. Before placing the bond coat, the existing pavement surface shall be thoroughly cleaned. The Contractor shall also thoroughly clean all joints, cracks, and edges to a minimum depth of one inch with compressed air, vac-all type equipment, or other approved mechanical or hand methods, to remove all dirt, debris, and all foreign material.

3. HMA Placement: Placement shall conform to subsection 501.03.F of the MDOT 2012 Standard Specifications for Construction, except as modified herein, and as directed by the Engineer.

HMA placement shall not commence until a "Permit to Place" (no additional costs are required to obtain this permit) has been issued in writing by the Engineer. The Permit to Place shall be issued after the aggregate base course or the adjacent, underlying layer of pavement section has been approved by the Engineer.

The final structure adjustments must be approved by the Engineer prior to the issuance of the "Permit to Place" for the top course.

The top course shall be placed with a ¼" lip at the gutter edge of metal.

All HMA thickness dimensions are compacted-in-place.

4. Paving Operation Scheduling: The Contractor shall schedule the paving operation to avoid longitudinal cold joints that would be required to be left "open" over night.

In all cases, the Contractor shall pave the primary road's through-traffic lanes ("main line") first, from point-of-beginning to the point-of-ending. All other paving including, but not limited to; acceleration and deceleration lanes, intersection approaches, and center left-turn lanes shall be paved following completion of main line paving, unless authorized by the Engineer prior to the placement of any pavement.

5. Rate of Paver Operation: The rate of the paver's travel shall be maintained such that the paving operation will be continuous; resulting in no transverse cold joints, but shall never exceed the rate of 50 feet per minute.

The Contractor shall furnish and operate enough material, equipment, and hauling units so as to keep the paving machine(s) moving continuously at all times. Failure to do so shall be cause for the suspension of the paving operation until the Contractor can demonstrate to the satisfaction of the Engineer, that sufficient resources have been dedicated to perform the work in accordance with the project specifications.

6. Longitudinal and Transverse Joints: These joints shall conform to subsection 502.03.F of the MDOT 2012 Standard Specifications for Construction, and as specified herein.

For mainline HMA paving, the width of the mat for each pass of the paver shall be not less than 10.5 feet, or greater than 15 feet, except as noted in the plans and as directed by the Engineer. The Engineer will direct the layout of all HMA longitudinal joints during construction.

7. Feather Joints – shall be constructed so as to vary the thickness of the HMA from zero inches to the required paving thickness at the rate of approximately 1.5” over a distance of 10 feet, or as directed by the Engineer. The Contractor shall rake the larger pieces of aggregate out of feather joints prior to compaction.

8. Butt Joints: Construction of butt joints, where directed by the Engineer, shall conform to subsections 501.03.C.3 and 501.03.C.4 of the MDOT 2012 Standard Specifications for Construction, except as modified herein.

When a butt joint is specified or directed to be placed by the Engineer, remove the existing HMA surface to the thickness of the proposed overlay, or full-depth, as directed by the Engineer, for the full width or length of the joint. The HMA material shall be sawcut to the directed depth along the pavement edge or removal line to prevent tearing of the pavement surface. Cut joints that will be exposed in the completed surface must be cut with a saw or a cold-milling machine or other methods approved by the Engineer. Joints that will be covered by HMA must be cut with a saw, a cold-milling machine, or other methods approved by the Engineer.

9. Rakers: The Contractor shall provide a minimum of two asphalt rakers during the placement of all wearing and leveling courses.

10. Faulty Mixtures: The Contractor and Engineer shall carefully observe the paving operation for signs of faulty mixtures. Points of weakness in the surface shall be removed or corrected by the Contractor, at his/her sole expense, prior to paving subsequent lifts of bituminous material. Such corrective action may include the removal and replacement of thin or contaminated sections of pavement, segregated HMA, and any sections that are weak or unstable. Once the Contractor or his representative is notified by the Engineer that the material being placed is out of allowable tolerances, or that there is a problem with the paving operation, the Contractor shall stop the paving operation at once, and shall not be permitted to continue placing bituminous material until again authorized by the Engineer. Any costs associated with meeting the requirements specified herein shall not be paid for separately, but shall be included in the item(s) of work being performed at the time the faulty mixture was discovered.

d. Measurement and Payment. Unused HMA remaining in trucks after the work is completed shall be returned to the plant and re-weighed, and the corrected weight slip shall be provided to the Engineer. No payment will be made for the unused HMA material. All weight slips must include the type of mixture (codes are not acceptable), as well as vehicle number, gross weight, tare weight and net weight.

All costs of meeting the requirements of this special provision shall be included in the bid prices for HMA items in the proposal and will not be paid for separately.

CITY OF ANN ARBOR
DETAILED SPECIFICATION
FOR
ACCEPTANCE OF HMA MIXTURES

AA:MGN
FHWA 01/14/14

1 of 4

01/14/14

a. Description. This special provision establishes acceptance criteria for HMA Mixtures on City of Ann Arbor projects. The HMA mixtures shall meet all the requirements of section 501 of the Michigan Department of Transportation (MDOT) 2012 Standard Specifications for Construction, except as modified herein.

b. Contractor Quality Control. The Contractor must have a quality control plan as required by subsection 501.03.M of the MDOT 2012 Standard Specifications for Construction, and as stipulated herein. The Quality Control (QC) Plan shall be submitted to the Engineer within 30 days of contract award or 14 days before the placement of any HMA materials, whichever date comes first. The QC Plan shall cover all aspects of HMA production, transportation, placement, and compaction. The Contractor shall have a QC representative on-site at all times during the paving operations to monitor and direct all paving-related operations. The placement of HMA shall not commence until such time as the QC Plan has been accepted by the Engineer. The Engineer's acceptance of the QC Plan shall not be construed as a basis of acceptance of any HMA materials, HMA placement results, or a waiver of any requirement(s) of the project specifications.

c. Materials. Aggregates, mineral filler (if required), and asphalt binder shall be combined as necessary to produce a mixture proportioned within the specification requirements including aggregate gradation; the mix design criteria including volumetric properties; the Superpave Gyrotory (SGC) compaction criteria; and the uniformity tolerances listed in Table 1. Topsoil, clay, or loam shall not be added to aggregates which are to be used in plant mixed HMA mixtures.

d. Mix Designs. The Contractor shall submit mix designs for evaluation in accordance with the Michigan Department of Transportation Hot Mix Asphalt Production Manual. All mix designs shall be submitted for review a minimum of 3 weeks prior to the anticipated placement of the HMA. The Contractor's production and paving schedules shall be considered to include the mix design review and approval process. Delays associated with the submittal, or re-submittal, of the required information shall not be a basis for an extension of contract time.

e. Construction. Target air voids shall be 4% in leveling courses, top courses and shoulders paved in the same operation as the leveling and top courses. Target air voids shall be 3% in base courses and shoulders not paved in the same operation as the leveling and top courses. Pedestrian paths shall have a target air void content of 3%.

After the job-mix-formula (JMF) is established, the parameters identified in Table 1 shall be maintained within the Range 1 tolerance limits of Table 1. If deviations are predominately below or above the JMF the Engineer may order alterations in the plant to bring the mixture into better conformance with the JMF.

Should the HMA furnished fail to meet the Range 1 acceptance criteria for any parameter, the Contractor shall suspend all operations. Contract time will continue during these times when the plant is down. Before resuming any production, the Contractor shall propose, for the Engineer's approval, all necessary alterations to the materials or plant so that the JMF can be maintained. The Engineer, after evaluating for effects on the AWI and mix design properties, will approve or disapprove such alterations.

Acceptance sampling and testing will be performed by the Engineer using the sampling method and testing option selected by the Engineer. Quality control measures to ensure job control are the responsibility of the Contractor.

The crushed particle content of the aggregate used in the HMA mixture shall not be more than 10 percentage points above or below the crushed particle content used in the JMF, nor less than the minimum specified for the aggregates in the contract documents.

Pavement density will be measured by the Engineer with a nuclear density gauge using the G_{mm} from the JMF for the density control target. The required in-place density of the HMA shall be between 92.0 and 96.0 percent of the density control target. The Contractor is responsible for establishing a rolling pattern that will achieve the required in-place density. Should the specified target densities not be met, the material shall be considered to have a Range 2 failure and shall be rejected. If the Engineer determines that the material is suitable to remain in place, a 50% reduction to the unit price of all material affected shall be enacted by the Engineer. Should the Engineer determine that the material cannot remain in place; the affected material will be removed and replaced at the Contractor's sole expense as detailed in the Section entitled "Price Adjustments".

Acceptance Criteria

Table 1 – Uniformity Tolerance Limits for HMA Mixtures

Parameter	Top and Leveling Courses		Base Course	
	*Range 1	Range 2	*Range 1	Range 2
Air Voids	± 0.60	± 1.00	± 0.60	± 1.00
VMA	± 0.60	± 1.00	± 0.60	± 1.00
G_{mm} (maximum specific gravity of mixture)	± 0.013	± 0.020	± 0.013	± 0.020
Fines to Effective Binder Ratio (this parameter is independent of JMF)	0.6 to 1.2	0.6 to 1.4	0.6 to 1.2	0.6 to 1.4
Binder Content	± 0.30	± 0.40	± 0.30	± 0.40
Percent Passing No. 8 and Larger Sieves	± 5.0	± 8.0	± 7.0	± 9.0
Percent Passing No. 30 Sieve	± 4.0	± 6.0	± 6.0	± 9.0
Percent Passing No. 200 Sieve	± 1.0	± 2.0	± 2.0	± 3.0
*This range allows for normal mixture and testing variations. The mixture shall be proportioned to test as closely as possible to the Job-Mix-Formula.				

The tolerances specified in Table 1, with the exception of the Fines to Effective Binder Ratio, reflect variations from the approved job-mix formula.

Extraction and volumetric tests will be performed by the Engineer to confirm conformance to the specifications and the tolerances identified in Table 1. The minimum number of field extractions to be performed shall be in accordance with Table 2. The Engineer may elect to perform a minimum of 3 extractions per mixture, per day, for quantities less than 1000 tons.

Table 2 – Minimum Number of Extractions

Quantity (tons) of Single Mixture Placed per Day	Minimum Number of Extractions per Mixture per Day
<250	0
250 - 1000	2
1000 - 1500	3
1500 - 2000	4
2000 - 2500	5
2500 - 3000	6

e. Rejected Mixtures. If more than one half the extractions and/or volumetric tests for a single mixture, batched on a single day, exceed the uniformity tolerance of Range 2 for any parameter in Table 1, or do not meet the minimum requirements for crushed particle content specified in the project documents, the mixture will be rejected.

If such mixtures are placed in a pavement, the remaining portions of the failing field samples (split samples) will be tested by an independent, accredited, private laboratory, the MDOT Region Laboratory, or the MDOT Central Laboratory (for the purposes of this contract, any of these laboratories can be considered a 3rd Party testing laboratory) to confirm the field test results. If necessary, to obtain additional HMA material, the Engineer will take pavement cores. The Contractor may only take cores if approved in writing by the Engineer. If the 3rd Party test results do not confirm the original field test results, then no price adjustments will be made for the mixture involved.

If the 3rd Party's test results confirm the original field test results and, if in the Engineer's judgment, the mixture warrants removal, the Contractor shall remove and replace the entire mixture placed on a given day, at the Contractor's expense, with a mixture meeting the specification requirements.

If the 3rd Party's test results confirm the original field test results and, if in the Engineer's judgment, the mixture can remain in place, the contract unit price for the entire mixture placed on a given day will be decreased as described in the Section entitled "Price Adjustments".

If no field extractions are performed on a given day because the quantity being placed is less than 250 tons, and if there is reason to believe that the mixture exceeds Range 2, or if the crushed particle content is less than the established criteria, based on test results from a different day, the price reduction may also be applied, or removal may be required, based on extraction tests performed by the Engineer from pavement cores.

f. Price Adjustments. If more than one half of the field extractions for a single mixture, batched on a single day, exceed the uniformity tolerance of Range 1, but not Range 2, for any parameter in Table 1, the contract unit price will be reduced by 10 percent. Field tests indicating that mixtures are subject to the 10 percent penalty will be confirmed by 3rd party testing as described in the Section entitled "Rejected Mixtures".

If more than one half of the field extractions for a single mixture, batched on a single day, meet or exceed the uniformity tolerance of Range 2 for any parameter in Table 1, the material shall be removed and replaced at the Contractor's sole expense. These costs shall be deemed to include all costs associated with the material removal and replacement including, but not limited to; costs associated with re-mobilization of labor and equipment; traffic control; removal and disposal of the rejected material; transportation costs to provide material meeting the requirements of the specification; and any other cost associated with the work. Contract time shall continue during the period of time that the rejected material is investigated and re-tested, as well as, during the removal and replacement operations.

If no field extractions are performed on a given day because the quantity being placed is less than 250 tons, and the Engineer believes that the mixture exceeds Range 1 tolerances based on test results from a different day, the price reduction may also be applied, or removal may be required, based on material tests performed by the Engineer's representative from pavement core(s).

The Contractor will be back-charged for additional testing performed by the Engineer associated with mixtures which are rejected or penalized.

**DETAILED SPECIFICATION
FOR
HMA WEDGING**

DESCRIPTION

This work shall consist of constructing HMA finish wedges at drive approaches, sidewalk ramps, and any other locations, in accordance with Section 501 of the 2012 edition of the MDOT Standard Specifications, current supplemental MDOT specifications, and the City of Ann Arbor Standard Specifications, except as modified herein, and as directed by the Engineer.

MATERIALS AND EQUIPMENT

The HMA mixture to be used for this work shall be MDOT No. 36A or an acceptable substitute approved by the Engineer.

CONSTRUCTION METHOD

The Contractor shall complete all finish wedging within two days of placement of the wearing course.

The Contractor shall have a 10-foot long straight-edge, backhoe, air-compressor and jackhammer available during all paving operations.

Finish wedges shall provide good vertical and horizontal transitions between old and new construction, shall eliminate areas of standing water in the wearing surface, and shall provide positive drainage.

The Contractor shall construct feather joints at the edges of all finish wedges (including the raking out of all large pieces of aggregate), so as to provide a high quality, smooth riding surface.

Prior to placement of wedging material, the surface shall be cleaned with compressed air and/or vacuum type street cleaning equipment.

All asphalt and concrete surfaces within the wedging area shall be covered with MDOT SS-1h bond coat, applied at a rate of 0.10 gallons/square yard. The bond coat shall be applied with a power distributor hand sprayer.

MEASUREMENT AND PAYMENT

Measurement shall be by the ton, in place. Unused portions of material loads shall be returned to the plant and re-weighed and the corrected weight slip shall be provided to the Engineer. All weight slips must include type of mixture delivered to the site (codes are not acceptable), as well as vehicle number, gross weight, tare weight and net weight.

The completed work as measured for these items of work will be paid for at the Contract Unit Prices for the following Contract (Pay) Items:

PAY ITEM

HMA Finish Wedging

PAY UNIT

Ton

The unit prices for these items of work shall include all labor, material, and equipment costs to perform all the work specified in the Standard Specifications and as modified by this Detailed Specification.

**DETAILED SPECIFICATION
FOR
SPEED HUMP (STANDARD)
RAISED INTERSECTION**

DESCRIPTION

This work shall consist of constructing traffic calming devices in accordance with this detailed specification, Division 5 of the 2012 edition of the MDOT Standard Specifications, current supplemental MDOT specifications, the City of Ann Arbor Standard Specifications, the project plans, and as directed by the Engineer. Refer to the Traffic Calming Details in the project plans for further details.

MATERIALS

The HMA mixtures to be used for this work shall be MDOT LVSP, 36A, or an acceptable substitute approved by the Engineer.

CONSTRUCTION METHODS

The Contractor shall provide a 10-foot long straight-edge and a 10-foot long level during all paving operations. Prior to placing HMA material, all areas shall be cleaned with compressed air, and/or vacuum type street cleaning equipment (Vac-all), to remove dirt and loose material. Compressed air shall be from a source which provides a minimum of 90 psi and 150 cubic feet per minute of air at the nozzle.

All asphalt and concrete surfaces within all patch areas shall be covered with MDOT SS-1h bond coat, applied at a rate of 0.05 gallons/square yard. The bond coat shall be applied with a power distributor hand sprayer. The Contractor shall use an asphalt paver or, where approved by the Engineer, the Contractor may place the material by hand directly. The Contractor shall not place HMA materials on adjacent pavement surfaces.

Traffic calming devices shall be constructed in two layers. Each layer of HMA mixture shall be compacted to between 92 and 96 percent (or as determined acceptable by the engineer) of the theoretical maximum density, as listed on the approved Job Mix Formula. Placement of permanent thermoplastic pavement markings in accordance with this Detailed Specification and the project plans shall be included in this item of work.

MEASUREMENT AND PAYMENT

The completed work as measured for these items of work will be paid for at the Contract Unit Prices for the following Contract (Pay) Items:

<u>PAY ITEM</u>	<u>PAY UNIT</u>
Speed Hump (Standard)	Square Yard
Raised Crosswalk	Square Yard
Raised Intersection	Square Yard

The unit prices for these items of work shall include all labor, material, and equipment costs to perform all work, including pavement markings, specified in the Standard Specifications and as modified and as shown on this Detailed Specification.

**DETAILED SPECIFICATION
FOR
ITEM #268 - FLOWABLE FILL**

DESCRIPTION

This work shall consist of furnishing and placing flowable fill as backfill material at miscellaneous locations as shown on the Plans, and as directed by the Engineer.

MATERIALS

Flowable fill shall meet the requirements of the City of Ann Arbor Standard Specifications.

CONSTRUCTION METHODS

The Contractor shall furnish and place flowable fill at miscellaneous locations as shown on the Plans and as directed by the Engineer.

MEASUREMENT AND PAYMENT

Flowable fill used at the Contractor's option will not be paid for separately, but shall be included either in the bid price(s) for the associated work item(s), or in the bid price for the item of work "General Conditions".

The completed work as measured for this item of work will be paid for at the Contract Unit Price for the following Contract (Pay) Item:

PAY ITEM

Flowable Fill

PAY UNIT

Cubic Yard

The unit price for this item of work shall include all labor, material, and equipment costs to perform all the work specified in the Standard Specifications and as modified by this Detailed Specification.

CITY OF ANN ARBOR
SPECIAL PROVISION
FOR
CONCRETE PLACEMENT AND PROTECTION

AA:DAD

1 of 2

04/06/15

a. Description. This work shall consist of furnishing all labor, material, and equipment needed to furnish, place, and protect all concrete material in accordance with the requirements of this special provision. These requirements shall not apply to concrete bridge decks, unless otherwise noted.

b. Materials. The concrete shall meet the requirements of sections 601 and 701 of the Michigan Department of Transportation (MDOT) 2012 Standard Specifications for Construction.

The Contractor shall propose specific concrete mix designs for the intended project purpose in accordance with the requirements of this special provision and other applicable special provisions and/or project requirements. The Engineer's acceptance of a mix design shall not relieve the Contractor of their responsibility for the manufacture of the concrete mixture(s), its placement, or performance.

c. Construction. The Contractor shall perform all concrete placement operations in weather that is suitable for the successful placement and curing of the concrete materials. Concrete shall not be placed during periods of active precipitation.

The Contractor shall complete all needed formwork, base and/or sub-base preparation, and any other related items that are deemed necessary for the proper completion of the work. The Contractor shall not commence the placement of concrete until they receive all needed approvals from the Engineer for placement. The Engineer's approval of the Contractor to place concrete shall not relieve the Contractor of their responsibility for the proper placement and protection of the concrete materials or its long-term performance.

During periods when precipitation is threatening, provide durable, plastic sheeting, approved by the Engineer, in sufficient quantity to cover and protect all freshly placed concrete such that precipitation does not come into contact with the concrete. The Contractor shall arrange the placement of the plastic sheeting such that the surface of any freshly placed concrete is not marred by contact with the plastic; any seams in the plastic sheeting shall be water tight. The Contractor shall place adequate supports along and over the freshly placed concrete to prevent contact of the plastic and concrete. The Contractor shall ensure that sufficient dams or barriers are placed along the edges of the freshly placed concrete to prevent erosion of the underlying materials or damage to the edges of the freshly placed concrete. All measures shall be effective.

Any concrete damaged by precipitation shall be removed and replaced at the Contractor's expense. The Engineer shall decide if the concrete has been damaged and the limits of removal and replacement.

Concrete shall only be placed when the rate of surface evaporation at the site is less than 0.20 pounds per square foot per hour, according to figure 706-1 of the MDOT 2012 Standard Specifications for Construction. The Contractor shall provide approved equipment for determining the relative humidity and wind velocity at the site.

Water shall not be added to the placed concrete in order to aid finishing. Any water added to the concrete for slump adjustments shall be done by adding water to the mixing unit and thoroughly re-mixing the concrete for 30 revolutions of the mixing unit at mixing speed. Water shall not be added such that the design water-to-cement ratio of the concrete mixture or the design slump of the concrete mix is exceeded.

Concrete curing shall be performed in accordance with subsection 602.03.M of the MDOT 2012 Standard Specifications for Construction. Curing operations shall take precedence over texturing operations and continued concrete placement. All curing compound applied shall provide uniform coverage over the entire surface being protected. The placement of curing compound shall be free of spots, blotches, or uncovered or non-uniformly covered areas. Should any areas be determined to exist by the Engineer, the curing compound shall be immediately re-applied by the Contractor at no additional cost to the project.

The Contractor shall take all precautions when placing concrete to protect it from damage due to the elements. Concrete shall not be placed during precipitation events.

Concrete shall be protected from weather and temperature according to the requirements of subsection 602.03.T MDOT 2012 Standard Specifications for Construction. Concrete shall not be placed when the temperature of the plastic concrete mixture itself is greater than 90° F. In conditions where low temperature protection is required, the Contractor shall cover the concrete with insulated blankets, or other means as approved by the Engineer, to protect the concrete from damage. The concrete shall remain protected until it has reached a compressive strength of at least 1000 psi, or as directed by the Engineer.

d. Measurement and Payment. All costs associated with the conformance to the requirements of this Special Provision will not be paid for separately, but shall be considered to be included in the respective items of work.

CITY OF ANN ARBOR
 DETAILED SPECIFICATION
 FOR
CONCRETE CURB AND GUTTER, AND DRIVEWAY OPENINGS

AA:DAD

1 of 2

04/06/15

a. Description. This work shall consist of constructing concrete curb and gutter, and concrete driveway openings in accordance with attached details, section 802 of the Michigan Department of Transportation (MDOT) 2012 Standard Specifications for Construction, as shown on the plans, and as specified herein.

b. Materials. The materials shall meet the requirements as specified in section 802 of the MDOT 2012 Standard Specifications for Construction and as specified herein:

The concrete mixture for Driveway Opening, Conc, Det M, Modified shall be Grade P-NC (658 lbs/cyd cement content) concrete with 6AA coarse aggregate.

All other concrete curb and gutter specified herein shall be Grade P1 with 6AA coarse aggregate. The Contractor may elect to add GGBFS to P1 mixtures in accordance with the requirements of the contract documents. No additional payment will be made for concrete mixtures containing GGBFS.

All concrete mixtures shall contain 6AA coarse aggregates which are either natural or limestone and meet the requirements of section 902 the MDOT 2012 Standard Specifications for Construction.

It shall be the Contractor's sole responsibility to propose specific concrete mix designs which meet the requirements of this Detailed Specification.

c. Construction. Construction methods shall be in accordance with section 802 of the MDOT 2012 Standard Specifications for Construction. Curb and Gutter, Conc shall be 2 feet wide barrier curb and gutter and constructed where shown in the plans.

Expansion joints of the thickness shown on the details shall be placed as directed by the Engineer.

d. Measurement and Payment. The completed work, as described, will be measured and paid for at the contract unit prices respectively for the following pay items:

<u>Pay Item</u>	<u>Pay Unit</u>
Curb and Gutter, Conc,.....	Foot
Driveway Opening, Conc, Det M, Modified,	Foot

The pay items will be measured in length by the foot and will be payment in full for all labor, equipment and material needed to properly complete this work.

At curb openings for sidewalk ramps, the concrete curb and gutter (without the curb face) will be measured and paid for at the contact unit price for curb and gutter.

Where the Engineer directs the use of high early strength concrete for pay items that are not specifically designated to use Grade P-NC concrete, the additional cement shall be paid for separately. No additional payment will be made for cement for pay items that are designated to use Grade "P-NC." concrete.

CITY OF ANN ARBOR
DETAILED SPECIFICATION
FOR
CONCRETE SIDEWALK, SIDEWALK RAMPS, AND DRIVEWAY APPROACHES

AA:DAD

1 of 2

02/23/16

a. Description. This work shall consist of constructing concrete sidewalks, sidewalk ramps, or driveway approaches of the types as indicated on the plans in accordance with attached details, and as directed by the Engineer. All work shall be in accordance with sections 801 and 803 of the Michigan Department of Transportation (MDOT) 2012 Standard Specifications for Construction, and as specified herein.

b. Materials. The materials shall meet the requirements as specified sections 801 and 803 of the MDOT 2012 Standard Specifications for Construction and as required herein. The concrete mixture for driveway approaches shall be Grade P-NC (658 lbs/yd³ cement content) as specified in section 601 of the MDOT 2012 Standard Specifications.

The grade of concrete for all remaining items covered by this Detailed Specification shall be Grade P1 as specified in section 601 of the 2012 MDOT Standard Specifications for Construction. The Contractor may elect to add GGBFS to P1 mixtures in accordance with the requirements of the contract documents. No additional payment will be made for concrete mixtures containing GGBFS.

All concrete mixtures shall contain 6AA coarse aggregates which are either natural or limestone and meet the requirements of section 902 of the MDOT 2012 Standard Specifications for Construction.

It shall be the Contractor's sole responsibility to propose specific concrete mix designs which meet the requirements of this Detailed Specification.

c. Construction Methods. The Contractor is responsible to construct all sidewalks, sidewalk ramps, curbs, and all other concrete items within ADAAG compliance. All sidewalk and curb ramps must be constructed in accordance with MDOT Standard Plan Series R-28.

Where concrete is to be placed, it shall be placed on a minimum of 4 inches of Granular Material Class II compacted to 95% of its maximum dry density.

Prior to placing any concrete, the subgrade shall be completed and trimmed to final elevation. If a cold joint is required, the existing concrete is to be cleaned with compressed air to expose the aggregate in the concrete.

Where indicated on the plans, the Contractor shall horizontally sawcut curbs to provide openings for sidewalk ramps. The Engineer shall define the extent of sawcutting both horizontally and vertically. This work will not be paid for separately, but shall be included in the corresponding price of the ADA ramp to be placed.

All sidewalk ramps shall be installed with detectable warning units. Reference the Detailed Specification entitled "Detectable Warning Surface" for additional requirements.

d. Measurement and Payment. The completed work, as described, will be measured and paid for at the contract unit prices respectively for the following pay items:

<u>Pay Item</u>	<u>Pay Unit</u>
Driveway, Nonreinf Conc, 6 inch, Modified	Square Yard
Driveway, Nonreinf Conc, 6 inch, Modified	Square Yard
Sidewalk, Conc, 4 inch, Modified	Square Foot
Sidewalk, Conc, 6 inch, Modified	Square Foot
Sidewalk Ramp, Conc, 6 inch, Modified	Square Foot

The above items will be measured by area in square feet and be paid for at their respective contract unit price, which price shall be payment in full for all labor, equipment and material needed to accomplish this work. The unit price shall also include all costs associated with sawcutting curbs to provide openings for sidewalk ramps as indicated on the plans.

Where the Engineer directs the use of high early strength concrete for pay items that are not specifically designated to use Grade "P-NC" concrete, the additional cement shall be paid for separately. No additional payment will be made for cement for pay items that are designated to use Grade "P-NC." concrete.

Excavation for placement of Granular Material Class II bedding material shall be included in the item of work **Machine Grading, Special**, and shall not be paid for separately.

Detectable warning units shall be paid for in accordance with the Detailed Specification for Detectable Warning Surface.

**DETAILED SPECIFICATION
FOR
INTEGRAL SIDEWALK RETAINING WALL (6" OR LESS)
INTEGRAL SIDEWALK RETAINING WALL (6"-18")**

DESCRIPTION

This work shall consist of constructing concrete retaining walls adjacent to sidewalks, in accordance with Sections 802 and 803 of the 2012 edition of the MDOT Standard Specifications for Construction, except as specified herein, as shown in this Detailed Specification, and as directed by the Engineer.

MATERIALS

Concrete mixtures shall be High Early, 8.4-sack concrete, or as directed by the Engineer, meeting the requirements specified in the appropriate sections of the MDOT Standard Specifications.

CONSTRUCTION METHODS

The Contractor shall construct the Item "Integral Sidewalk Retaining Wall (6" or less)" in accordance with MDOT standard plan R-30 for Detail E2 curb. Curb face exposure shall be 6 inches or less.

The Contractor shall construct the Item "Integral Sidewalk Retaining Wall (6"-18")" as shown on the following Detail.

All subgrade work shall be completed prior to placing concrete items, unless directed or approved by the Engineer.

The Contractor shall excavate, cut, remove stumps, remove brush, remove pavement, grade, and trim as needed and as directed, and shall import, furnish, fill, place, grade, and compact any materials needed to perform the work.

At locations where the subgrade, subbase or base becomes either disturbed, saturated or otherwise damaged, and where directed by the Engineer, the Contractor shall remove a minimum 6-inch thick layer of the subgrade, subbase or base, and replace it with approved 21AA Aggregate material, compacted in place.

The Contractor shall coordinate with the City Forester prior to the removal of any tree roots 2 inches in diameter or greater.

The Contractor shall maintain on-site at all times, a sufficient quantity of adequate materials to protect concrete items. The Engineer may suspend or defer concrete placement if rain protection is not available. The Contractor shall not be entitled to any additional compensation due to work suspension or deferral resulting from a lack of adequate rain protection.

The Contractor is responsible for any damage to concrete items, including but not limited to vandalism; vehicular, pedestrian and/or miscellaneous structural damage; surface texture damage; and rain damage.

MEASUREMENT AND PAYMENT

Payment shall be measured by the exposed face area of the retaining wall in square feet. The sidewalk section will be paid for separately under the appropriate item.

Completed work as measured for this item of work will be paid for at Contract Unit Price for the following Contract (Pay) Item:

PAY ITEMS

Integral Sidewalk Retaining Wall (6" or less)
Integral Sidewalk Retaining Wall (6"-18")

PAY UNIT

Square Foot
Square Foot

The unit prices for these items of work shall include all labor, material, and equipment costs to perform all the work specified in the Standard Specifications and as modified by this Detailed Specification.

**DETAILED SPECIFICATION
FOR
ITEM #217 – REMOVE AND REPLACE BRICK PAVERS, ANY TYPE**

DESCRIPTION

This work shall consist of removing, stockpiling and reinstalling sidewalk pavers, furnishing and installing sand base, concrete base, fine aggregate leveling bed, fine aggregate joint filler, and any additional brick pavers as shown on the Plans, as shown in this Detailed Specification, and as directed by the Engineer.

MATERIALS

Aggregate base, where required, shall consist of MDOT 21AA Limestone in accordance with Section 902 of the 2012 MDOT Standard Specifications for Construction.

Sand base, where required, shall consist of Class II granular material in accordance with Section 902 of the 2012 MDOT Standard Specifications for Construction.

Concrete base, where required, shall be constructed of Class A Portland cement concrete.

Fine aggregate leveling bed shall consist of a 3:1 mix of MDOT 2NS (3 parts) and Type N mortar (1 part). Fine aggregate joint filler shall consist of MDOT 2MS.

Any additional brick pavers required shall match the existing brick in the areas adjoining the removal/replacement limits.

CONSTRUCTION METHODS

The Contractor shall remove and salvage existing pavers, remove any existing mortar or bituminous setting bed and concrete base, to the limits specified by the Engineer, down to the existing aggregate base. Where an existing base is not present, the subbase shall be removed to a sufficient depth for construction of the proposed section as shown on the attached detail, or as directed by the Engineer. Salvaged pavers shall be stored on-site in an area approved by the Engineer until they are ready to be replaced.

The Contractor shall reshape, regrade, and recompact the existing base materials, and shall construct the base to match the existing adjacent elevations.

Fine aggregate and mortar shall be uniformly blended to create the leveling bed mix. Leveling bed is to be placed on aggregate base or existing concrete base to the depth shown on the Plans. Control bars and/or guides shall be used to screed the fine aggregate leveling bed.

Brick installation is to match the pattern of the existing adjacent brickwork. String lines or other devices are to be used as needed to insure straight joint lines and final surface elevations. Paving units are to be butted tight to adjacent concrete paving and to each other. Newly laid pavers are to be protected at all times by plywood panels on which workers stand. A minimum of three (3) passes of a plate vibrator (min. 5,000 lbs compaction force) shall be made to set paving units in leveling course prior to filling joints. Pavers should be protected from chipping and cracking during compaction.

Fine aggregate joint filler shall be spread over paver surface and broomed into joints, and misted

lightly with water to settle sand into joints. Allow to surface dry and repeat process until joints are filled completely. Remove excess sand upon completion.

The Contractor shall take any necessary precautions to prevent damage to pavers during removal and replacement. The Contractor is not entitled to any additional compensation for such replacement of damaged pavers.

MEASUREMENT AND PAYMENT

Completed work as measured for this item of work will be paid for at Contract Unit Price for the following Contract Pay Item:

<u>PAY ITEM</u>	<u>PAY UNIT</u>
Remove and Replace Brick Pavers, Any Type	Square Foot

The unit price for this item of work shall include all labor, material, and equipment costs to perform all the work specified in the Standard Specifications and as modified by this Detailed Specification.

CITY OF ANN ARBOR
DETAILED SPECIFICATION
FOR
DETECTABLE WARNING SURFACE

AA:DAD

1 of 2

04/05/15

a. Description. This work shall consist of furnishing and installing cast in place detectable warning units in compliance to the Americans with Disabilities Act (ADA) Title 49 CFR Transportation, Part 37.9 Standards for Accessible Transportation Facilities, Appendix A, section 4.29.2 Detectable Warnings on Walking Surfaces. All work shall be in accordance with the Special Provision for "Concrete Sidewalk and Sidewalk Ramps", section 803 of the Michigan Department of Transportation (MDOT) 2012 Standard Specifications for Construction, MDOT Standard Plan Series R-28, as indicated on the plans, and as modified herein.

b. Materials. The detectable warning tiles shall be colored as Federal Number 22144 (frequently referred to as "Colonial Red" or "Brick Red").

American Society for Testing and Materials (ASTM) Test Methods B117, C1028, D543, D570, D638, D695, D790, D2486, D2565, D5420, and E84 will apply.

The detectable warning tiles shall meet the following material properties, dimensions, and tolerances using the most current test methods:

1. Water Absorption: Not to exceed 0.35% when tested in accordance with ASTM-D570
2. Slip Resistance: 0.80 minimum combined wet/dry static coefficient of friction on top domes and field area, when tested in accordance with ASTM C1028.
3. Compressive Strength: 18,000 psi minimum, when tested in accordance with ASTM D695.
4. Tensile Strength: 10,000 psi minimum, when tested in accordance with ASTM D638.
5. Flexural Strength: 24,000 psi minimum, when tested in accordance with ASTM D790.
6. Chemical Stain Resistance: No reaction to 1% hydrochloric acid, urine, chewing gum, soap solution, motor oil, bleach, calcium chloride, when tested in accordance with ASTM D543 or D1308.
7. Wear Depth: 300 minimum, when tested in accordance with ASTM C501.
8. Flame Spread: 25 maximum, when tested in accordance with ASTM E84.
9. Gardner Impact: 50 in.-lbs. minimum, when tested in accordance with Geometry "GE" of ASTM D5420.
10. Accelerated Weathering of Tile when tested by ASTM-G155 or ASTM G151 shall exhibit the following result- $\Delta E < 6.0$ as well as no deterioration, fading or chalking of surface when exposed to 3000 hours minimum exposure.
11. Wheel Loading: The cast in place tile shall be mounted on a concrete platform with a 1/2" airspace at the underside of the tile top plate then subjected to the specified maximum load of 10,400 lbs., corresponding to an 8,000 lb individual wheel load and a 30% impact factor. The tile shall exhibit no visible damage at the maximum load of 10,400 lbs using AASHTO-HB17 single sheet HS20-44 loading "Standard Specifications for Highways and Bridges."
12. Salt and Spray Performance of Tile and Adhesive System when tested to ASTM-B117 not to show any deterioration or other defects after 100 hours of exposure

Submit manufacturer’s literature describing products, installation procedures and maintenance instructions. Provide cast-in-place detectable surface tiles and accessories as produced by a single manufacturer.

Samples for Verification Purposes: Submit two (2) tile samples minimum 6” x 8” of the kind proposed for use. Samples shall be properly labeled and shall contain the following information: Name of Project; Submitted by; Date of Submittal; Manufacture’s Name; Catalog No.; and Date of Fabrication.

Material Test Reports: Submit current test reports from a qualified, independent, testing laboratory indicating that materials proposed for use are in compliance with requirements and meet the properties indicated. The required tests listed elsewhere in this Special Provision shall be performed by a certified and qualified independent testing laboratory on a cast-in-place tactile warning system. All test reports submitted shall be certified by the testing laboratory and shall clearly state that all tests were completed within 5 years of the date of the submittal. The manufacturer shall certify in writing that the materials provided to the project are manufactured with the same materials and manufacturing procedures as those used in the materials on which the test were performed.

c. Construction. Installer’s Qualifications: Engage an experienced Installer who has successfully completed tile installations similar in material, design, and extent to that indicated for this Project.

The contractor shall follow manufacturer specifications for installation, except where they conflict with MDOT Standard Plan Series R-28, or other project requirements.

d. Measurement and Payment. The completed work, as described, will be measured and paid for at the contract unit price for the following pay item:

<u>Pay Item</u>	<u>Pay Unit</u>
Detectable Warning Surface, Modified.....	Foot

The unit price for this item shall include all labor, material, and equipment costs required to complete the work.

CITY OF ANN ARBOR
DETAILED SPECIFICATION
FOR
FENCE, PROTECTIVE, MODIFIED

AA:DAD

1 of 2

04/05/15

a. Description. This work shall consist of taking all reasonable measures to protect all existing trees and vegetation designated to remain and be protected within the project limits and the construction influence area, in accordance with subsection 201.03.A.2 and section 808 of the Michigan Department of Transportation (MDOT) 2012 Standard Specifications for Construction, except as specified herein. The work shall also consist of installing protective fencing at the limits of the construction area as shown on the plans or in areas directed by the Engineer.

b. Materials. Fabric shall be orange, vinyl, snow fence material, 4 feet tall. Posts shall be 6 foot long, T-shaped, metal posts or 2 inch square hardwood stakes.

c. Construction. Install protective fence at the limits of the construction area as shown on the plans or as directed by the Engineer.

The Contractor shall not operate equipment within the tree protection fence of any existing tree without the approval of the Engineer.

Construction material, supplies, or equipment shall not be stockpiled or stored within the limits of the tree protection fence.

Vehicles and personnel are not permitted within the limits of the tree protection fence.

The Contractor shall not attach chains, cables, ropes, nails, or other articles to any tree at any time.

Tree roots 1-1/2 inch or greater in diameter exposed during construction must be pruned. All pruning operations shall be reviewed and approved by the Engineer. All root pruning shall be performed with sharp tools and shall provide clean cuts that do not unnecessarily damage the remaining bark or root. The Contractor shall not perform any backfilling operations until all root maintenance has been performed.

Any damage to trees owned by the City of Ann Arbor or other trees designated to be protected due to the Contractor's activities or activities of the Contractor's subcontractors or suppliers shall be repaired under the direction of the City Forester by an approved forestry specialist. The costs of these repairs shall be the sole responsibility of the Contractor.

Should the Contractor's operations damage a plant's roots to the extent that it must be removed, the Contractor shall either replace the plant with a commensurate number of plants, 2½" caliper trees of the species as determined by the City, or compensate the City of Ann Arbor for the cash value of the plant or tree as determined by the City of Ann Arbor's Forester. The City of Ann Arbor shall be solely responsible for determining which compensation method is used.

The City Forester shall supervise the replacement of any trees at the sole expense of the Contractor.

Remove tree protection fence when directed by the Engineer.

d. Measurement and Payment. The completed work, as described, will be measured and paid for at the contract unit price for the following pay item:

Pay Item

Pay Unit

Fence, Protective, Modified Foot

Fence, Protective, Modified will be measured in length, by feet of protective fence used, and will be paid for at the contract unit price which shall be payment in full for all labor, materials, and equipment needed to accomplish this work. No additional payment will be made for maintenance or reinstallation of fence during the construction period. No additional payment will be made for repair or replacement of vegetation as noted above.

**DETAILED SPECIFICATION
FOR
PAVEMENT MARKINGS**

1 of 2

a. Description This work consists of providing and placing permanent pavement markings in accordance with the Michigan Manual on Uniform Traffic Control Devices. Provide markings, legends, symbols, spacing, and dimensions that conform to the plans, the City of Ann Arbor Standard Specifications, 2012 Michigan Department of Transportation Standard Specifications for Construction, and as specified herein.

b. Materials Provide materials in accordance with Sections 811 and 920 of the 2012 Michigan Department of Transportation Standard Specifications for Construction. Provide the Material Safety Data Sheets to the Engineer for required materials and supplies. Dispose of unused material and containers in accordance with the Federal Resource Conservation Recovery Act (RCRA) of 1976 as amended, and 1994 PA 451, Part 111 Hazardous Waste Management. Provide samples of permanent pavement marking materials upon request.

Thermoplastic materials provided shall be in accordance with Section 920 Sprayable Thermoplastic Pavement Marking Material

c. Construction Methods The preparation and placement of permanent pavement markings shall conform to Section 811 of the 2012 MDOT Standard Specifications for Construction, the City of Ann Arbor Standard Specifications, the plans, and as specified herein.

All permanent markings are to be recessed in accordance with Detailed Specifications included in the contract documents.

d. Measurement and Payment The measurement and payment for thermoplastic pavement markings shall be in accordance with Section 811.04 of the 2012 MDOT Standard Specifications for Construction, the City of Ann Arbor Standard Specifications, the plans, and as specified herein.

The unit prices for these items of work shall include all labor, material, and equipment costs to perform all the work specified in the Sections 811 and 920 of the 2012 MDOT Standard Specifications and as modified by this Detailed Specification.

The completed work as measured for these items of work will be paid for at the Contract Unit Price for the following Contract (Pay) Items:

PAY ITEM

PAY UNIT

Pavt Mrkg Hot-Applied Thermoplastic __ inch White	Lineal Foot
Pavt Mrkg Hot-Applied Thermoplastic __ inch Yellow	Lineal Foot
Pavt Mrkg Hot-Applied Thermoplastic __ inch Crosswalk	Lineal Foot
Pavt Mrkg Hot-Applied Thermoplastic __ inch Stop Bar	Lineal Foot
Pavt Mrkg Overlay Cold Plastic White Only	Each
Pavt Mrkg Overlay Cold Plastic White _____ Arrow	Each
Pavt Mrkg Overlay Cold Plastic White Bike Symbol	Each
Pavt Mrkg Overlay Cold Plastic White Bike Sharrow	Each
Recessed Pavt Mrkg, Thermoplastic, Parking	Each

**DETAILED SPECIFICATION
FOR
PAVEMENT MARKINGS**

1 of 2

All work indicated herein shall be included in the unit prices for the above pay items and shall include all labor, materials and equipment required to complete the work.

The item Recessed Pavt Mrkg, Thermoplastic, Parking includes all materials in addition to recessing the pavement marking as detailed elsewhere in this contract.

CITY OF ANN ARBOR
DETAILED SPECIFICATION
FOR
MAINTAINING TRAFFIC

AA:DAD

1 of 4

04/08/15

a. Description. Traffic shall be maintained by the Contractor throughout the project duration in accordance with the City of Ann Arbor Standard Specifications, subsection 104.11 and section 812 of the Michigan Department of Transportation (MDOT) 2012 Standard Specifications for Construction, the Michigan Manual of Uniform Traffic Control Devices (MMUTCD), applicable supplemental specifications, as directed by the Engineer, and as herein specified.

The following, and herein included, Michigan Department of Transportation (MDOT) Maintaining Traffic Typical and Work Zone Device Details apply to the project: m0020a, m0040a, m0110a, m0140a, WZD-100-A, and WZD-125-E.

These maintaining traffic provisions are subject to change in the event of special community activities.

The permanent pavement marking items are included in the contract and shall be placed per the MDOT 2012 Standard Specifications for Construction prior to the removal of any devices required to temporarily maintain traffic during construction, and also prior to opening the project to traffic.

b. Materials. Materials for all devices used to temporarily control and maintain traffic shall meet the requirements of section 812 of the MDOT 2012 Standard Specifications for Construction, the MMUTCD, and the applicable MDOT typicals and details included herein.

All signs shall be 48 inches by 48 inches, unless otherwise noted. Temporary signs, which are to remain in the same place for 14 days or more, shall be installed on driven posts. All other temporary signs may be installed on portable supports. All signs shall have a minimum bottom height of 7.0 feet.

Channelizing devices required for all lane closures shall be plastic drums.

c. Construction. Construction methods shall meet the requirements of section 812 of the MDOT 2012 Standard Specifications for Construction.

The Contractor shall furnish and place all necessary temporary traffic control devices to maintain traffic during construction. All work, construction equipment, and material storage shall be kept behind the curb, or behind barricades or channelizing devices, all in combination with protective fencing, if required to protect open excavations, and shall not in any way hamper vehicle movement or impair traffic vision. The contractor shall also provide protection to all uncured concrete sidewalk, driveways, and curb and gutter as may be needed until all traffic, either foot or otherwise, can cross without damage. Additional barricades and protective fencing shall be installed at the end of each day to insure no disturbance to the work area.

Distances between warning, regulatory, and guide signs as shown on the typicals and details are approximate, and may require field adjustment, as directed by the Engineer.

The Contractor shall maintain two-way traffic on major streets, access for local traffic on local streets, and keep all intersections open to traffic at all times, unless specifically authorized in writing by the Engineer.

The Contractor shall maintain traffic such that no vehicle shall be required to drive into active work areas. Patch areas which extend more than halfway across the roadway shall be removed and replaced so as to provide a minimum of half the pavement width at all times for maintaining traffic.

All temporary traffic/pedestrian control devices furnished by the Contractor shall remain the property of the Contractor. The City shall not be responsible for stolen or damaged signs, barricades, plastic drums and other traffic maintenance items. The Contractor shall replace missing and/or damaged traffic control devices immediately, at no additional cost to the City.

1. Construction Influence Area (CIA). The CIA shall consist of the width of the project right-of-way and easements, and 250 feet in either direction of Redeemer Ave along Pauline Blvd, and 250 feet northerly along Soule Blvd.

The Contractor shall furnish, erect, maintain, and upon completion of the work, remove all traffic control devices within and around the CIA for the safety and protection of traffic. This includes, but is not limited to, regulatory and warning signs, barricades, channeling devices and other minor devices where required by the Engineer.

The Contractor shall coordinate its operations with all subcontractors, utilities, and/or other contractors performing work on this and other projects within, or adjacent to, the Construction Influence Area (CIA). The contractor shall avoid conflicts in maintaining traffic operations, signing, and orderly progress of other contract work.

2. Permits. Prior to the start of construction, the Contractor shall obtain a "Right-of-Way" Permit from City of Ann Arbor Customer Services Unit. The Contractor shall notify the Project Engineer and obtain a "Traffic Detour or Lane Closure" Permit from City of Ann Arbor Project Management Services Unit a minimum of 72 business hours prior to the implementation of any traffic shifts, lane closures and street closures. The fees for these permits will be waived.

3. Work Times and Restrictions. All work shall be conducted Monday through Saturday between 7:00am and 8:00pm; unless an alternate plan identifying the days and hours of work has been authorized by the City prior to commencement of construction. Should night work be required for any reason, the Project Engineer must be notified three (3) working days (72 hours) in advance of such work, and the work must have the approval of the City prior to commencement.

Only work of an emergency nature or work required to insure traffic safety shall be performed on Sunday and only with prior approval by the City.

No road work shall be performed nor traffic interruptions be permitted, including lane closures, on Sundays, and during the July 4th and Labor Day holiday periods. All streets and sidewalks that can be opened shall be opened. Trucking on or off site will not be permitted.

During non-working periods, any area with uncompleted work shall have plastic drums at specific locations and protective fencing, as directed by the Engineer, and at no additional cost to the project.

4. Traffic Restrictions. The Contractor shall, at all times, conduct its work to insure the least possible obstruction to traffic and inconvenience to the general public, businesses, and residents in the vicinity of the work.

Traffic on major streets, including Pauline Blvd, should not be impacted between the hours of 7:00 a.m. to 9:00 a.m. and from 3:30 p.m. to 6:00 p.m. unless otherwise approved by the Engineer or as specified on the Lane Closure Permit. All major changes in traffic control shall be made either between 9:00 a.m. and 3:30 p.m. or between 7:00 p.m. and 6:30 a.m. in order to minimize interference with rush hour traffic. All traffic controls must be in place and ready for traffic each day by 6:30 a.m. and 3:30 p.m. Temporary obstruction of traffic for loading and unloading of trucks will be permitted if the Contractor provides traffic regulators (flag persons) in conformance with Part VI of the MMUTCD. During temporary obstructions, a minimum of two traffic regulators are required. The cost of traffic regulators (flag control) shall be included in the contract pay item "Minor Traffic Control, Modified, Max \$_".

Access to businesses, residences, and side street(s) within the CIA shall be maintained for the duration of the project. The Contractor shall make every effort to coordinate its operations to minimize interruptions impacting this access. The Contractor shall notify the Project Engineer forty-eight (48) hours in advance of any work to be performed on or near business or residential driveways, and stage work so that it is part-width when it is necessary to work in these areas. Prohibiting access to businesses and residences will not be allowed during any phase of construction, and flagging will be required at the discretion of the Engineer.

A minimum of one lane of traffic in each direction must be maintained on Pauline Blvd at all times by use of signage and other traffic control devices unless other authorized by the Engineer.

Lane width shall be a minimum of 9 feet wide. Contractor shall schedule work so that under no circumstances traffic is stopped. The work within the CIA shall be suspended, during peak traffic hours and/or when traffic is being unduly hampered or delayed by all construction activity, at the discretion of the Engineer.

5. Emergency Services. The Contractor shall notify local police, fire departments and emergency response units a minimum of three business days (72 hours) prior to the closure of any lanes, or traffic shifts causing restricted movements of traffic or restricted access. Fire hydrants in or adjacent to the work shall be kept "live" and fire fighting forces made aware of their availability at all times during construction.

d. Measurement and Payment. The completed work for maintaining traffic, as described, will be paid for at the contract unit prices for the following items in accordance with subsection 812.04 of the Standard Specifications for Construction.

<u>Pay Item</u>	<u>Pay Unit</u>
Barricade, Type III, High Intensity, Double Sided, Furn	Each
Barricade, Type III, High Intensity, Double Sided, Oper	Each
Lighted Arrow, Type C, Furn.....	Each
Lighted Arrow, Type C, Oper	Each
Plastic Drum, High Intensity, Furn	Each
Plastic Drum, High Intensity, Oper	Each
Sign, Portable, Changeable Message, Furn	Each
Sign, Portable, Changeable Message, Oper.....	Each
Sign, Type B, Temp, Prismatic, Furn	Square Foot
Sign, Type B, Temp, Prismatic, Oper	Square Foot
Sign, Type B, Temp, Prismatic, Special, Furn.....	Square Foot
Sign, Type B, Temp, Prismatic, Special, Oper	Square Foot
Traf Regulator Control	Lump Sum
Minor Traffic Control, Modified, Max \$_	Lump Sum

The estimated quantities for maintaining traffic are based on the signing and related traffic control devices deemed necessary for this project as shown on the applicable MDOT Maintaining Traffic Typical, and include traffic regulators, lighted arrows and minor traffic devices.

Payment for traffic control devices shall be based on the maximum quantity in place at any one time during the project, as determined by the Engineer. Non-standard specially fabricated signs, other than those used to determine the maximum square feet of signage, will be paid for separately by the unit square foot for each sign furnished and operated during construction.

Any additional signing or maintaining traffic devices required to expedite the construction shall be at the Contractor's expense.

Temporary traffic control devices will be paid for only once irrespective of the number of times moved. Traffic control devices not paid for separately shall be included in the payment for the pay item "Minor Traffic Control, Modified, Max \$_".

MINIMUM MERGING TAPER LENGTH "L" (FEET)

OFFSET FEET	POSTED SPEED LIMIT, MPH (PRIOR TO WORK AREA)									
	25	30	35	40	45	50	55	60	65	70
1	10	15	20	27	45	50	55	60	65	70
2	21	30	41	53	90	100	110	120	130	140
3	31	45	61	80	135	150	165	180	195	210
4	42	60	82	107	180	200	220	240	260	280
5	52	75	102	133	225	250	275	300	325	350
6	63	90	123	160	270	300	330	360	390	420
7	73	105	143	187	315	350	385	420	455	490
8	83	120	163	213	360	400	440	480	520	560
9	94	135	184	240	405	450	495	540	585	630
10	104	150	204	267	450	500	550	600	650	700
11	115	165	225	293	495	550	605	660	715	770
12	125	180	245	320	540	600	660	720	780	840
13	135	195	266	347	585	650	715	780	845	910
14	146	210	286	374	630	700	770	840	910	980
15	157	225	307	400	675	750	825	900	975	1050

TAPER LENGTH "L" IN FEET

THE FORMULAS FOR THE MINIMUM LENGTH OF A MERGING TAPER IN DERIVING THE "L" VALUES SHOWN IN THE ABOVE TABLES ARE AS FOLLOWS:

"L" = $\frac{W \times S^2}{60}$ WHERE POSTED SPEED PRIOR TO THE WORK AREA IS 40 MPH OR LESS

"L" = S x W WHERE POSTED SPEED PRIOR TO THE WORK AREA IS 45 MPH OR GREATER

- L = MINIMUM LENGTH OF MERGING TAPER
- S = POSTED SPEED LIMIT IN MPH PRIOR TO WORK AREA
- W = WIDTH OF OFFSET

TYPES OF TAPERS

UPSTREAM TAPERS

- MERGING TAPER
- SHIFTING TAPER
- SHOULDER TAPER
- TWO-WAY TRAFFIC TAPER

DOWNSTREAM TAPERS

(USE IS OPTIONAL)

TAPER LENGTH

- L - MINIMUM
- 1/2 L - MINIMUM
- 1/3 L - MINIMUM
- 100' - MAXIMUM
- 100' - MINIMUM (PER LANE)

 TRAFFIC AND SAFETY MAINTAINING TRAFFIC TYPICAL	TABLES FOR "L", "D" AND "B" VALUES		
	DRAWN BY: CON:AE:djf CHECKED BY: BMM	JUNE 2006 PLAN DATE:	M0020a
FILE: K:/DGN/TSR/STDS/ENGLISH/MNTTRF/M0020a.dgn REV. 08/21/2006			

DISTANCE BETWEEN TRAFFIC CONTROL DEVICES "D"
AND LENGTH OF LONGITUDINAL BUFFER SPACE ON
"WHERE WORKERS PRESENT" SEQUENCES

"D" DISTANCES	POSTED SPEED LIMIT, MPH (PRIOR TO WORK AREA)									
	25	30	35	40	45	50	55	60	65	70
D (FEET)	250	300	350	400	450	500	550	600	650	700

GUIDELINES FOR LENGTH OF
LONGITUDINAL BUFFER SPACE "B"

SPEED* MPH	LENGTH FEET
20	33
25	50
30	83
35	132
40	181
45	230
50	279
55	329
60	411
65	476
70	542

* POSTED SPEED, OFF PEAK 85TH PERCENTILE SPEED PRIOR TO WORK STARTING, OR THE ANTICIPATED OPERATING SPEED

1 BASED UPON AMERICAN ASSOCIATION OF STATE HIGHWAY AND TRANSPORTATION OFFICIALS (AASHTO) BRAKING DISTANCE PORTION OF STOPPING SIGHT DISTANCE FOR WET AND LEVEL PAVEMENTS (A POLICY ON GEOMETRIC DESIGN OF HIGHWAY AND STREETS), AASHTO. THIS AASHTO DOCUMENT ALSO RECOMMENDS ADJUSTMENTS FOR THE EFFECT OF GRADE ON STOPPING AND VARIATION FOR TRUCKS.

 TRAFFIC AND SAFETY MAINTAINING TRAFFIC TYPICAL	TABLES FOR "L", "D" AND "B" VALUES		
	DRAWN BY: CON:AE:djf CHECKED BY: BMM	JUNE 2006 PLAN DATE:	M0020a
FILE: K:/DGN/TSR/STDS/ENGLISH/MNTTRF/M0020a.dgn REV. 08/21/2006			

SIGN PLACEMENT IS THE SAME FOR BOTH DIRECTIONS

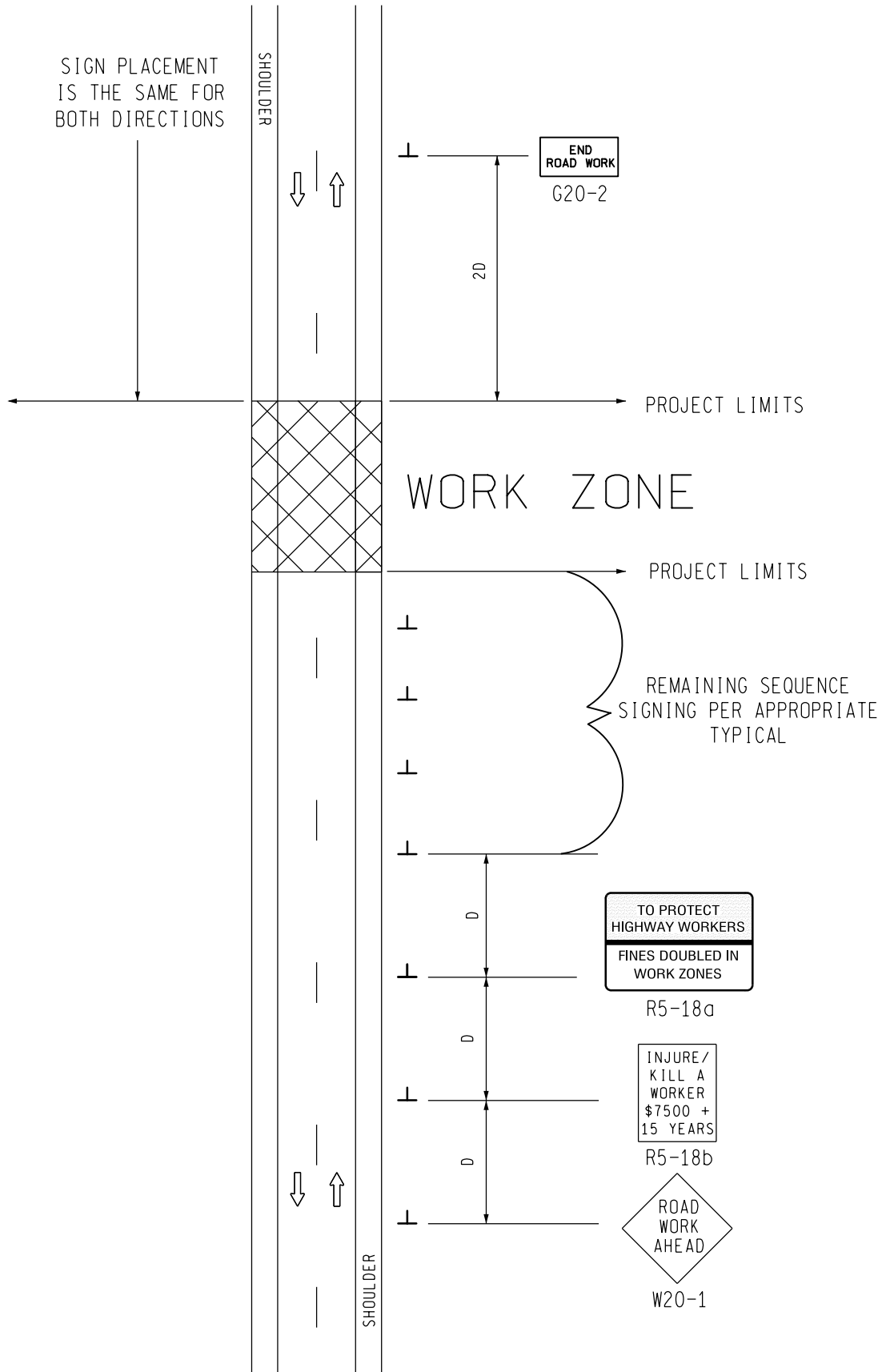

SIGN = 68 f+2 - TYPE B
FOR ONE DIRECTION OF TRAFFIC
W20-1 QUANTITY INCLUDED
WITH APPROPRIATE TYPICAL
FOR SEQUENCE SIGNING

MDOT
Michigan Department of Transportation
TRAFFIC AND SAFETY
MAINTAINING TRAFFIC
TYPICAL

TYPICAL ADVANCE SIGNING TREATMENT FOR LONG, INTERMEDIATE AND SHORT TERM STATIONARY WORK ZONE OPERATIONS OF LESS THAN TWO MILES IN LENGTH WHERE TRAFFIC CONTROL DEVICES MAY REMAIN AT END OF WORK DAY ON AN UNDIVIDED TWO-WAY ROADWAY

DRAWN BY: CON:AE:djf
CHECKED BY: BMM:CRB

OCTOBER 2011
PLAN DATE:

M0040a

SHEET
1 OF 2

NOT TO SCALE

FILE: PW_BB/TS/Typicals/Signs/MT NON FWY/M0040a.dgn REV. 10/13/2011

NOTES

- 30. THE APPROPRIATE ADVANCE SIGNING SEQUENCE(S), (M0030a THROUGH M0080a) SHALL BE USED ON ALL PROJECTS.
- 32. THESE SIGNS SHALL BE LEFT IN PLACE AT THEIR PRESCRIBED LOCATIONS FOR THE DURATION OF THE PROJECT AND UNTIL ALL TEMPORARY TRAFFIC CONTROL HAS BEEN REMOVED.
- 35. THESE SIGNS ARE INTENDED TO BE USED WITHIN THE LIMITS OF THE TEMPORARY SEQUENCE SIGNING AS IS SHOWN ON 1 OF 2. THESE SIGNS ARE NOT TO BE INTERMINGLED WITH ANY OTHER TEMPORARY SEQUENCE SIGNING EXCEPT AS SHOWN.



SIGN SIZES

G20-2	-	48" x 24"
R5-18a	-	96" x 60"
R5-18b	-	48" x 60"
W20-1	-	48" x 48"

 MDOT Michigan Department of Transportation TRAFFIC AND SAFETY MAINTAINING TRAFFIC TYPICAL	TYPICAL ADVANCE SIGNING TREATMENT FOR LONG, INTERMEDIATE AND SHORT TERM STATIONARY WORK ZONE OPERATIONS OF LESS THAN TWO MILES IN LENGTH WHERE TRAFFIC CONTROL DEVICES MAY REMAIN AT END OF WORK DAY ON AN UNDIVIDED TWO-WAY ROADWAY		
	DRAWN BY: CON:AE:djf	OCTOBER 2011	M0040a
CHECKED BY: BMM:CRB	PLAN DATE:	2 OF 2	
FILE: PW-PB/TS/Typicals/Signs/MT NON FWY/M0040a.dgn REV. 10/13/2011			

NOT TO SCALE

KEY

- • • CHANNELIZING DEVICES
-  LIGHTED ARROW PANEL (CAUTION MODE)
-  TRAFFIC FLOW
- REFLECTS EXISTING SPEED LIMIT
- * USE THE "NEXT -- MILES" SIGN WHEN SHOULDER CLOSURE EXCEEDS 1 MILE IN LENGTH

SIGN = 120 ft± - TYPE B
 W/PLAQUE = 132 ft± - TYPE B
 PLUS ADDITIONAL R2-1's
 THROUGHOUT WORK AREA

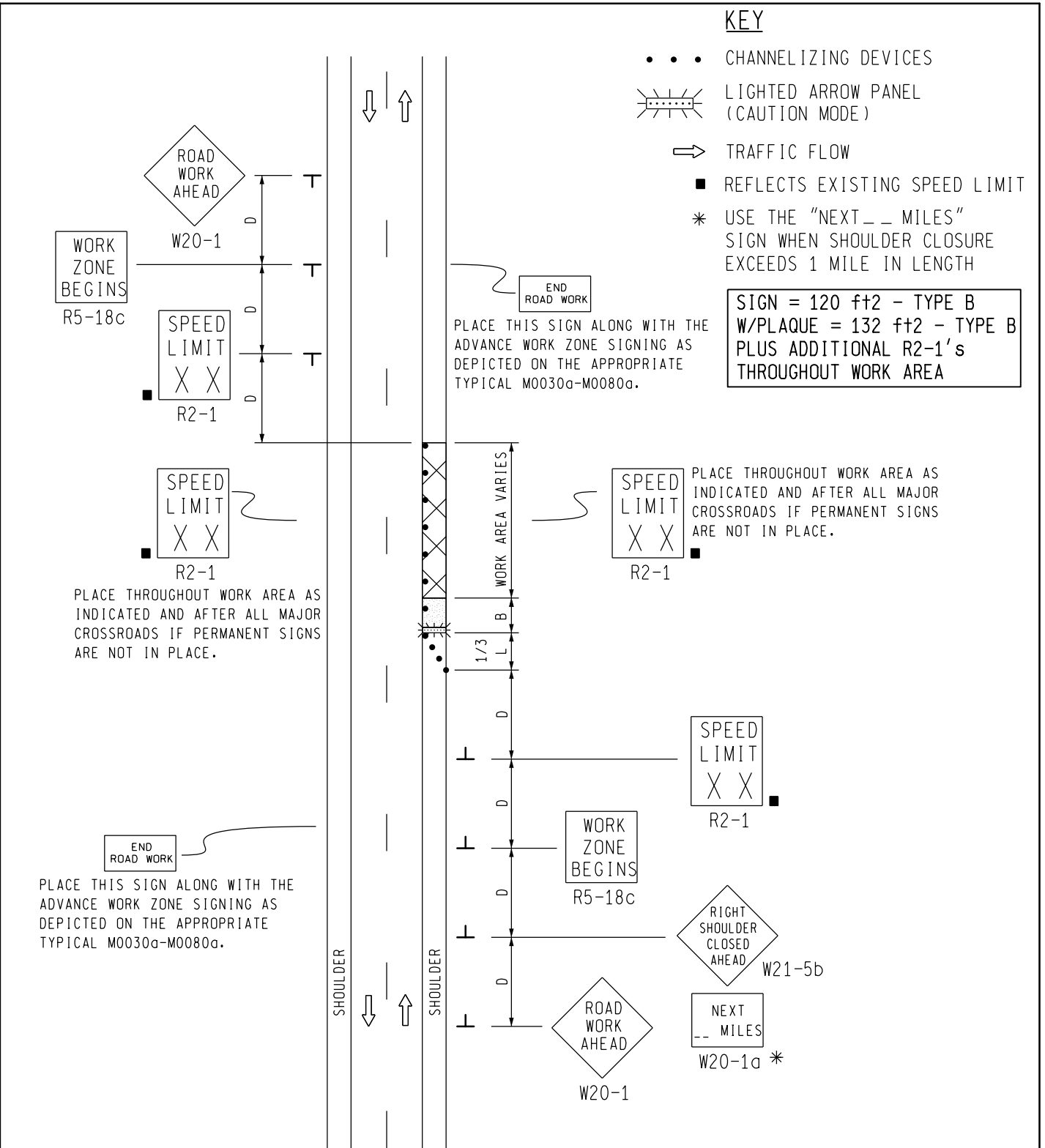

MDOT
 Michigan Department of Transportation
 TRAFFIC AND SAFETY
 MAINTAINING TRAFFIC
 TYPICAL

TYPICAL TEMPORARY TRAFFIC CONTROL
 FOR A SHOULDER CLOSURE ON A TWO
 LANE TWO-WAY ROADWAY
 NO SPEED REDUCTION

DRAWN BY: CON:AE:djf	OCTOBER 2011	M0110a	SHEET 1 OF 2
CHECKED BY: BMM:CRB	PLAN DATE:		

NOT TO SCALE

NOTES

1. D = DISTANCE BETWEEN TRAFFIC CONTROL DEVICES
 $1/3 L$ = MINIMUM LENGTH OF TAPER
 B = LENGTH OF LONGITUDINAL BUFFER
 SEE M0020a FOR "D," "L," AND "B" VALUES
2. ALL NON-APPLICABLE SIGNING WITHIN THE CIA SHALL BE MODIFIED TO FIT CONDITIONS, COVERED OR REMOVED.
3. DISTANCES BETWEEN SIGNS, THE VALUES FOR WHICH ARE SHOWN IN TABLE D, ARE APPROXIMATE AND MAY NEED ADJUSTING AS DIRECTED BY THE ENGINEER.
- 3A. THE "WORK ZONE BEGINS" (R5-18c) SIGN SHALL BE USED ONLY IN THE INITIAL SIGNING SEQUENCE IN THE WORK ZONE. SUBSEQUENT SEQUENCES IN THE SAME WORK ZONE SHALL OMIT THIS SIGN AND THE QUANTITIES SHALL BE ADJUSTED APPROPRIATELY.
- 4E. THE MAXIMUM RECOMMENDED DISTANCE(S) BETWEEN CHANNELIZING DEVICES SHOULD BE EQUAL IN FEET TO THE POSTED SPEED IN MILES PER HOUR ON TAPER(S) AND TWICE THE POSTED SPEED IN THE PARALLEL AREA(S).
5. FOR OVERNIGHT CLOSURES, TYPE III BARRICADES SHALL BE LIGHTED.
6. WHEN CALLED FOR IN THE FHWA ACCEPTANCE LETTER FOR THE SIGN SYSTEM SELECTED, THE TYPE A WARNING FLASHER, SHOWN ON THE WARNING SIGNS, SHALL BE POSITIONED ON THE SIDE OF THE SIGN NEAREST THE ROADWAY.
7. ALL TEMPORARY SIGNS, TYPE III BARRICADES, THEIR SUPPORT SYSTEMS AND LIGHTING REQUIREMENTS SHALL MEET NCHRP 350 CRASHWORTHLY REQUIREMENTS STIPULATED IN THE CURRENT EDITION OF THE MICHIGAN MANUAL ON UNIFORM TRAFFIC CONTROL DEVICES, THE CURRENT EDITION OF THE STANDARD SPECIFICATIONS FOR CONSTRUCTION, THE STANDARD PLANS AND APPLICABLE SPECIAL PROVISIONS. ONLY DESIGNS AND MATERIALS APPROVED BY MDOT WILL BE ALLOWED.
8. WHEN BUFFER AREAS ARE ESTABLISHED, THERE SHALL BE NO EQUIPMENT OR MATERIALS STORED OR WORK CONDUCTED IN THE BUFFER AREA.
- 29A. THE TYPE OF REFLECTIVE SHEETING USED FOR THE W20-1a PLAQUE SHALL BE THE SAME AS THE TYPE USED FOR THE PARENT SIGN.

SIGN SIZES

DIAMOND WARNING	- 48" x 48"
W20-1a PLAQUE	- 48" x 36"
R2-1 REGULATORY	- 48" x 60"
R5-18c REGULATORY	- 48" x 48"

NOT TO SCALE

 TRAFFIC AND SAFETY MAINTAINING TRAFFIC TYPICAL	TYPICAL TEMPORARY TRAFFIC CONTROL FOR A SHOULDER CLOSURE ON A TWO LANE TWO-WAY ROADWAY NO SPEED REDUCTION	
	DRAWN BY: CON:AE:djf CHECKED BY: BMM:CRB	OCTOBER 2011 PLAN DATE:
FILE: PW-RD/TS/Typicals/Signs/MT NON FWY/M0110a.dgn REV. 10/04/2011		





PLACE THROUGHOUT WORK AREA AS INDICATED AND AFTER ALL MAJOR CROSSROADS IF PERMANENT SIGNS ARE NOT IN PLACE.

PLACE THIS SIGN ALONG WITH THE ADVANCE WORK ZONE SIGNING AS DEPICTED ON THE APPROPRIATE TYPICAL M0030a-M0080a.

PLACE THROUGHOUT WORK AREA AS INDICATED AND AFTER ALL MAJOR CROSSROADS IF PERMANENT SIGNS ARE NOT IN PLACE.

PLACE THIS SIGN ALONG WITH THE ADVANCE WORK ZONE SIGNING AS DEPICTED ON THE APPROPRIATE TYPICAL M0030a-M0080a.

KEY

-  TRAFFIC REGULATOR
-  CHANNELIZING DEVICES
-  LIGHTED ARROW PANEL (CAUTION MODE)
-  TRAFFIC FLOW
-  REFLECTS EXISTING SPEED LIMIT

SIGN = 200 ft± - TYPE B PLUS ADDITIONAL R2-1's THROUGHOUT WORK AREA

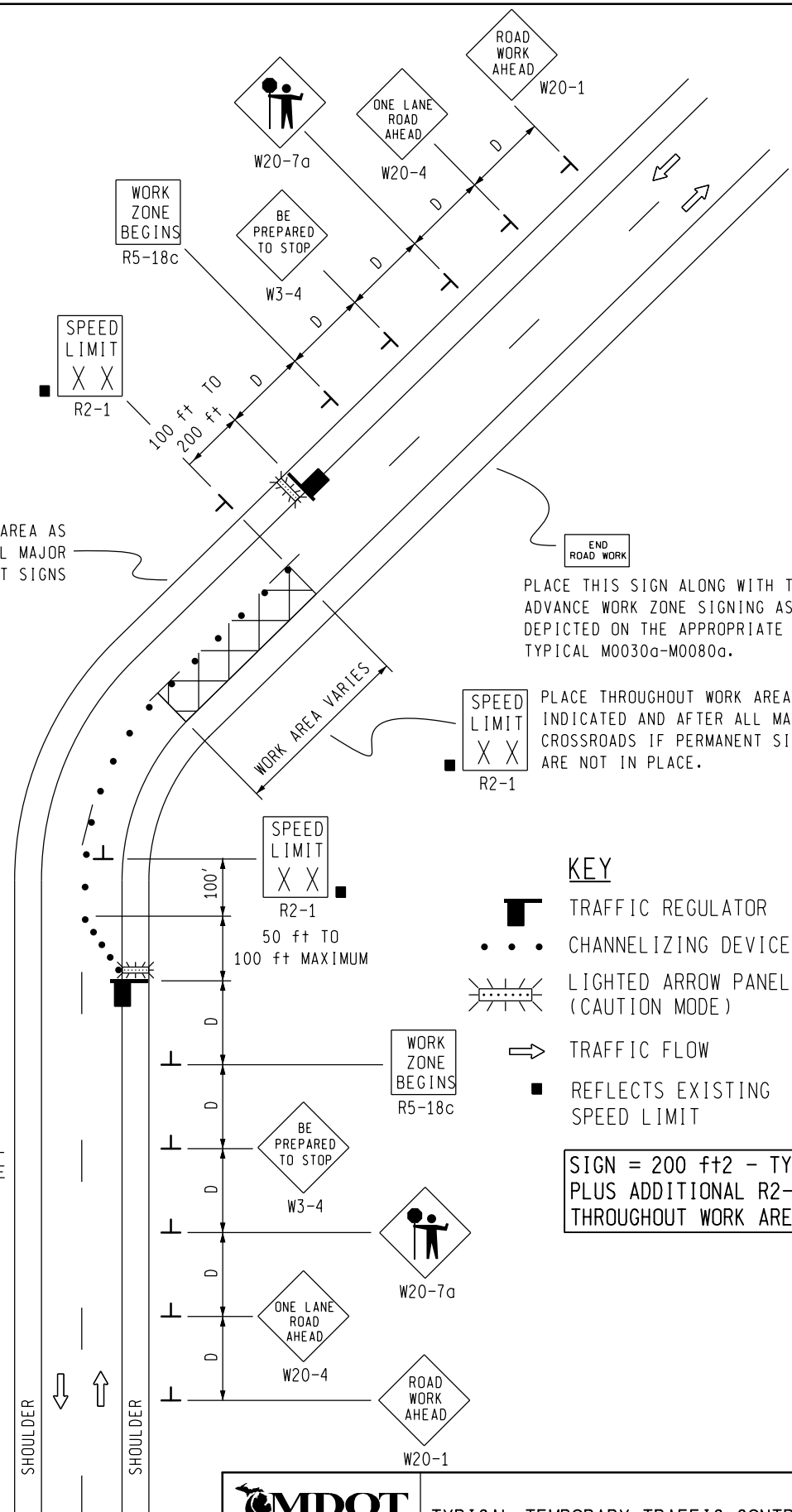

MDOT
Michigan Department of Transportation
TRAFFIC AND SAFETY
MAINTAINING TRAFFIC
TYPICAL

TYPICAL TEMPORARY TRAFFIC CONTROL FOR A TWO-LANE TWO-WAY ROADWAY WHERE ONE LANE IS CLOSED UTILIZING TRAFFIC REGULATORS, NO SPEED REDUCTION

DRAWN BY: CON:AE:djf
CHECKED BY: BMM:CRB

OCTOBER 2011
PLAN DATE:

M0140a

SHEET
1 OF 2

NOT TO SCALE

NOTES

- 1H. D = DISTANCE BETWEEN TRAFFIC CONTROL DEVICES AND LENGTH OF LONGITUDINAL BUFFERS
SEE **M0020a** FOR "D" VALUES.
2. ALL NON-APPLICABLE SIGNING WITHIN THE CIA SHALL BE MODIFIED TO FIT CONDITIONS, COVERED OR REMOVED.
3. DISTANCES BETWEEN SIGNS, THE VALUES FOR WHICH ARE SHOWN IN TABLE D, ARE APPROXIMATE AND MAY NEED ADJUSTING AS DIRECTED BY THE ENGINEER.
- 3A. THE "WORK ZONE BEGINS" (R5-18c) SIGN SHALL BE USED ONLY IN THE INITIAL SIGNING SEQUENCE IN THE WORK ZONE. SUBSEQUENT SEQUENCES IN THE SAME WORK ZONE SHALL OMIT THIS SIGN AND THE QUANTITIES SHALL BE ADJUSTED APPROPRIATELY.
- 4A. THE MAXIMUM RECOMMENDED DISTANCE(S) BETWEEN CHANNELIZING DEVICES IN THE TAPER AREA(S) SHOULD BE 15 FEET AND SHOULD BE EQUAL IN FEET TO TWICE THE POSTED SPEED IN MILES PER HOUR IN THE PARALLEL AREA(S).
5. FOR OVERNIGHT CLOSURES, TYPE III BARRICADES SHALL BE LIGHTED.
6. WHEN CALLED FOR IN THE FHWA ACCEPTANCE LETTER FOR THE SIGN SYSTEM SELECTED, THE TYPE A WARNING FLASHER, SHOWN ON THE WARNING SIGNS, SHALL BE POSITIONED ON THE SIDE OF THE SIGN NEAREST THE ROADWAY.
7. ALL TEMPORARY SIGNS, TYPE III BARRICADES, THEIR SUPPORT SYSTEMS AND LIGHTING REQUIREMENTS SHALL MEET NCHRP 350 CRASHWORTHLY REQUIREMENTS STIPULATED IN THE CURRENT EDITION OF THE MICHIGAN MANUAL ON UNIFORM TRAFFIC CONTROL DEVICES, THE CURRENT EDITION OF THE STANDARD SPECIFICATIONS FOR CONSTRUCTION, THE STANDARD PLANS AND APPLICABLE SPECIAL PROVISIONS. ONLY DESIGNS AND MATERIALS APPROVED BY MDOT WILL BE ALLOWED.
9. ALL TRAFFIC REGULATORS SHALL BE PROPERLY TRAINED AND SUPERVISED.
- 9A. IN ANY OPERATION INVOLVING MORE THAN ONE TRAFFIC REGULATOR, ONE PERSON SHOULD BE DESIGNATED AS HEAD TRAFFIC REGULATOR.
10. ALL TRAFFIC REGULATORS' CONDUCT, THEIR EQUIPMENT, AND TRAFFIC REGULATING PROCEDURES SHALL CONFORM TO THE CURRENT EDITION OF THE MICHIGAN MANUAL OF UNIFORM TRAFFIC CONTROL DEVICES (MMUTCD) AND THE CURRENT EDITION OF THE MDOT HANDBOOK ENTITLED "TRAFFIC REGULATORS INSTRUCTION MANUAL."
11. WHEN TRAFFIC REGULATING IS ALLOWED DURING THE HOURS OF DARKNESS, APPROPRIATE LIGHTING SHALL BE PROVIDED TO SUFFICIENTLY ILLUMINATE THE TRAFFIC REGULATOR'S STATIONS.
- 12E. THE MAXIMUM DISTANCE BETWEEN THE TRAFFIC REGULATORS SHALL BE NO MORE THAN 2 MILES IN LENGTH UNLESS RESTRICTED FURTHER IN THE SPECIAL PROVISIONS FOR MAINTAINING TRAFFIC. ALL SEQUENCES OF MORE THAN 2 MILES IN LENGTH WILL REQUIRE WRITTEN PERMISSION FROM THE ENGINEER BEFORE PROCEEDING.
13. WHEN INTERSECTING ROADS OR SIGNIFICANT TRAFFIC GENERATORS (SHOPPING CENTERS, MOBILE HOME PARKS, ETC.) OCCUR WITHIN THE ONE-LANE TWO-WAY OPERATION, INTERMEDIATE TRAFFIC REGULATORS AND APPROPRIATE SIGNING SHALL BE PLACED AT THESE LOCATIONS.
14. ADDITIONAL SIGNING AND/OR ELONGATED SIGNING SEQUENCES SHOULD BE USED WHEN TRAFFIC VOLUMES ARE SIGNIFICANT ENOUGH TO CREATE BACKUPS BEYOND THE W3-4 SIGNS.
15. THE HAND HELD (PADDLE) SIGNS REQUIRED BY THE MMUTCD TO CONTROL TRAFFIC WILL BE PAID FOR AS PART OF FLAG CONTROL.
- 28E. THE TRAFFIC REGULATORS SHOULD BE POSITIONED AT OR NEAR THE SIDE OF THE ROAD SO THAT THEY ARE SEEN CLEARLY AT A MINIMUM DISTANCE OF 500 FEET. THIS MAY REQUIRE EXTENDING THE BEGINNING OF THE LANE CLOSURE TO OVERCOME VIEWING PROBLEMS CAUSED BY HILLS AND CURVES.

SIGN SIZES

DIAMOND WARNING - 48" x 48"
 R2-1 REGULATORY - 48" x 60"
 R5-18c REGULATORY - 48" x 48"

NOT TO SCALE

 TRAFFIC AND SAFETY MAINTAINING TRAFFIC TYPICAL	TYPICAL TEMPORARY TRAFFIC CONTROL FOR A TWO-LANE TWO-WAY ROADWAY WHERE ONE LANE IS CLOSED UTILIZING TRAFFIC REGULATORS, NO SPEED REDUCTION		
DRAWN BY: CON:AE:djf	OCTOBER 2011	M0140a	
CHECKED BY: BMM:CRB	PLAN DATE:		
FILE: PW-PD/TS/Typicals/Signs/MT NON FWY/M0140a.dgn REV. 10/04/2011			

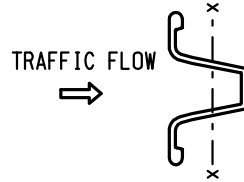
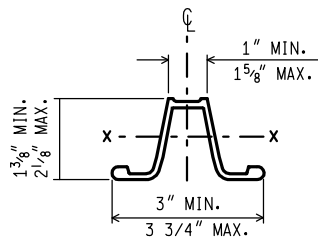
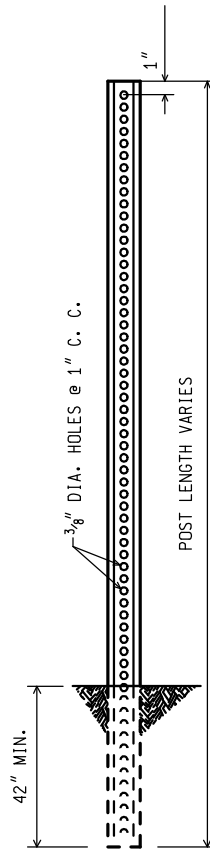

WEIGHT = 3 lbs/ft
 SECT. MOD. X.-X. = 0.31 CUBIC INCHES MIN.

3 lb. U - CHANNEL STEEL POST (NO SPLICE)

MOUNT SIGN ON OPEN FACE OF
 U - CHANNEL STEEL POST

NOT TO SCALE

MICHIGAN DEPARTMENT OF TRANSPORTATION
 BUREAU OF HIGHWAYS DELIVERY STANDARD PLAN

PENDING

 FHWA APPROVAL DATE

8/2006

 PLAN DATE

WZD-100-A

SHEET
 4 of 11

File:PW/Doc/RD/T&S/Typ/Dev/Sign MainTraf D/WZD-100-A Rev. 8/21/06 ECH

NOTE: THE ORIGINAL SIGNED COPY IS KEPT ON FILE AT THE MICHIGAN DEPARTMENT OF TRANSPORTATION.

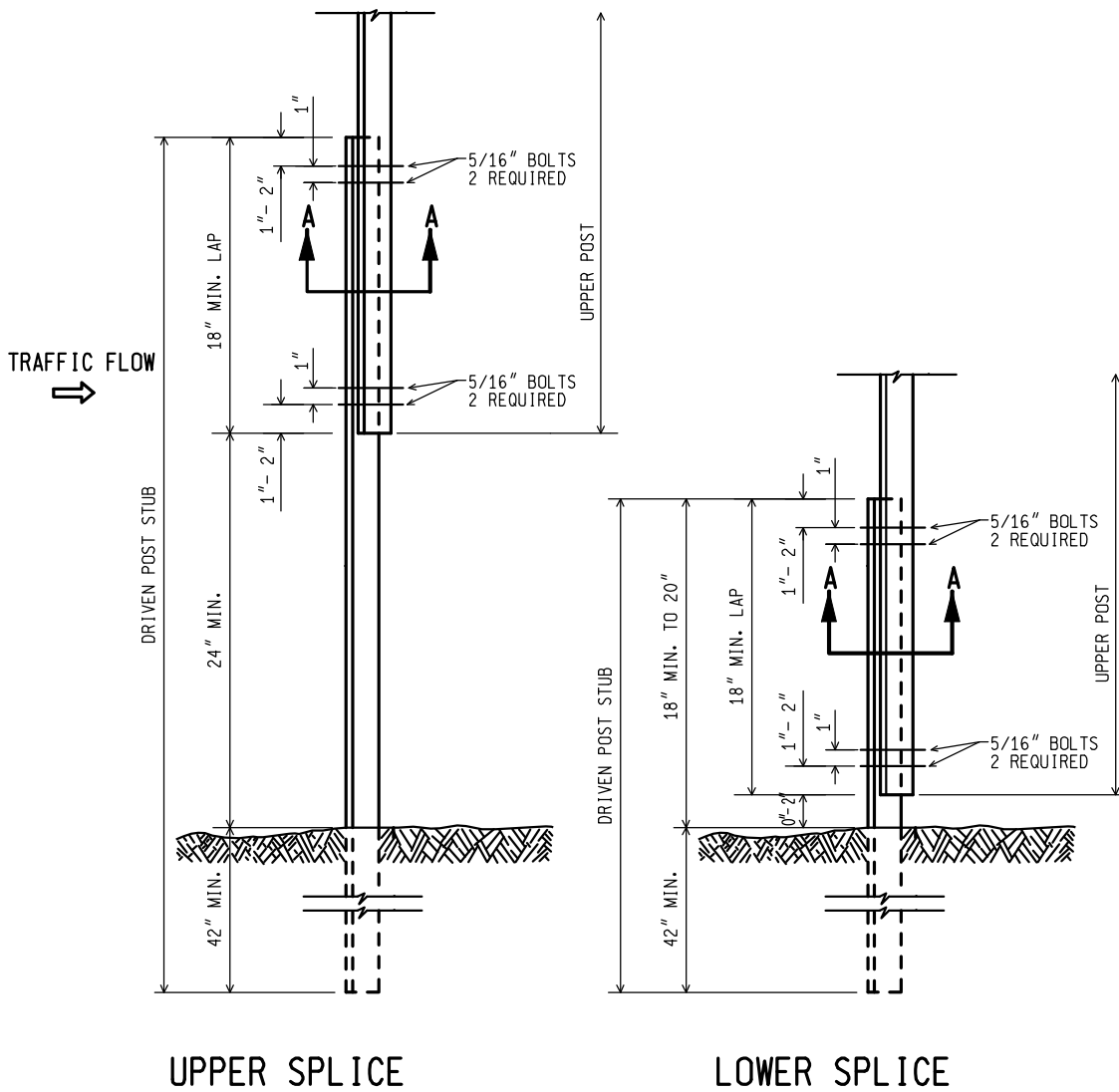

**3 lb. U - CHANNEL STEEL POST
(WITH SPLICE)**

MOUNT SIGN ON OPEN FACE OF
UPPER U - CHANNEL STEEL POST

NOT TO SCALE

MICHIGAN DEPARTMENT OF TRANSPORTATION
BUREAU OF HIGHWAYS DELIVERY STANDARD PLAN

PENDING
FHWA APPROVAL DATE

8/2006
PLAN DATE

WZD-100-A

SHEET
5 of 11

File:PW/Doc/RD/T&S/Typ/Dev/Sign MainTraf D/WZD-100-A Rev. 8/21/06 ECH

NOTE: THE ORIGINAL SIGNED COPY IS KEPT ON FILE AT THE MICHIGAN DEPARTMENT OF TRANSPORTATION.

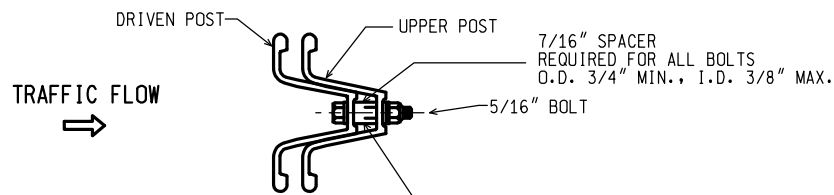

SECTION A-A

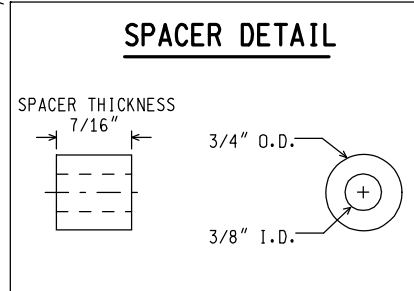

NOTES:

1. THE SPACER THICKNESS SHALL BE 1/16" LESS THAN THE GAP BETWEEN THE POST WHEN POSITIONED IN THE UNBOLTED CONFIGURATION.
2. THE EXTERIOR BOLT (CLOSEST TO LAP), SPACER, WASHER, AND NUT SHALL BE INSTALLED IN A PREPUNCHED HOLE 1" to 2" FROM THE END OF THE LAP.
3. THE INTERIOR BOLT (FARTHEST FROM LAP), SPACER, WASHER, AND NUT SHALL BE INSTALLED IN THE NEXT PREPUNCHED HOLE.
4. THE DRIVEN POST SHALL ALWAYS BE MOUNTED IN FRONT OF THE UPPER POST WITH RESPECT TO THE ADJACENT ONCOMING TRAFFIC, REGARDLESS OF THE DIRECTION THE SIGN IS FACING.
5. THE SPLICE LAP SHALL BE FASTENED BY FOUR-5/16" DIA. GALVANIZED A449 BOLTS (SAE J429 GRADE 5) OR GALVANIZED A325 BOLTS.

3 lb. U - CHANNEL STEEL POST
(WITH SPLICE)

NOT TO SCALE

MICHIGAN DEPARTMENT OF TRANSPORTATION BUREAU OF HIGHWAYS DELIVERY STANDARD PLAN	PENDING	8/2006	WZD-100-A	SHEET 6 of 11
	FHWA APPROVAL DATE			

NOTE: THE ORIGINAL SIGNED COPY IS KEPT ON FILE AT THE MICHIGAN DEPARTMENT OF TRANSPORTATION.

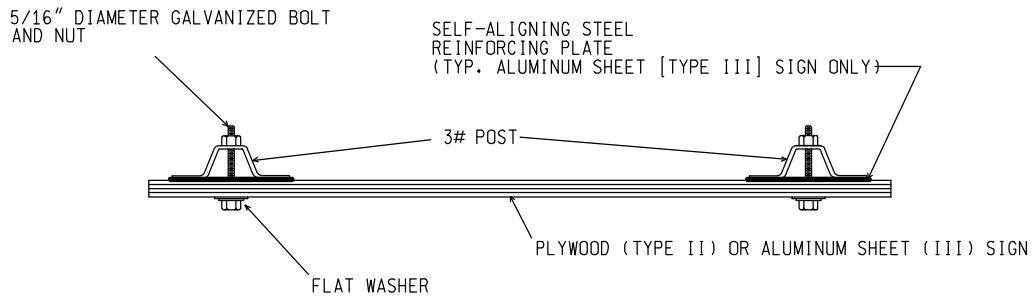

SIGN TO 3 lb. POST CONNECTION

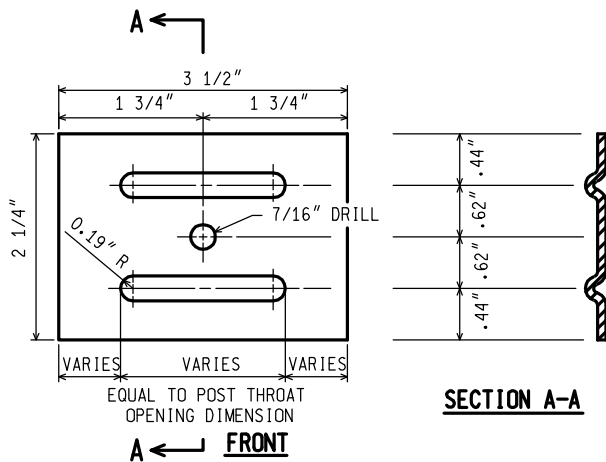

NOTES: (FOR STEEL SIGN REINF' PLATE)

1. MATERIAL: 12 GAUGE CARBON STEEL.
2. TOLERANCE ON ALL DIMENSIONS $\pm 0.0625"$
3. FINISH-AFTER STAMPING AND PUNCHING, GALVANIZE ACCORDING TO CURRENT SPECIFICATIONS FOR ZINC (HOT GALVANIZE) COATINGS ON PRODUCTS FABRICATED FROM PLATES OR STRIPS

STEEL SIGN REINFORCING PLATE
REQUIRED FOR TYPE III SIGNS ONLY

3 lb. U - CHANNEL STEEL POST SIGN CONNECTION

NOT TO SCALE

MICHIGAN DEPARTMENT OF TRANSPORTATION BUREAU OF HIGHWAYS DELIVERY STANDARD PLAN	PENDING FHWA APPROVAL DATE	8/2006 PLAN DATE	WZD-100-A	SHEET 7 of 11
File:PW/Doc/RD/T&S/Typ/Dev/Sign MainTraf D/WZD-100-A Rev. 8/21/06 ECH				

NOTE: THE ORIGINAL SIGNED COPY IS KEPT ON FILE AT THE MICHIGAN DEPARTMENT OF TRANSPORTATION.

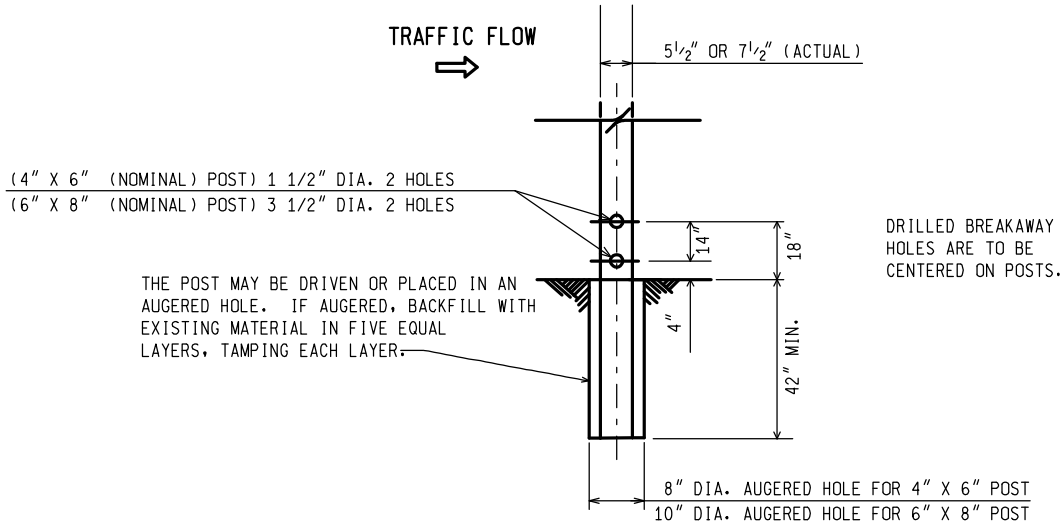

**WOOD POST BREAKAWAY HOLES/
 DIRECT EMBEDMENT DETAILS**

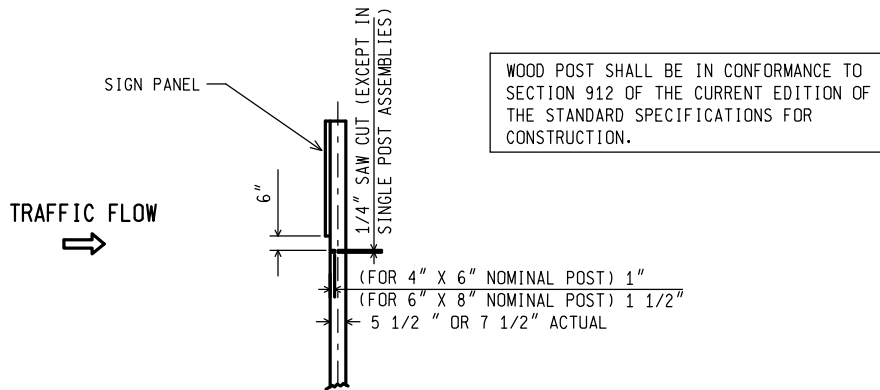

**SAW CUT DETAIL
 (MULTIPLE POST INSTALLATIONS)**

WOOD POST DETAILS

NOT TO SCALE

MICHIGAN DEPARTMENT OF TRANSPORTATION
 BUREAU OF HIGHWAYS DELIVERY STANDARD PLAN

PENDING
 FHWA APPROVAL DATE

8/2006
 PLAN DATE

WZD-100-A

SHEET
 8 of 11

File:PW/Doc/RD/T&S/Typ/Dev/Sign MainTraf D/WZD-100-A Rev. 8/21/06 ECH

NOTE: THE ORIGINAL SIGNED COPY IS KEPT ON FILE AT THE MICHIGAN DEPARTMENT OF TRANSPORTATION.

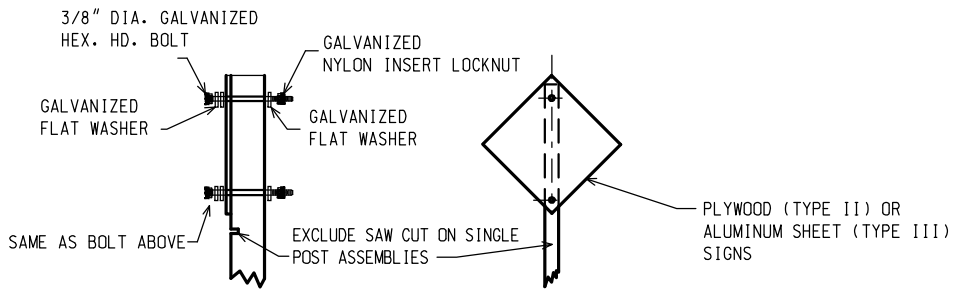

TYPE II AND TYPE III SIGNS

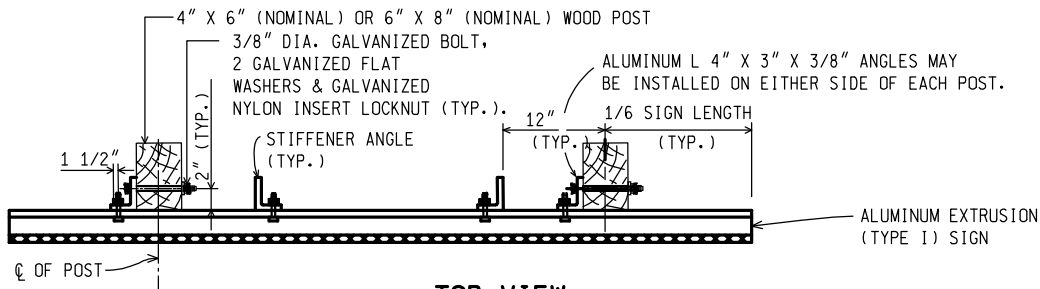

**TOP VIEW
TYPE I SIGN**

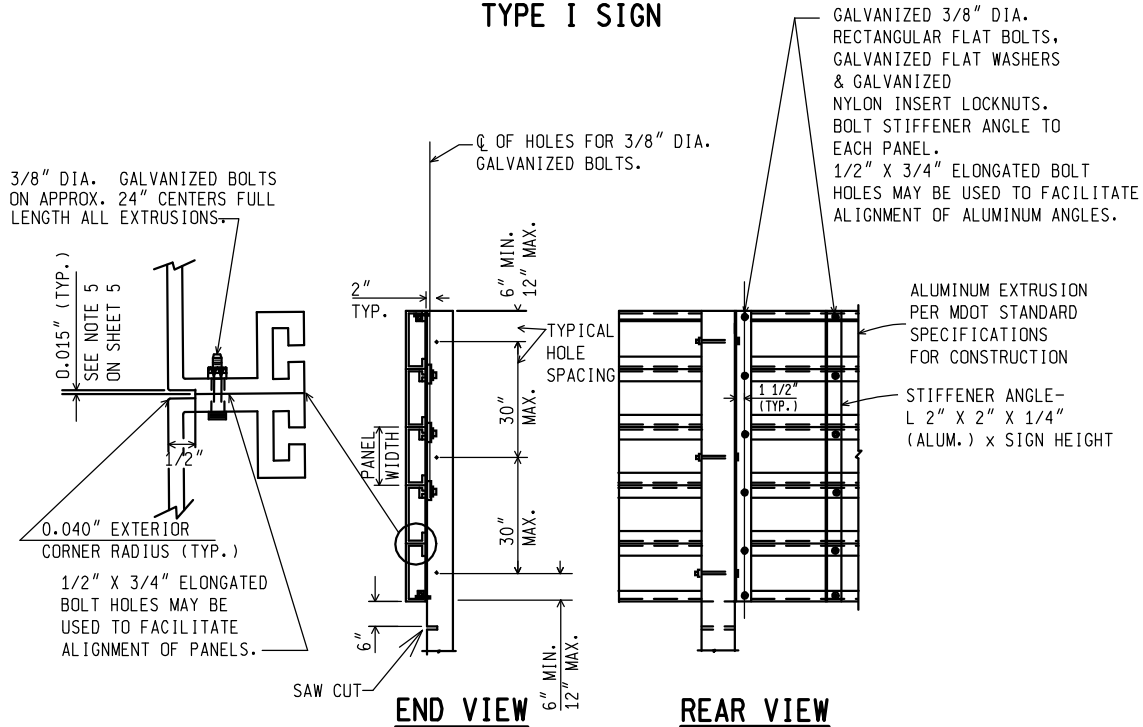

TYPE I SIGN - ERECTION DETAILS

WOOD POST CONNECTIONS

NOT TO SCALE

MICHIGAN DEPARTMENT OF TRANSPORTATION
BUREAU OF HIGHWAYS DELIVERY STANDARD PLAN

PENDING
FHWA APPROVAL DATE

8/2006

WZD-100-A

SHEET
9 of 11

File:PW/Doc/RD/T&S/Typ/Dev/Sign MainTraf D/WZD-100-A Rev. 8/21/06 ECH

PLAN DATE

NOTE: THE ORIGINAL SIGNED COPY IS KEPT ON FILE AT THE MICHIGAN DEPARTMENT OF TRANSPORTATION.

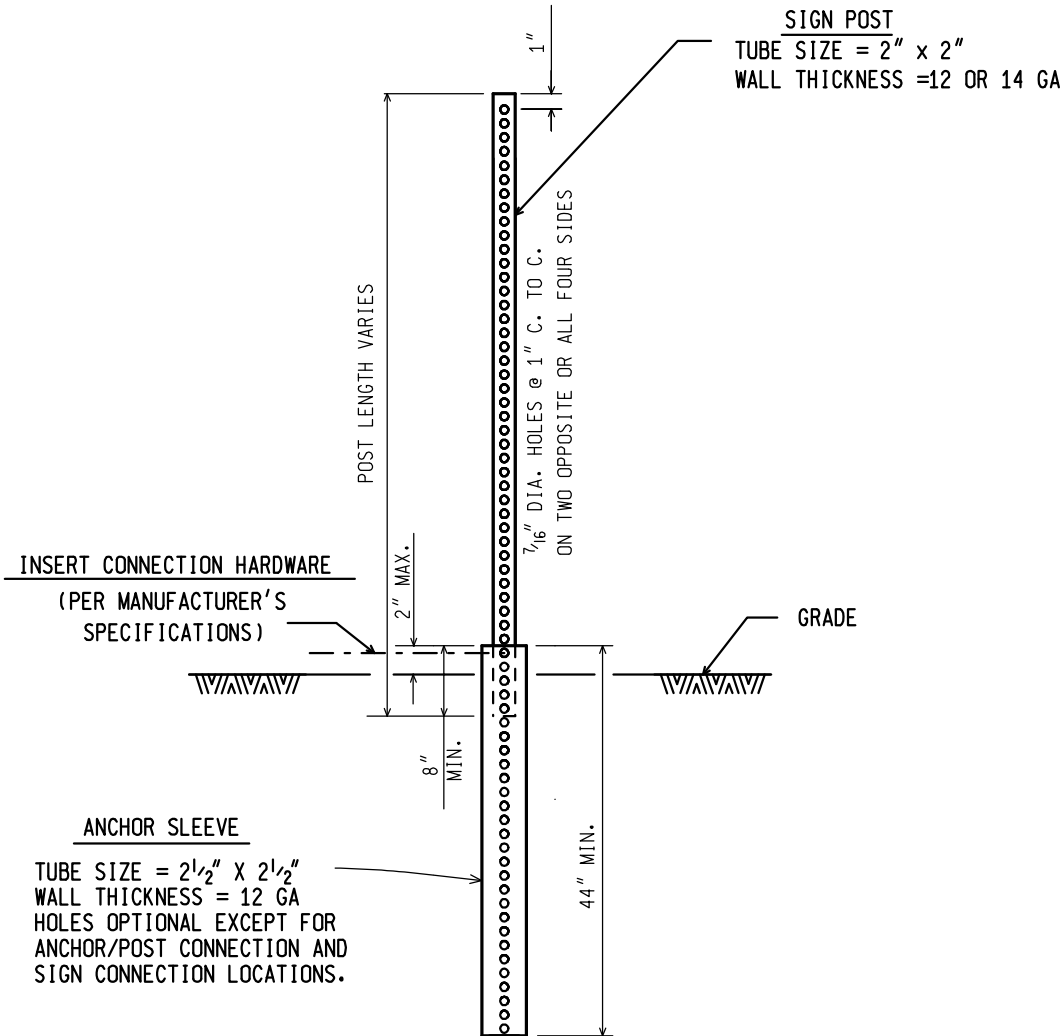

SQUARE TUBULAR STEEL POST

NOT TO SCALE

MICHIGAN DEPARTMENT OF TRANSPORTATION
 BUREAU OF HIGHWAYS DELIVERY STANDARD PLAN

PENDING
 FHWA APPROVAL DATE

8/2006
 PLAN DATE

WZD-100-A

SHEET
 10 of 11

File:PW/Doc/RD/T&S/Typ/Dev/Sign MainTraf D/WZD-100-A Rev. 8/21/06 ECH

NOTE: THE ORIGINAL SIGNED COPY IS KEPT ON FILE AT THE MICHIGAN DEPARTMENT OF TRANSPORTATION.

GENERAL NOTES:

1. A MAXIMUM OF TWO POSTS WITHIN A 7 FOOT PATH IS PERMITTED.
2. ALL SIGN POSTS SHALL COMPLY WITH NCHRP 350.
3. ALL POSTS SHALL BE EMBEDDED A MINIMUM OF 42".
4. BRACING OF POST IS NOT PERMITTED.
5. SIGN SHALL BE LEVEL, AND UPRIGHT FOR THE DURATION OF INSTALLATION.
6. ERECT POSTS SO THE SIGN FACE AND SUPPORTS DO NOT VARY FROM PLUMB BY MORE THAN 3/16" IN 3'. PROVIDE A CENTER-TO-CENTER DISTANCE BETWEEN POSTS WITHIN 2 PERCENT OF PLAN DISTANCE.
7. NO MORE THAN ONE SPLICE PER POST, AS SHOWN, WILL BE PERMITTED.
8. POST TYPES SHALL NOT BE MIXED WITHIN A SIGN SUPPORT INSTALLATION.
9. NO VERTICAL JOINTS ARE PERMITTED IN SIGN. NO HORIZONTAL JOINTS THROUGH SIGN LEGEND OR SYMBOLS ARE PERMITTED IN SIGN
10. REMOVE SIGN POSTS AND/OR POST STUBS IN THEIR ENTIRETY WHEN NO LONGER REQUIRED.
11. ALL LABOR, MATERIALS, AND EQUIPMENT, INCLUDING TEMPORARY SUPPORTS REQUIRED TO INSTALL, MAINTAIN, RELOCATE, COVER, AND/OR REMOVE THE TEMPORARY SIGN, INCLUDING SUPPORTS, ARE CONSIDERED TO BE INCLUDED IN THE COST OF THE TEMPORARY SIGN.
12. SAW CUTS IN WOOD POSTS ARE TO BE PARALLEL TO THE BOTTOM OF THE SIGN.
13. POSTS SHALL NOT EXTEND MORE THAN 4" ABOVE TOP OF SIGN.

NOT TO SCALE

MICHIGAN DEPARTMENT OF TRANSPORTATION BUREAU OF HIGHWAYS DELIVERY STANDARD PLAN	PENDING FHWA APPROVAL DATE	8/2006 PLAN DATE	WZD-100-A	SHEET 11 of 11
File:PW/Doc/RD/T&S/Typ/Dev/Sign MainTraf D/WZD-100-A Rev. 8/21/06 ECH				

NOTE: THE ORIGINAL SIGNED COPY IS KEPT ON FILE AT THE MICHIGAN DEPARTMENT OF TRANSPORTATION.

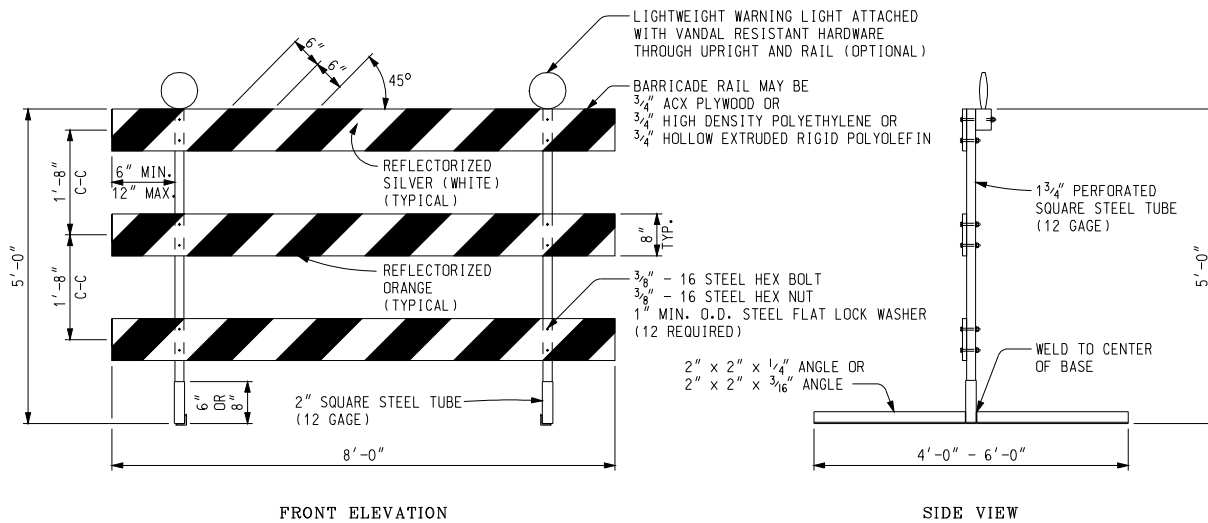

PERFORATED SQUARE STEEL TUBE OPTION

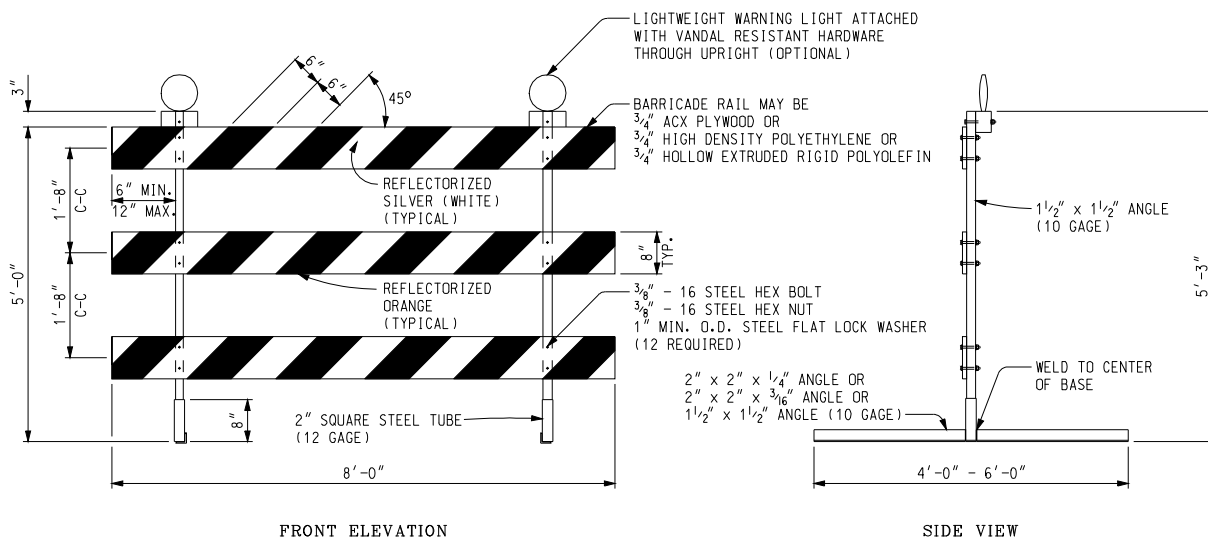

ANGLE IRON OPTION

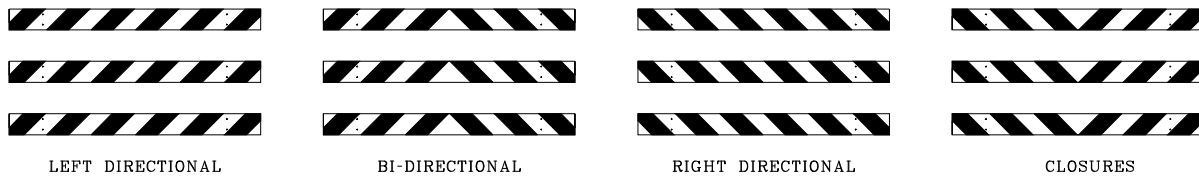

BARRICADE RAIL SHEETING OPTIONS
TYPE III BARRICADES

Other Type III Barricades meeting current NCHRP crash worthy criteria can be found on the FHWA Safety website at

http://safety.fhwa.dot.gov/roadway_dept/road_hardware/wzd.htm

NOT TO SCALE

File: T&S/Typ/Signs/WorkZones/wzd 125 d

Rev. 09/22/09 PJ



PREPARED BY
TRAFFIC AND SAFETY

DRAWN BY: ECH

CHECKED BY: MWB

ENGINEER OF DELIVERY

ENGINEER OF DEVELOPMENT

(SPECIAL DETAIL)

FHWA APPROVAL DATE

MICHIGAN DEPARTMENT OF TRANSPORTATION
BUREAU OF HIGHWAYS DELIVERY STANDARD PLAN FOR

Temporary
Traffic Control Devices

9/22/09
PLAN DATE

WZD-125-E

SHEET
1 of 3

NOTE: THE ORIGINAL SIGNED COPY IS KEPT ON FILE AT THE MICHIGAN DEPARTMENT OF TRANSPORTATION.

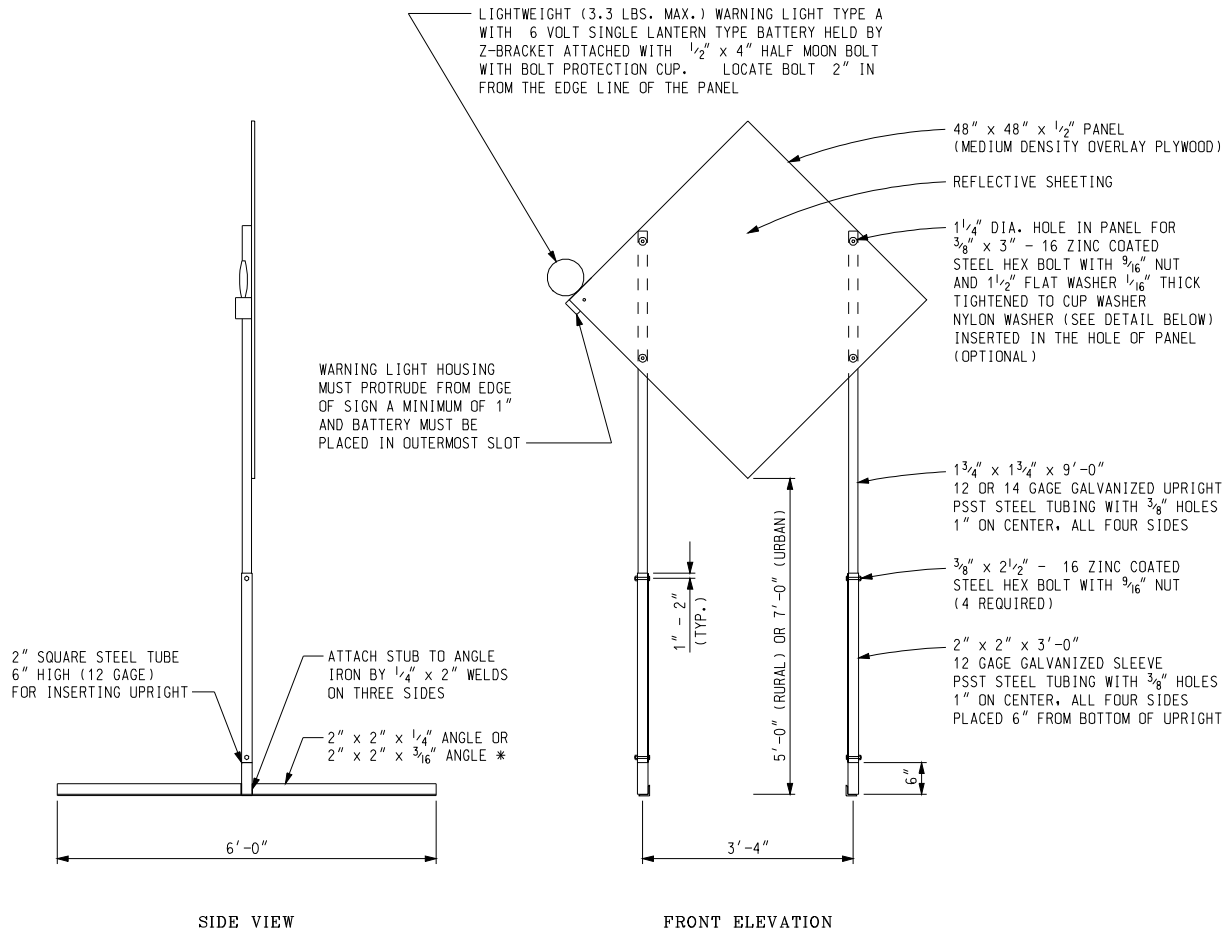

TEMPORARY SIGN SUPPORT

(WARNING LIGHT PLACED ON SIDE CLOSEST TO TRAFFIC)

* SIGN STAND IS BALLASTED WITH FOUR OR MORE 35 LB SANDBAGS. A MINIMUM OF ONE ON EACH END.
 UPRIGHTS SHALL NOT EXTEND ABOVE THE SIGN PANEL.

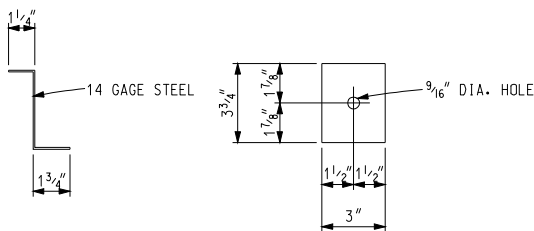

Z-BRACKET DETAIL

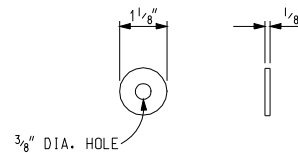

OPTIONAL NYLON WASHER

Other temporary sign supports meeting current NCHRP crash worthy criteria can be found on the FHWA Safety website at http://safety.fhwa.dot.gov/roadway_dept/road_hardware/wzd.htm

NOT TO SCALE

MICHIGAN DEPARTMENT OF TRANSPORTATION BUREAU OF HIGHWAYS DELIVERY STANDARD PLAN	(SPECIAL DETAIL) FHWA APPROVAL DATE	9/22/09	WZD-125-E	SHEET 2 of 3
File: T&S/Typ/Signs/WorkZones/wzd 125 d	Rev. 09/22/09 PJ	PLAN DATE		

NOTE: THE ORIGINAL SIGNED COPY IS KEPT ON FILE AT THE MICHIGAN DEPARTMENT OF TRANSPORTATION.

- PLASTIC DRUM
- ▲▲▲ PROPOSED TYPE III BARRICADE
- △△△ EXISTING TYPE III BARRICADE

SYMBOLS TO BE USED ON PLANS

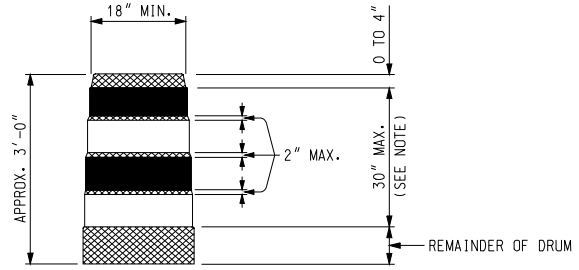

- REFLECTORIZED ORANGE
- REFLECTORIZED WHITE
- ▨ NON REFLECTORIZED ORANGE

NOTE:
 DRUMS SHALL HAVE AT LEAST 4 HORIZONTAL REFLECTORIZED STRIPES (2 ORANGE AND 2 WHITE) OF 6" UNIFORM WIDTH, ALTERNATING IN COLOR WITH THE TOPMOST REFLECTORIZED STRIPE BEING ORANGE. NON REFLECTORIZED SPACES BETWEEN THE HORIZONTAL REFLECTORIZED ORANGE AND WHITE STRIPES SHALL BE ORANGE IN COLOR AND EQUAL IN WIDTH.

PLASTIC DRUM

NOTES:

2" PERFORATED SQUARE STEEL TUBES MAY BE USED TO FABRICATE THE HORIZONTAL BASE OF THE TYPE III BARRICADE.

WARNING LIGHTS SHALL BE PLACED ACCORDING TO THE CURRENT STANDARD SPECIFICATIONS FOR CONSTRUCTION AND ALL OTHER PROVISIONS IN THE CONTRACT WHEN THEY ARE USED ON TYPE III BARRICADES.

SEE ROAD STANDARD PLANS R-113-SERIES FOR TEMPORARY CROSSOVERS FOR DIVIDED ROADWAY, AND R-126-SERIES FOR TYPICAL LOCATION AND SPACING OF PLASTIC DRUMS FOR PLACEMENT OF TEMPORARY CONCRETE BARRIER.

SIGNS, BARRICADES, AND PLASTIC DRUMS SHALL BE FACED WITH PRESSURE-SENSITIVE REFLECTIVE SHEETING ACCORDING TO THE CURRENT STANDARD SPECIFICATIONS FOR CONSTRUCTION.

SANDBAGS SHALL BE USED WHEN SUPPLEMENTAL WEIGHTS ARE REQUIRED TO ACHIEVE STABILITY OF THE BARRICADE. THE SANDBAGS SHALL BE PLACED SO THEY WILL NOT COVER OR OBSTRUCT ANY REFLECTIVE PORTION OF THE TRAFFIC CONTROL DEVICE.

NOT TO SCALE

MICHIGAN DEPARTMENT OF TRANSPORTATION BUREAU OF HIGHWAYS DELIVERY STANDARD PLAN	(SPECIAL DETAIL) FHWA APPROVAL DATE	9/22/09	WZD-125-E	SHEET 3 of 3
File: T&S/Typ/Signs/WorkZones/wzd 125 d	Rev. 09/22/09 PJ	PLAN DATE		

NOTE: THE ORIGINAL SIGNED COPY IS KEPT ON FILE AT THE MICHIGAN DEPARTMENT OF TRANSPORTATION.

CITY OF ANN ARBOR
DETAILED SPECIFICATION
FOR
MINOR TRAFFIC CONTROL

AA:DAD

1 of 4

04/05/15

a. Description. This work shall consist of protecting and maintaining vehicular and pedestrian traffic, in accordance with the City of Ann Arbor Standard Specifications for Construction sections 104.11 and 812 of the Michigan Department of Transportation (MDOT) 2012 Standard Specifications for Construction; Part 6 of the 2011 Edition of the Michigan Manual of Uniform Traffic Control Devices (MMUTCD); and, except as modified herein.

The work shall include, but is not limited to the following:

- The furnishing and operating of miscellaneous signs, warning devices, flags, and cones;
- The operation of additional signs furnished by the City;
- Furnishing and installing meter bags;
- Coordinating with the City to have meter heads removed and reinstalled;
- Maintaining pedestrian traffic;
- Temporarily covering traffic controls;
- Temporarily covering existing signs as directed;
- Any and all other miscellaneous and/or incidental items which are necessary to properly perform the work.

b. Materials. Materials and equipment shall meet the requirements specified in section 812 of the MDOT 2012 Standard Specifications for Construction.

c. Construction. The Contractor shall maintain pedestrian traffic at all times. For maintaining normal pedestrian traffic while performing sidewalk and driveway repair, Plastic Drum, High Intensity, Lighted shall be placed by the Contractor as directed by the Engineer. The Contractor, when directed by the Engineer, shall place "Sidewalk Closed" and/or "Cross Here" signs and the cost shall be included in this pay item and will not be paid for separately.

All temporary traffic/pedestrian control devices furnished by the Contractor shall remain the property of the Contractor. The City shall not be responsible for stolen or damaged signs, barricades, barricade lights or other traffic maintenance items. The Contractor shall replace missing traffic control devices immediately, at no additional cost to the Contractor or City. All existing signs, and signs erected by the City of Ann Arbor on this project shall be preserved, protected, and maintained by the Contractor. The City will repair any existing City owned signs, at the Contractor's expense, which are damaged by the Contractor during the work.

The Contractor shall temporarily cover conflicting traffic and/or parking signs when directed by the Engineer.

Parking violation citations issued to the Contractor, subcontractor, and material suppliers including each of their respective employees shall be enforced under appropriate City Code.

The work shall include: furnishing and operating of miscellaneous signs and warning devices; furnishing cones; operating additional signs furnished by the City throughout the life of the Contract; furnishing and operating pedestrian traffic control devices; maintaining a safe trench during all non-working hours; maintaining access to all drives; covering conflicting existing signs and removal of these covers; and any and all other miscellaneous and/or incidental items which are necessary to properly perform the work.

Where there is metered parking, the Contractor shall either rent and install meter bags, or, with the Engineer's authorization, coordinate with the City Field Operation Services to have meter heads removed and reinstalled.

The Contractor shall maintain vehicular and pedestrian traffic during the work by the use of traffic regulators, channelizing devices and signs as necessary, as directed by the Engineer, and in accordance with 2011 Edition of the MMUTCD. Typical applications for maintaining pedestrian traffic in accordance with the 2011 Edition of the MMUTCD are included in this detailed specification.

In order to maintain areas of on-street parking available for residents, the Engineer may direct the contractor to cover and uncover temporary "No Parking" signs within the project limits multiple times throughout the course of the project. Such repeated covering and uncovering of signs shall be included in this item of work and shall not be paid for separately.

d. Measurement and Payment. The completed work, as described, will be measured and paid for at the contract unit price for the following pay item:

<u>Pay Item</u>	<u>Pay Unit</u>
Minor Traffic Control, Max \$7,500	Lump Sum

The unit price for this item of work shall include all labor, material, and equipment costs to perform all the work described by this Detailed Specification.

Costs for transporting barricades and other temporary traffic control devices shall be included in the bid prices for the individual items of work.

This item will be paid for on a pro rata basis with each progress payment. Measurement will be based on the ratio between work completed during the payment period and the total contract amount. When all of the work of this Contract has been completed, the measurement of this item shall be 1.0 Lump Sum minus any deductions incurred for inadequate performance as described herein. This amount will not be increased for any reason, including extensions of time, extras, and/or additional work.



Figure 6H-28. Sidewalk Detour or Diversion (TA-28)

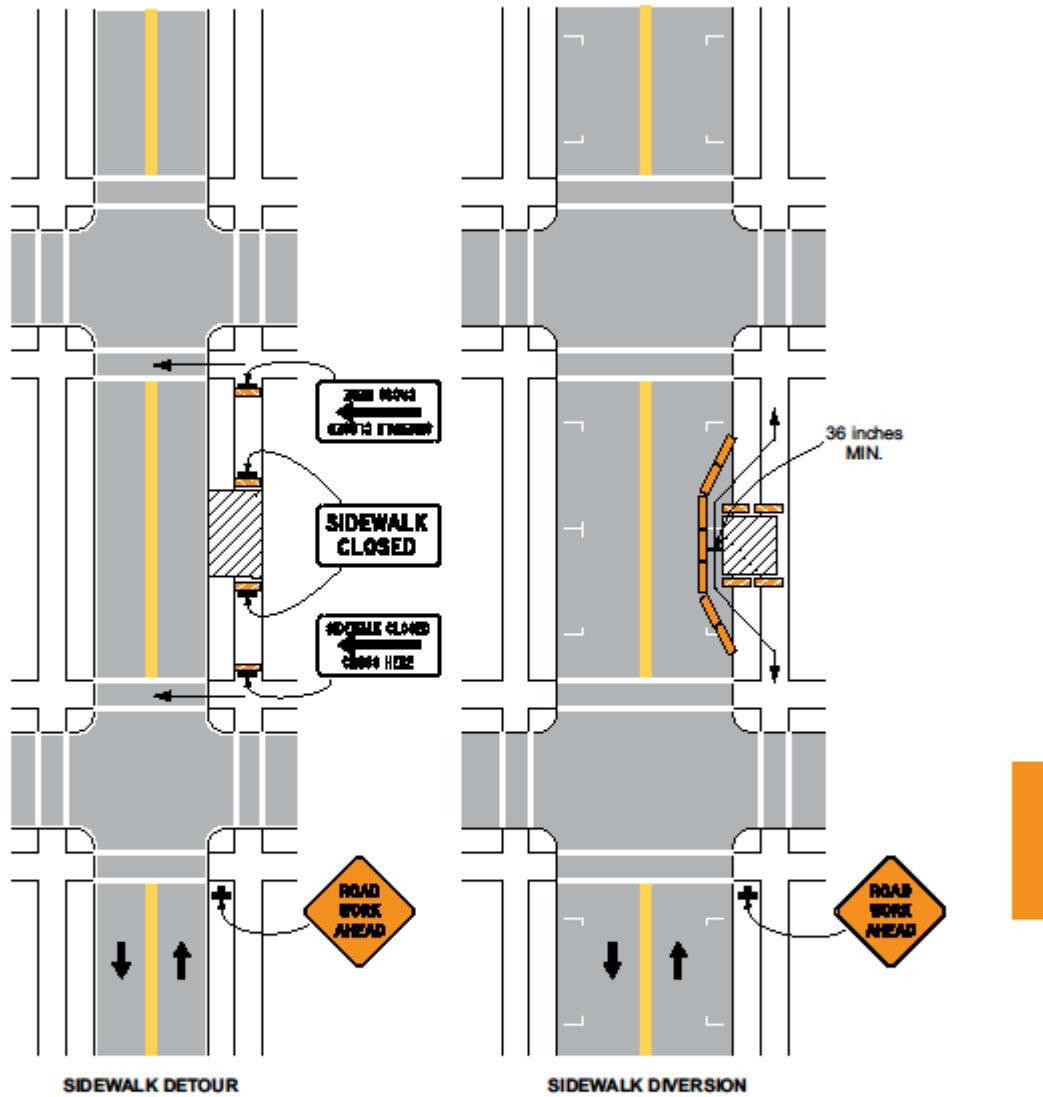

Typical Application 28

Note: See Tables 6H-2 and 6H-3 for the meaning of the symbols and/or letter codes used in this figure.

Figure 6H-29. Crosswalk Closures and Pedestrian Detours (TA-29)

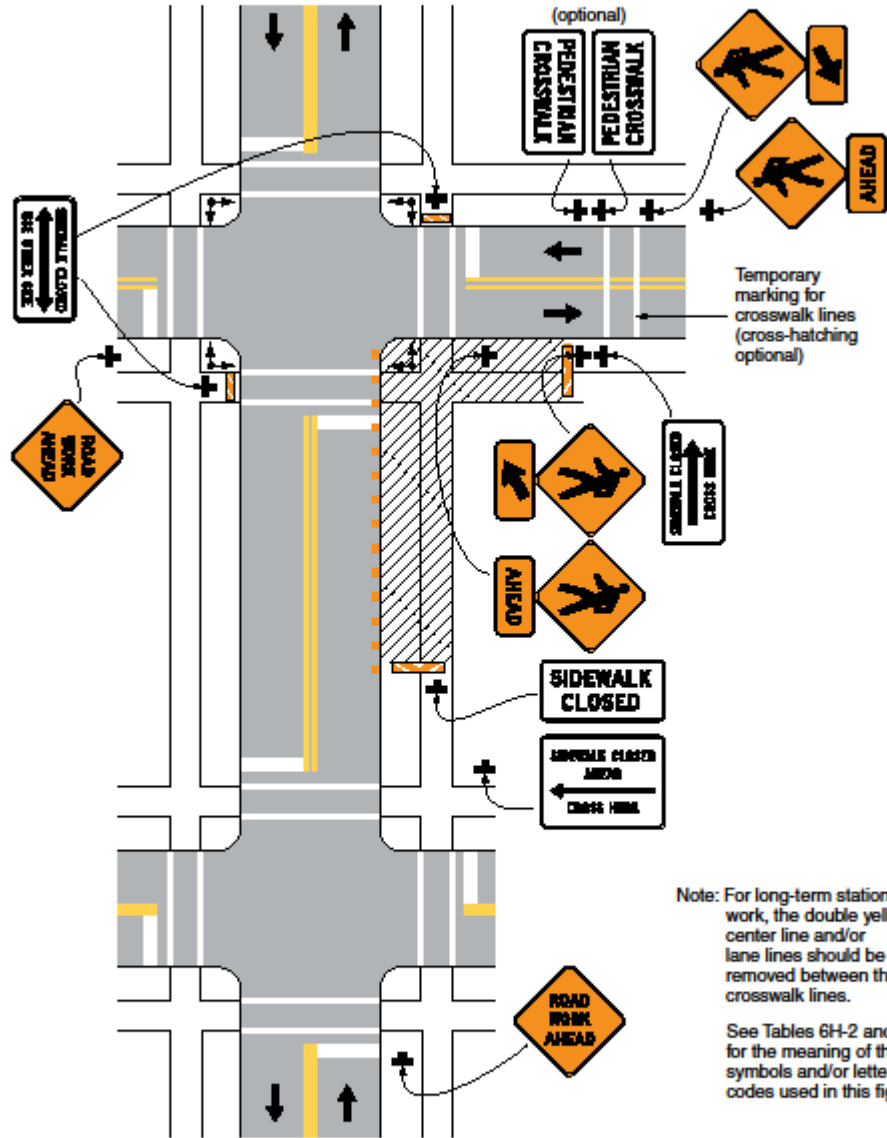

Typical Application 29

CITY OF ANN ARBOR

DETAILED SPECIFICATION
FOR
NO PARKING SIGNS

AA:DAD

1 of 1

04/05/15

a. Description. This work shall consist of installing, maintaining and removing of "No Parking" signs and posts as outlined herein and as referenced on the plans. "No Parking" signs shall be installed in accordance with the section 812 of the Michigan Department of Transportation (MDOT) 2012 Standard Specifications for Construction Standard Specifications and the 2011 Michigan Manual of Uniform Traffic Control Devices (MMUTCD).

b. Materials. The City will furnish "No Parking" signs to the Contractor at no cost. The Contractor shall furnish the sign support and mounting hardware materials, which materials shall be in accordance with those specified in section 919 of the MDOT 2012 Standard Specifications for Construction.

c. Construction. Prior to the commencement of any construction activity, the Contractor shall place "No Parking" signs as directed by the Engineer. The Contractor shall obtain a permit for "Temporary Permission of Reserve Parking Lane for Work Related Purposes" from the City's Project Management Services Unit. This permit shall be obtained a minimum of 5 business days prior to the posting of "No Parking" signs.

The Contractor shall securely bolt the signs to the sign supports as directed by the Engineer. The Contractor shall imbed the sign supports at least two feet into the ground, and there shall be a minimum of six feet and maximum of seven feet of clearance maintained between the bottom of the sign and the ground. The signs are to be placed at intervals no more than 75 feet, and as necessary to eliminate parking in the construction area.

The installation of "No Parking" signs shall be in accordance with the permit. "No Parking" signs shall be installed by the Contractor, as directed by the Engineer, at least 48 hours prior to the proposed start-of-work/enforcement date. "No Parking" signs shall be covered by the Contractor, thereby allowing on-street parking, until between 48 and 24 hours prior to the start of the work. "No Parking" signs shall be covered by the Contractor whenever there is no work being performed for a period of time longer than 72 hours. "No Parking" signs shall be returned to the City upon the completion of work. The cost of unreturned signs will be back charged to the Contractor.

d. Measurement and Payment. The completed work, as described, will be measured and paid for at the contract unit price for the following pay item:

<u>Pay Item</u>	<u>Pay Unit</u>
No Parking Sign	Each

The item **No Parking Sign** will be measured as the maximum number of signs installed on the project at any one time. The unit price includes the removal and return of "No Parking" signs to the City upon completion of the project. The Contractor shall be back charged for the replacement costs for damaged or unreturned signs.

CITY OF ANN ARBOR
 DETAILED SPECIFICATION
 FOR
PROTECTING AND PRESERVING IRRIGATION SYSTEMS

AA:DAD

1 of 1

04/06/15

a. Description. This work shall consist of all labor, materials, and equipment necessary to investigate, locate, save and protect from damage, ensure continued and proper operation during the performance of the project work, re-establish operation as necessary, and upon completion of all project work, ensure that all existing sprinkler systems located within the project limits, or those affected by the project, are functioning in a satisfactory manner as determined by the Engineer.

b. Materials. None specified.

c. Construction. The Contractor shall be aware that properties located within the project limits have underground sprinkler systems that irrigate both private property and portions of the public right-of-way. The irrigation systems have been installed by a variety of private installers and may utilize several different materials and/or suppliers of the various components. Portions of the existing irrigation systems have been installed under paved areas, extend into landscaped islands, or may be required to be located within such areas at the conclusion of the project's construction.

The contractor shall perform the necessary investigations to determine the precise location of the irrigation systems, and all affected components, prior to the commencement of construction operations, determine all impacts to the systems that will result pursuant to the project's construction, and take the needed actions to ensure that the sprinkler systems will remain functional during the project's construction, and will be re-established in such a manner at appropriate intermediate and final project milestones, that the original functionality of the system is maintained to the greatest extent possible.

The Contractor shall contact all property owners prior to the commencement of the work in order to determine the impacts to their irrigation systems and coordinate the project's work with them to ensure satisfactory operation of the irrigation systems during construction.

All work shall be approved by the Engineer and the affected property owner(s) at the conclusion of the project's work.

d. Measurement and Payment. The completed work, as described, will be measured and paid for at the contract unit price for the following pay item:

<u>Contract Item (Pay Item)</u>	<u>Pay Unit</u>
Irrigation System, Protection and Maintenance	Lump Sum

The unit price for this item shall include all labor, material, and equipment costs required to complete the work.

CITY OF ANN ARBOR
DETAILED SPECIFICATION
FOR
SLOPE RESTORATION

AA:DAD

1 of 2

04/05/15

a. Description. This work consists of preparing all manicured lawns and slopes on non-freeway projects designated for slope restoration on the plans or by the Engineer, and applying topsoil, fertilizer, seed, and mulch to those areas. Turf establishment shall be in accordance with section 816 of the Michigan Department of Transportation (MDOT) 2012 Standard Specifications for Construction and Standard Plan Series R-100, except as modified herein or otherwise directed by the Engineer.

b. Materials. The materials and application rates specified in sections 816 and 917 of the MDOT 2012 Standard Specifications for Construction apply unless modified by this special provision or otherwise directed by the Engineer.

1. Topsoil Surface: Place **4 inches** of topsoil in area disturbed areas to be restored. Topsoil shall be free of all stones one inch in diameter or greater.
2. Turf Seed Mixture: Use seed mixture type THM (Turf Loamy to Heavy).
3. Chemical Fertilizer Nutrient: Use Class A fertilizer.
4. Use Mulch Blankets on all areas to be restored.

c. Construction. Construction methods shall be in accordance to subsection 816.03 of the MDOT 2012 Standard Specifications for Construction. Begin this work as soon as possible after final grading of the areas designated for slope restoration but no later than the maximum time frames stated in subsection 208.03 of the Standard Specifications for Construction. It may be necessary, as directed by the Engineer, to place materials by hand.

Prior to placing topsoil, shape, compact and assure all areas to be seeded **are weed free**. Place topsoil to the minimum depth indicated above, to meet proposed finished grade. Remove any stones greater than or equal to 1 inch in diameter. If the area being restored requires more than the minimum depth of topsoil to meet finished grade, this additional depth must be filled using topsoil. Furnishing and placing this additional material is included in this item of work.

Topsoil shall be **weed and weed seed free** and friable prior to placing seed. Remove all stones from the topsoil greater than 1 inch in diameter. Apply seed mixture and fertilizer to prepared soil surface. Seed shall be incorporated into top ½ inch of topsoil.

If an area washes out after this work has been properly completed and approved by the Engineer, make the required corrections to prevent future washouts and replace the topsoil, fertilizer, seed and mulch. This replacement will be paid for as additional work using the applicable contract items.

If an area washes out for reasons attributable to the Contractor's activity or failure to take proper precautions, replacement shall be at the Contractor's expense.

The Engineer will inspect the seeded turf to ensure the end product is well established, weed free, in a vigorous growing condition, and contains the species called for in the seeding mixture. **If areas do not promote growth, the Contractor shall apply new seed at its expense.**

If weeds are determined by the Engineer to cover more than ten percent of the total area of slope restoration, the Contractor shall provide weed control in accordance to subsection 816.03.J of the MDOT 2012 Standard Specifications for Construction. Weed control shall be at the Contractor's expense with no additional charges to the project for materials, labor or equipment.

d. Measurement and Payment. The completed work, as described, will be measured and paid for at the contract unit price for the following pay item:

<u>Pay Item</u>	<u>Pay Unit</u>
Slope Restoration	Square Yard

Slope Restoration shall be performed in all areas disturbed by the Contractor to construct the Project as shown on the plans and as directed by the Engineer. The Contractor will restore areas disturbed by its operations not required by the Project at its own expense.

SPECIAL PROVISION
FOR
ELECTRICAL AND COMMUNICATION HANDHOLES

AA:JN

1 of 2

02/10/14

a. Description.- This work shall consist of furnishing and installing traffic signal handholes and communication handhole assemblies at the locations shown in the Plans, or as directed by the Engineer. All work shall be completed in accordance with the current National Electric Code (NEC), Section 819 of the Michigan Department of Transportation 2012 Standard Specifications for Construction, except as specified herein.

b. Materials.- All materials shall be new and meet the requirements of the current IEEE, NEMA, ANSI Standards as applicable, and as specified herein.

The Contractor shall submit product data sheets for all handholes, covers and other parts for Engineer approval prior to ordering materials. The manufacturer "Quazite Composolite," referenced below, is located in Lenoir City, Tennessee.

12 inch x 18 inch handhole assemblies shall consist of "Quazite Composolite" box. The box shall be #PG1118BA12. The cover shall be, #PG1118HA41, a locking heavy-duty bolt-down type with a logo that reads "Street Lighting." The total depth of the handhole shall be 12 inches.

17 inch x 30 inch handhole assemblies shall consist of two, stacked "Quazite Composolite" boxes. The lower box shall be #PG1730BB18. The upper box shall be #PG1730BA18. The cover shall be, #PG1730HA46, a locking heavy-duty bolt-down type with a logo that reads "Traffic Signal." The total depth of the handhole shall be 36 inches.

24 inch x 36 inch handhole assemblies shall consist of "Quazite Composolite" box. The box shall be #PG2436BA24. The cover shall be, # PG2436HA12, a locking heavy-duty bolt-down type with a logo that reads "Street Lighting." The total depth of the handhole shall be 24 inches.

Provide Granular Material, Class II as detailed elsewhere in these contract documents.

c. Methods of Construction.- Handholes shall be placed at all junctions of traffic signal or electrical conduit, and as shown on the plans. Maximum distance between any two handholes shall be as shown on the Plans, but in no case shall exceed 500 feet.

Place foundation material consisting of 4 inches of MDOT Class II sand compacted to 95% of its maximum unit weight.

Set the handhole or stacked units to the proper depth and elevation.

Connect handholes to new and existing conduits, whether shown on the plans or not. All conduits shall be connected to the handholes in accordance with the latest revision of Article 346 of the National Electrical Code (NEC).

Backfill around the perimeter of the handhole with MDOT Class II material compacted to 95% of its maximum unit weight.

d. Measurement and Payment.- The completed work shall be paid for at the contract unit

SPECIAL PROVISION
FOR
ELECTRICAL AND COMMUNICATION HANDHOLES

AA:JN

2 of 2

02/10/14

price for the following contract items (pay items):

<u>Contract Item (Pay Item)</u>	<u>Pay Unit</u>
Handhole Assembly, 12 inch x 18 inch	Each
Handhole Assembly, 17 inch x 30 inch	Each
Handhole Assembly, 24 inch x 36 inch	Each

Handhole Assembly, ___ inch x ___ inch shall be paid for at their contract unit prices and shall include all labor, equipment, and materials to complete the work as specified herein.

The pay item shall also include the excavation and disposal of materials, furnishing, installing and compacting MDOT Class II sand, and all work related to connecting handholes to new and existing conduits, whether shown on the plans or not.

CITY OF ANN ARBOR
DETAILED SPECIFICATION
FOR
SANITARY SEWER

AA:DAD

1 of 22

04/08/15

a. Description. This work includes installing sanitary sewer, manholes and related items. The Contractor shall furnish all materials, equipment, tools, and labor necessary to perform the work required by this special provision and shall unload, haul, distribute, store, and install all pipe, fittings, castings, manholes, and accessories.

The Contractor shall excavate all trenches and pits to the required dimensions; excavate the bell holes; sheet, brace, and properly support the adjoining ground or structures where necessary to comply with MIOSHA and other relevant safety standards; properly handle and remove all drainage or ground water so that the work can be completed in accordance with the specifications; install and test the pipe, fittings, castings, manholes, and accessories; backfill and compact all fill materials within trenches and pits; and remove and properly dispose of surplus or unsuitable excavated material off-site.

The MDEQ permit required to perform the sanitary sewer work shown on the plans is included in the proposal.

b. Materials. Materials shall conform to the following sections of Michigan Department of Transportation (MDOT) 2012 Standard Specifications for Construction.

Concrete, Grade S2	Section 701
Mortar, Type R-1	Section 702
Granular Material, Class II	Section 902
Coarse Aggregate, 6A	Section 902
Steel Reinforcement	Section 905
Castings	Section 908
Miscellaneous Metal Products	Section 908
Geosynthetics	Section 910
Masonry Units	Section 913

Coarse Aggregate, 6A shall be crushed limestone. Concrete, Grade X shall consist of Portland cement, coarse and fine aggregates, and water, proportioned with 282 lbs. cement (3 sacks) per cubic yard to produce a minimum 28 day compressive strength of 1000 psi.

1. Submittals. Prior to beginning construction, the Contractor shall submit the following:
 - A. Product data on all pipe, fittings, and manhole structures.
 - B. Manufacturer's certifications on all pipe, fittings, and manhole structures indicating that all materials meet the minimum requirements of these specifications.
 - C. Information on equipment and methods to be used for mandrel, air, infiltration, and exfiltration testing, and television inspection.

2. General Specifications.

A. Vitrified Clay Pipe and Fittings:

Vitrified clay sewer pipe shall be the bell and spigot type, glazed or non-glazed, and shall be of full internal diameter from 4 through 18 inches inclusive. Clay pipe shall conform to the material and testing requirements of ASTM C 700, extra strength.

Joints:

Joints for vitrified clay sewer pipe shall be compression type joints conforming to the material and testing requirements of ASTM C 425. Lubricant used in making up joints shall be supplied by the pipe manufacturer and the joints shall be coupled in accordance with the manufacturer's requirements.

(1) Pipe Marking:

The following information shall be clearly marked on each length of pipe:

- (a) The pipe designation and class (e.g., C 700, ES).
- (b) The name or trademark of the manufacturer.
- (c) Identification of the manufacturing plant.
- (d) Testing lot number or testing lab stamp.

(2) Manufacturer's Certification:

All pipe furnished shall be accompanied by the manufacturer's certificate of test showing conformity with the Specifications. Each certificate shall identify a specific lot number, quantity of pipe, and show actual test results for the lot furnished. These certificates shall be submitted to the Inspector at the time of unloading.

(3) Inspection:

All pipe furnished shall be subject to inspection on arrival at the job site by the Engineer. The purpose of the inspection shall be to cull and reject pipe or fittings that, independent of physical tests specified under the standard specifications designated herein, fail to conform to the requirements of these Specifications.

The Contractor shall notify the Engineer sufficiently in advance so that an Inspector may be on the job during the unloading of materials. A minimum notice of 24 hours is required for such unloading and inspection.

Vitrified clay pipe shall be subject to rejection on account of any of the following:

- (a) Variation in any dimension exceeding the permissible variations given in the material specifications. Pipe in all cases shall be full diameter.
- (b) Fractures or cracks passing through the barrel or socket.
- (c) Chips or fractures on the interior of the pipe exceeding two inches in length, one inch in width, or depth more than 1/4 of the thickness of the wall.

- (d) Blisters that are either broken, exceed three inches in diameter, or project more than 1/8-inch above the surrounding surface of the pipe.
- (e) Variation of more than 1/16-inch per lineal foot in alignment of pipe intended to be straight.
- (f) Insecure attachment of branches or spurs.

Rejected pipe shall be plainly marked by the Inspector and immediately removed from the site of the work by the Contractor, without cost to the City.

B. Polyvinyl Chloride Pipe and Fittings:

Polyvinyl chloride (PVC) pipe shall have an integral wall bell and spigot. PVC pipe shall conform to the material and testing requirements of ASTM D 3034-83. Minimum wall thickness shall be SDR 35.

(1) Joints:

Joints for PVC pipe shall be elastomeric gasketed push-on joints conforming to the requirements of ASTM D 3212-81. Lubricant used in making up joints shall be supplied by the pipe manufacturer and the joints shall be coupled in accordance with the manufacturer's requirements.

(2) Pipe Marking:

The following information shall be clearly marked on each length of pipe at intervals of five feet or less:

- (a) Manufacturer's name or trademark and code.
- (b) Nominal pipe size.
- (c) The PVC cell classification (e.g. "12454-B").
- (d) The legend "Type PSM SDR-35 PVC Sewer Pipe".
- (e) The designation "Specification D 3034".

The following information shall be clearly marked on each fitting:

- (a) Manufacturer's name or trademark and code.
- (b) Manufacturer's name or trademark.
- (c) Nominal size.
- (d) The material designation "PVC".
- (e) "PSM"
- (f) The designation "Specification D 3034".

(3) Manufacturer's Certification:

All pipe furnished shall be accompanied by the manufacturer's certificate of test showing conformity with the Specifications. Each certificate shall identify a specific lot number, quantity of pipe, and show actual test results for the lot furnished. These certificates shall be submitted to the Inspector at the time of unloading.

(4) Inspection:

All pipe furnished shall be subject to inspection on arrival at the job site by the Engineer. The purpose of the inspection shall be to cull and reject pipe or fittings that, independent of physical tests specified under the standard specifications designated herein, fail to conform to the requirements of these Specifications.

The Contractor shall notify the Engineer sufficiently in advance so that an Inspector may be on the job during the unloading of materials. A minimum notice of 24 hours is required for such unloading and inspection.

Pipe shall be subject to rejection on account of any of the following:

- (a) Variation in any dimension exceeding the permissible variations given in the material specifications. Pipe in all cases shall be full diameter.
- (b) Fractures or cracks passing through the barrel or socket.
- (c) Chips or fractures on the interior of the pipe exceeding two inches in length, one inch in width, or depth more than 1/4 of the thickness of the wall.
- (d) Blisters that are either broken, exceed three inches in diameter, or project more than 1/8-inch above the surrounding surface of the pipe.
- (e) Variation of more than 1/16-inch per lineal foot in alignment of pipe intended to be straight.

Rejected pipe shall be plainly marked by the Inspector and immediately removed from the site of the work by the Contractor, without cost to the City.

C. Sewer Service Leads, Risers and Fittings:

Allowable pipe materials are; SDR 26 polyvinyl chloride (PVC) plastic conforming to the material and testing requirements of ASTM D 3034; and vitrified clay pipe conforming to the material and testing requirements of ASTM C 700.

Whenever adapters are required to properly connect the pipe with pipe of other material or manufacturer, the nominal I.D. of adapters shall be manufactured for that specific purpose and shall be the same size as the nominal diameter of pipe connected thereto. Adapters shall also be furnished and used as required by the manufacturer. The adaptor at this tapped connection shall be made using either a gasketed sewer saddle, a flexible neoprene rubber boot, or approved equal. Gasketed sewer saddles shall meet the following requirements:

- (a) The castings shall be ductile iron per ASTM 536, Grade 65-45-12, protected with a yellow shopcoat.

(b) The adjustable strap shall be 3.5" wide, stainless steel per ASTM A 240, type 304.

(c) The bolts shall be 0.5" UNC rolled thread, lubricant coated, stainless steel per ASTM A 1943, type 304.

(d) The nuts shall be per ASTM A 194, type 304.

(e) The washers shall be stainless steel per ASTM A 240, type 304 and plastic lubricating washers.

(f) The gaskets shall be SBR per ASTM D 2000 MBA 710, compounded for water and sewer service.

(1) Joints:

Joints for SDR 35 PVC pipe shall be bell and spigot rubber o-ring gasket joints conforming to the requirements of ASTM D-3212. Lubricant supplied by the pipe manufacturer shall be used, and the joints shall be coupled in accordance with the manufacturer's requirements.

Joints for vitrified clay pipe shall be compression type joints conforming to the material and testing requirements of ASTM C 425. Lubricant used in making up joints shall be supplied by the pipe manufacturer and the joints shall be coupled in accordance with the manufacturer's requirements.

Joints for cast iron pipe shall be mechanical compression joints conforming to the material and testing requirements of ASTM C 564.

(2) Pipe Marking:

The following information shall be clearly marked on each length of pipe:

(a) The pipe designation and class (e.g., SDR 35, ASTM D 3034).

(b) The name or trademark of the manufacturer.

(c) Identification of the manufacturing plant.

(d) Testing lot number.

(3) Manufacturer's Certification:

All pipe furnished shall be accompanied by the manufacturer's certificate of test showing conformity with the Specifications. Each certificate shall identify a specific lot number, quantity of pipe, and show actual test results for the lot furnished. These certificates shall be submitted to the Inspector at the time of unloading.

(4) Inspection:

All pipe furnished shall be subject to inspection on arrival at the job site by the Engineer. The purpose of the inspection shall be to cull and reject pipe or fittings that, independent of physical tests specified under the standard specifications designated herein, fail to conform to the requirements of these Specifications.

The Contractor shall notify the Engineer sufficiently in advance so that an Inspector may be on the job during the unloading of materials. A minimum notice of 24 hours is required for such unloading and inspection.

Pipe for sewer service leads and risers shall be subject to rejection on account of any of the following:

- (a) Variation in any dimension exceeding the permissible variations given in the material specifications. Pipe in all cases shall be full diameter.
- (b) Fractures or cracks passing through the barrel or socket.
- (c) Chips or fractures on the interior of the pipe exceeding two inches in length, one inch in width, or depth more than 1/4 of the thickness of the wall.
- (d) Blisters that are either broken, exceed three inches in diameter, or project more than 1/8-inch above the surrounding surface of the pipe.
- (e) Variation of more than 1/16-inch per lineal foot in alignment of pipe intended to be straight.

Rejected pipe shall be plainly marked by the Inspector and immediately removed from the site of the work by the Contractor, without cost to the City.

D. Manholes:

All sanitary sewer manholes shall be constructed of precast reinforced concrete sections. Precast drainage structures shall be designed to accommodate HL-93 Modified Live Load requirements as determined by a Professional Engineer licensed by the State of Michigan, regardless of where they are to be installed. For the purposes of design, a HL-93 Modified Live Load shall consist of 1.2 times the design truck or 1.2 times a single 60 kip load, whichever produces the greater stresses.

Precast reinforced concrete bases, bottom sections, manhole risers, grade adjustment rings, concentric cones, eccentric cones, and flat top slabs shall conform to the requirements of ASTM C 478. Joints on precast manholes used on all sanitary sewers shall meet ASTM C 443, rubber O-ring gasket.

Concrete brick shall conform to the requirements for concrete building brick, ASTM C 55, Grade N-1.

Cast iron frames and covers for manholes shall conform to the requirements for grey iron castings, ASTM A 48, Class No. 30. Specific, approved castings are listed in the Special Provision for "Dr Structure Covers."

Plastic coated manhole steps shall be injection molded of copolymer, polypropylene, encapsulating a 1/2 inch grade 60 steel reinforcing bar. Plastic-coated manhole steps shall meet the performance test described in ASTM C-478, Paragraph II, and shall have an impact resistance of 300 ft.-lbs., with only minor deflection and no cracking or breaking.

The steps shall resist pull out forces of 1500 lbs.

E. Manhole Connections:

Sewer pipe to precast manhole connections shall be through: 1) a flexible neoprene rubber boot which shall be securely clamped into a core-drilled pipe port. Pipe ports shall be core-drilled at the point of manhole manufacture and shall be accurately located within 1/2-inch of proposed sewer centerline; or, 2) a self-adjusting mechanical pipe to manhole seal which provides a resilient, flexible, and infiltration-proof joint; or, 3) a flexible rubber wedge firmly rammed into a rubber gasket which is cast into the manhole as approved in writing by the Engineer.

Neoprene rubber for manhole boots shall meet the requirements of ASTM C 443 and shall have a minimum thickness of 3/8-inch. Pipe clamp bands shall be of corrosion-resistant steel.

c. Construction.

1. Material Handling:

Pipe, fittings and accessories shall be loaded and unloaded by lifting with hoists or skidding so as to avoid shock or damage. Under no circumstances shall such material be dropped. Pipe handled on skidways shall not be skidded or rolled against pipe already on the ground.

In distributing the material at the site of the work, each piece shall be stored off of the ground surface by means of skids or bunks, and stacked neatly. Pipe may be "strung-out" for only the length which, in the opinion of the Engineer, will be installed within 24 hours, if maintained such that the pipe interior will remain free of dirt, mud, and debris.

2. Excavation:

The Contractor shall dig-up and expose all utility crossings prior to laying any sanitary sewer pipe or lead. This will allow the Engineer to adjust the grade of the sanitary sewer or lead, if possible, to avoid the existing utilities. The costs of the dig-ups, and related costs, shall be included in the unit price of the sanitary sewer or lead. The Engineer may require that some dig-ups be performed out-of the staging area where the sewer work is taking place in order to aid in alignment decisions.

Excavation shall include the removal and disposal of all materials of every kind, including rock, boulders, or buried obstructions necessary to be removed in the construction work.

The Contractor shall proceed with caution in the excavation and preparation of the trench so that the exact location of underground structures, both known and unknown, may be determined, and the Contractor shall be held responsible for the repair of such structures when broken or otherwise damaged.

Excavation normally shall be by open cut from the surface, except as otherwise specified, or in special cases where crossing under trees, pavements, or structures. The Contractor may use tunnel methods if permitted in writing by the Engineer, provided his method of backfill is such, in the judgment of the Engineer, as to avoid any present or future injury to the tree, pavement, or structure. All excavation shall be performed in such a manner as to provide adequate room for the construction and installation of the work to the lines, grades and dimensions shown on the Plans.

The trench shall be excavated to a minimum of four inches below the final location of the pipe. This cut shall be filled to the level of the bottom quadrant of the pipe with Coarse Aggregate, 6A as specified herein, shaped and compacted to the pipe barrel.

Bell holes shall be provided in the trench bottom at each joint to permit the joints to be made properly.

Whenever, in the opinion of the Engineer, it is necessary to explore and excavate to determine the location of existing underground structures, the Contractor shall make explorations and excavations for such purposes. These excavations will not be paid for separately, but shall be included in the cost of the item of work being performed. Any backfilling that may be required to be performed as a result of an exploratory excavation that is not part of the backfill associated with the work being undertaken, shall be included in the item of work being performed, with the exception of final trench restoration, which shall be paid for separately using appropriate items of work contained within the contract documents.

All excavated material approved by the Engineer as backfill material and imported backfill material shall be piled in a manner that will not endanger the work and that will avoid obstructing sidewalks and driveways or clear vision areas along roadways, driveways, or parking areas. All excavated material which is unsuitable for backfill shall be immediately removed from the site by the Contractor. Hydrants under pressure, manholes of any kind, valve boxes, curb stop boxes, fire and police call boxes, and other utility controls shall be left unobstructed and accessible until the work is completed. Gutters shall be kept clear, or other satisfactory provisions made, for proper drainage. Natural and man-made water courses shall not be obstructed. Disposal of excavated material, if required, shall be the Contractor's responsibility.

Hand methods for excavation shall be employed in locations shown on the Plans. In other locations the Contractor may use trench-digging machinery or employ hand methods.

3. Pipe Undercut:

In locations where in the opinion of the Engineer, the soil at the bottom of the trench is unstable, the Contractor shall excavate below the trench bottom to such depth as directed by the Engineer and refill with compacted Aggregate, 6A (limestone), or compacted Granular Material, Class II, as directed by the Engineer, to the level of the bottom quadrant of the pipe. If refill with compacted Aggregate, 6A (limestone) is required during sewer construction, it shall be placed for the entire sewer run, from manhole to manhole.

4. Trench Opening:

The width of the trench shall be ample to permit the pipe to be laid and jointed properly, and the backfill to be placed and compacted as specified. Trenches shall be of such extra width, when required, to permit the convenient placing of timber supports, sheeting and bracing, and handling of special fittings. For each size of pipe, the minimum trench width shall provide clearance of four inches on each side of the bell of the pipe or fitting or six inches on each side of the pipe barrel, whichever is greater. The maximum trench width shall be in keeping with good construction practice, such that existing structures are not undermined.

In excavating for pipe lines, the excavation shall at all times be finished to the required grade in advance of the pipe line, but unless otherwise permitted in writing by the Engineer, not more than 50 feet of trench shall be open at one time in advance of the pipe. At no time shall more than 200 feet of trench be opened and incompletely backfilled. At the end of each day, no more than 25 feet of trench may be left open, and access to all drives shall be restored. This opening shall be surrounded by fencing and lighted barricades, or plated. The remainder of the trenching operation shall be available for safe vehicular and pedestrian traffic at all times.

The trench shall be so braced and drained that the workers may work therein safely and efficiently. It is essential that the discharge of the trench dewatering pumps be conducted to natural drainage channels, drains, or storm sewers. If trench water is pumped to natural drainage channels or drains, approved soil erosion and sedimentation controls shall be installed and maintained at the point of discharge. If trench water is pumped into storm sewers, filters shall be provided to prevent the flow of rocks, mud and other debris into the storm sewer line.

The length of street which may be occupied by the construction work at any one time shall be subject to the approval of the Engineer and will be based on the requirements of use of the street by the public.

The Contractor shall fully comply with all laws and regulations governing construction methods and the furnishing and use of all safeguards, safety devices, protective equipment, and pollution controls. Particular care shall be taken to conform to all applicable rules of the Michigan Department of Labor, Construction Safety Standards Commission, "Safety Standards". Part 9 of the above document should be particularly noted.

Where required to support the surfaces of adjacent throughfares, structures, or excavations, or to protect the construction work, adjacent work, or workmen; sheeting, bracing, and shoring shall be provided. The placing of such supports shall not release the Contractor of the responsibility for the sufficiency and integrity of the trench opening. In the removing of sheeting and bracing after the construction has been completed, special care shall be taken to prevent any caving of the sides of the excavation and injury to the completed work or to adjacent property.

Sheeting, bracing, and shoring shall not be left in place after completion of the work except as required by the Engineer. Where the Engineer requires the sheeting, bracing, or shoring to be left in place it shall be cut off below the established surface grade as required by the Engineer.

5. Disposal of Water and Sewage:

The Contractor shall remove by well points, pumping, bailing, or other acceptable method any water which may accumulate or be found in the trenches or other excavations to be made. The Contractor shall take all necessary precautions to keep the trenches and other excavations entirely clear of water and sewage during construction of pipe lines and structures. Newly placed concrete shall be adequately protected from injury resulting from ground water or sewage. No drainage ditches shall be placed within the area to be occupied by any structure except as permitted in writing by the Engineer.

The Contractor shall at all times have upon the work sufficient pumping equipment ready for immediate use to carry out the intent of this section.

Where existing sewers, drains, or ditches are encountered in this work, adequate provisions shall be made for diverting their flow, so that the excavation will be kept dry. Upon completion of the construction work, the existing sewers, drains, or ditches shall be restored as directed by the Engineer.

6. Crossing Existing Structures & Facilities:

During the construction it may be necessary to cross under or over certain sewers, service leads, drains, culverts, water lines, gas lines, electric lines, and other underground structures or facilities, known or unknown. The Contractor shall make every effort to prevent damage to such underground structures and facilities. The Contractor shall not intentionally "dig through" existing facilities with the intention of replacing or repairing them after the proposed work is completed. Wherever such structures or facilities are disturbed or broken, they shall be restored to a condition equal to, or better than, the condition that existed prior the work being performed. All repairs shall be acceptable to the owner and the City and shall be at the Contractor's sole expense. These crossings shall be made with a minimum of twelve inches of vertical clearance between facilities.

7. Laying Pipe:

Each pipe shall be inspected for defects prior to being lowered into the trench. The inside of each pipe and outside of each spigot shall be cleaned of any earth or foreign matter.

Proper implements, tools, and facilities satisfactory to the Engineer shall be provided and used by the Contractor for the safe and convenient prosecution of the work. All pipe and fittings shall be carefully lowered into the trench piece by piece by means of a derrick, ropes, or other suitable tools or equipment as recommended by the manufacturer, in such a manner as to prevent damage to them and their protective coatings and linings. Under no circumstances shall materials be dropped or dumped into the trench.

New sewer construction shall be plugged at the outlet, so as to not be connected into the existing system until it has been tested and accepted. Construction of sewers shall begin at the outlet end and proceed upgrade, unless otherwise directed by the plans or the Engineer. Pipe shall be laid on the prepared subgrade with the bell ends facing the direction of laying, unless otherwise directed by the Engineer.

The Contractor shall take every precaution to prevent foreign material from entering the pipe while it is being placed in the line. During laying operations, no debris, tools, clothing or other materials shall be placed in the pipe. At times when pipe laying is not in progress, the open ends of pipe shall be closed by a watertight plug. This provision shall apply during the break period as well as overnight. If water is in the trench, the seal shall remain in place until the trench is pumped completely dry.

Pipe shall be jointed as specified elsewhere herein. The pipe shall be secured in place with approved backfill material tamped under it except at the bells. Pipe and fittings which do not allow a sufficient and uniform space for joints shall be removed and replaced with pipe and fittings of proper dimensions to insure such uniform space. Precautions shall be taken to prevent dirt from entering the joint space.

All pipe shall be laid at the correct line and grade as indicated by the grade stakes and offset line. The correct line and grade shall be maintained by the use of a laser alignment system. The staking shall be provided by the Engineer. No pipe shall be laid until a cut sheet for that pipe has been approved by the Engineer. Each pipe, as laid, shall be checked by the Contractor to insure that this result is obtained. The grade as shown on the Plans is that of the pipe invert for sewers; the work must conform to this profile. A variation of 1/4 inch from this profile grade will be deemed sufficient reason to cause the work to be rejected and re-laid. Sewer pipe alignment shall be maintained so as to not vary more than one-half inch from the correct line on pipes up to 36 inches in diameter nor more than one inch on pipes 42 inches in diameter and larger. Any pipe found out of line shall be re-laid properly by the Contractor.

Due to conditions in the field, changes to the proposed vertical and horizontal alignment of the proposed sanitary sewer may become necessary. The Contractor shall, where directed by the Engineer, excavate up to 60 feet in advance of the pipe laying operation to expose existing underground facilities thereby enabling the Engineer to make alignment decisions. The Contractor is required to realign (re-lay) the sanitary sewer up to 2 feet vertically and/or horizontally as directed by the Engineer at no extra cost to the project. The excavation in advance of the pipe laying is intended to help eliminate the need for re-laying pipe.

8. Making Joints

A. General:

Mechanical means shall be used for pulling home all rubber-gasket pipe regardless of trench condition where manual means will not result in pushing and holding the pipe home. When a trench box or liner is used, a cable shall be used to pull the joints home and hold them in position.

Where work is performed in wet trenches or trenches with running sand, the Contractor shall provide and use mechanical means for pulling the pipe home in making up the joint and for holding the pipe joints tight until completion of the line. Mechanical means shall consist of a cable placed inside or outside of the pipe with a suitable winch, jack, or come-along for pulling the pipe home and holding the pipe in position.

Where not required by these Specifications, manual means will be acceptable only if the joints can be pushed home and held.

Sewer pipe may not be cut when the cut end will be used in making a pipe joint. Cut ends may only occur in situations such as a manhole or headwall. Cut ends shall be carefully and neatly made with a saw, pipe cutter, or other approved means.

B. Vitrified Clay Pipe:

Compression-type joints shall be made in accordance with manufacturer's standards and ASTM C 425. The jointing surfaces of the pipe shall be wiped clean, and lubricated using lubricants supplied by the pipe manufacturer. The socket and spigot shall be lined up and joined together with a steady, uniformly applied force.

C. Polyvinyl Chloride (PVC) Pipe:

Elastomeric gasket, push-on joints, shall be made in accordance with manufacturer's standards, and ASTM D2321 and D3212. The jointing surfaces of the pipe shall be wiped clean, and lubricated using lubricant supplied by the pipe manufacturer. The spigot end is to be inserted into the bell so that it is in contact with the gasket. The bell is to be braced while the spigot end is pushed in under the gasket, so that previously completed joints will not be altered. The spigot shall be pushed into the bell until the reference mark on the pipe barrel is flush with the end of the bell.

9. Backfilling

A. General:

Backfilling shall not be performed in freezing weather except by written permission of the Engineer, and it shall not be composed of frozen material. No fill shall be placed where the material already in the trench is frozen.

B. Vitrified Clay Pipe:

All pipe shall be bed on a four inch or thicker layer of compacted Granular Material Class II or compacted Aggregate, 6A (limestone) as specified herein.

From the bedding to the pipe centerline backfill shall be carefully placed Granular Material Class II placed in maximum lift thicknesses of six inches, loose measure. Each lift shall be thoroughly compacted by hand tamps, pneumatic "pogo-sticks", or other approved methods, to at least 95% of the material's maximum dry density at optimum moisture content as determined by ASTM D 1557, Method C, or AASHTO T-180. Each lift shall extend the full width of the space between the pipe and trench, and the fill shall be brought up evenly on both sides of the pipe. The backfill under the haunches of the pipe shall be consolidated by the use of a tee-bar.

When the pipe is greater than 48 inch diameter, or when permitted in writing by the Engineer, the Granular Material Class II from the bedding to the centerline may be replaced by Aggregate, 6A (limestone) as specified. A suitable granular filter, designed by the Contractor and approved by the Engineer, shall be provided above the coarse aggregate to prevent intrusion of succeeding backfill materials.

From the pipe centerline to the top of the pipe, backfill shall be Granular Material, Class II placed in maximum lift thicknesses of six inches, loose measure. Each lift shall be thoroughly compacted by hand tamps, pneumatic "pogo-sticks", or other approved methods, to at least 95% of the material's maximum dry density at optimum moisture content as determined by ASTM D 1557 Method C, or AASHTO T-180.

From the top of the pipe to two feet above the top of the pipe backfill shall be Granular Material, Class II uniformly spread and machine tamped. Machine tamping shall include manually operated vibrating plate compactors. The backfill material shall be compacted in lifts of twelve inches, loose measure.

From two feet above the top of the pipe to the grade shown on the Plans and Details, or to the subgrade of roadway materials, or to the subgrade of surface structures, backfill shall be Granular Material, Class II uniformly spread and machine tamped. If machine tamping includes manually operated vibrating plate compactors or self propelled vibrating rollers the backfill material shall be compacted in lifts not exceeding twelve inches, loose measure. If a backhoe mounted compactor is employed, the backfill material shall be compacted in lifts of thirty-six inches, loose measure. Approval to use a particular machine tamping method will be withdrawn by the Engineer if the method causes injury to the pipe or adjacent structures or movement of the pipe. Each lift shall be thoroughly compacted to at least 95% of the material's maximum dry density at optimum moisture content as determined by ASTM D 1557, Method C, or AASHTO T-180. The Engineer may give consideration to giving written permission to increase the thickness of the lifts specified in this paragraph if satisfactory compaction is achieved and no undesirable side effects occur.

C. PVC Pipe:

All pipe shall be bed on a four inch or thicker layer of compacted Coarse Aggregate, 6A (limestone) as specified herein.

From the bedding to the pipe centerline backfill shall be carefully placed Coarse Aggregate, 6A (limestone), placed in maximum lift thicknesses of six inches, loose measure. Each lift shall be thoroughly compacted by hand tamps, pneumatic "pogo-sticks", or other approved methods. Each lift shall extend the full width of the space between the pipe and trench, and the fill shall be brought up evenly on both sides of the pipe. The backfill under the haunches of the pipe shall be consolidated by the use of a tee-bar.

From the pipe centerline to the top of the pipe, backfill shall be Aggregate, 6A (limestone) placed in maximum lift thicknesses of six inches, loose measure. Each lift shall be thoroughly compacted by hand tamps, pneumatic "pogo-sticks", or other approved methods. A layer of geotextile separator, meeting the requirements of Section 910, extending the full width of the trench, shall be provided above the coarse aggregate to prevent intrusion of succeeding backfill materials.

From the top of the pipe to two feet above the top of the pipe, unless otherwise specified, backfill shall be Granular Material Class II placed in a maximum lift thickness of twelve inches, loose measure. These lifts shall be thoroughly compacted by manually operated vibrating plate compactors, to at least 95% of the material's maximum dry density at optimum moisture content, as determined by ASTM D 1557, Method C, or AASHTO T-180.

From two feet above the top of PVC pipe to the grade shown on the Plans and Details, or to the subgrade of roadway materials, or to the subgrade of surface structures, backfill shall be Class II granular material uniformly spread and machine tamped. If machine tamping includes manually operated vibrating plate compactors or self propelled vibrating rollers the backfill material shall be compacted in lifts not exceeding twelve inches, loose measure. If a backhoe mounted compactor is employed, the backfill material shall be compacted in lifts of thirty-six inches, loose measure. Approval to use a particular machine tamping method will be withdrawn by the Engineer if the method causes injury to the pipe or adjacent structures or movement of the pipe. Each lift shall be thoroughly compacted to at least 95% of the material's maximum dry density at optimum moisture content as determined by ASTM D 1557, Method C, or AASHTO T-180. The Engineer may give consideration to giving written permission to increase the thickness of the lifts specified in this paragraph if satisfactory compaction is achieved and no undesirable side effects occur.

11. Concrete Cradle and Encasement for Sewers:

Where shown on the Plans, pipe shall be installed with a concrete cradle or encasement of Concrete, Grade X as shown on the Standard Details or plan sheets. Cradle or encasement shall be for the full run of the sewer, from manhole to manhole. Each pipe shall rest on a bed of Concrete, Grade X, shaped to fit the bottom of the pipe. After setting the pipe, the space between the outside of the pipe and the undisturbed trench bank shall be completely filled with Concrete, Grade X. Concrete, Grade X used for this purpose shall have a slump not exceeding two inches.

12. Riser Pipe for Service Leads:

Where shown on the Plans or directed by the Engineer, the Contractor shall furnish and place risers extending from the branch opening of the sewer up to within eight to ten feet of the proposed finished grade. These pipes shall be laid with joints as specified above. These risers shall be laid up and held in place as required by the Standard Details. The connection fitting when a riser is to be used shall be a tee fitting. Openings in the top of the riser pipe shall be closed, marked, and staked as specified above.

13. Service Lead Connections and Fittings:

Service lead connections shall be provided at such points as shown on the Plans or as directed by the Engineer. These shall be of the size and character indicated on the Plans. House service leads shall be a minimum of four inches in diameter. Service lead connections shall be formed by the use of standard wye or tee fittings of the same material called for use on the main sewer being constructed. Wye fittings are not to be used for connections with riser pipes. All wye and tee fittings shall be encased in Concrete, Grade X. All leads which will not have pipe connected to them immediately shall be closed by the use of a watertight plug manufactured specifically for that purpose and approved by the Engineer.

Branch connections to existing sewers shall be made by the City of Ann Arbor – Field Operations Personnel. Scheduling of these taps shall be made with Field Operations by the Contractor. All applicable tap fees must be paid in full prior to this scheduling.

Connections for sewer service leads connecting to existing sewer mains or sewer mains of a different pipe material shall be at a core-drilled tap into the sewer pipe. The joint at this tapped connection shall be made using either a gasketed sewer saddle, a flexible neoprene rubber boot securely clamped into the core-drilled tap, or approved equal. The end of the sewer service lead pipe shall be flush with the inside wall of the sewer main. Gasketed sewer saddles shall meet the following requirements:

- (a) The castings shall be ductile iron per ASTM 536, Grade 65-45-12, protected with a yellow shopcoat.
- (b) The adjustable strap shall be 3.5" wide, stainless steel per ASTM A 240, type 304.
- (c) The bolts shall be 0.5" UNC rolled thread, lubricant coated, stainless steel per ASTM A 1943, type 304.
- (d) The nuts shall be per ASTM A 194, type 304.
- (e) The washers shall be stainless steel per ASTM A 240, type 304 and plastic lubricating washers.
- (f) The gaskets shall be SBR per ASTM D 2000 MBA 710, compounded for water and sewer service.

In order to properly mark the location of every branch connection, the Contractor shall take accurate measurement of all branches before the sewer trench is backfilled. The measurements shall indicate the distance from each branch to the center of the nearest downstream and upstream manhole. When leads are run to the property line, they shall be perpendicular to the main sewer. The Contractor shall also report the location of the point where the lead ends, relative to the nearest property corners. The Contractor shall furnish the Engineer with a copy of these measurements immediately upon the completion of each section of sewer.

In addition to measurements, the Contractor shall furnish and place a minimum two inch by two inch cedar or treated lumber marking stick at the end of each lateral extension or service lead connection of such length that it will reach from the end of the pipe vertically up to a minimum of two inches above the proposed finished grade. Each marker shall be set in a vertical position. Markers will not be required on the main run of sewer at fittings. The visible end of each marker stake must be plainly painted red if sanitary or white if storm.

The service lead pipes shall also be marked for identification in order to prevent cross connection of the leads: sanitary leads - red, storm leads - white. The last two lengths of pipe shall be marked by wrapping the appropriate colored tape twice around the barrel. This wrapping shall take place at any point in the lead whenever the lead is terminated. This taping (wrapping) must be performed under the inspection of the Inspector.

14. Manholes:

Excavation shall be carried to the depth and width required to permit the construction of the required base. The excavation width shall be greater than the base. The bottom of the excavation shall be trimmed to a uniform horizontal bed and be completely dewatered before any concrete is placed therein. Concrete shall be Grade S2. Precast manhole bases and precast bottom sections are allowed.

Precast concrete manholes shall be constructed of Concrete, Grade S2.

Circular precast manhole sections shall be constructed in accordance with the Standard Detail Drawings. Manhole stack units shall be constructed on level poured-in-place bases, precast concrete bases, or precast concrete bottom sections.

Precast cone sections shall be constructed in accordance with the Standard Details. These units shall be eccentric for all manholes. All structures shall be topped with a minimum of one and a maximum of three brick or precast adjustment ring courses.

Manholes shall be constructed within 2-1/2 inches of plumb.

Frames and cover castings shall be set in full mortar beds and pointed on the structure interior to a smooth, brushed finish. The covers shall be set flush with sidewalk, roadway pavement, or ground surfaces. City of Ann Arbor Project Management Personnel shall be notified prior to the final paving of all private roads and parking lots so as to allow inspection of the final casting adjustments for all City utility structures. In gravel streets, covers shall be set six to eight inches below finished gravel surface.

Sewer pipes shall extend into structures a minimum of 1/2 inch and a maximum of 3 inches.

Flow channels for sewer structures shall be finished in accordance with the Standard Details. All flow channels shall be screeded and floated to a smooth, uniform surface and troweled to a hard surface finish. In vitrified clay sewers, the manhole may be constructed around the pipe, then the top half of the pipe broken out with concrete fillets provided to fill in between the pipe and manhole.

Stubs for future sewer connections shall be furnished and placed by the Contractor as shown on the Plans and as directed by the Engineer. Connections shall be properly supported and braced when not resting on original ground so that any settlement will not disturb the connection. Stubs shall consist of one length of sewer pipe, of the size indicated on the Plans, with a watertight plug.

See Sewer Testing section for the requirement of the installation of a pipe nipple through the sewer manhole wall.

15. Drop Connections:

Where shown on the Plans or directed by the Engineer where a branch sanitary sewer is brought into a manhole more than 24 inches above the invert elevation in the manhole, a drop connection shall be provided in accordance with the Standard Detail Drawings.

16. Backfilling Around Manholes:

As soon as practicable after a precast structure has been set, forms and debris have been removed from the structure, and the structure has been inspected and approved, the excavated area around the structure shall be backfilled up to the specified grade with Granular Material, Class II. No boulders, rocks, stones, masonry, lumber, or debris shall be allowed within the backfill.

17. Sewer Testing:

All sanitary sewers, including leads, 36 inches and smaller shall be air tested by the Contractor. All sanitary sewers greater than 36 inches shall be infiltration or exfiltration tested by the Contractor. The Engineer will decide whether infiltration or exfiltration testing is performed based upon ground water conditions. All sewers, except 4-inch and 6-inch leads, shall be television inspected by the Contractor. All PVC sanitary sewer mains shall be mandrel tested. All sewer must meet each test, in order (mandrel testing, air or infiltration/exfiltration, television inspection), before the next test is performed. The Contractor shall furnish all labor, equipment and materials necessary for testing. Only after all tests have been successfully completed, and acknowledged by the Engineer in writing, may the sewer be placed in service.

A. Mandrel Testing:

All PVC sanitary sewer mains shall be mandrel tested for deflection by the Contractor. The mandrel shall be a commercially produced, nine-fin mandrel, with the pipe diameter, percent deflection and applicable ASTM or AASHTO standard stamped on the fins. The testing is to take place after the sewers have been in place for a minimum of 30 days. The mandrel shall be pulled from structure to structure. Any portion of the pipe through which the mandrel passes freely shall be deemed to have passed the mandrel test. Sections of pipe through which the mandrel does not pass freely shall be exposed and examined. Based on this examination the pipe zone bedding and backfill shall be improved, or the pipe replaced. The pipe shall then be re-tested before approval is granted.

The Contractor shall not be granted an extension of contract time for the period in which a portion(s) of PVC sanitary sewer is awaiting mandrel and other acceptance tests. This waiting period is understood to be an integral element of the construction of the utility and cannot be eliminated. Further, if a sewer is installed and requires remedial action in order to comply with the requirements of the project specifications, the waiting period associated with the remedial repairs shall also not be considered as a basis for an extension of contract time. The Contractor shall take these requirements into account when preparing their Critical Path Schedule, and any required updates, and shall account for them during the performance of the project.

The mandrel is to be constructed in accordance with the following table:

SDR 26 PVC, Pipe I.D.	Mandrel O.D.
8"	7.28"
10"	9.08"
12"	10.79"
15"	13.20"
18"	N/A
24"	N/A

B. Air Test:

The air test can be dangerous. Lack of understanding, carelessness, or an improperly prepared line must be avoided. It is extremely important that the plugs be installed in such a way as to prevent blowouts. Sudden expulsion of a poorly installed or partially deflated plug can cause serious injury or damage. As a safety precaution, pressurizing equipment must include a relief valve set at not more than 10 psig. No one will be allowed in the manholes during testing.

In areas where ground water is known to exist and the sewer is to be air tested, the Contractor shall install a 1/2-inch diameter by approximately 10 inch long pipe nipple, through the manhole wall above one of the sewer lines entering the manhole. The pipe nipple shall be capped on the inside of the manhole at the time the sewer line is installed. Immediately prior to the performance of the air test, the ground water level shall be determined by removing the pipe cap, blowing air through the pipe nipple into the ground so as to clear it, and then connecting a clear plastic tube to the pipe nipple. The tube shall be held vertically and a measurement of the height in feet of water above pipe centerline shall be taken after the water stops rising in this plastic tube. The height in feet shall be divided by 2.31 to establish the pressure (in psig) that will be considered to be the average ground water back pressure.

The normal sequence and time requirements for air testing are:

(1) After a manhole-to-manhole section of line has been backfilled and cleaned, it shall be plugged at each manhole with pneumatic plugs. The design of the pneumatic plugs shall be such that they will hold against the line test pressure without requiring external blocking or bracing. There shall be three hose connections to the pneumatic plug. One hose shall be used only for inflation of the pneumatic plug. The second hose shall be used for continuously reading the air pressure rise in the sealed line. The third hose shall be used only for introducing low pressure air into the sealed line.

(2) Low pressure air shall be introduced into the sealed line until the internal air pressure reaches 4.0 psig greater than the average back pressure of any ground water pressure that may be over the pipe. At least two minutes shall be allowed for the air pressure to stabilize. After the stabilization period, the pressurization hose shall be disconnected to prevent air from entering or escaping from the line.

There shall be a pressure gauge for reading the internal pressure of the line being tested. The gauge shall be capable of showing pressure as low as 0 psig up to no greater than 20 psig. In the 0-10 psig range the gauge shall be both calibrated and accurate to one-tenth of one pound and the gauge dial shall cover at least one-half of the complete dial range. This gauge shall have a tee fitting to allow simultaneous pressure reading by a City gauge.

(3) The time requirement for the pressure to decrease from 3.5 to 2.5 psig (greater than the average back pressure of any ground water that may be over the pipe) shall not be less than the time given in the following table:

<u>Pipe Size</u>	VCP SEWERS	PVC SEWERS	
	<u>Minimum Holding Time Seconds/100 ft. Pipe</u>	<u>Holding Time (Seconds)</u>	<u>Minimum Holding Time (Min:Sec)</u>
4-inch	18	0.380 x Length	3:46
6-inch	42	0.854 x L	5:40
8-inch	72	1.520 x L	7:34
10-inch	90	2.374 x L	9:26
12-inch	108	3.418 x L	11:20
15-inch	126	5.342 x L	14:10
18-inch	144	7.692 x L	17:00
21-inch	180	10.470 x L	19:50
24-inch	216	13.674 x L	22:40
30-inch	288	21.366 x L	28:20
36-inch	360	30.768 x L	34:00

C. Infiltration Test:

The Contractor shall place temporary weirs for testing purposes in such manholes as necessary to measure the amount of infiltration. Test sections shall be no longer than 1,200 feet.

The allowable amount of infiltration shall not be more than 200 gallons per inch of pipe diameter per mile of sewer per 24 hours, including manholes. The Contractor shall repair all visible leaks regardless of the results of the infiltration test.

If the allowable limit of infiltration is exceeded on any test section, the Contractor shall reconstruct or repair the defective portion of the sewer, and re-test.

D. Exfiltration Test:

The standpipe method will be used from manhole to manhole for the length of pipe to be tested. A hydrostatic head of 10 ft. to the sewer's average centerline elevation will be required, with adjustments for external submergence due to water in the trench. The Engineer will establish time durations and procedures for each test. The maximum allowable exfiltration rate will be 200 gallons per inch of pipe diameter per mile of sewer per 24 hours including manholes. Upon completion of this test on a sanitary sewer, the Contractor shall pump all water out of the downstream manhole to a storm sewer.

18. Television Inspection:

A video inspection must be approved prior to the acceptance of the sewers, and prior to any building connections being made. The Engineer shall be given 24 hours notice so that an Inspector may witness the video inspection. All sewer lines are to be thoroughly cleaned prior to video inspection, by jetting of the lines or other approved methods. Video inspection shall consist of wetting the invert of the section by pouring clean water in the upstream manhole until it appears in the downstream manhole, and then, after the water has stopped flowing, passing a video camera through the section. The camera shall be connected to a monitor and the results recorded in DVD format. The inspection record (DVD) shall indicate the date, the section tested, and the actual distance from the beginning manhole to each tee or wye, and each visible defect. The DVD shall be furnished to the Engineer for further review and final approval.

The video inspection will be deemed satisfactory if there are no visible defects, including, but not limited to: dips or low spots, high spots, deviations in horizontal or vertical alignment, joint offsets, leaks or cracks and there is no debris or other foreign material in the sewer system.

19. Sewer Repairs:

If a sewer repair is required as a result of damage during construction operations, air test failure, or video inspection failure, the Contractor shall expose the sewer pipe and perform the required correction(s), as specified herein and as directed by the Engineer. The Contractor shall be fully responsible to provide a written plan of all proposed activities associated with any repair(s) for the review and approval of the Engineer. All repairs proposed shall be effective. The Engineer's acceptance of a proposed repair plan shall not be construed as acceptance of any associated result. The Contractor is, and shall remain responsible, for all work until such time as it is formally accepted in writing by the Engineer.

If the repair is required due to the pipe being out of alignment or off grade, the pipe shall be adjusted so as to be placed in proper alignment and grade. Aggregate, 6A (limestone) shall be carefully placed under the haunches of the realigned pipe and compacted by the use of a tee-bar. From the haunches of the pipe, backfilling shall be performed as specified elsewhere herein.

If the pipe cannot be satisfactorily realigned or an open joint reset; or if the pipe is cracked, broken, or permanently deflected, the affected pipe shall be removed and replaced with the same pipe material. The pipe to be removed is to be sawed on each side of the damaged section in a neat and workmanlike manner without damage to the adjacent pipe. The replacement pipe section shall fit flush to the remaining pipe at each end. These sawed joints shall be coupled using a flexible pipe coupling and stainless steel shear ring. These joints shall be encased to the pipe centerline with Concrete, Grade X one foot on either side of the flexible coupling. The remaining pipe backfill shall be performed as specified elsewhere herein.

d. Measurement and Payment. The completed work, as described, will be paid for at the contract unit prices respectively for the following pay items:

<u>Pay Item</u>	<u>Pay Unit</u>
Sewer, C-700 ES VCP, ___ inch, Tr Det ___	Foot
Sewer, C-700 ES VCP, ___ inch, Tr Det ___ Modified.....	Foot
Sewer, C-700 ES VCP, Tee or Wye, ___ inch by ___ inch	Each
Sewer, SDR 26 PVC, ___ inch, Tr Det ___	Foot
Sewer, SDR 26 PVC, ___ inch, Tr Det ___ Modified	Foot
Sewer, SDR 26 PVC, Service Lead, ___ inch, Tr Det ___	Foot
Sewer, SDR 26 PVC, Service Lead, ___ inch, Tr Det ___ Modified.....	Foot
Sewer, SDR 26 PVC, ___ deg Bend, ___ inch,	Foot
Sewer, SDR 26 PVC, Riser, ___ inch,.....	Foot
Sewer, SDR 26 PVC, Tee or Wye, ___ inch by ___ inch	Each
Sewer Manhole, Type I, ___ inch dia.....	Each
Sewer Manhole, Type I, ___ inch dia, Add Depth	Foot
Sewer Manhole, Type II, ___ inch dia.....	Each
Sewer Manhole, Type II, ___ inch dia, Add Depth	Foot
Sewer Manhole, Type III, ___ inch dia.....	Each
Sewer Manhole, Type III, ___ inch dia, Add Depth	Foot
Sewer Manhole, Type IV (Sampling), ___ inch dia	Each
Drop Connection, ___ inch	Foot

Sewer pipe as specified shall be measured in place by length in feet from center of manhole to center of manhole.

Payment will include, but not be limited to; excavation; removal and proper disposal off-site of all excess or unsuitable excavated material; any needed sheeting, shoring and bracing; the installation of water-tight plugs; protection of all existing utilities and service connections; connections into existing structures; bulkheading existing connections that are no longer needed in existing manholes; pipe bedding; by-pass pumping; furnishing an approved geotextile separator; backfilling per the trench details and the requirements specified herein; cleaning; video inspection; and testing.

Service tees or wyes shall be paid for based on each tee installed. The payment for the service tee will include the material, equipment and labor costs for the connection of the riser or lead to the tee. Also, the payment for the service tee will include the material, equipment and labor costs for the excavation; removal and proper disposal off-site of all excess or unsuitable excavated material; any needed sheeting, shoring and bracing; the installation of water-tight plugs; protection of all existing utilities and service connections; pipe bedding; by-pass pumping; furnishing an approved geotextile separator; backfilling per the trench details and the requirements specified herein; cleaning; testing; placing the plug or cap placed on the tee, riser or lead; and, the required wooden stake to locate the riser or lead in the future.

Service risers shall be paid for based on the installed height measured in feet from invert of the sewer main to invert of the bend at the top of the riser.

Service leads shall be paid for based on installed length measured feet from the center of the main to the capped end of the lead. If a service riser is installed, this measurement shall be from the center of the bend at the top of the riser to the capped end of the lead. The payment for service leads will include, but not be limited to; excavation; removal and proper disposal off-site of all excess or unsuitable excavated material; any needed sheeting, shoring and bracing; the installation of water-tight plugs; protection of all existing utilities and service connections; connections into existing structures; pipe bedding; by-pass pumping; furnishing an approved geotextile separator; backfilling and compacting per the trench details and the requirements specified herein; cleaning; video inspection; testing; and, the necessary fittings, labor and equipment to connect the lead to a riser.

Manholes of the detail and depth specified will be paid for at the Contract unit price for each unit installed. Payment includes, but shall not be limited to; furnishing the labor, equipment and materials for all necessary excavation; any needed sheeting, shoring and bracing; properly disposing of surplus or unsuitable excavated material; backfilling and compaction; and, constructing the structure complete, including pipe connections and structure cleaning, up to 10 feet of drainage structure depth.

Payment for additional depth for drainage structures includes, but shall not be limited to; furnishing the labor, equipment, and materials for all necessary excavation; any needed sheeting, shoring and bracing; disposing of surplus excavated material; backfilling and compaction; and constructing the structure complete, including pipe connections and structure cleaning, for the portion of the structure which is deeper than 10 feet.

Payment for adjusting of manhole frames and covers shall be included in payment for the manhole. The manhole frames and covers will be paid for separately.

Payment for drop connections shall be based on the installed vertical height measured in feet from the bottom invert of the drop connection to the top invert of the drop connection. Payment includes, but shall not be limited to; furnishing all labor, equipment and materials for all necessary excavation; any needed sheeting, shoring and bracing; proper removal and disposal off-site of surplus and unsuitable excavated material; pipe, fittings, and concrete; backfilling and compaction; and, connections to complete this item of work.

APPENDICES

Soil Boring Logs

Special Details

MDOT Special Provisions

MDOT Supplemental Specifications

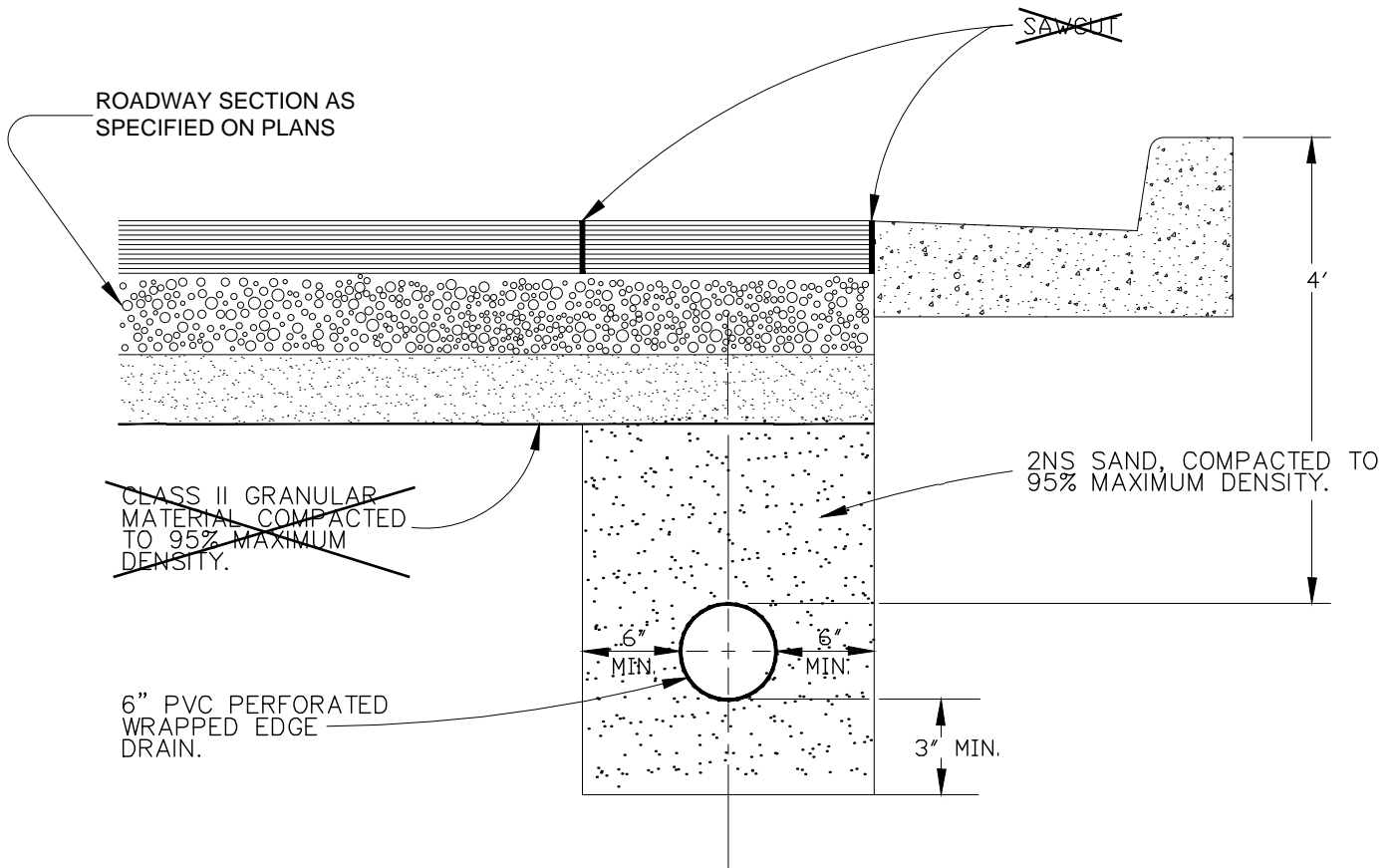

RETITLED	1	NCF	CSS	1-31-94
REVISIONS	REV. NO.	DR. BY	CH. BY	DATE
PUBLIC SERVICES DEPARTMENT CITY OF ANN ARBOR				
EDGE DRAIN TRENCH IN RESURFACED STREET				
DR. BY	DF	CH. BY	CSS	DRAWING NO.
SCALE	NONE	DATE	11-6-92	STD-TD-11 (MODIFIED)
INCH	0  1			SHEET NO. _____ OF _____

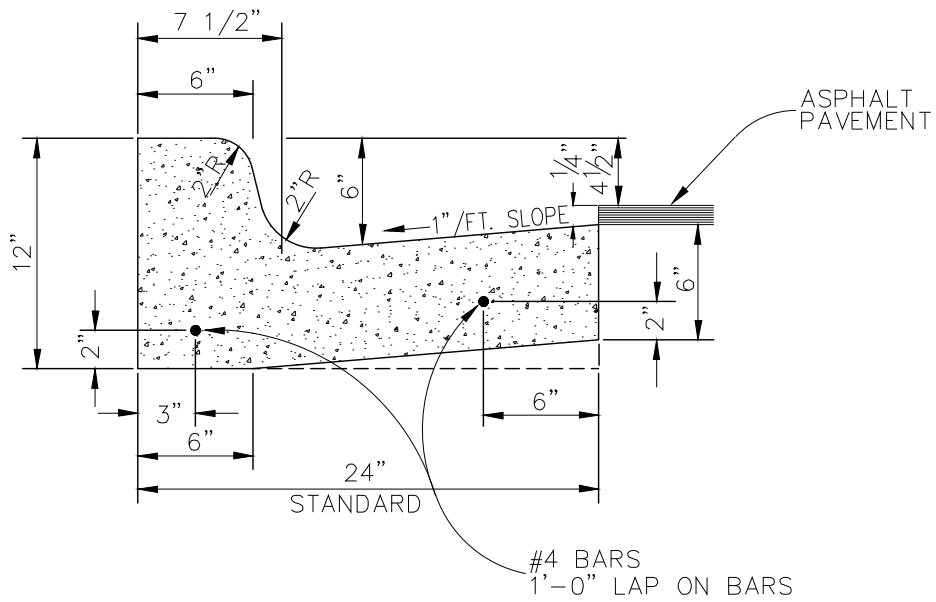

REVISIONS					REV. NO.	DR. BY	CH. BY	DATE
PUBLIC SERVICES DEPARTMENT CITY OF ANN ARBOR								
BARRIER CURB AND GUTTER								
DR. BY	DF	CH. BY	CSS	DRAWING NO.				
SCALE	NONE	DATE	11-6-92	SD-R-1				
INCH	0  1			SHEET NO. ____ OF ____				

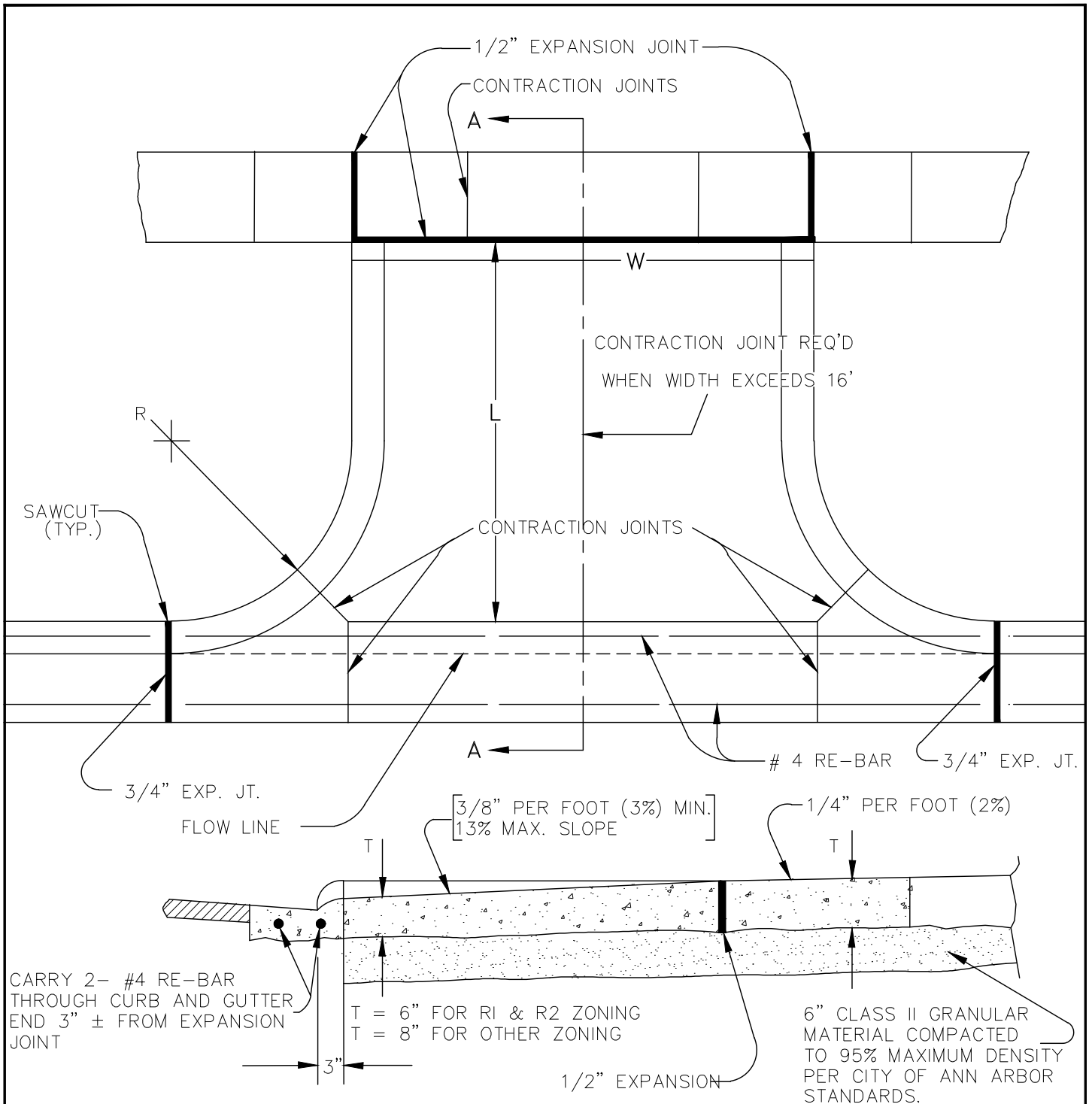

MEASUREMENT OF AREA

SEC. A - A

$W \times L = \text{AREA}$

NOTE: DRIVE APPROACH TO BE CLASS 'A' CONCRETE

NOTE: R(RADIUS) AND W(DRIVE WIDTH) AS REQUIRED FOR ZONING BY CITY CODE

NOTE: IF GUTTER IS OVERLAYED, GUTTER OF THE APPROACH SHALL BE AT SAME ELEVATION AS EXISTING GUTTER AND ASPHALT WEDGE SHALL BE PLACED IN THE APPROACH.

S/W GRADE REVISED		1	NCF	CSS	1-31-94
REVISIONS		REV. NO.	DR. BY	CH. BY	DATE
PUBLIC SERVICES DEPARTMENT CITY OF ANN ARBOR					
TYPE 'M' DRIVE APPROACH (FOR USE ON ASPHALT STREETS WITH BARRIER CURB)					
DR. BY	DF	CH. BY	CSS	DRAWING NO.	
SCALE	NONE	DATE	11-6-92	SD-R-6	
INCH	0 1			SHEET NO. ____ OF ____	

- * MAXIMUM TURNING SPACE SLOPE IS 2.0% IN EACH DIRECTION OF TRAVEL. MINIMUM DIMENSIONS 5' x 5'. SEE NOTES.
- ** MAXIMUM RAMP CROSS SLOPE IS 2.0%, RUNNING SLOPE 5% - 7% (8.3% MAXIMUM). SEE NOTES.

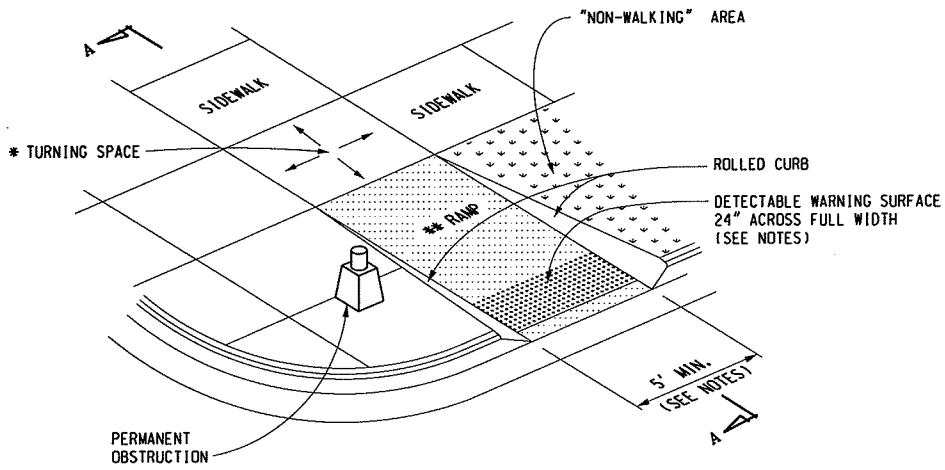

SIDEWALK RAMP TYPE R
(ROLLED SIDES)

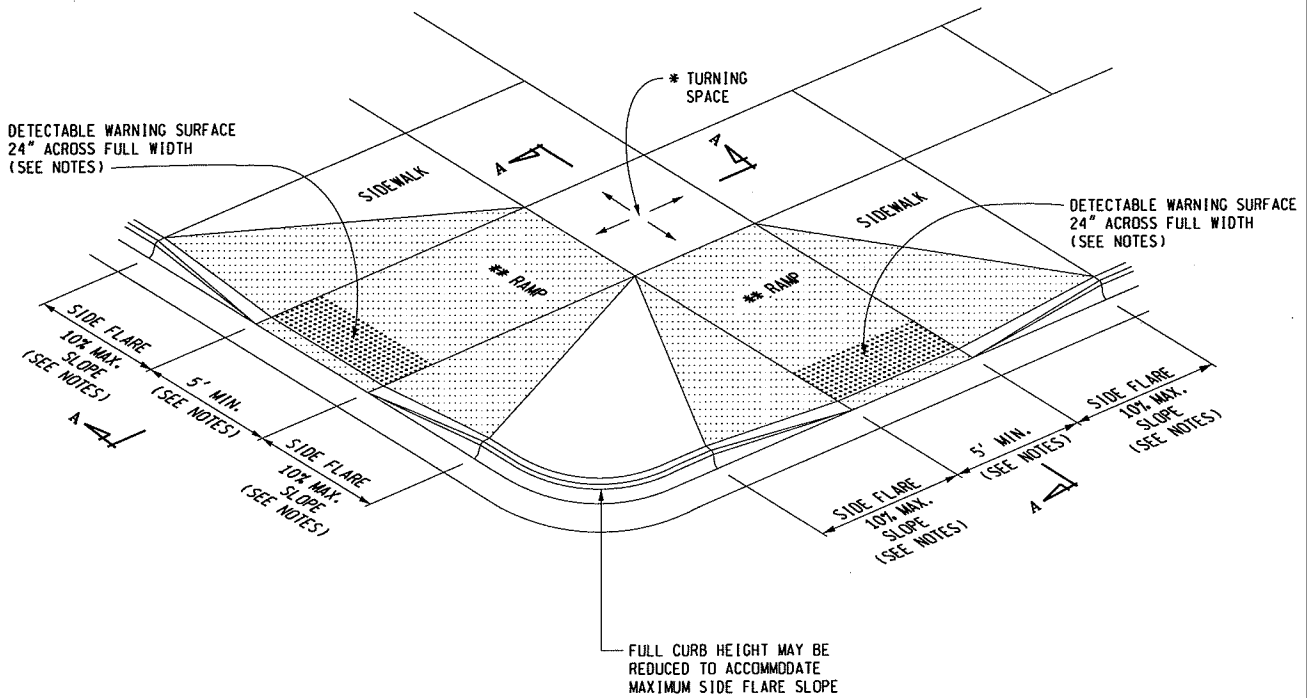

SIDEWALK RAMP TYPE F
(FLARED SIDES, TWO RAMPS SHOWN)

<p>PREPARED BY DESIGN DIVISION</p> <p>DRAWN BY: <u>B.L.T.</u></p> <p>CHECKED BY: <u>W.K.P.</u></p>	<p>DEPARTMENT DIRECTOR Kirk T. Stuedle</p> <p>APPROVED BY: <u>Randy Van Bortel</u> DIRECTOR, BUREAU OF FIELD SERVICES</p>	<p>MICHIGAN DEPARTMENT OF TRANSPORTATION BUREAU OF HIGHWAY DEVELOPMENT STANDARD PLAN FOR</p>	
	<p>APPROVED BY: <u>Mark A. Van Paul</u> DIRECTOR, BUREAU OF HIGHWAY DEVELOPMENT</p>	<p>9-30-2014 F.H.W.A. APPROVAL</p>	<p>7-1-2014 PLAN DATE</p>

**SIDEWALK RAMP AND
DETECTABLE WARNING DETAILS**

* MAXIMUM TURNING SPACE SLOPE IS 2.0% IN EACH DIRECTION OF TRAVEL. MINIMUM DIMENSIONS 5' x 5'. SEE NOTES.

** MAXIMUM RAMP CROSS SLOPE IS 2.0%. RUNNING SLOPE 5% - 7% (8.3% MAXIMUM). SEE NOTES.

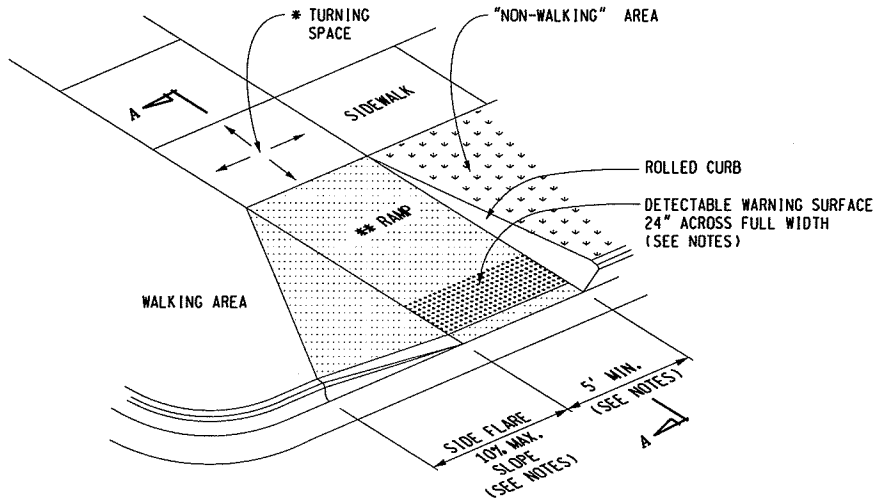

SIDEWALK RAMP TYPE RF
(ROLLED / FLARED SIDES)

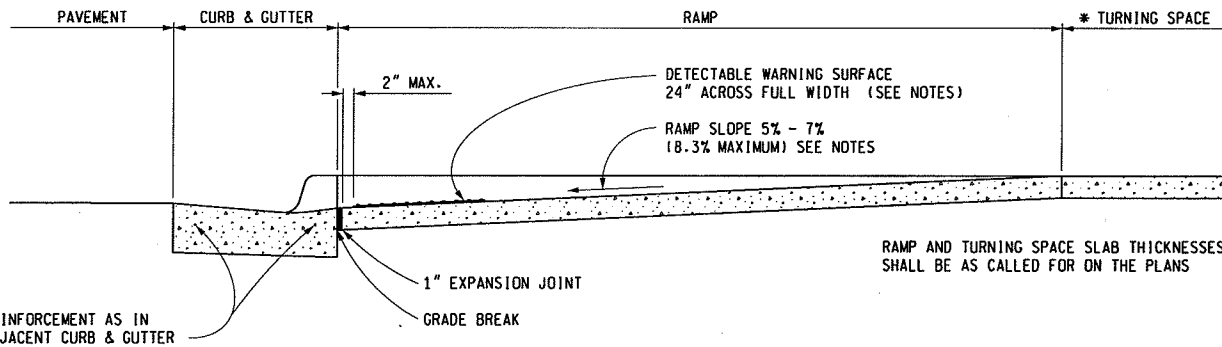

SECTION A-A

*** TRANSITION ADJACENT GUTTER PAN CROSS SECTION TO PROVIDE 5.0% MAXIMUM COUNTER SLOPE ACROSS THE RAMP OPENING.

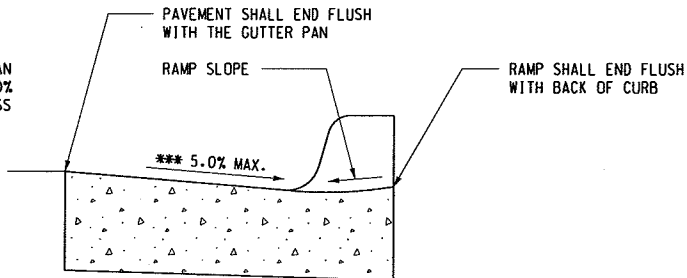

SECTION THROUGH CURB CUT
(TYPICAL ALL RAMP TYPES)

MICHIGAN DEPARTMENT OF TRANSPORTATION
BUREAU OF HIGHWAY DEVELOPMENT STANDARD PLAN FOR

**SIDEWALK RAMP AND
DETECTABLE WARNING DETAILS**

9-30-2014 F.H.W.A. APPROVAL	7-1-2014 PLAN DATE	R-28-I	SHEET 2 OF 7
--------------------------------	-----------------------	--------	-----------------

* MAXIMUM TURNING SPACE SLOPE IS 2.0% IN EACH DIRECTION OF TRAVEL. MINIMUM DIMENSIONS 5' x 5'. SEE NOTES.

** MAXIMUM RAMP CROSS SLOPE IS 2.0%, RUNNING SLOPE 5% - 7% (8.3% MAXIMUM). SEE NOTES.

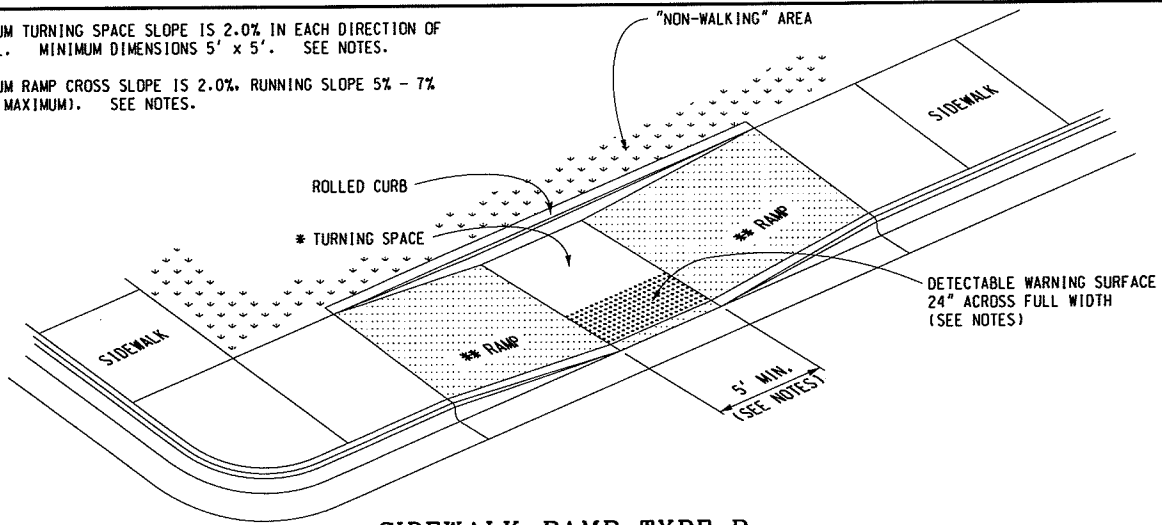

SIDEWALK RAMP TYPE P

(PARALLEL RAMP)

DO NOT USE IN AREAS WHERE PONDING MAY OCCUR

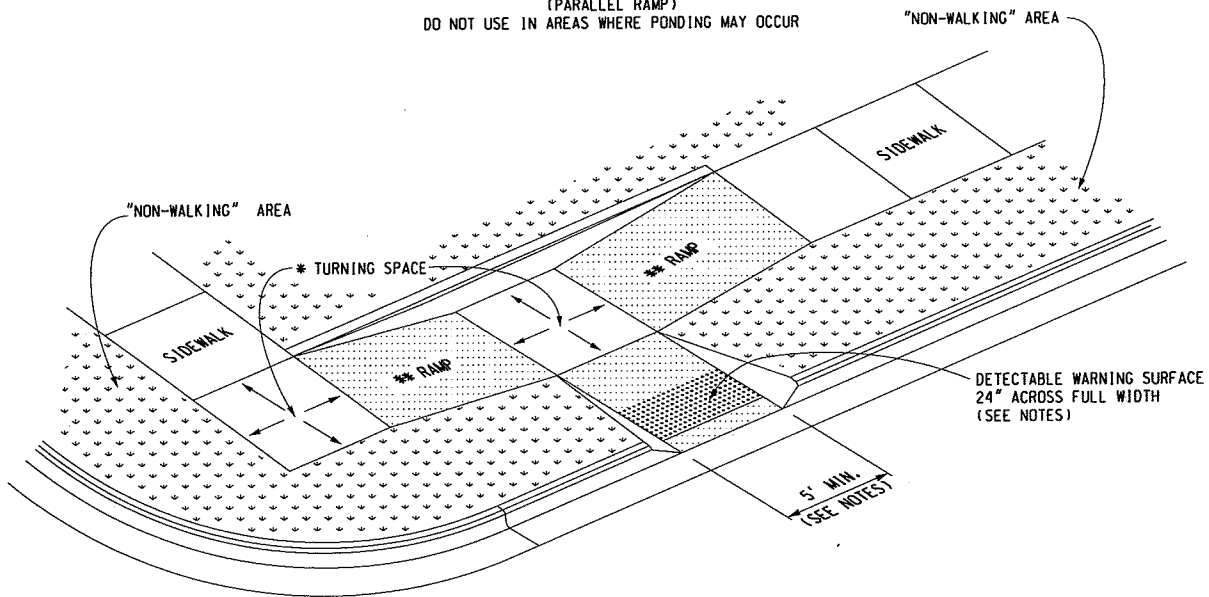

SIDEWALK RAMP TYPE C

(COMBINATION RAMP)

USE 24" DEEP DETECTABLE WARNINGS IF MEDIAN WIDTH IS AT LEAST 6'-0". OTHERWISE NO DETECTABLE WARNING IS REQUIRED.

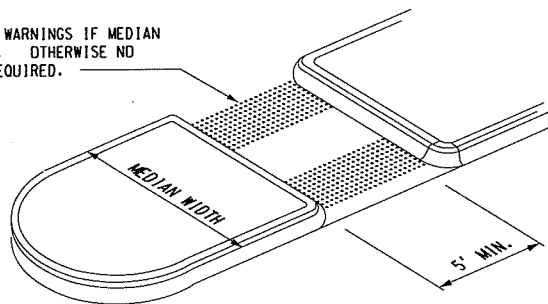

SIDEWALK RAMP TYPE M

(MEDIAN ISLAND)

MICHIGAN DEPARTMENT OF TRANSPORTATION
BUREAU OF HIGHWAY DEVELOPMENT STANDARD PLAN FOR

**SIDEWALK RAMP AND
DETECTABLE WARNING DETAILS**

9-30-2014
F.H.W.A. APPROVAL

7-1-2014
PLAN DATE

R-28-I

SHEET
3 OF 7

* MAXIMUM TURNING SPACE SLOPE IS 2.0% IN EACH DIRECTION OF TRAVEL. MINIMUM DIMENSIONS 5' x 5'. SEE NOTES.

** MAXIMUM RAMP CROSS SLOPE IS 2.0%. RUNNING SLOPE 5% - 7% (8.3% MAXIMUM). SEE NOTES.

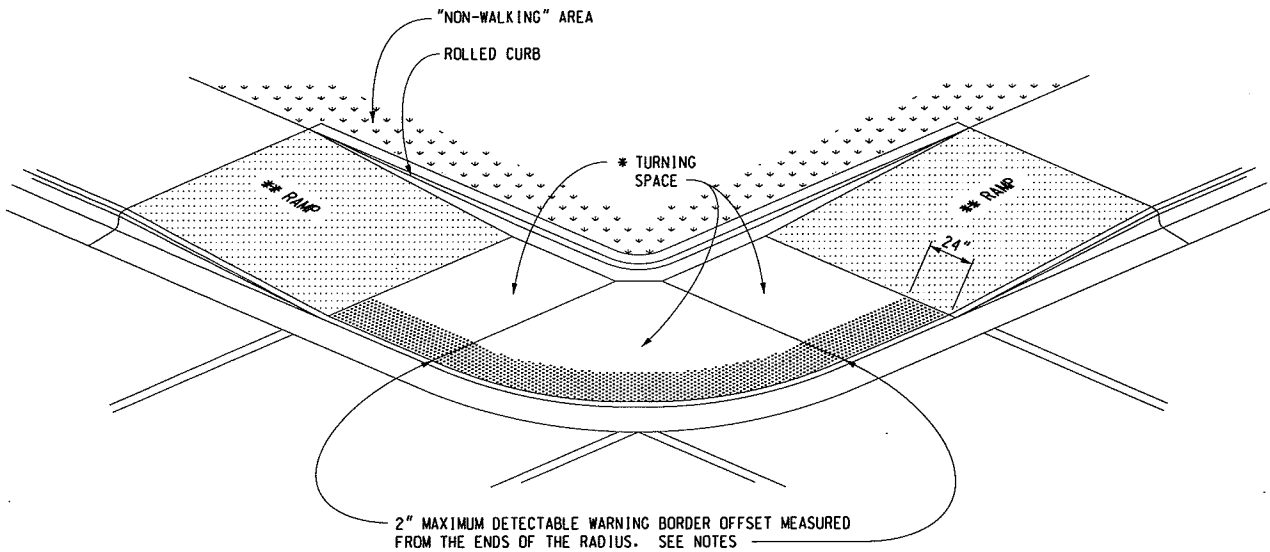

(RADIAL DETECTABLE WARNING SHOWN)

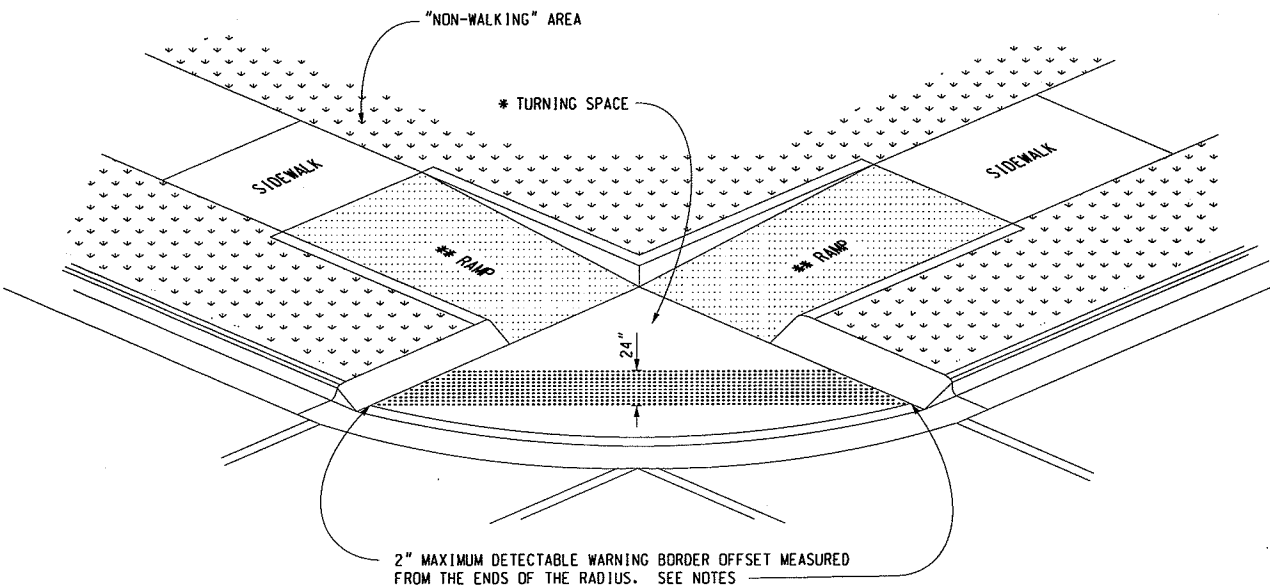

(TANGENT DETECTABLE WARNING SHOWN)

SIDEWALK RAMP TYPE D
(DEPRESSED CORNER)

USE ONLY WHEN INDEPENDENT DIRECTIONAL RAMPS CAN NOT BE CONSTRUCTED FOR EACH CROSSING DIRECTION

MICHIGAN DEPARTMENT OF TRANSPORTATION
BUREAU OF HIGHWAY DEVELOPMENT STANDARD PLAN FOR

**SIDEWALK RAMP AND
DETECTABLE WARNING DETAILS**

9-30-2014 F.H.W.A. APPROVAL	7-1-2014 PLAN DATE	R-28-I	SHEET 4 OF 7
--------------------------------	-----------------------	--------	-----------------

* THE DETECTABLE WARNING SURFACE SHALL BE LOCATED SO THAT THE EDGE NEAREST THE RAIL CROSSING IS 6' MINIMUM AND 15' MAXIMUM FROM THE CENTERLINE OF THE NEAREST RAIL. DO NOT PLACE DETECTABLE WARNING ON RAILROAD CROSSING MATERIAL.

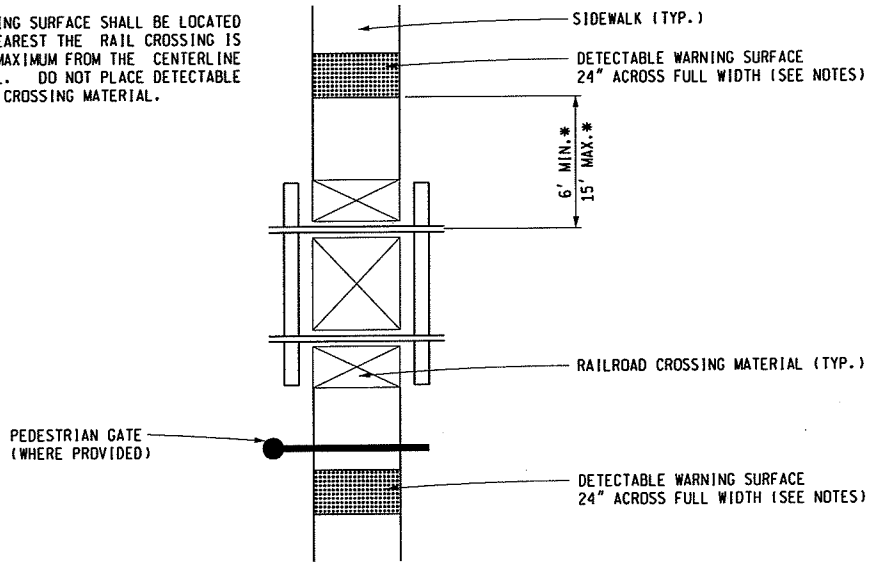

DETECTABLE WARNING AT RAILROAD CROSSING

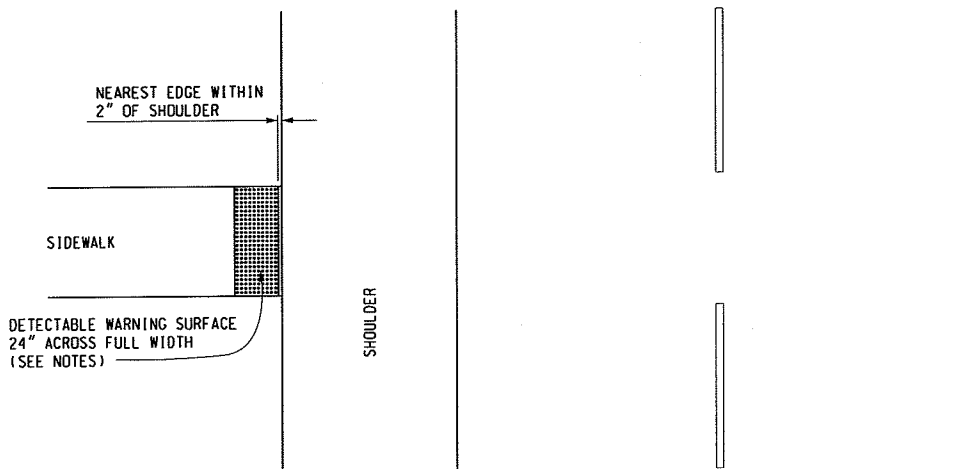

DETECTABLE WARNING AT FLUSH SHOULDER OR ROADWAY

MICHIGAN DEPARTMENT OF TRANSPORTATION
BUREAU OF HIGHWAY DEVELOPMENT STANDARD PLAN FOR

**SIDEWALK RAMP AND
DETECTABLE WARNING DETAILS**

9-30-2014
F.H.W.A. APPROVAL

7-1-2014
PLAN DATE

R-28-1

SHEET
5 OF 7

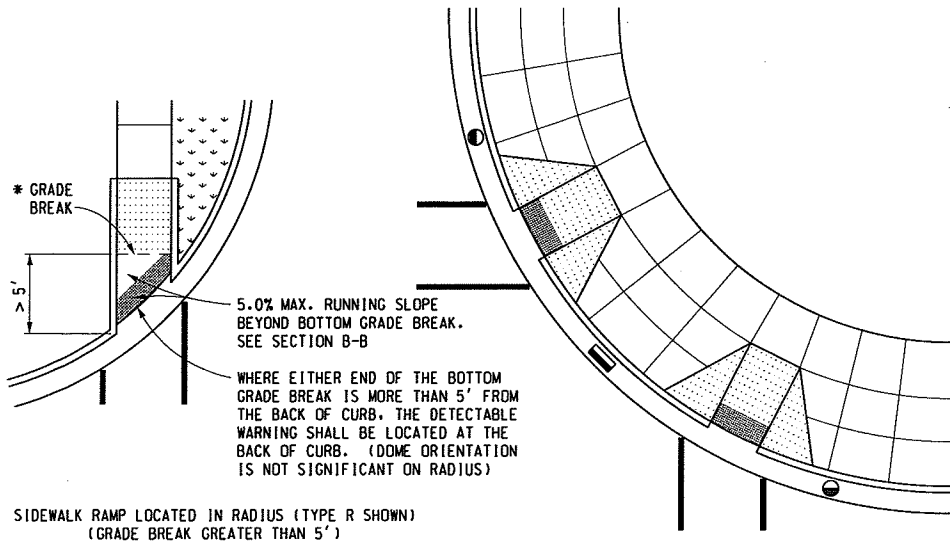

LEGEND	
	SLOPED SURFACE
	DETECTABLE WARNING
	"NON-WALKING" AREA
	CROSSWALK MARKING
	PREFERRED LOCATION OF DRAINAGE INLET (TYP.)
	ALTERNATE LOCATION OF DRAINAGE INLET (TYP.)

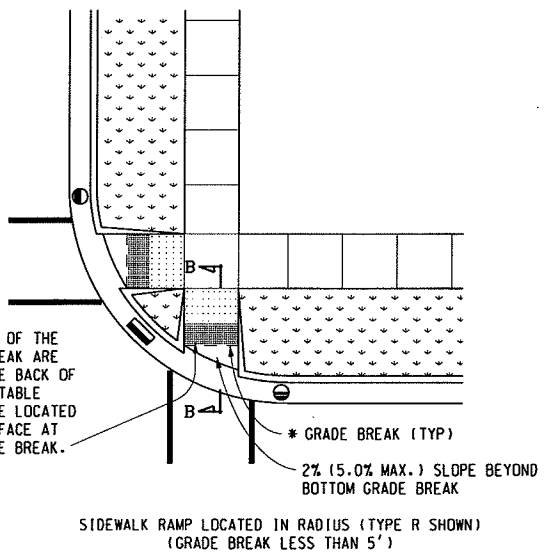
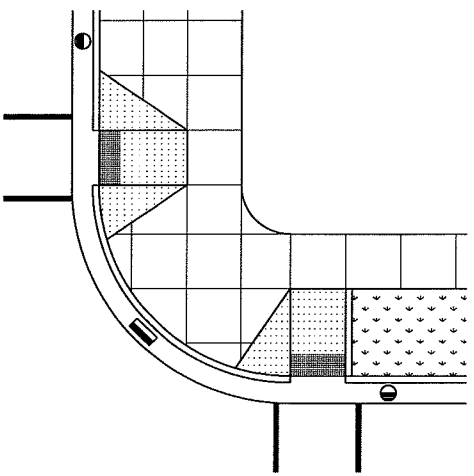

* GRADE BREAKS AT THE TOP AND BOTTOM OF CURB RAMPS SHALL BE PERPENDICULAR TO THE DIRECTION OF TRAVEL.

*** TRANSITION ADJACENT GUTTER PAN CROSS SECTION TO PROVIDE 5.0% MAXIMUM COUNTER SLOPE ACROSS THE RAMP OPENING.

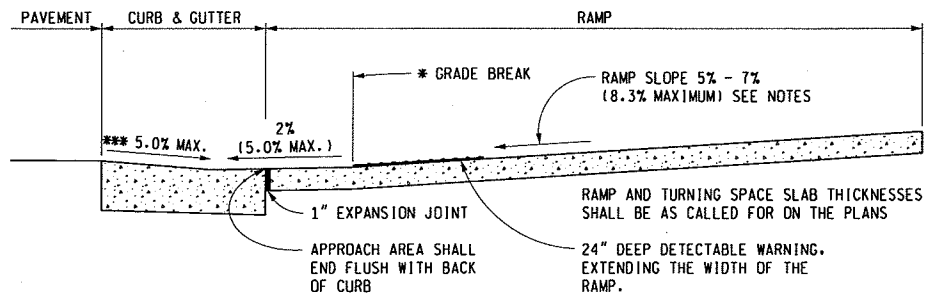

SECTION B-B
SIDEWALK RAMP ORIENTATION

MICHIGAN DEPARTMENT OF TRANSPORTATION
BUREAU OF HIGHWAY DEVELOPMENT STANDARD PLAN FOR

**SIDEWALK RAMP AND
DETECTABLE WARNING DETAILS**

9-30-2014 F.H.W.A. APPROVAL	7-1-2014 PLAN DATE	R-28-I	SHEET 6 OF 7
--------------------------------	-----------------------	--------	-----------------

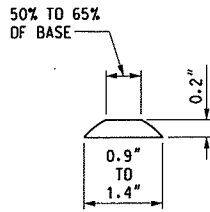

DOME SECTION

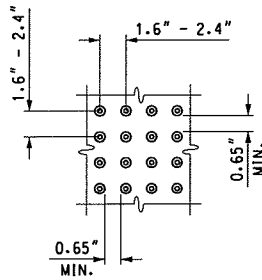

DOME SPACING

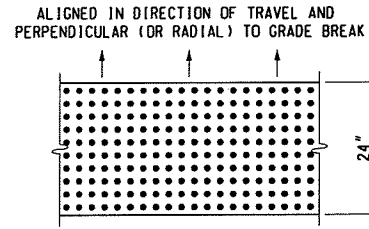

DOME ALIGNMENT

DETECTABLE WARNING DETAILS

NOTES:

DETAILS SPECIFIED ON THIS PLAN APPLY TO ALL CONSTRUCTION, RECONSTRUCTION, OR ALTERATION OF STREETS, CURBS, OR SIDEWALKS IN THE PUBLIC RIGHT OF WAY.

SIDEWALK RAMPS ARE TO BE LOCATED AS SPECIFIED ON THE PLANS OR AS DIRECTED BY THE ENGINEER.

RAMPS SHALL BE PROVIDED AT ALL CORNERS OF AN INTERSECTION WHERE THERE IS EXISTING OR PROPOSED SIDEWALK AND CURB. RAMPS SHALL ALSO BE PROVIDED AT MARKED AND/OR SIGNALIZED MID-BLOCK CROSSINGS.

SURFACE TEXTURE OF THE RAMP SHALL BE THAT OBTAINED BY A COARSE BROOMING, TRANSVERSE TO THE RUNNING SLOPE.

SIDEWALK SHALL BE RAMPED WHERE THE DRIVEWAY CURB IS EXTENDED ACROSS THE WALK.

CARE SHALL BE TAKEN TO ASSURE A UNIFORM GRADE ON THE RAMP, WHERE CONDITIONS PERMIT, IT IS DESIRABLE THAT THE SLOPE OF THE RAMP BE IN ONLY ONE DIRECTION, PARALLEL TO THE DIRECTION OF TRAVEL.

RAMP WIDTH SHALL BE INCREASED, IF NECESSARY, TO ACCOMMODATE SIDEWALK SNOW REMOVAL EQUIPMENT NORMALLY USED BY THE MUNICIPALITY.

PROVIDE TURNING SPACES WHERE PEDESTRIAN TURNING MOVEMENTS ARE REQUIRED.

WHEN 5' MINIMUM WIDTHS ARE NOT FEASIBLE, RAMP WIDTH MAY BE REDUCED TO NOT LESS THAN 4' AND TURNING SPACES TO NOT LESS THAN 4' x 4'.

DETECTABLE WARNING SURFACE COVERAGE IS 24" MINIMUM IN THE DIRECTION OF RAMP/PATH TRAVEL AND THE FULL WIDTH OF THE RAMP/PATH OPENING EXCLUDING CURBED OR FLARED CURB TRANSITION AREAS. A BORDER OFFSET NOT GREATER THAN 2" MEASURED ALONG THE EDGES OF THE DETECTABLE WARNING IS ALLOWABLE. FOR RADIAL CURB THE OFFSET IS MEASURED FROM THE ENDS OF THE RADIUS.

FOR NEW ROADWAY CONSTRUCTION, THE RAMP CROSS SLOPE MAY NOT EXCEED 2.0%. FOR ALTERATIONS TO EXISTING ROADWAYS, THE CROSS SLOPE MAY BE TRANSITIONED TO MEET AN EXISTING ROADWAY GRADE. THE CROSS SLOPE TRANSITION SHALL BE APPLIED UNIFORMLY OVER THE FULL LENGTH OF THE RAMP.

THE MAXIMUM RUNNING SLOPE OF 8.3% IS RELATIVE TO A FLAT (0%) REFERENCE. HOWEVER, IT SHALL NOT REQUIRE ANY RAMP OR SERIES OF RAMPS TO EXCEED 15 FEET IN LENGTH.

DRAINAGE STRUCTURES SHOULD NOT BE PLACED IN LINE WITH RAMPS. THE LOCATION OF THE RAMP SHOULD TAKE PRECEDENCE OVER THE LOCATION OF THE DRAINAGE STRUCTURE. WHERE EXISTING DRAINAGE STRUCTURES ARE LOCATED IN THE RAMP PATH OF TRAVEL, USE A MANUFACTURER'S ADA COMPLIANT GRATE. OPENINGS SHALL NOT BE GREATER THAN 1/2". ELONGATED OPENINGS SHALL BE PLACED SO THAT THE LONG DIMENSION IS PERPENDICULAR TO THE DOMINANT DIRECTION OF TRAVEL.

TRANSITION THE GUTTER PAN CROSS SECTION SUCH THAT THE COUNTER SLOPE IN THE DIRECTION OF RAMP TRAVEL IS NOT GREATER THAN 5.0%. MAINTAIN THE NORMAL GUTTER PAN CROSS SECTION ACROSS DRAINAGE STRUCTURES.

THE TOP OF THE JOINT FILLER FOR ALL RAMP TYPES SHALL BE FLUSH WITH THE ADJACENT CONCRETE.

CROSSWALK AND STOP LINE MARKINGS, IF USED, SHALL BE SO LOCATED AS TO STOP TRAFFIC SHORT OF RAMP CROSSINGS. SPECIFIC DETAILS FOR MARKING APPLICATIONS ARE GIVEN IN THE "MICHIGAN MANUAL OF UNIFORM TRAFFIC CONTROL DEVICES".

FLARED SIDES WITH A SLOPE OF 10% MAXIMUM, MEASURED ALONG THE ROADSIDE CURB LINE, SHALL BE PROVIDED WHERE AN UNOBSTRUCTED CIRCULATION PATH LATERALLY CROSSES THE SIDEWALK RAMP. FLARED SIDES ARE NOT REQUIRED WHERE THE RAMP IS BORDERED BY LANDSCAPING, UNPAVED SURFACE OR PERMANENT FIXED OBJECTS, WHERE THEY ARE NOT REQUIRED. FLARED SIDES CAN BE CONSIDERED IN ORDER TO AVOID SHARP CURB RETURNS AT RAMP OPENINGS.

DETECTABLE WARNING PLATES MUST BE INSTALLED USING FABRICATED OR FIELD CUT UNITS CAST AND/OR ANCHORED IN THE PAVEMENT TO RESIST SHIFTING OR HEAVING.

MICHIGAN DEPARTMENT OF TRANSPORTATION
BUREAU OF HIGHWAY DEVELOPMENT STANDARD PLAN FOR

SIDEWALK RAMP AND
DETECTABLE WARNING DETAILS

9-30-2014 F.H.W.A. APPROVAL	7-1-2014 PLAN DATE	R-28-I	SHEET 7 OF 7
--------------------------------	-----------------------	--------	-----------------

1) MIN. 2" X 2" CEDAR TREATED LUMBER, MARKED (SANITARY-RED., STORM-WHITE), SET VERTICALLY.

2) CAP WITH SOLVENT WELDED CAP OR PLUG

3) CLASS "X" CONCRETE TO EXTEND MIN. 1.0' BEYOND TEE OR WYE JOINTS. (D.I.P. TEE OR WYE NOT ENCASED)

4) CLASS II GRANULAR MATERIAL, COMPACTED TO 95% MAXIMUM DENSITY PER CITY OF ANN ARBOR STANDARDS.

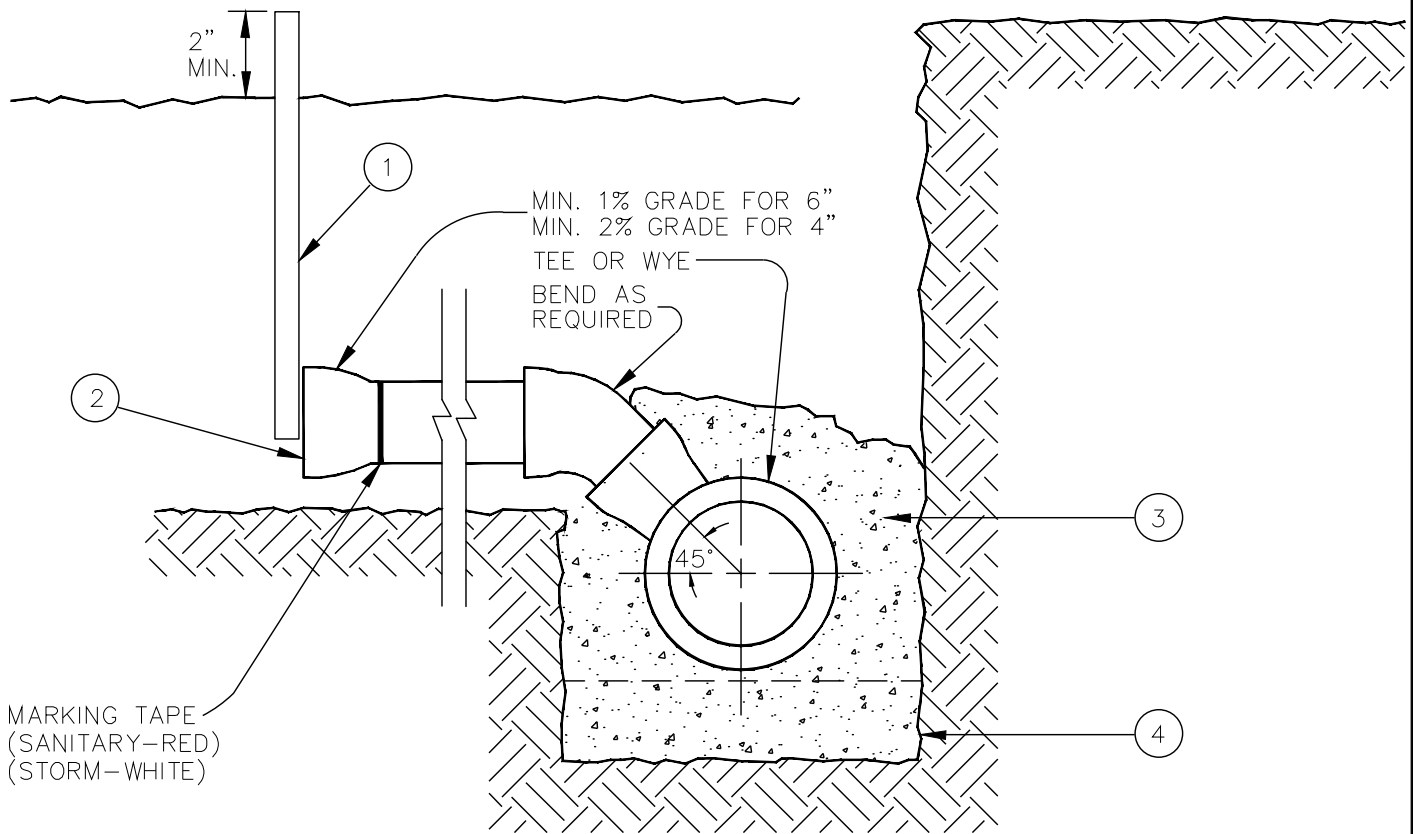

MARKING TAPE (SANITARY-RED) (STORM-WHITE)

NOTE: TAPS INTO EXISTING SEWERS SHALL BE DONE ONLY BY CITY UTILITIES DEPARTMENT.

REVISIONS					REV. NO.	DR. BY	CH. BY	DATE
PUBLIC SERVICES DEPARTMENT CITY OF ANN ARBOR								
SEWER CONNECTION								
DR. BY	DF/DCO	CH. BY	CSS/DF	DRAWING NO.				
SCALE	NONE	DATE	11-6-92	SD-S-6				
INCH	0  1			SHEET NO. ____ OF ____				

1) CARRY TO WITHIN 8' TO 10' OF GROUND ELEVATION.

2) MIN. 2" x 2" CEDAR OR TREATED WOOD MARKER, MARKED (SANITARY-RED, STORM-WHITE), SET VERTICALLY.

3) CAP WITH SOLVENT WELDED CAP OR PLUG.

4) CLASS "X" CONCRETE TO EXTEND MIN. 1.0' BEYOND TEE JOINTS (D.I.P. TEE NOT ENCASED)

5) CLASS II MATERIAL, COMPACTED TO 95% MAXIMUM DENSITY PER CITY OF ANN ARBOR STANDARD SPECIFICATIONS.

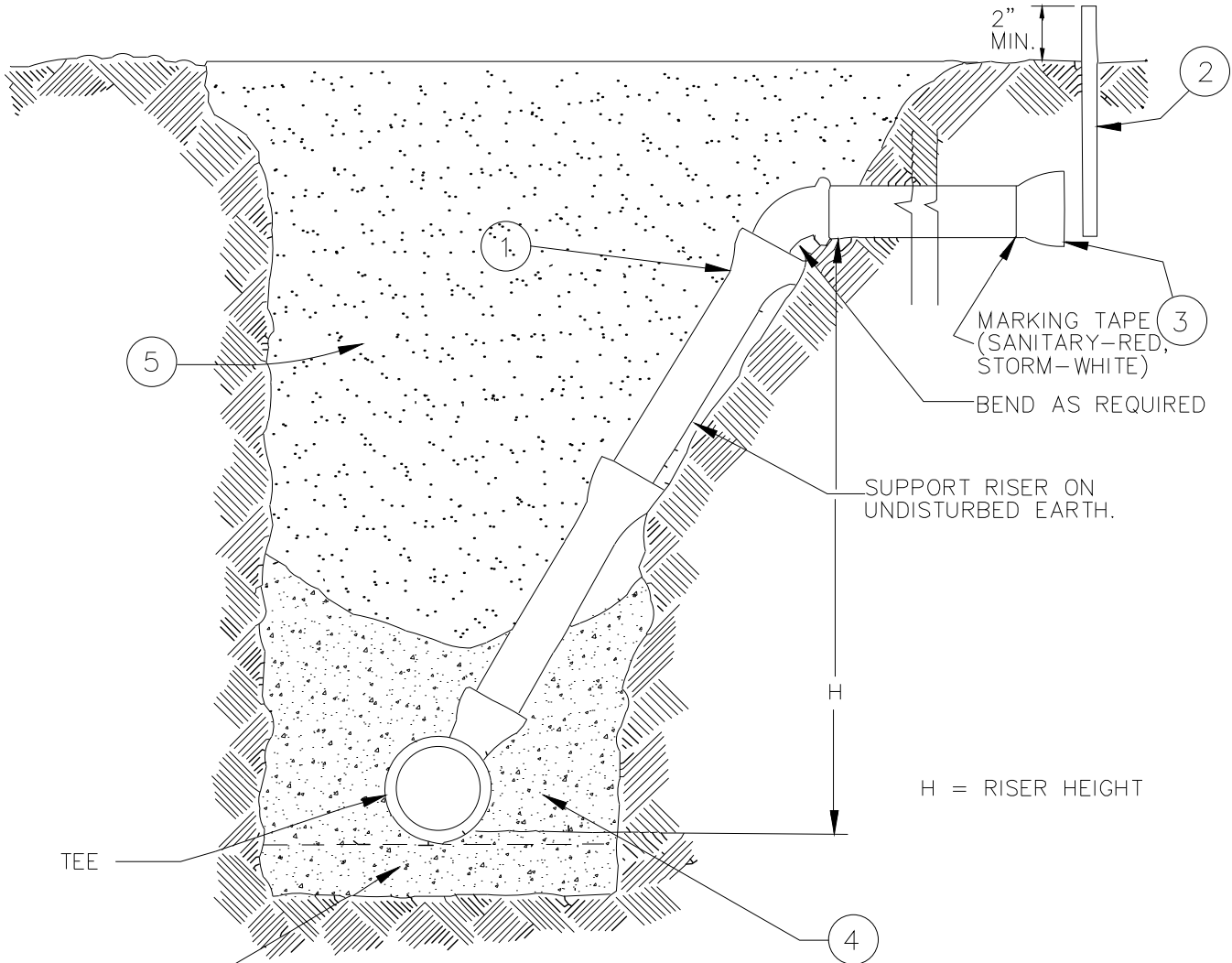

NOTE: A TEE SHALL BE USED AT THE SEWER MAIN IF A RISER IS USED. WYES ARE NOT TO BE USED.

REVISIONS		REV. NO.	DR. BY	CH. BY	DATE
PUBLIC SERVICES DEPARTMENT					
CITY OF ANN ARBOR					
SANITARY SEWER CONNECTION WITH RISER					
DR. BY	DF	CH. BY	CSS	DRAWING NO.	
SCALE	NONE	DATE	11-6-92	SD-S-7	
INCH	0  1			SHEET NO. ____ OF ____	

MICHIGAN
DEPARTMENT OF TRANSPORTATION

SUPPLEMENTAL SPECIFICATION
FOR
ERRATA TO THE 2012 STANDARD SPECIFICATIONS

1 of 29

07-31-15

Page	Subsection	Errata
3	101.02	Modify the abbreviation reading "AIS" to read "AIS1".
4	101.02	Delete the following abbreviations and the long forms MDELEG MDNRE Add the following abbreviations and the long forms MDNR Michigan Department of Natural Resources MDEQ Michigan Department of Environmental Quality MDLARA Michigan Department of Licensing and Regulatory Affairs NESC National Electrical Safety Code
27	103.02.B.2	Change the last sentence of the first paragraph to read "For decreases below 75 percent, the maximum allowable payment for work performed, including any adjustment, will not exceed an amount equal to 75 percent of the original contract quantity times the contract unit price."
34	104.05	The first sentence of this subsection should read "If the Contractor performs unauthorized work (work performed without the inspections required by the contract, extra work performed without Department approval, work performed contrary to the inspectors direction, or work performed while under suspension by the inspector), the Engineer may reject the unauthorized work."
46	104.12	Add the following to the end of the first paragraph "The use of right-of-way in wetlands and floodplains, or the crossing of water courses by construction equipment is prohibited."
53	105.09	Add the following to the end of the second paragraph "Any specifically produced material not purchased by the Department, will remain the Contractors and must be removed from the project prior to final acceptance."
56	107.02.B.2	This sentence should read "U.S.Army Corps of Engineers' Section 404, Dredge and Fill; and Section 10, Navigable Waterway."
56	107.02.B	Add the subsection reading as follows: "3. U.S. Coast Guard Section 9, Navigable Waterway." Change "MDNRE" to "MDEQ" in this subsection.

Page	Subsection	Errata		
64	107.12	Change the first sentence of the first paragraph to read: "For protection of underground utilities and in accordance with 2013 PA 174, the Contractor must notify Miss Dig at least 3 work days, excluding Saturdays, Sundays and holidays, before beginning each excavation in areas where public utilities have not been previously located."		
65	107.15.A	Change "MDNRE" to "MDEQ" in four instances in this subsection.		
66	107.15.A.3	Add the following to the end of the paragraph "Note that a burn permit from the MDNR is required for any open burning whenever the ground is not snow covered. Any individuals that allow a fire to escape will be in violation of the Natural Resources and Environmental Protection Act and will be required to reimburse the costs of suppressing the wild fire."		
67*	107.16	The third sentence should read "In State Forests, the Contractor must contact the local Unit Manager, Forest Management Division, MDNR, regarding the work to be performed within or adjacent to the forest land." Delete the last sentence of the first paragraph of this subsection.		
83	108.10.C.1	In Table 108-1 delete the last row of the table and replace it with the following: <table data-bbox="570 978 1219 1010"> <tr> <td data-bbox="570 978 732 1010">≥50,000,000</td> <td data-bbox="1143 978 1219 1010">4,500</td> </tr> </table>	≥50,000,000	4,500
≥50,000,000	4,500			
107	150.04	Change the following pay item reading "Mobilization, Max ___" to read "Mobilization, Max (dollar)" at nine locations throughout the subsection.		
112	201.03.A.3.b	Change "MDNRE" to "MDNR" in three instances in this subsection.		
150	208.01	Change "MDNRE" to "MDEQ" in this subsection.		
180	308.03.A	Change the first sentence of the second paragraph to read: "Do not operate equipment required to place backfill directly on geotextile products."		
185	401.03.A	Change the first sentence of the second paragraph to read: Where unstable soil conditions, or obstructions other than rock, require excavation of the trench below the elevation detailed on the plans; undercut, backfill, and compact the trench as directed by the Engineer.		
188	401.03.H	Change the second sentence of the paragraph to read "Jack steel pipes in place in accordance with subsection 401.03.G".		
189	401.03.N	Add the following sentence to the end of the first paragraph "Where possible, maintain the stream flow thru a temporary channel or temporary culvert."		

Page	Subsection	Errata
		The second sentence of the second paragraph should read "Direct water from the dewatering operations through a filter bag before discharging to an existing drainage facility."
190	401.04	Change the fourth pay item from the end of the list to read as follows: "Steel Casing Pipe, __ inch, Tr Det __."
200	402.04	Change the third pay item from the top of the list to read as follows: "Sewer, CI __, __ inch, Jacked in Place"
201*	402.04.H	Change the last sentence of the first paragraph to read "The Department will not make an adjustment in the pay items of Minor Traf Devices or Traf Regulator Control ."
208	403.04.D.3	Change the sentence to read: "Removing and replacing pavement adjacent to the adjusted cover per Standard Plan R-37 Series."
218	406.03.A.2	Change the first sentence of the first paragraph to read: "Design precast box culverts less than 10 feet in span length measured along the centerline of the roadway in accordance with current AASHTO LRFD Bridge Design Specifications and ASTM C 1577." Add the following sentence to the end of the first paragraph: "Design precast box culverts greater than or equal to 10 feet in span length measured along the centerline of the roadway for HL-93 Modified live load."
219	406.03.B	Change the first sentence of the first paragraph to read: "Submit shop drawings for culverts greater than or equal to 10 feet in span length measured along the centerline of the roadway to the Engineer, for review and approval in accordance with subsection 104.02."
219	406.03.C.1	Change the second sentence of the first paragraph to read: "Before manufacture, perform load ratings on precast three-sided, arch or box culverts greater than or equal to 10 feet in span length measured along the centerline of the roadway, in accordance with the AASHTO Manual of Bridge Evaluation, Section 6, Part A, the Michigan Bridge Analysis Guide current at the time load rating is performed, and the Michigan Structure Inventory and Appraisal Guide."
223	406.03.G	Add the following after the first sentence of the second paragraph: "Where possible, maintain the stream flow thru the existing channel, temporary channel, or temporary culvert."
224	406.03.G	Replace the fifth paragraph of this subsection with the following: "The Contractor may use cast-in-place wing walls, headwalls, and aprons, as alternatives to precast wing walls, headwalls, and aprons."

Page	Subsection	Errata
		Attach cast-in-place wing walls or headwalls as shown on the shop drawings."
225	406.03.G.2	Change the third sentence of the first paragraph to read: "Before placing the open-graded aggregate 34R, compact the coarse aggregate 6A using at least three passes of a vibrating plate compactor."
226	406.03.G.2	Change the first sentence of the second paragraph of this subsection to read: "Fill the space between the box culvert joints during placement of box sections with closed-cell rubber extrusion type gaskets in accordance with ASTM C 990."
226	406.04.A.9	Change the sentence to read: "Providing plan modifications including design, additional plan quantities and pay items to accommodate any changes to the precast units as shown on the plans."
226*	406.04.A	Add the following paragraph after the last paragraph of the subsection: "The substructure design is specific to the three-sided or arch culvert detailed on the plans. The Contractor must use approved MDOT service vendors qualified in Hydraulics, Geotechnical Engineering Services, and Short and Medium Span Bridges to perform the required design and plan modifications, as directed by the Engineer, if the Contractor selects a culvert shape different than shown on the plans."
227	406.04.B	Add the following new item in the list of items in this subsection: 2. Headwalls, wingwalls, aprons, and curtain walls, precast or cast-in-place; Renumber the exist items 2 through 4 in this list to read 3 through 5. Delete existing item numbered 5 and replace with the following: 6. Inserts for bars and connection hardware; and Renumber the existing item 6 in this list to read 7.
227	406.04.B	Delete the first and second paragraphs following the list of items in this subsection and replace with the following: "The Department will pay separately for cast-in-place concrete, other than for culvert segments, wing walls, and headwalls; excavation; protective coating; providing and placing backfill material; by plan quantity in accordance with subsection 109.01.A."
239	501.03.C.6	The first sentence of this subsection should read "Except as specified in subsection 501.03.C.4, removing HMA surface applies to removing HMA overlying a material designated for removal or that is required to remain in place."

Page	Subsection	Errata
247	501.03.O	Change footnote e in Table 501-5 to read: "Flushing severe enough to significantly affect surface friction (Friction Number <35)."
249	501.04.H	The first sentence of this subsection should read "The Engineer will measure, and the Department will pay for removing HMA surface, no greater than 12 inches thick, overlying a material designated for removal or that is required to remain in place, as HMA Surface, Rem. " The second paragraph of this subsection should read "The Engineer will measure, and the Department will pay for removing HMA surface, greater than 12 inches thick, overlying a material designated for removal or that is required to remain in place, as Pavt, Rem in accordance with subsection 204.04."
257	503.03.E	Delete this subsection in its entirety.
265	504.03.E.3	Delete this subsection in its entirety.
269	504.04.A	This subsection should read "The unit prices for Micro-Surface , regardless of the type required, include cleaning existing pavement; applying a bond coat; temporary pavement markings; stationing; corrective action; and traffic control to complete corrective action."
299	601.04	In table 601-2 delete the row for Grade P-NC concrete in its entirety.
300	601.04	In table 601-2, the first sentence of footnote b. should read: "Use coarse aggregate 6A, 6AA or 6AAA for Grades P1, P2 and M." In table 601-2, footnote c. should read: "The mix design basis for bulk volume (dry, loose) of course aggregate per unit volume of concrete is 72% for Grade P1; 74% for Grade P2."
308	602.03.F	Note c. in Table 602-1 should read "Refer to Section D6 of the Materials Quality Assurance Procedures Manual for inspection procedure."
320	602.04.C.3	The last paragraph in this subsection should read "If the Engineer approves a substitution of a higher concrete grade for a lesser grade (e.g., P1 for P2), the Department will pay for the higher grade of concrete using the original bid and pay items of the lesser grade."
327	603.02	Change the second material in the list to read: "Concrete, Grade P-NC.....603" Change the third material in the list to read: "Base Course Aggregate, 4G, 21AA, 22A.....902"
334	603.03.B.10	Change the last sentence of the second paragraph to read "Apply the required curing compound in two coats, at a rate of at least 1 gallon per 25 square yards for each coat."

Page	Subsection	Errata
342	603.04.G.3	Change "D1" to "W" in two instances in this subsection.
351	701.04	Replace Tables 701-1A and 701-1B with the Table 701-1 below.
372	705.03.C.1	Add the following sentence after the first paragraph of this subsection: "Do not drive piles within a radius of 25 feet of newly placed concrete until the concrete attains at least 75 percent of its specified minimum strength."
374	705.03.C.2.c	Change the last sentence of the second paragraph to read "Drive test piles to the minimum pile length or practical refusal, whichever is greater".
379	705.04	Change the fifth item down the list to read: "Pile, Galv (Structure No.)"
380	705.04	Change the last item in the list to read: "Pile Driving Equipment, Furn (Structure No.)"
383	706.02	The fourth paragraph following the list of materials should read "Provide AASHTO M 270, Grade 36 steel, meeting the requirements of ASTM A 786, galvanized in accordance with section 707, for expansion joint cover plates. Provide plates at least 3/8 inch thick. Use plates with a slip resistance equal to or greater than those meeting the requirements of ASTM A 786 and must be approved by the Engineer. Provide ASTM F 593 (Type 304) stainless steel, 3/4-inch or 1/2-inch diameter, flathead countersunk screws with 3/4-inch or 1/2-inch diameter inserts for use in expansion joint cover plates."
389	706.03.D.4.b	Change the first sentence of the fourth paragraph to read "Design forms, form supports, and attachments to carry dead loads, and resultant horizontal loads due to forming of cantilever overhangs."
391	706.03.E.8	Change the first sentence of the second paragraph of this subsection to read: "Patch sawed or sheared ends and visible defects in accordance with ASTM A 775."
392	706.03.E.8	Change the last sentence of the third paragraph of this subsection to read: "Coat mechanical splices after splice installation in accordance with ASTM A 775 for patching damaged epoxy coating."
394	706.03.H.1	Delete the last paragraph on page 394 and replace it with the following: "Do not cast sidewalk, curb, or barrier pours until the deck concrete attains at least the minimum specified 7-day flexural or compressive strength, and after completion of the 7-day continuous wet cure. The forming of succeeding portions may occur, provided the wet cure is maintained."

Page	Subsection	Errata
406*	706.03.N.1.b	Add the following to the end of the last paragraph of the subsection: “Do not discontinue wet cure nor cast succeeding portions onto the bridge deck prior to completion of the 7-day two-phase continuous wet cure. Ensure excess or ponding cure water is removed prior to casting of succeeding structure portions.”
414	707.01.B	Change the last sentence of the first paragraph to read "For horizontally curved or continuous span or cantilevered span girders the Engineer will consider intermediate cross frames and connection plates and stiffeners as primary members."
416	707.03.C.1	Change the title of the subsection from “Shop Plans to read “Shop Drawings”. Change the second sentence of this subsection to read: “Do not use design drawings in lieu of shop drawings.”
426	707.03.C.17	Change the second sentence in the first paragraph of this subsection to read: "Tap oversized galvanized nuts in accordance with ASTM A 563 or AASHTO M 292 and meet Supplementary Requirement S1 of ASTM A 563 or AASHTO M 292."
430	707.03.D.7.b	Delete the first sentence of the last paragraph of this subsection.
430*	707.03.D.7.b	Change the title of the Table 707-4 to read: "Minimum Bolt Tension for ASTM A 325 Bolts"
430	707.03.D.7.b	Change "104,000" to "103,000" in the last row under the column titled Minimum Bolt Tension.
431	707.03.D.7.c	Add the following sentence to the end of the first paragraph of this subsection: “If using impact wrenches, provide wrenches sufficient to tighten each bolt in approximately 10 seconds.”
431*	707.03.D.7.c	Change the first sentence of the second paragraph to read: "Do not reuse ASTM A 325 bolts and nuts."
434	707.04.A	Change the first sentence of the first paragraph of this subsection to read: “The Engineer will measure structural steel by the calculated weight of metal in the finished structure, excluding filler metal in welding, as shown on the shop drawings or working drawings.”
438	708.03.A.2	Change the title of the subsection from “Shop Plans to read “Shop Drawings”.

Page	Subsection	Errata
		Change the first sentence to read: "Submit shop drawings in accordance with subsection 104.02."
		Change the fourth sentence to read: "Do not start production until the Engineer approves the shop drawings."
441*	708.03.A.11	Change the last sentence of the first paragraph to read "Cure concrete at temperatures from 70 °F to 150 °F until concrete attains the release strength shown on the shop drawings".
441	708.03.A.11	Change the fourth sentence of the fourth paragraph to read "Do not exceed a maximum concrete temperature of 150 °F during the curing cycle."
458	711.03.A	Change the first sentence in the first paragraph to read: "Shop drawings for structural steel and pipe railings are not required."
460	711.04.A	Change the second sentence of the first paragraph to read: "The unit price for Bridge Barrier Railing includes the cost of placing steel reinforcement, providing and placing concrete, constructing joints, and forming, finishing, curing and protecting the concrete."
461	711.04.F	The title of this subsection should read " Reflective Marker, Permanent Barrier. "
467	712.03.C	Add the following to the end of the third paragraph of the subsection: "Notify the Engineer of any saw cuts in the top flange. Saw cuts equal to or less than 1/32 inch deep in steel beams must be repaired by grinding, to a surface roughness no greater than 125 micro-inches per inch rms, and tapering to the original surface using a 1:10 slope. Saw cuts in excess of 1/32 inch deep in steel beams require a welded repair to be submitted to the Engineer for approval. Weld in accordance with subsection 707.03.D.8 and provide adequate notice to allow the Engineer to witness the repair work. Inspect and test all saw cut repairs (including grinding repairs) using ultrasonic testing in accordance with 707.03.D.8.c at no additional cost to the Department."
471	712.03.J	Add the following to the end of the second paragraph of the subsection: "Select adhesive anchor systems from the Qualified Products List."
471	712.03.J.1	Delete the first paragraph in this subsection and replace it with the following: "Propose complete details of drilling, cleaning, and bonding systems for anchoring reinforcement and submit for the Engineer's approval before use. The minimum embedment depth must be nine times the anchor diameter for threaded rod or bolt and twelve times the anchor diameter for reinforcing bar. Propose a drilling method that does not cut or damage existing reinforcing steel. Prepare at least three proof tests per anchor diameter and type in the same orientation in which they will be installed on the existing structure, on a separate concrete block, in the presence of the Engineer. The Engineer will proof test the

Page	Subsection	Errata
		proposed systems. The Engineer will base approval of the anchoring system on the following criteria:"
471	712.03.J.2	Change the third sentence of the first paragraph to read: "Use a tension testing device for unconfined testing, in accordance with ASTM E 488."
473	712.03.L.2	Change the first sentence in the second paragraph of this subsection to read: "If using epoxy coated steel reinforcement, epoxy coat mechanical reinforcement splices in accordance with ASTM A 775."
473	712.03.L.3	Delete the existing first sentence in the first paragraph.
473	712.03.L.3	Change the third sentence of the first paragraph to read "Provide two test splices on the largest bar size."
473*	712.03.L.3	Change the sentence beginning "Demonstrate to the... to read: "Demonstrate to the Engineer that splices have a tensile strength of 125 percent of the bar yield strength and high strength splices have a tensile strength of 150 percent of the bar yield strength."
488	713.02	Add the following as subsection 713.02.C: "C. Structural Steel for Retrofitting and Welded Repairs. Structural steel material used for retrofitting and welded repairs of primary members as defined in subsection 707.01.B must meet longitudinal Charpy V-Notch impact test requirements."
501	715.02	Add the following material reference above the two existing items: "Sealant for Perimeter of Beam Plates.....713"
508	715.03.D.1	Add the following sentence after the second paragraph of the subsection: "Apply sealant for perimeter of beam plates in accordance with subsection 713.03.F."
515	716.03.A	Delete the second paragraph of this subsection in its entirety. Change the last sentence of the last paragraph of this subsection to read: "Provide a primer dry film thickness for the top flange between 4 mils and 10 mils."
519	716.04	Change the second sentence of the first paragraph of this subsection to read: "The unit price for Field Repair of Damaged Coating (Structure No.) includes the costs of making field repairs to the shop applied coating system; prime coat surfaces and exposed surfaces of bolts, nuts, and washers; and repairing stenciling."

Page	Subsection	Errata
521	717.04.B	This subsection should read "The unit price for Drain Casting Assembly includes the cost of providing and installing the downspout and, if necessary, the lower bracket to the drain casting."
522	718.02	Change the section number "906" in the third material in the list to read "919."
533	718.04	Delete the following pay item from the list: Temp Casing.....Foot
533	718.04.B.2	Delete this subsection in its entirety.
533	718.04.B.3	Renumber this subsection as follows: "2. Permanent Casing. "
540	802.04	Change "Non reinf" in the last pay item of the list with "Nonreinf".
545*	803.04.E	Change the second sentence of the second paragraph to read: "The unit price for Railing for Steps includes the cost of providing, fabricating, installing, and grouting the railing."
560	807.04	Delete the following pay item from the list: Guardrail Buffered EndEach
560	807.04.B	Change the fifth paragraph of this subsection to read: "The Engineer will measure Guardrail Salv and Guardrail, Mult, Salv along the face of the rail (one face for multiple beams), including terminals and end shoes."
567	808.04.C	Change the first paragraph of this subsection to read: "The Department will not pay separately for protective fence required in accordance with subsection 104.07."
569	809.04.A	Change the first sentence to read: "The unit price for Field Office, CI ___ includes the cost of setup, providing access, grading, maintaining, plowing snow, and utility hook-up charges."
570	809.04.B	Delete the existing second and third sentences in the first paragraph and replace them with the following: "The unit price for Field Office, Utility Fees includes the cost of monthly usage fees for electricity, gas, telephone service and charges, fuel for the stove, monthly water and sanitary service."
570	809.04.B	Change the existing fourth sentence in the first paragraph to read: "The Department will reimburse the Contractor for monthly usage fees for electricity, gas, telephone, water and sanitary charges incurred by the Department."
575	810.03.K	Change the subsection to read

Page	Subsection	Errata
		"K. Drilled Piles for Cantilever and Truss Foundations. Construct drilled piles for cantilever and truss foundations in accordance with section 718."
578	810.03.N.2	Add the following sentence after the first sentence of the second paragraph on this page: "Mark each nut and bolt to reference the required rotation."
584	810.04	Delete the last pay item in the list: Truss Fdn Anchor Bolts, Replace.....Each
596	811.03.G	Delete this subsection in its entirety.
597*	811.03.H	Rename this subsection as follows: "G. Raised Pavement Marker (RPM) Removal. "
597*	811.04	Change "Crosshatching" in the last pay item of the list on this page to "Cross Hatching".
598*	811.04	Delete the following pay items from the list: Pavt Mrkg, (material), 4 inch, SRSM, (color).....Foot Pavt Mrkg, (material), 4 inch, SRSM, 2 nd Application, (color).....Foot Add the following pay items to the list: "Pavt Mrkg, Polyurea, (legend).....Each Pavt Mrkg, Polyurea, (symbol).....Each" Change the sixth item down the list to read: "Pavt Mrkg, Polyurea, __ inch, Cross Hatching, (color)" Change the eleventh item down the list to read: "Rem Curing Compound, for Longit Mrkg, __ inch.....Foot" Change the last item in the list to read: "Witness, Log, Layout, \$1000.00"
599	811.04.B	Delete this subsection in its entirety.
599	811.04	Rename the following subsections as follows: "B. Call Back. C. Pavement Marking Removal. D. Material Deficiency. "
602	812.03.D	Change the first sentence to read "Provide and maintain traffic control devices meeting the requirements in the ATSSA Quality Guidelines for Work Zone Traffic Control Devices and Features."
603	812.03.D.1	The last sentence on this page should read "Lay the sign behind the guardrail, with the uprights pointing downstream from the traffic, and place the support stands and ballasts close to the guardrail."

Page	Subsection	Errata
604	812.03.D.2	The first sentence of the fourth paragraph should read "Do not use burlap or similar material to cover Department or Local Government owned signs."
604	812.03.D.5	The fifth sentence of the first paragraph should read "Do not mix drums and cones within a traffic channeling sequence."
605	812.03.D.6.b	Change the first sentence of the first paragraph to read: "The Department will allow the nighttime use of 42-inch channelizing devices, in the tangent area only, on CPM and pavement marking of any duration where the use of plastic drums restricts proposed lane widths to less than 11 feet, including shy distance."
605	812.03.D.7	Add the following sentence after the first sentence of the first paragraph: "Place a shoulder closure taper in advance of the lighted arrows placed on the shoulders."
607	812.03.D.9	Delete the second paragraph of this subsection and replace with the following: "Link sections together to fully engage the connection between sections. Maintain the barrier with end-attachments engaged and within 2 inches of the alignment shown on the plans."
608	812.03.D.10.b	Add the following sentence after the first paragraph of this subsection: "Use an NCHRP 350, Test Level 3, or MASH accepted attenuation system."
608	812.03.D.10.b	Delete the second sentence of the second paragraph of this subsection beginning with "Install sand module attenuators..."
608	812.03.D.10.b	Add the following sentence after the second paragraph of this subsection: "Install impact attenuation devices as shown on the plans, as directed by the Engineer, or both."
609	812.03.D.10.d	Add the following sentence after the first paragraph of this subsection: "Use an NCHRP 350, Test Level 3, or MASH accepted attenuation system."
610	812.03.D.11.a	Change "Type R tape" to read "Type R marking" in three locations in this subsection.
613	812.03.D.14.a.iii	Change the sentence in this subsection to read "Place an ET Type or SKT Type extruder guardrail ending on both blunt guardrail ends."
615	812.03.F	The second sentence of the second paragraph of this subsection should read: "The Contractor may use a Type R temporary pavement marking cover, per subsection 812.03.D.12 when authorized by the Engineer."

Page	Subsection	Errata
616	812.03.F.2	The last sentence of the first paragraph should read: "If the removal equipment cannot collect all removal debris, operate a self-propelled sweeper capable of continuously vacuuming up the removal debris immediately behind the removal equipment."
617	812.03.G.3	The first sentence of the second paragraph should read: "Sweep the shoulder and remove debris prior to placing traffic on the shoulder and throughout the time the shoulder is used to maintain traffic."
617	812.03.G.4.a	Delete "48 inch by 48 inch" from the first sentence of this subsection.
618*	812.03.G.7	The first sentence of the first paragraph should read: "Clean barrier reflectors, plastic drums, 42 inch channelizing devices, tubular markers, signs, barricades, and attached lights in operation on the project to ensure they meet required luminosity."
619	812.03.G.8	The second sentence of the third paragraph from the end of the subsection should read: "Illuminate traffic regulator stations at night per subsection 812.03.H."
621	812.03.I.6	Delete "48 inch by 48 inch" from the second sentence of this subsection.
622*	812.03.J	The second paragraph should read "Apply one 2-inch wide horizontal stripe of red and white conspicuity tape along at least 50 percent of each side of, and across the full width of the rear of the vehicle or equipment."
622	812.04	Change the second item down the list to read: "Traf Regulator Control" Change the sixth item down the list to read: "Sign Cover, Type I"
626	812.04.I	Change the reference "812.04.E" in the first sentence to "812.04.D".
628	812.04.M.4	Add the following as the first sentence of this subsection: "The Engineer will not measure a temporary barrier ending move as Conc Barrier Ending, Temp, Relocated if it involves work defined in subsection 812.04.M.3."
629	812.04.N.1	Change the reference "811.04.D" in the second paragraph of this subsection to read "811.04.C".
630	812.04.S	Change the first sentence to read: "The Department will not make additional payments for traffic regulating, signing, arrow boards, and lighting systems for traffic regulator stations operated at night due to a temporary PTS system failure."
634	813.03.C.3	Change the reference "903.07.A" in the paragraph of this subsection to read "907.07.B".

Page	Subsection	Errata
646	815.04	Change the first, third and fourth pay items in the list to read: “Site Preparation, Max (dollar) Lump Sum Watering and Cultivating, First Season, Min (dollar)..... Lump Sum Watering and Cultivating, Second Season, Min (dollar) Lump Sum”
646	815.04.C.1	Change the following pay item reading: “Watering and Cultivating, First Season, Min. (dollar)” to read “Watering and Cultivating, First Season, Min (dollar)” at two locations throughout the subsection.
646	815.04.C.1.b	Delete this subsection in its entirety.
646	815.04.C.1.c	Rename this subsection to read: “b. Removal and disposal of unacceptable plants.”
646	815.04.C.2	Change the following pay item reading: “Watering and Cultivating, Second Season, Min. (dollar)” to read “Watering and Cultivating, Second Season, Min (dollar)” at three locations throughout the subsection.
647	815.04.C.2	Change the last paragraph of this subsection to read: “For each unacceptable plant identified, the Engineer will calculate a 50 percent reduction in the unit price for the relevant (Botanical Name) pay item, and will process a negative assessment for each unacceptable plant for that amount.”
650	816.03.B	Delete the first paragraph of this subsection and replace with the following: "Conduct soil tests when called for in the contract or when directed by the Engineer. Provide soils tests results to the Engineer when testing is required. Provide and place fertilizer as indicated below and as indicated in the soils tests, if required."
650	816.03.B.1	Change the sentence to read: "For Class A fertilizer, evenly apply 176 pounds of chemical fertilizer nutrient per acre on a prepared seed bed."
650	816.03.B.2	Change the sentence to read: "For Class B fertilizer, evenly apply 120 pounds of chemical fertilizer nutrient per acre on a prepared seed bed."
650*	816.03.B.3	Change the sentence to read: "For Class C fertilizer, evenly apply 80 pounds of chemical fertilizer nutrient per acre on established turf."
663*	819.01	Delete the first paragraph in the subsection and replace it with the following: “This work consists of providing operating electrical and lighting units; removing, salvaging, or disposing of existing electrical and lighting components; excavating, backfilling, restoring the site in accordance with section 816; and disposing of waste excavated materials. Complete this work in accordance with this section, section 820, and the contract and to the requirements of the NEC, the National Electrical

Page	Subsection	Errata
		Safety Code, and the MDLARA for those items not identified in the contract.”
		Change the third sentence of the second paragraph in this subsection to read: “Contact the MDLARA for electrical service inspection and pay the applicable fees.”
671	819.03.F.1	Change the paragraph to read: “Install light standard foundations as shown on the plans and the standard plans, as applicable.”
673	819.03.G.4.b	Change the last sentence of the first paragraph to read: "Tighten the anchor bolts to a snug tight condition as described in the third paragraph of subsection 810.03.N.2 ensuring the lock washer is completely compressed."
673	819.03.G.4.b	Delete the first two sentences of the second paragraph and replace with the following: "Tighten bolts connecting the pole to the frangible base to a snug tight condition. Snug tight is the tightness attained by a few impacts of an impact wrench, or the full effort of a person using an ordinary spud wrench. The lock washers must be fully compressed."
678*	819.04	Delete the last item in the list on this page reading: “DB Cable, in Conduit, 600 Volt, (number) 1/C# (size) Foot”
680	819.04	Change the first paragraph to read: “Unless otherwise required, the unit prices for the pay items listed in this subsection include the cost of excavation, granular material, backfill, and disposal of waste excavated material. If the contract does not include pay items for restoring the site in kind in accordance with section 816, the Department will consider the cost of restoration included in the pay items listed in this subsection.”
680	819.04.A	Add the following paragraph after the first paragraph of the subsection. “The unit prices for Conduit, Rem include the cost of removing the type, number, and size of conduit shown on the plans.” Change the third paragraph of the subsection to read: “The unit prices for Conduit, (type), __ inch and Conduit, DB, (number), __ inch include the cost of installing the type, number, and size of conduit shown on the plans, and installing marking tape.”
681	819.04.B	Change the last paragraph of the subsection to read: “The unit price for DB Cable, in Conduit, Rem includes the cost of removing all cables from the existing conduit measured per lineal foot of conduit.”
681	819.04.C	Change the first paragraph of the subsection to read:

Page	Subsection	Errata
		“The unit prices for Cable, Rem and Cable, (type), Rem include the cost of dead ending, circuit cutting, installing guying, work required to leave circuits operable, and disposing of the removed cables, wire, hardware, and other appurtenances.”
681	819.04.D	Change the first paragraph of the subsection to read: “The unit price for Cable, Pole, (type), Disman includes the cost of dismantling and off-site disposal of the following:”
685	820.01.D	Change the sentence to read: “Excavate, backfill, restore the site in kind in accordance with section 816, and dispose of excess or unsuitable material;”
688	820.03.C	Change the seventh paragraph of this subsection to read: “Tighten top anchor bolt nuts, snug, in accordance with the first four paragraphs of subsection 810.03.N.2, except beeswax will not be required.”
696	820.04	Add the following pay items to the list: “Pedestal, Pushbutton, Alum.....Each Pedestal, Pushbutton, Rem.....Each”
697	820.04.A.2	Change the sentence to read: “If the contract does not include pay items for restoring the site in kind in accordance with section 816, the Department will consider the cost of restoration included in the pay items listed in this subsection.”
698	820.04.B	Delete the second paragraph of this subsection found on this page.
698	820.04.C	Change " Fdns " to read " Fdn " in four instances in this subsection.
701	820.04.J.3	Change the sentence to read: "Installing wires in the saw slots and to the handholes;"
701.	820.04.J	Add the following as a new subsection: “7. A 3/4 inch minimum flexible conduit (non-metallic and rated for underground use) from the pavement to the handhole.”
706	821.01.B	Change the website address listed after the second paragraph on this page to read: “ http://www.ngs.noaa.gov/heightmod/GuidelinesPublications.shtml ”
711	822.03.B	Change the second paragraph to read: “If corrugations are required on concrete shoulders and the method of installation is not shown on the plans or directed by the Engineer, construct corrugations by grinding, or cutting.”
720	823.04	Change the pay item seventh from the bottom of the list to read: “Water Shutoff, Adj, Temp, Case ___”

Page	Subsection	Errata
730	824.03.Q	Change the third sentence of the fourth paragraph to read: "Ensure placement of monumentation in accordance with section 821."
730	824.03.Q	Change the first sentence of the last paragraph to read: "The Department will not pay for work dependent on lost or destroyed stakes until the Contractor replaces the stakes."
732	824.04	Change the first sentence of the first paragraph following the list of pay items to read: "If the Engineer determines the Contractor will perform staking as extra work, the Department will pay for staking in accordance with section 103."
733	824.04	Change the left column header in Table 824-2 to read: "Percent of Original Contract Amount Earned"
739	902.02	Change the last aggregate testing description to read: "Determining Specific Gravity and Absorption of Fine Aggregates.....MTM 321"
742	902.03.C.1.a	Change the sentence to read: "Coarse aggregate includes all aggregate particles greater than or retained on the 3/4-inch sieve."
742	902.03.C.2.a	Change the sentence to read: "Intermediate aggregate includes all aggregate particles passing the 3/4-inch sieve through those retained on the No. 4 sieve."
744	902.07	Delete the fourth paragraph of the subsection and replace it with the following: "The Engineer will only allow the use of granular material produced from crushed portland cement concrete for embankment and as trench backfill for non-metallic culvert and sewer pipes without associated underdrains. However, granular material produced from crushed portland cement concrete is not permitted as swamp backfill, nor within the top 3 feet below subgrade regardless of the application."
746*	902.11	Change the Item of Work by Section Number column in Table 902-1 for the 6AA row to read: "406, 601, 602, 706, 708, 806". Change the Item of Work by Section Number column in Table 902-1 for the 6A row to read: "206, 401, 402, 406, 601, 602, 603, 706, 806". Change the Item of Work by Section Number column in Table 902-1 for the 34R row to read: "401, 404, 406".
751*	902.11	Replace Table 902-6 with the Table 902-6 below.
751	Table 902-7	Under the Material column in the fourth row change the "FA2" to read "2FA".

Page	Subsection	Errata
751	Table 902-7	Under the Material column in the fifth row change the "FA3" to read "3FA".
752	Table 902-8	Under the Material column in the fourth row change the "FA2" to read "2FA".
752	Table 902-8	Under the Material column in the fifth row change the "FA3" to read "3FA".
761	Table 904-2	Delete the footnote f and any other reference to footnote f from the table.
767	905.03	Change the first sentence of the first paragraph to read: "Deformed bars, must meet the requirements of ASTM A 706, ASTM A 615, or ASTM A 996 (Type R or Type A only) for Grade 60 steel bars, unless otherwise required".
767*	905.03	Change the first sentence of the second paragraph to read: "Unless otherwise specified, spiral reinforcement must meet the requirements of plain or deformed Grade 40 steel bars of ASTM A 615, ASTM A 996 (Type A), or the requirements of cold-drawn wire of ASTM A 1064".
767	905.03	Change the first sentence of the third paragraph to read: "Bar reinforcement for prestressed concrete beams must meet the requirements of ASTM A 996 (Type R) for Grade 60 steel bars, except the Engineer will allow bar reinforcement that meets the requirements of ASTM A 615 or ASTM A 996 (Type A) for Grade 40 steel bars for stirrups in prestressed concrete beams".
768	905.03.C	Change the first sentence in the subsection to read: "Epoxy coated steel reinforcement, if required, must be coated in accordance with ASTM A 775, with the following exceptions and additions."
768	905.03.C.3	Change the first sentence of this subsection to read: "Include written certification that the coated reinforcing bars were cleaned, coated, and tested in accordance with ASTM A 775 with the coating applicator."
768	905.05	Change the first sentence of the first paragraph to read: "Deformed steel bars must meet the requirements of ASTM A 706 or the requirements for Grade 40, Grade 50, or Grade 60 of ASTM A 615 or ASTM A 996 (Type R or Type A only)".
768	905.06	Delete this subsection in its entirety and replace it with the following: "Deformed wire fabric for prestressed concrete and fabric for concrete pavement reinforcement must meet the requirements of ASTM A 1064 and fabricated as required."
772	906.07	Change the first paragraph to read:

Page	Subsection	Errata
		<p>"High-strength bolt fasteners for structural joints must meet the requirements of ASTM A 325 Type 1 bolts. High-strength nuts for structural joints must meet the requirements of ASTM A 563 Grade DH or AASHTO M 292 Grade 2H. High-strength washers for structural joints must meet the requirements of ASTM F 436 Type 1 for circular, beveled, clipped circular, and clipped beveled washers."</p> <p>Change the second sentence of the second paragraph of this subsection to read: "Galvanized nuts must be tapped oversize in accordance with ASTM A 563 and meet Supplementary Requirements S1, Lubricant and Rotational Capacity Test for Coated Nuts and S2, Lubricant Dye."</p>
772	906.08	Change the last sentence of the first paragraph to read "Washers must be made from austenitic stainless steel ASTM A 276 UNS designation S31600 or S31603."
777*	907.03.D.2.a	Change the first sentence of the second paragraph to read: "Angle sections must be nominal 2½ inch by 2½ inch by ¼ inch."
777*	907.03.D.2.b	Change the first sentence of the first paragraph to read: "Angle section braces must be nominal 1¾ inch by 1¾ inch by ¼ inch or nominal 2 inch by 2 inch 3/16 inch."
782	908.04	Change the first sentence of the first paragraph of this subsection to read: "Steel castings for steel construction must meet the requirements of ASTM A 148 for Grade 60/90 carbon steel castings, as shown on the plans, unless the Engineer approves an alternate in writing."
783*	908.09.A	Change the title of this subsection and the first sentence to read "A. Base Plates, Angle, and Non-Tubular Post Elements. Galvanized base plates, angle, rail splice elements, and non-tubular post elements must meet the requirements of ASTM A 36 and ASTM A 123".
783*	908.09.B	Change the title of this subsection and the first sentence to read "B. Rail Elements and Tubular Post Elements. Rail elements and tubular post elements must meet the requirements of ASTM A 500, for Grade B and subsection 908.09.B and be galvanized in accordance with ASTM A 123".
784	908.09.C	Change the second sentence to read: "Heavy hex nuts must meet the requirements of ASTM A 563." Change the third sentence to read: "Bolts, used as rail fasteners, washers and nuts must meet the requirements of ASTM A 325, Type 1." Change the sixth sentence to read:

Page	Subsection	Errata
		"All flat washers must meet the requirements of ASTM F 436." Add the following sentence to the end of the subsection: "Bolts, nuts, washers and other hardware must be hot-dip galvanized in accordance with AASHTO M 232."
785	908.11.B	Change the second paragraph to read: "Bolts, nuts, and round washers for guardrail, other than at bridge barrier railings, must meet the requirements of ASTM A 307, ASTM A 563 (Grade A with Supplementary Requirements S1 of ASTM A 563), and ASTM F 436, respectively." Change the third paragraph to read: "Washers, other than round washers, for guardrail must meet the requirements for circular washers in ASTM F 436 except that the dimensions must be as shown on the plans." Change the fifth paragraph to read: "Bolts, nuts, and washers for connections at bridge barrier railings must conform to ASTM A 325 Type 1 galvanized high-strength structural bolts with suitable nuts and hardened washers."
787	908.14.B	Add the following sentence to the end of the third paragraph of this subsection: "Exposed threaded ends of anchor bolts must be galvanized a minimum of 20 inches." Change the sixth paragraph in this subsection to read: "Provide washers meeting the requirements of ASTM F 436 for circular washers."
787	908.14.B	Change the second sentence of the fourth paragraph to read "After coating, the maximum limit of pitch and major diameter for bolts with a diameter no greater than 1 inch may exceed the Class 2A limit by no greater than 0.021 inch, and by no greater than 0.031 inch for bolts greater than 1 inch in diameter".
787*	908.14.C	Change the first paragraph to read "Provide either four or six high strength anchor bolts per the contract plans, meeting the mechanical requirements of ASTM F 1554, for Grade 105, with each standard. Anchor bolts for traffic signal strain poles must meet the requirements of subsection 908.14.B with the following exceptions and additions:"
789	909.03	Change the second sentence of the second paragraph to read: "As an alternative to the AASHTO M 36 requirements for metal pipe, the Contractor may use gasket material meeting the low temperature flexibility and elevated temperature flow test requirements of ASTM C 990, excluding the requirements for softening point, flashpoint and fire point."

Page	Subsection	Errata
793	909.06	Change the first sentence of the second paragraph of this subsection to read: "Provide Corrugated Polyvinyl Chloride Pipe (CPV) and required fittings meeting the requirements of AASHTO M 304."
793*	909.05.D	Change the second sentence of the paragraph to read "Provide a continuous welded joint to create a watertight casing that is capable of withstanding handling and installation stresses. Perform field welding by the SMAW process using E7018 electrodes."
794*	909.08.A	Change the first sentence to read: "Provide bridge deck downspouts of PE pipe meeting the requirements of ASTM F 714, PE 4710, DR 26."
804	Table 909-9	In the note area at the bottom of the table change the designation of the second note from "c." to "b."
811	910.04	Add the following sentence to the end of this subsection: "Fabricate silt fence according to subsection 916.02."
829*	912.08.K	Replace Table 912-10 with the Table 912-10 below.
833*	913.03.B	Change the first sentence of the first paragraph to read: "Clay brick, to construct manholes, catch basins, and similar structures, must meet the requirements of ASTM C 32, for Grade MS."
837*	914.04	Add the following as subsection 914.04.C: "C. Lubricant-Adhesive for Neoprene Joint Seals. The lubricant-adhesive must be a single-component moisture-curing polyurethane and aromatic hydrocarbon solvent mixture meeting ASTM D 2835, Type I. Ship in containers plainly marked with the lot or batch number of the material and date of manufacture. Store at temperatures between 58 and 80°F. Do not exceed 12 months shelf-life prior to use."
840	914.08	Change the first sentence of the second paragraph to read: "Straight tie bars for end-of-pour joints must consist of bars of the diameter and length shown on the plans meeting the requirements of ASTM A 615, ASTM A 706, or ASTM A 996 (Type R or Type A only)".
840*	914.09.A	Change the first sentence of the first paragraph to read: "Straight tie bars for longitudinal pavement joints must consist of bars of the diameter and length shown on the plans meeting the requirements of ASTM A 615, ASTM A 706, or ASTM A 996 (Type R or Type A only)".
840	914.09.B	Change the first sentence of the first paragraph to read: "Bent tie bars for bulkhead joints must consist of bars of the diameter and length shown on the plans."
841	914.12	In the first sentence of this subsection change "AASHTO Division II" to read "AASHTO LRFD Bridge Construction Specifications".

Page	Subsection	Errata
841*	914.13	In the first sentence of this subsection change "ASTM D 1248, for Type III, Class B" to read "ASTM D 4976, Group 2, Class 4, Grade 4".
844	916.01.A	Change the first sentence to read: "Cobblestone must consist of rounded or semi-rounded rock fragments with an average dimension from 3 inches to 10 inches."
845	916.01.D.1	Change the second sentence to read: "Checkdams for ditch grades 2 percent or greater must be constructed using cobblestone or broken concrete ranging from 3 inches to 10 inches in size."
851*	917.10.B.1	Delete the paragraph and replace it with the following: "1. Class A. Provide and apply Class A chemical nutrient fertilizer either according to MSU Soil Testing Lab Recommendations for Phosphorus Applications to Turfgrass, except the maximum single application rate of nutrient will be 48 pounds per acre, when soil tests are required or as indicated in subsections 917.10.B.1.a and 917.10.B.1.b."
851	917.10.B.1	Add the MSU Soil Testing Lab Recommendations for Phosphorus Applications to Turfgrass, found below, after the first paragraph of this subsection.
853	917.15.B.1	Change the second sentence of the subsection to read: "The net must meet the requirements of subsection 917.15.D and be capable of reinforcing the blanket to prevent damage during shipping, handling, and installation."
857	918.01	Add the following two paragraphs following the first paragraph of this subsection: "Wall thickness and outside diameter dimensions must conform to ASTM D 1785 for smooth-wall schedule 40 and 80 PVC conduit material. The Department will allow no more than 3 percent deviation from the minimum wall thickness specified. Wall thickness range must be within 12 percent in accordance with ASTM D 3035 for smooth-wall coilable schedule 40 and 80 PE conduit."
858	918.01.E	Delete the first three sentences of the second paragraph shown on page 858.
863	918.06.F.1	Delete the third paragraph in this subsection in its entirety and replace it with the following: "Provide smooth or deformed welded wire fabric in accordance with ASTM A 1064."
864	918.07.C	Change the first sentence of the first paragraph to read: "Provide anchor bolts, nuts, and washers meeting the requirements of subsection 908.14.A and subsection 908.14.B."

Page	Subsection	Errata
864	918.07.C	Delete the second sentence of the second paragraph.
864	918.07.C	Change the third sentence to read: "Provide anchor bolts threaded 4 inches beyond the anchor bolt projection shown on the plans."
867	918.08.C	Change the last sentence of the first paragraph on this page to read: "Galvanize bolts, nuts, washers, and lock washers as specified in subsection 908.14.B."
867	918.08.C	Change the last sentence of the subsection to read: "Provide each frangible base with manufacturer access covers as shown on the plans."
867*	918.08.D	Delete this subsection in its entirety and replace with the following: "Provide galvanized anchor bolts, studs, nuts, couplings, and washers in accordance with subsection 908.14."
879	918.10.J	Change the third sentence of the second paragraph of this subsection to read: "Provide anchor bolts and associated nuts, washers, and hardware meeting the requirements of subsection 908.14."
887	919.06	Change the second paragraph to read: "Shims must be fabricated from brass shim stock or brass strip meeting the requirements of ASTM B 36, for copper alloy UNS No. C26000, half-hard rolled temper, or fabricated from galvanized sheeting meeting the requirements of ASTM A 653, for Coating Designation G 90."
903	921.03.D	Delete the last three sentences of the first paragraph of this subsection.
914	921.05.D	Change the first sentence of this subsection to read: "Provide anchor bolts meeting the requirements of subsection 908.14.C, including elongation and reduction of area requirements."
916	921.07	Change the first sentence of the first paragraph to read: "Provide LED case signs internally illuminated by LEDs and changeable message case signs internally illuminated with LED light sources."
936	922.04.B	In the first sentence of the first paragraph change the "R-52" to "R-126".
936	922.04.B	Add the following to the end of the first paragraph: "Hardware used to connect the end section to the barrier must meet the requirements of NCHRP 350 or MASH (Test Level 3 or higher)."
936	922.04.B	In the first sentence of the second paragraph delete "R-52".
953*	Pay Item Index	Delete the following pay item reading: "DB Cable, in Conduit, 600 Volt, (number) 1/C# (size)678 819"

Page	Subsection	Errata		
957	Pay Item Index	Delete the following pay item from the list: Guardrail Buffered End	560	807
960	Pay Item Index	Change the following pay item to read: "Mobilization, Max (dollar)	107	150"
961	Pay item Index	Delete the following pay items from the list: Pavt Mrkg, (material), 4 inch, SRSM, (color)..... Pavt Mrkg, (material), 4 inch, SRSM, 2 nd Application, (color).....	598..... 598.....	811 811
961	Pay Item Index	Change the following pay items in the list to read: Pavt Mrkg, Ovly Cold Plastic, 12 inch, Cross Hatching, (color) Pavt Mrkg, Polyurea, __ inch, Cross Hatching, (color) Add the following pay items to the list: "Pavt Mrkg, Polyurea, (legend)..... Pavt Mrkg, Polyurea, (symbol)..... Pedestal, Pushbutton, Alum..... Pedestal, Pushbutton, Rem.....	598..... 598..... 696..... 696.....	811 811 820 820"
962	Pay Item Index	Change the following pay items in the list to read: "Pile Driving Equipment, Furn (Structure No.) Pile, Galv (Structure No.)"		
963	Pay Item Index	Change the following pay item to read: "Rem Curing Compound, for Longit Mrkg, __ inch	598	811"
964	Pay Item Index	Change the following pay item to read: "Sewer, CI __, __ inch, Jacked in Place	200	402"
		"Sign Cover, Type I	622	812"
965*	Pay Item Index	Change the following pay item in the list to read: "Steel Casing Pipe, __ inch, Tr Det __ Site Preparation, Max (dollar)	646	815"
966	Pay Item Index	Delete the following pay item form the list; Temp Casing.....	533.....	718
967*	Pay Item Index	Delete the following pay item from the list; Truss Fdn Anchor Bolts, Replace.....	584.....	810
967	Pay Item Index	Change the following pay item in the list to read: "Traf Regulator Control"		
968*	Pay item Index	Change the following pay item in the list to read: "Water Shutoff, Adj, Temp, Case __ Watering and Cultivating, First Season, Min (dollar)..... Watering and Cultivating, Second Season, Min (dollar)	646 646	815 815"

Page	Subsection	Errata
969	Pay item Index	Change the following pay item in the list to read: "Witness, Log, Layout, \$1000.00"
993	General Index	Change "Shop Plans (see Plans and Working Drawings)" to read "Shop Drawings (see Plans and Working Drawings)".

**Table 701-1
Concrete Structure Mixtures**

Concrete Grade (e,h)	Section Number Reference (i)	Cement Content per cyd (b,c)		Type A, D or no Admixture	Type MR, F, or G Admixtures (g)			Minimum Strength of Concrete (f)					
		lb	sack		Before Admixture	After Admixture (Type MR)	After Admixture (Type F or G)	Flexural (psi)			Compressive (psi)		
								7 Day	14 Day	28 Day (Class Design Strength)	7 Day	14 Day	28 Day (Class Design Strength)
D (a)	706, 711, 712	658 (d)	7.0	0 - 3	0 - 3	0 - 6	0 - 7	625	700	725	3,200	4,000	4,500
S1	705	611	6.5	3 - 5	0 - 3	3 - 6	3 - 7	600	650	700	3,000	3,500	4,000
T	705, 706	611	6.5	3 - 7	0 - 4	3 - 7	3 - 8	550	600	650	2,600	3,000	3,500
S2 (a)	401, 705, 706, 712, 713, 801, 802, 803, 810	564	6.0	0 - 3	0 - 3	0 - 6	0 - 7	550	600	650	2,600	3,000	3,500
		526 (d)	5.6										
S3	402, 403, 803, 804, 806	517	5.5	0 - 3	0 - 3	0 - 6	0 - 7	500	550	600	2,200	2,600	3,000
		489 (d)	5.2										

a. Unless otherwise required, use Coarse Aggregate 6AA or 17A for exposed structural concrete in bridges, retaining walls, and pump stations.

b. Do not place concrete mixtures containing supplemental cementitious materials unless the local average minimum temperature for the next 10 consecutive days is forecast to be above 40 °F. Adjustments to the time required for opening to construction or vehicular traffic may be necessary. Cold weather protection may be required, as described in the quality control plan. The restriction does not apply to Grade S1 concrete in foundation piling below ground level or Grade T concrete in tremie construction.

c. Type III cement is not permitted

d. Use admixture quantities specified by the Qualified Products Lists to reduce mixing water. Admixture use is required for Grade D, Grade S2, and Grade S3, concrete with a reduced cement content. Use a water-reducing retarding admixture at the required dosage for Grade D concrete to provide the setting retardation required. When the maximum air temperature is not forecast to exceed 60 °F for the day, the Contractor may use a water-reducing admixture or a water-reducing retarding admixture. Ensure Grade D concrete in concrete diaphragms contains a water-reducing admixture, or a water-reducing retarding admixture. For night casting, the Contractor may use a water-reducing admixture in lieu of water-reducing retarding admixture, provided that the concrete can be placed and finished prior to initial set.

e. The mix design basis for bulk volume (dry, loose) of coarse aggregate per unit volume of concrete is 68% for Grade S1, and 70% for Grade D, Grade S2, Grade T, and Grade S3.

f. The Contractor may use flexural strength to determine form removal. Use compressive strength for acceptance in other situations.

g. MR = Mid-range.

h. The Engineer will allow the use of an optimized aggregate gradation as specified in section 604.

i. Section Number Reference:

401	Culverts	711	Bridge Railings	803	Concrete Sidewalk, Sidewalk Ramps, and Steps
402	Storm Sewers	712	Bridge Rehabilitation-Concrete	804	Concrete Barriers and Glare Screens
403	Drainage Structures	713	Bridge Rehabilitation-Steel	806	Bicycle Paths
705	Foundation Piling	801	Concrete Driveways	810	Permanent Traffic Signs and Supports
706	Structural Concrete Construction	802	Concrete Curb, Gutter and Dividers		

An asterisk (*) indicates an entry which has been revised from an earlier version of this Supplemental Specification.

**Table 902-6
Superpave Final Aggregate Blend Physical Requirements**

Est. Traffic (million ESAL)	Mix Type	Percent Crushed Minimum Criteria		Fine Aggregate Angularity Minimum Criteria		% Sand Equivalent Minimum Criteria		Los Angeles Abrasion % Loss Maximum Criteria		% Soft Particles Maximum Criteria (b)		% Flat and Elongated Particles Maximum Criteria (c)	
		Top & Leveling Courses	Base Course	Top & Leveling Courses	Base Course	Top & Leveling Courses	Base Course	Top & Leveling Courses	Base Course	Top & Leveling Courses	Base Course	Top & Leveling Courses	Base Course
< 0.3	LVSP	55/—	—	—	—	40	40	45	45	10	10	—	—
< 0.3	E03	55/—	—	—	—	40	40	45	45	10	10	—	—
≥0.3 - <1.0	E1	65/—	—	40	—	40	40	40	45	10	10	—	—
≥1.0 - < 3	E3	75/—	50/—	40(a)	40(a)	40	40	35	40	5	5	10	10
≥3 - <10	E10	85/80	60/—	45	40	45	45	35	40	5	5	10	10
≥10 - <30	E30	95/90	80/75	45	40	45	45	35	35	3	4.5	10	10
≥30 - <100	E50	100/10 0	95/90	45	45	50	50	35	35	3	4.5	10	10

- (a) For an E3 mixture type that enters the restricted zone as defined in Table 902-5, the minimum is 43. If these criteria are satisfied, acceptance criteria and associated incentive/disincentive or pay adjustment tied to this gradation restricted zone requirement included in contract, do not apply. Otherwise, final gradation blend must be outside of the restricted zone.
- (b) Soft particles maximum is the sum of the shale, siltstone, ochre, coal, clay-ironstone and particles that are structurally weak or are non-durable in service.
- (c) Maximum by weight with a 1 to 5 aspect ratio.

Note: "85/80" denotes that 85 percent of the coarse aggregate has one fractured face and 80 percent has at least two fractured faces.

Table 912-10 Minimum Retention Requirements				
Preservative	Minimum Retention, (pcf)			AWPA Standard
	Guardrail Posts	Sign Posts	Blocks	
Pentachlorophenol	0.60	0.50	0.40	A6
CCA, ACZA	0.60	0.50	0.40	A11
ACQ (a)	0.60	Not Allowed	0.40	A11
CA-B (a)	0.31	Not Allowed	0.21	A11
CA-A (a)	0.31	Not Allowed	0.15	A11
Other Waterborne preservatives	AWPA Commodity Specification A, Table 3.0, Use Category 4B	Not Allowed	AWPA Commodity Specification A, Table 3.0, Use Category 4A	A11
a. Non-Metallic washers or spacers are required for timber and lumber treated with ACQ or CA placed in direct contact with aluminum. Do not use with sign posts.				

MSU Soil Testing Lab Recommendations for Phosphorus Applications to Turfgrass
3/8/2012

		Sand based rootzone establishment	Golf greens and tees est. or mature; Kentucky bluegrass or perennial ryegrass athletic fields est. or mature; sand based rootzone mature	Lawns, golf course fairways; establishment or mature	Establishment without soil test
Bray P1, Mehlich 3 Soil Test Value (ppm): pH<7.4	Olsen Soil Test Value (ppm) pH>7.4	Recommendation (lbs. P ₂ O ₅ /1000 ft. ²)	Recommendation (lbs. P ₂ O ₅ /1000 ft. ²)	Recommendation (lbs. P ₂ O ₅ /1000 ft. ²)	Recommendation (lbs. P ₂ O ₅ /1000 ft. ²)
0	0	4.4	3.4	2.5	2.5 lbs. year (Maximum single application of 1.5 lbs.)
2	1.3	4.1	3.1	2.2	
4	2.7	3.9	2.7	1.9	
6	4	3.6	2.4	1.6	
8	5.3	3.4	2.0	1.3	
10	6.7	3.1	1.7	1.0	
12	8	2.8	1.4	0.7	
14	9.3	2.6	1.0	0.4	
16	10.7	2.3	0.7	0.1	
18	12	2.1	0.3	0.0	
20	13.3	1.8	0.0		
22	14.7	1.5			
24	16	1.3			
26	17.3	1.0			
28	18.7	0.8			
30	20	0.5			
32	21.3	0.2			
34	22.7	0.0			

Web resources: www.turf.msu.edu or www.bephosphorusmart.msu.edu

CITY OF ANN ARBOR LIVING WAGE ORDINANCE

RATE EFFECTIVE APRIL 30, 2015 - ENDING APRIL 29, 2016

\$12.81 per hour

If the employer provides health care benefits*

\$14.30 per hour

If the employer does **NOT** provide health care benefits*

Employers providing services to or for the City of Ann Arbor or recipients of grants or financial assistance from the City of Ann Arbor for a value of more than \$10,000 in a twelve-month period of time must pay those employees performing work on a City of Ann Arbor contract or grant, the above living wage.

ENFORCEMENT

The City of Ann Arbor may recover back wages either administratively or through court action for the employees that have been underpaid in violation of the law. Persons denied payment of the living wage have the right to bring a civil action for damages in addition to any action taken by the City.

Violation of this Ordinance is punishable by fines of not more than \$500/violation plus costs, with each day being considered a separate violation. Additionally, the City of Ann Arbor has the right to modify, terminate, cancel or suspend a contract in the event of a violation of the Ordinance.

* Health Care benefits include those paid for by the employer or making an employer contribution toward the purchase of health care. The employee contribution must not exceed \$.50 an hour for an average work week; and the employer cost or contribution must equal no less than \$1/hr for the average work week.

The Law Requires Employers to Display This Poster Where Employees Can Readily See It.

**For Additional Information or to File a Complaint Contact:
Mark Berryman at 734/794-6500 or mberryman@a2gov.org**



Vendor Conflict of Interest Disclosure Form

All vendors interested in conducting business with the City of Ann Arbor must complete and return the Vendor Conflict of Interest Disclosure Form in order to be eligible to be awarded a contract. Please note that all vendors are subject to comply with the City of Ann Arbor's conflict interest policies as stated within the certification section below.

If a vendor has a relationship with a City of Ann Arbor official or employee, an immediate family member of a City of Ann Arbor official or employee, the vendor shall disclose the information required below.

Certification: I hereby certify that to my knowledge, there is no conflict of interest involving the vendor named below:

- 1. No City official or employee or City employee's immediate family member has an ownership interest in vendor's company or is deriving personal financial gain from this contract.
2. No retired or separated City official or employee who has been retired or separated from the City for less than one (1) year has an ownership interest in vendor's Company.
3. No City employee is contemporaneously employed or prospectively to be employed with the vendor.
4. Vendor hereby declares it has not and will not provide gifts or hospitality of any dollar value or any other gratuities to any City employee or elected official to obtain or maintain a contract.
5. Please note any exceptions below:

Table with 2 columns: Vendor Name, Vendor Phone Number. Includes a section for Conflict of Interest Disclosure with checkboxes for Relationship to employee, Interest in vendor's company, and Other.

*Disclosing a potential conflict of interest does not disqualify vendors. In the event vendors do not disclose potential conflicts of interest and they are detected by the City, vendor will be exempt from doing business with the City.

I certify that the information provided is true and correct by my signature below:

Signature of Vendor Authorized Representative, Date, Printed Name of Vendor Authorized Representative

PROCUREMENT USE ONLY

- Yes, named employee was involved in Bid / Proposal process.
No, named employee was not involved in procurement process or decision.

CITY OF ANN ARBOR NON-DISCRIMINATION ORDINANCE

Relevant provisions of Chapter 112, Nondiscrimination, of the Ann Arbor City Code are included below. You can review the entire ordinance at www.a2gov.org/departments/city-clerk

Intent: It is the intent of the city that no individual be denied equal protection of the laws; nor shall any individual be denied the enjoyment of his or her civil or political rights or be discriminated against because of actual or perceived age, arrest record, color, disability, educational association, familial status, family responsibilities, gender expression, gender identity, genetic information, height, HIV status, marital status, national origin, political beliefs, race, religion, sex, sexual orientation, source of income, veteran status, victim of domestic violence or stalking, or weight.

Discriminatory Employment Practices: No person shall discriminate in the hire, employment, compensation, work classifications, conditions or terms, promotion or demotion, or termination of employment of any individual. No person shall discriminate in limiting membership, conditions of membership or termination of membership in any labor union or apprenticeship program.

Discriminatory Effects: No person shall adopt, enforce or employ any policy or requirement which has the effect of creating unequal opportunities according to actual or perceived age, arrest record, color, disability, educational association, familial status, family responsibilities, gender expression, gender identity, genetic information, height, HIV status, marital status, national origin, political beliefs, race, religion, sex, sexual orientation, source of income, veteran status, victim of domestic violence or stalking, or weight for an individual to obtain housing, employment or public accommodation, except for a bona fide business necessity. Such a necessity does not arise due to a mere inconvenience or because of suspected objection to such a person by neighbors, customers or other persons.

Nondiscrimination by City Contractors: All contractors proposing to do business with the City of Ann Arbor shall satisfy the contract compliance administrative policy adopted by the City Administrator in accordance with the guidelines of this section. All city contractors shall ensure that applicants are employed and that employees are treated during employment in a manner which provides equal employment opportunity and tends to eliminate inequality based upon any classification protected by this chapter. All contractors shall agree not to discriminate against an employee or applicant for employment with respect to hire, tenure, terms, conditions, or privileges of employment, or a matter directly or indirectly related to employment, because of any applicable protected classification. All contractors shall be required to post a copy of Ann Arbor's Non-Discrimination Ordinance at all work locations where its employees provide services under a contract with the city.

Complaint Procedure: If any individual has a grievance alleging a violation of this chapter, he/she has 180 calendar days from the date of the individual's knowledge of the allegedly discriminatory action or 180 calendar days from the date when the individual should have known of the alleged discriminatory action to file a complaint with the city's Human Rights Commission. If an individual fails to file a complaint alleging a violation of this chapter within the specified time frame, the complaint will not be considered by the Human Rights Commission. The complaint should be made in writing to the Human Rights Commission. The complaint may be filed in person with the City Clerk, by e-mail at aahumanrightscommission@gmail.com, or by mail (Ann Arbor Human Rights Commission, PO Box 8647, Ann Arbor, MI 48107). The complaint must contain information about the alleged discrimination, such as name, address, phone number of the complainant and location, date and description of the alleged violation of this chapter.

Private Actions For Damages or Injunctive Relief: To the extent allowed by law, an individual who is the victim of discriminatory action in violation of this chapter may bring a civil action for appropriate injunctive relief or damages or both against the person(s) who acted in violation of this chapter.

THIS IS AN OFFICIAL GOVERNMENT NOTICE AND
MUST BE DISPLAYED WHERE EMPLOYEES CAN READILY SEE IT.