

CITY OF ANN ARBOR
INVITATION TO BID



WWTP Clear Well Improvements

ITB No. 4680

Due Date: Tuesday, June 1, 2021 at 2:00PM (Local Time)

Public Services Area / Wastewater Treatment Services Unit

Issued By:

City of Ann Arbor
Procurement Unit
301 E. Huron Street
Ann Arbor, MI 48104

TABLE OF CONTENTS

TABLE OF CONTENTS.....	TC-1
NOTICE OF PRE-BID CONFERENCE.....	NP-1
INSTRUCTIONS TO BIDDERS.....	IB-1 to 6
INVITATION TO BID.....	ITB-6 to 3
BID FORMS.....	BF-1 to 5
CONTRACT.....	C-6 to 4
BOND FORMS.....	B-1 to 2
GENERAL CONDITIONS.....	GC-1 to 18
STANDARD SPECIFICATIONS.....	SS-1

DETAILED SPECIFICATIONS

DIVISION 1 - GENERAL REQUIREMENTS

01 10 00	SUMMARY	1-6
01 22 00	UNIT PRICES	1-4
01 23 00	ALTERNATES	1-1
01 25 00	SUBSTITUTION PROCEDURES	1-3
01 26 00	CONTRACT MODIFICATION PROCEDURES	1-2
01 29 00	PAYMENT PROCEDURES	1-3
01 31 00	PROJECT MANAGEMENT AND COORDINATION	1-6
01 32 00	CONSTRUCTION PROGRESS DOCUMENTATION	1-5
01 32 33	PHOTOGRAPHIC DOCUMENTATION	1-2
01 33 00	SUBMITTAL PROCEDURES	1-7
01 40 00	QUALITY REQUIREMENTS	1-6
01 42 00	REFERENCES	1-7
01 50 00	TEMPORARY FACILITIES AND CONTROLS	1-6
01 60 00	PRODUCT REQUIREMENTS	1-4
01 73 00	EXECUTION	1-7
01 77 00	CLOSEOUT PROCEDURES	1-5
01 78 23	OPERATION AND MAINTENANCE DATA	1-5
01 78 39	PROJECT RECORD DOCUMENTS	1-3
01 79 00	DEMONSTRATION AND TRAINING	1-3

DIVISION 2 – EXISTING CONDITIONS

02 01 10	CONCRETE RESERVOIR MAINTENANCE	1-3
02 41 19	SELECTIVE DEMOLITION	1-6

DIVISION 3 - CONCRETE

03 01 30	MAINTENANCE OF CAST-IN-PLACE CONCRETE	1-5
03 15 00	CONCRETE ACCESSORIES	1-5
03 30 00	CAST-IN-PLACE CONCRETE	1-7

DIVISION 4 – MASONRY – (NOT USED)

DIVISION 5 - METALS
05 50 00 METAL FABRICATIONS 1-4

DIVISIONS 6 – 8 – (NOT USED)

DIVISION 9 - FINISHES
09 92 00 FACILITY PAINTING 1-7

DIVISION 10 – 26 (NOT USED)

DIVISION 26 – ELECTRICAL (REFER TO DRAWINGS)

DIVISION 31 – EARTHWORK – (NOT USED)

DIVISION 32 – EXTERIOR IMPROVEMENTS
32 92 00 TURF AND GRASSES 1-9

DIVISION 33 - UTILITIES – (NOT USED)

DIVISION 40 – PROCESS INTEGRATION
40 05 07 HANGERS AND SUPPORTS FOR PROCESS PIPING 1-7
40 05 51 COMMON REQUIREMENTS FOR PROCESS VALVES 1-6
40 05 67.39 PRESSURE-RELIEF VALVES 1-4
40 75 43 DISSOLVED OXYGEN ANALYZERS 1-3

DIVISION 43 – PROCESS EQUIPMENT (NOT USED)

DIVISION 46 – WATER AND WASTEWATER EQUIPMENT
46 51 46 MEMBRANE DIFFUSERS 1-8

APPENDIX A – GEOTECHNICAL REPORT APDX-1-47

ATTACHMENTS

City of Ann Arbor Prevailing Wage Declaration Form
City of Ann Arbor Living Wage Forms
City of Ann Arbor Vendor Conflict of Interest Disclosure Form
City of Ann Arbor Non-Discrimination Ordinance Declaration Form and Notice

NOTICE OF PRE-BID CONFERENCE

A pre-proposal meeting will be held:

When: **May 4, 2021** at 10:00 a.m. (local time)

Where: Virtual meeting via Microsoft Teams – pre-registration via e-mail to CEnglert@a2gov.org is required to attend.

Attendance at this conference is highly recommended. Administrative and technical questions regarding this project will be answered at this time. The pre-bid conference is for information only. Any answers furnished will not be official until verified in writing by the Financial Service Area, Procurement Unit. Answers that change or substantially clarify the bid will be affirmed in an addendum.

A site visit is planned for May 6, 2021. Only 6 bidding personnel will be allowed on-site at a time. Available time slots are:

10:00 AM – 11:00 AM

11:00 AM – 12:00 PM

12:00 PM – 1:00 PM

1:00 PM – 2:00 PM

2:00 PM – 3:00 PM

3:00 PM – 4:00 PM

Bidders are encouraged to reserve a time slot by contacting:

Chris Englert – cenglert@a2gov.org

Additional site visit dates/times will be added as needed.

INSTRUCTIONS TO BIDDERS

General

Work to be done under this Contract is generally described through the detailed specifications and must be completed fully in accordance with the contract documents. All work to be done under this Contract is located at the City of Ann Arbor Wastewater Treatment Plant.

Any Bid which does not conform fully to these instructions may be rejected.

Preparation of Bids

Bids should be prepared providing a straight-forward, concise description of the Bidder's ability to meet the requirements of the ITB. Bids shall be written in ink or typewritten. No erasures are permitted. Mistakes may be crossed out and corrected and must be initialed and dated in ink by the person signing the Bid.

Bids must be submitted on the "Bid Forms" provided with each blank properly filled in. If forms are not fully completed it may disqualify the bid. No alternative bid will be considered unless alternative bids are specifically requested. If alternatives are requested, any deviation from the specification must be fully described, in detail on the "Alternate" section of Bid form.

Each person signing the Bid certifies that he/she is the person in the Bidder's firm/organization responsible for the decision as to the fees being offered in the Bid and has not and will not participated in any action contrary to the terms of this provision.

Questions or Clarifications / Designated City Contacts

All questions regarding this ITB shall be submitted via email. Emailed questions and inquires will be accepted from any and all prospective Bidders in accordance with the terms and conditions of the ITB.

All questions shall be due on or before May 10, 2021 at 2:00 PM (local time) and should be addressed as follows:

Specification/Scope of Work questions emailed to CEnglert@a2gov.org.
Bid Process and Compliance questions emailed to cspencer@a2gov.org

Any error, omissions or discrepancies in the specification discovered by a prospective contractor and/or service provider shall be brought to the attention of Christopher Englert, P.E., Wastewater Treatment Services Engineer at CEnglert@a2gov.org after discovery as possible. Further, the contractor and/or service provide shall not be allowed to take advantage of errors, omissions or discrepancies in the specifications.

Addenda

If it becomes necessary to revise any part of the ITB, notice of the Addendum will be posted to Michigan Inter-governmental Trade Network (MITN) www.mitn.info and/or City of Ann Arbor web site www.A2gov.org for all parties to download.

Each Bidder must in its Bid, to avoid any miscommunications, acknowledge all addenda which it has received, but the failure of a Bidder to receive, or acknowledge receipt of; any addenda shall

not relieve the Bidder of the responsibility for complying with the terms thereof.

The City will not be bound by oral responses to inquiries or written responses other than written addenda.

Bid Submission

All Bids are due and must be delivered to the City of Ann Arbor Procurement Unit on or before June 1, 2021 at 2:00 PM (local time). Bids submitted late or via oral, telephonic, telegraphic, electronic mail or facsimile **will not** be considered or accepted.

Each Bidder must submit one (1) original Bid and two (2) Bid copies in a sealed envelope clearly marked: **ITB No. 4680 WWTP Clear Well Improvements.**

Bids must be addressed and delivered to:

City of Ann Arbor
Procurement Unit,
c/o Customer Services, 1st Floor
301 East Huron Street
Ann Arbor, MI 48104

All Bids received on or before the Due Date will be publicly opened and recorded immediately. No immediate decisions are rendered.

The following forms provided within this ITB Document must be included in submitted bids.

- **City of Ann Arbor Prevailing Wage Declaration of Compliance**
- **City of Ann Arbor Living Wage Ordinance Declaration of Compliance**
- **Vendor Conflict of Interest Disclosure Form**
- **City of Ann Arbor Non-Discrimination Ordinance Declaration of Compliance**

Bids that fail to provide these forms listed above upon bid opening will be rejected as non-responsive and will not be considered for award.

Hand delivered bids may be dropped off in the Purchasing drop box located in the Ann Street (north) vestibule of City Hall which is accessible to the public at all hours. The City will not be liable to any Bidder for any unforeseen circumstances, delivery or postal delays. Postmarking to the Due Date will not substitute for receipt of the Bid. Each Bidder is responsible for submission of their Bid.

Additional time for submission of bids past the stated due date and time will not be granted to a single Bidder; however, additional time may be granted to all Bidders when the City determines in its sole discretion that circumstances warrant it.

Award

The City intends to award a Contract(s) to the lowest responsible Bidder(s). On multi-divisional contracts, separate divisions may be awarded to separate Bidders. The City may also utilize alternatives offered in the Bid Forms, if any, to determine the lowest responsible Bidder on each division, and award multiple divisions to a single Bidder, so that the lowest total cost is achieved for the City. For unit price bids, the Contract will be awarded based upon the unit prices and the

lump sum prices stated by the bidder for the work items specified in the bid documents, with consideration given to any alternates selected by the City. If the City determines that the unit price for any item is materially different for the work item bid than either other bidders or the general market, the City, in its sole discretion, in addition to any other right it may have, may reject the bid as not responsible or non-conforming.

The acceptability of major subcontractors will be considered in determining if a Bidder is responsible. In comparing Bids, the City will give consideration to alternate Bids for items listed in the bid forms. All key staff and subcontractors are subject to the approval by the City.

Official Documents

The City of Ann Arbor officially distributes bid documents from the Procurement Unit or through the Michigan Intergovernmental Trade Network (MITN). Copies of the bid documents obtained from any other source are not Official copies. Addenda and other bid information will only be posted to these official distribution sites. If you obtained City of Ann Arbor Bid documents from other sources, it is recommended that you register on www.MITN.info and obtain an official Bid. Bidders do not need to be shown on the plan holders list provided by MITN to be considered an official plan holder.

Bid Security

Each bid must be accompanied by a certified check or Bid Bond by a surety licensed and authorized to do business within the State of Michigan, in the amount of 5% of the total of the bid price.

Withdrawal of Bids

After the time of opening, no Bid may be withdrawn for the period of ninety (90) days

Contract Time

Time is of the essence in the performance of the work under this Contract. The available time for work under this Contract is indicated on page C-2, Article III of the Contract. If these time requirements cannot be met, the Bidder must stipulate on Bid Form Section 3 - Time Alternate its schedule for performance of the work. Consideration will be given to time in evaluating bids.

Liquidated Damages

A liquidated damages clause, as given on page C-2, Article III of the Contract, provides that the Contractor shall pay the City as liquidated damages, and not as a penalty, a sum certain per day for each and every day that the Contractor may be in default of completion of the specified work, within the time(s) stated in the Contract, or written extensions.

Liquidated damages clauses, as given in the General Conditions, provide further that the City shall be entitled to impose and recover liquidated damages for breach of the obligations under Chapter 112 of the City Code.

The liquidated damages are for the non-quantifiable aspects of any of the previously identified events and do not cover actual damages that can be shown or quantified nor are they intended to preclude recovery of actual damages in addition to the recovery of liquidated damages.

Human Rights Information

All contractors proposing to do business with the City shall satisfy the contract compliance administrative policy adopted by the City Administrator in accordance with the Section 9:158 of the Ann Arbor City Code. Breach of the obligation not to discriminate as outlined in Section 5, beginning at page GC-2 shall be a material breach of the contract. Contractors are required to post a copy of Ann Arbor's Non-Discrimination Ordinance attached at all work locations where its employees provide services under a contract with the City.

Wage Requirements

Section 4, beginning at page GC-1, outlines the requirements for payment of prevailing wages and for payment of a "living wage" to employees providing service to the City under this contract. The successful bidder and its subcontractors must comply with all applicable requirements and provide proof of compliance.

Pursuant to Resolution R-16-469 all public improvement contractors are subject to prevailing wage and will be required to provide to the City payroll records sufficient to demonstrate compliance with the prevailing wage requirements. Use of the Prevailing Wage Form provided in the Appendix section or a City-approved equivalent will be required along with wage rate interviews.

For laborers whose wage level are subject to federal, state and/or local prevailing wage law the appropriate Davis-Bacon wage rate classification is identified based upon the work including within this contract. **The wage determination(s) current on the date 10 days before bids are due shall apply to this contract.** The U.S. Department of Labor (DOL) has provided explanations to assist with classification in the following resource link: beta.SAM.gov.

For the purposes of this ITB the Construction Type of Heavy will apply.

Conflict of Interest Disclosure

The City of Ann Arbor Purchasing Policy requires that prospective Vendors complete a Conflict of Interest Disclosure form. A contract may not be awarded to the selected Vendor unless and until the Procurement Unit and the City Administrator have reviewed the Disclosure form and determined that no conflict exists under applicable federal, state, or local law or administrative regulation. Not every relationship or situation disclosed on the Disclosure Form may be a disqualifying conflict. Depending on applicable law and regulations, some contracts may awarded on the recommendation of the City Administrator after full disclosure, where such action is allowed by law, if demonstrated competitive pricing exists and/or it is determined the award is in the best interest of the City. A copy of the Vendor Conflict of Interest Disclosure Form is attached.

Major Subcontractors

The Bidder shall identify on Bid Form Section 4 each major subcontractor it expects to engage for this Contract if the work to be subcontracted is 15% or more of the bid sum or over \$50,000, whichever is less or as noted on Bid Form Section 4. The Bidder also shall identify the work to be subcontracted to each major subcontractor. The Bidder shall not change or replace a subcontractor without approval by the City.

Debarment

Submission of a Bid in response to this ITB is certification that the Bidder is not currently debarred,

suspended, proposed for debarment, and declared ineligible or voluntarily excluded from participation in this transaction by any State or Federal departments or agency. Submission is also agreement that the City will be notified of any changes in this status.

Disclosures

After bids are opened, all information in a submitter's bid is subjected to disclosure under the provisions of Michigan Public Act No. 442 of 1976, as amended (MCL 15.231 et seq.) known as the "Freedom of Information Act." The Freedom of Information Act also provides for the complete disclosure of contracts and attachments thereto except where specifically exempted.

Bid Protest

All Bid protests must be in writing and filed with the Purchasing Agent within five (5) business days of the award action. The bidder must clearly state the reasons for the protest. If a bidder contacts a City Service Area/Unit and indicates a desire to protest an award, the Service Area/Unit shall refer the bidder to the Purchasing Agent. The Purchasing Agent will provide the bidder with the appropriate instructions for filing the protest. The protest shall be reviewed by the City Administrator or designee whose decision shall be final.

Any inquiries or requests regarding this procurement should be only submitted in writing to the Designated City Contacts provided herein. Attempts by any prospective bidder to initiate contact with anyone other than the Designated City Contacts provided herein that the bidder believes can influence the procurement decision, e.g., Elected Officials, City Administrator, Selection Committee Members, Appointed Committee Members, etc., may lead to immediate elimination from further consideration.

Cost Liability

The City of Ann Arbor assumes no responsibility or liability for costs incurred by the Bidder prior to the execution of a contract with the City. By submitting a bid, a bidder agrees to bear all costs incurred or related to the preparation, submission and selection process for the bid.

Reservation of Rights

The City of Ann Arbor reserves the right to accept any bid or alternative bid proposed in whole or in part, to reject any or all bids or alternatives bids in whole or in part and to waive irregularity and/or informalities in any bid and to make the award in any manner deemed in the best interest of the City.

Idle Free Ordinance

The City of Ann Arbor adopted an idling reduction Ordinance that goes into effect July 1, 2017. The full text of the ordinance (including exemptions) can be found at: www.a2gov.org/idlefree.

Under the ordinance, No Operator of a Commercial Vehicle shall cause or permit the Commercial Vehicle to Idle:

- (a) For any period of time while the Commercial Vehicle is unoccupied; or
- (b) For more than 5 minutes in any 60-minute period while the Commercial Vehicle is occupied.

In addition, generators and other internal combustion engines are covered

- (1) Excluding Motor Vehicle engines, no internal combustion engine shall be operated except

when it is providing power or electrical energy to equipment or a tool that is actively in use.

Environmental Commitment

The City of Ann Arbor recognizes its responsibility to minimize negative impacts on human health and the environment while supporting a vibrant community and economy. The City further recognizes that the products and services the City buys have inherent environmental and economic impacts and that the City should make procurement decisions that embody, promote, and encourage the City's commitment to the environment.

The City encourages potential vendors to bring forward emerging and progressive products and services that are best suited to the City's environmental principles.

Existing Site Conditions

Owner has included reports and drawings related to this project within the Appendices of these Bidding Documents. These reports and drawings are not part of the Contract Documents, but the Technical Data contained therein upon whose accuracy Bidder is entitled to rely, as provided in the General Conditions, has been identified and established herein. Bidder is responsible for any interpretation or conclusion Bidder draws from any Technical Data or any other data, interpretations, opinions, or information contained in such reports or shown or indicated in such drawings.

Underground Facilities: Information and data shown or indicated in the Bidding Documents with respect to existing Underground Facilities at or contiguous to the Site are set forth in the Contract Documents and are based upon information and data furnished to Owner and Engineer by owners of such Underground Facilities, including Owner, or others.

Adequacy of Data: Provisions concerning responsibilities for the adequacy of data furnished to prospective Bidders with respect to subsurface conditions, other physical conditions, and Underground Facilities, and possible changes in the Bidding Documents due to differing or unanticipated subsurface or physical conditions appear in Section 3 of the General Conditions.

Site Visit and Testing by Bidders

- A. Bidder shall conduct the required Site visit during normal working hours and shall not disturb any ongoing operations at the Site.**
- B. Bidder is not required to conduct any subsurface testing, or exhaustive investigations of Site conditions.**
- C. On request, and to the extent Owner has control over the Site, and schedule permitting, the Owner will provide Bidder access to the Site to conduct such additional examinations, investigations, explorations, tests, and studies as Bidder deems necessary for preparing and submitting a successful Bid. Owner will not have any obligation to grant such access if doing so is not practical because of existing operations, security or safety concerns, or restraints on Owner's authority regarding the Site.**
- D. Bidder shall comply with all applicable Laws and Regulations regarding excavation and location of utilities, obtain all permits, and comply with all terms and conditions established by Owner or by property owners or other entities controlling the Site with respect to schedule, access, existing operation, security, liability insurance, and applicable safety programs.**

E. Bidder shall fill all holes and clean up and restore the Site to its former condition upon completion of such explorations, investigations, tests, and studies.

INVITATION TO BID

City of Ann Arbor
Guy C. Larcom Municipal Building
Ann Arbor, Michigan 48107

Ladies and Gentlemen:

The undersigned, as Bidder, declares that this Bid is made in good faith, without fraud or collusion with any person or persons bidding on the same Contract; that this Bidder has carefully read and examined the bid documents, including City Nondiscrimination requirements and Declaration of Compliance Form, Living Wage requirements and Declaration of Compliance Form, Prevailing Wage requirements and Declaration of Compliance Form, Vendor Conflict of Interest Form, Notice of Pre-Bid Conference, Instructions to Bidders, Bid, Bid Forms, Contract, Bond Forms, General Conditions, Standard Specifications, Detailed Specifications, all Addenda, and the Plans (if applicable) and understands them. The Bidder declares that it conducted a full investigation at the site and of the work proposed and is fully informed as to the nature of the work and the conditions relating to the work's performance. The Bidder also declares that it has extensive experience in successfully completing projects similar to this one.

The Bidder acknowledges that it has not received or relied upon any representations or warrants of any nature whatsoever from the City of Ann Arbor, its agents or employees, and that this Bid is based solely upon the Bidder's own independent business judgment.

The undersigned proposes to perform all work shown on the plans or described in the bid documents, including any addenda issued, and to furnish all necessary machinery, tools, apparatus, and other means of construction to do all the work, furnish all the materials, and complete the work in strict accordance with all terms of the Contract of which this Bid is one part.

In accordance with these bid documents, and Addenda numbered _____, the undersigned, as Bidder, proposes to perform at the sites in and/or around Ann Arbor, Michigan, all the work included herein for the amounts set forth in the Bid Forms.

The Bidder declares that it has become fully familiar with the liquidated damage clauses for completion times and for compliance with City Code Chapter 112, understands and agrees that the liquidated damages are for the non-quantifiable aspects of non-compliance and do not cover actual damages that may be shown and agrees that if awarded the Contract, all liquidated damage clauses form part of the Contract.

The Bidder declares that it has become fully familiar with the provisions of Chapter 14, Section 1:320 (Prevailing wages) and Chapter 23 (Living Wage) of the Code of the City of Ann Arbor and that it understands and agrees to comply, to the extent applicable to employees providing services to the City under this Contract, with the wage and reporting requirements stated in the City Code provisions cited. Bidder certifies that the statements contained in the City Prevailing Wage and Living Wage Declaration of Compliance Forms are true and correct. Bidder further agrees that the cited provisions of Chapter 14 and Chapter 23 form a part of this Contract.

The Bidder declares that it has become familiar with the City Conflict of Interest Disclosure Form and certifies that the statement contained therein is true and correct.

The Bidder encloses a certified check or Bid Bond in the amount of 5% of the total of the Bid Price. The Bidder agrees both to contract for the work and to furnish the necessary Bonds and insurance documentation within 10 days after being notified of the acceptance of the Bid.

If this Bid is accepted by the City and the Bidder fails to contract and furnish the required Bonds and insurance documentation within 10 days after being notified of the acceptance of this Bid, then the Bidder shall be considered to have abandoned the Contract and the certified check or Bid Bond accompanying this Bid shall become due and payable to the City.

If the Bidder enters into the Contract in accordance with this Bid, or if this Bid is rejected, then the accompanying check or Bid Bond shall be returned to the Bidder.

In submitting this Bid, it is understood that the right is reserved by the City to accept any Bid, to reject any or all Bids, to waive irregularities and/or informalities in any Bid, and to make the award in any manner the City believes to be in its best interest.

SIGNED THIS _____ DAY OF _____, 202_.

Bidder's Name

Authorized Signature of Bidder

Official Address

(Print Name of Signer Above)

Telephone Number

Email Address for Award Notice

LEGAL STATUS OF BIDDER

(The Bidder shall fill out the appropriate form and strike out the other three.)

Bidder declares that it is:

* A corporation organized and doing business under the laws of the State of _____, for whom _____, bearing the office title of _____, whose signature is affixed to this Bid, is authorized to execute contracts.

NOTE: If not incorporated in Michigan, please attach the corporation's Certificate of Authority

• A limited liability company doing business under the laws of the State of _____, whom _____ bearing the title of _____ whose signature is affixed to this proposal, is authorized to execute contract on behalf of the LLC.

* A partnership, organized under the laws of the state of _____ and filed in the county of _____, whose members are (list all members and the street and mailing address of each) (attach separate sheet if necessary):

* An individual, whose signature with address, is affixed to this Bid: _____
(initial here)

Authorized Official

_____ **Date** _____, 202_

(Print) Name _____ Title _____

Company: _____

Address: _____

Contact Phone () _____ Fax () _____

Email _____

BID FORM

Section 1 – Schedule of Prices

Company: _____

Project: **ITB# 4680 - WWTP Clear Well Improvements**

Unit Price Bid

Item No.	Description	Estimated Quantity	Bid Unit Price	Bid Price
1	Clear Well Improvements	LS	\$	\$
2	Remove & Replace Pressure Relief Valve	24 EA	\$	\$
3	Concrete Joint Sealer Repair, Repair Detail R2	75 LF	\$	\$
4	Urethane Crack Injection Repair, Repair Detail R16	250 LF	\$	\$
5	Delaminated Concrete Repair, Repair Detail R10	1,200 Sq Inches	\$	\$

Total Base Bid for Items 1 through 5	\$
---	----

CONTRACT ALTERNATES

Contractor is required to provide a quote as part of Bid for the following work which Owner may/may not elect to consider:

Item Number	Description	Add/Deduct	Amount
Alternate No. 1	Limit air header demolition to extent shown on Drawings		\$

BID FORM

Section 2 – Material, Equipment and Environmental Alternates

The Base Bid proposal price shall include materials and equipment selected from the designated items and manufacturers listed in the bidding documents. This is done to establish uniformity in bidding and to establish standards of quality for the items named.

If the Contractor wishes to quote alternate items for consideration by the City, it may do so under this Section. A complete description of the item and the proposed price differential must be provided. Unless approved at the time of award, substitutions where items are specifically named will be considered only as a negotiated change in Contract Sum.

If an environmental alternative is bid the City strongly encourages bidders to provide recent examples of product testing and previous successful use for the City to properly evaluate the environmental alternative. Testing data from independent accredited organizations are strongly preferred.

<u>Item Number</u>	<u>Description</u>	<u>Add/Deduct Amount</u>
--------------------	--------------------	--------------------------

If the Bidder does not suggest any material or equipment alternate, the Bidder **MUST** complete the following statement:

For the work outlined in this request for bid, the bidder does NOT propose any material or equipment alternate under the Contract.

Signature of Authorized Representative of Bidder _____ Date _____

BID FORM

Section 3 - Time Alternate

If the Bidder takes exception to the time stipulated in Article III of the Contract, Time of Completion, page C-2, it is requested to stipulate below its proposed time for performance of the work. Consideration will be given to time in evaluating bids.

If the Bidder does not suggest any time alternate, the Bidder **MUST** complete the following statement:

For the work outlined in this request for bid, the bidder does NOT propose any time alternate under the Contract.

Signature of Authorized Representative of Bidder _____ Date _____

BID FORM

Section 4 - Major Subcontractors

For purposes of this Contract, a Subcontractor is anyone (other than the Contractor) who performs work (other than or in addition to the furnishing of materials, plans or equipment) at or about the construction site, directly or indirectly for or on behalf of the Contractor (and whether or not in privity of Contract with the Contractor), but shall not include any individual who furnishes merely the individual's own personal labor or services.

Contractor agrees that all subcontracts entered into by the Contractor shall contain similar wage provision to Section 4 of the General Conditions covering subcontractor's employees who perform work on this contract.

For the work outlined in these documents the Bidder expects to engage the following major subcontractors to perform the work identified:

<u>Subcontractor/Manufacturers (Name and Address)</u>	<u>Work</u>	<u>Amount</u>
	<u>Mechanical (Sub)Contractor</u>	
	<u>Electrical (Sub)Contractor</u>	
	<u>Demolition (Sub)Contractor</u>	
	<u>Concrete Restoration (Sub)Contractor</u>	
	<u>Clear Well Cleaning (Sub)Contractor</u>	
	<u>Aeration Equipment Manufacturer</u>	

If the Bidder does not expect to engage any major subcontractor, the Bidder **MUST** complete the following statement:

For the work outlined in this request for bid, the bidder does NOT expect to engage any major subcontractor to perform work under the Contract.

Signature of Authorized Representative of Bidder _____ Date _____

BID FORM

Section 5 – References

Include a minimum of 3 references from similar project completed within the past 10 years.

[Refer also to Instructions to Bidders for additional requirements, if any]

1) _____
Project Name Cost Date Constructed

_____ Phone Number
Contact Name

2) _____
Project Name Cost Date Constructed

_____ Phone Number
Contact Name

3) _____
Project Name Cost Date Constructed

_____ Phone Number
Contact Name

4) _____
Project Name Cost Date Constructed

_____ Phone Number
Contact Name

5) _____
Project Name Cost Date Constructed

_____ Phone Number
Contact Name

BID FORM

Section 6 – Contractor Information and Responsible Contractor Criteria

Backup documentation may be requested at the sole discretion of the City to validate all of the responses provided herein by bidders. False statements by bidders to any of the criteria provided herein will result in the bid being considered non-responsive and will not be considered for award.

Failure to provide responses to all questions may result in being deemed non-responsive.

Attach additional pages as needed if space below is insufficient.

Pursuant to Sec 1:312(20) of the City Code which sets forth requirements of a responsible bidder, Bidder is required to submit the following:

1. Organization Name: _____

Social Security or Federal Employer I.D. #: _____

Address: _____

City: _____ State: _____ Zip: _____

Type of Organization (circle one below):

Individual Partnership Corporation Joint Venture Other

If "Other" please provide details on the organization:

Year organization established: _____

2. Current owners/principals/members/managing members/partners of the organization:

3. Assumed Names, "doing business as" d/b/a, and/or former organization names(s), if applicable: _____

Explanation of any business name changes:

4. If applicable, please provide a list of all bidder's litigation and arbitrations currently pending and within the past five years, including an explanation of each (parties, court/forum, legal claims, damages sought, and resolution).

5. Qualifications of management and supervisory personnel to be assigned by the bidder:

6. List the state and local licenses and license numbers held by the bidder:

7. Will all subcontractors, employees and other individuals working on the construction project maintain current applicable licenses required by law for all licensed occupations and professions?

Yes

No

8. Will contractors, subcontractors, employees, and other individuals working on the construction project be misclassified by bidder as independent contractors in violation of state or federal law?

Yes

No

9. Submit a statement as to what percentage of your work force resides within the City of Ann Arbor, and what percentage resides in Washtenaw County, Michigan, and the same information for any major subcontractors.

10. Submit documentation as to bidder's employee pay rates (e.g., certified payroll without SSN or personal identifying information, or chart of job titles and pay rates, or other evidence).

11. State whether bidder provides health insurance, pension or other retirement benefits, paid leave (vacation, personal time, sick leave, etc), or other benefits to its employees, and if so, state whether each benefit is provided directly to employees, by payments or contributions to a third-party administered plan, in cash (e.g., fringe benefit portion of prevailing wages), or other manner.

12. State whether bidder is an equal opportunity employer and does not discriminate in its hiring on the basis of race, sex, pregnancy, age, religion, national origin, marital status, sexual orientation or gender identity, height, weight, or disability.

Yes

No

13. State whether bidder has Equal Employment Opportunity Programs for minorities, women, veterans, returning citizens, and small businesses, and if so, submit supporting documentation or other evidence of such program(s).

14. Has bidder had any violations of state, federal, or local laws or regulations, including OSHA or MIOSHA violations, state or federal prevailing wage laws, wage and hour laws, worker's compensation or unemployment compensation laws, rules or regulations, issued to or against the bidder within the past five years?

Yes

No

If you answered "yes" to the question above, for each violation provide an explanation of the nature of the violation, the agency involved, a violation or reference number, any other individual(s) or party(ies) involved, and the status or outcome and resolution.

15. Does bidder have an existing Fitness for Duty Program (drugs and alcohol testing) of each employee working on the proposed jobsite?

Yes

No

If you answered "Yes", please submit documentation of the Fitness for Duty Program and what it entails.

16. Submit documents or evidence of any debarment by any federal, state or local governmental unit and/or findings of non-responsibility or non-compliance with respect to any public or private construction project performed by the bidder.

17. Proof of insurance, including certificates of insurance, confirming existence and amount of coverage for liability, property damage, workers compensation, and any other insurances required by the proposed contract documents.

18. Does bidder have an on-going MIOSHA-approved safety-training program for employees to be used on the proposed job site?

Yes

No

If bidder answered "yes" to the question above, submit documentation of your safety-training program.

19. Does bidder have evidence of worker's compensation Experience Modification Rating ("EMR")?

Yes

No

EMR = _____

20. Will bidder use masters, journeypersons and apprentices on the project?

Yes

No

If bidder answered "yes" to the question above, provide the ratio of masters and journeypersons to apprentices for this project.

Ratio: _____

If bidder answered "no" to the question above, submit documentation regarding the qualifications of each worker who may or will be assigned on the project.

If, yes, Ratio = _____

21. Can bidder provide documentation that it participates in a Registered Apprenticeship Program (RAP) that is registered with the United States Department of Labor Office of Apprenticeship or by a State Apprenticeship Agency recognized by the Office of Apprenticeship?

Yes

No

If bidder answered "yes" to the question above, please submit a copy of the program document(s) and evidence of its registration.

If bidder answered "no" to the question above, please provide details on how you assess the skills and qualifications of any employees who do not have master or journeyperson certification or status, or are not participants in a Registered Apprenticeship Program.

22. Will bidder comply with all applicable state and federal laws and visa requirements regarding the hiring of non-US citizens, and disclosure of any work visas sought or obtained by the bidder, any of the bidder's subcontractors, or any of the bidder's employees or independent contractors, in order to perform any portion of the project?

Yes

No

23. Submit evidence that bidder has financial resources to start up and follow through on the project and to respond to damages in case of default as show by written verification of bonding capacity equal to or exceeding the amount of the bidders scope of work on the project. The written verification must be submitted by a licensed surety company rated B+ or better in the current A.M. Best Guide and qualified to do business within the State of Michigan, and the same audited financial information for any subcontractor estimated to be paid more than \$100,000 related to any portion of the project.

24. Submit evidence of a quality assurance program used by the bidder and the results of same on the bidder's previous projects.

SAMPLE STANDARD CONTRACT

If a contract is awarded, the selected contractor will be required to adhere to a set of general contract provisions which will become a part of any formal agreement. These provisions are general principles which apply to all contractors of service to the City of Ann Arbor such as the following:

Administrative Use Only
Contract Date: _____

CONTRACT

THIS CONTRACT is between the CITY OF ANN ARBOR, a Michigan Municipal Corporation, 301 East Huron Street, Ann Arbor, Michigan 48104 ("City") and _____ ("Contractor") _____ (An individual/partnership/corporation, include state of incorporation) _____ (Address). Based upon the mutual promises below, the Contractor and the City agree as follows:

ARTICLE I - Scope of Work

The Contractor agrees to furnish all of the materials, equipment and labor necessary; and to abide by all the duties and responsibilities applicable to it for the project titled **[Insert Title of Bid and Bid Number]** in accordance with the requirements and provisions of the following documents, including all written modifications incorporated into any of the documents, all of which are incorporated as part of this Contract:

Non-discrimination and Living Wage Declaration of Compliance Forms (if applicable)	General Conditions
Vendor Conflict of Interest Form	Standard Specifications
Prevailing Wage Declaration of Compliance Form (if applicable)	Detailed Specifications
Bid Forms	Plans
Contract and Exhibits	Addenda
Bonds	

ARTICLE II - Definitions

Administering Service Area/Unit means **Public Services Area / Wastewater Treatment Services Unit.**

Project means **WWTP Clear Well Improvements [Bid Number], located at 49 Old Dixboro Road, Ann Arbor, Michigan.**

Supervising Professional means the person acting under the authorization of the manager of the Administering Service Area/Unit. At the time this Contract is executed, the Supervising

Professional is **Christopher Englert, P.E.** whose job title is **Wastewater Treatment Services Engineer**. If there is any question concerning who the Supervising Professional is, Contractor shall confirm with the manager of the Administering Service Area/Unit.

Contractor's Representative means _____ **[Insert name]** whose job title is _____ **[Insert job title]**.

ARTICLE III - Time of Completion

- (A) The work to be completed under this Contract shall begin immediately on the date specified in the Notice to Proceed issued by the City.
- (B) The entire work for this Contract shall be substantially completed within four hundred (400) consecutive calendar days. The Final Completion date for the entire work for this Contract shall be four hundred thirty (430) consecutive calendar days.
- (C) Failure to complete all the work within the time specified above, including any extension granted in writing by the Supervising Professional, shall obligate the Contractor to pay the City, as liquidated damages and not as a penalty, an amount equal to \$1,100.00 for each calendar day of delay in the completion of all the work. If any liquidated damages are unpaid by the Contractor, the City shall be entitled to deduct these unpaid liquidated damages from the monies due the Contractor.

The liquidated damages are for the non-quantifiable aspects of any of the previously identified events and do not cover actual damages that can be shown or quantified nor are they intended to preclude recovery of actual damages in addition to the recovery of liquidated damages.

ARTICLE IV - The Contract Sum

- (A) The City shall pay to the Contractor for the performance of the Contract, the unit prices as given in the Bid Form for the estimated bid total of:

_____ Dollars (\$ _____)

- (B) The amount paid shall be equitably adjusted to cover changes in the work ordered by the Supervising Professional but not required by the Contract Documents. Increases or decreases shall be determined only by written agreement between the City and Contractor.

ARTICLE V - Assignment

This Contract may not be assigned or subcontracted any portion of any right or obligation under this contract without the written consent of the City. Notwithstanding any consent by the City to any assignment, Contractor shall at all times remain bound to all warranties, certifications, indemnifications, promises and performances, however described, as are required of it under this contract unless specifically released from the requirement, in writing, by the City.

ARTICLE VI - Choice of Law

This Contract shall be construed, governed, and enforced in accordance with the laws of the State of Michigan. By executing this Contract, the Contractor and the City agree to venue in a court of appropriate jurisdiction sitting within Washtenaw County for purposes of any action arising under this Contract. The parties stipulate that the venue referenced in this Contract is for convenience and waive any claim of non-convenience.

Whenever possible, each provision of the Contract will be interpreted in a manner as to be effective and valid under applicable law. The prohibition or invalidity, under applicable law, of any provision will not invalidate the remainder of the Contract.

ARTICLE VII - Relationship of the Parties

The parties of the Contract agree that it is not a Contract of employment but is a Contract to accomplish a specific result. Contractor is an independent Contractor performing services for the City. Nothing contained in this Contract shall be deemed to constitute any other relationship between the City and the Contractor.

Contractor certifies that it has no personal or financial interest in the project other than the compensation it is to receive under the Contract. Contractor certifies that it is not, and shall not become, overdue or in default to the City for any Contract, debt, or any other obligation to the City including real or personal property taxes. City shall have the right to set off any such debt against compensation awarded for services under this Contract.

ARTICLE VIII - Notice

All notices given under this Contract shall be in writing, and shall be by personal delivery or by certified mail with return receipt requested to the parties at their respective addresses as specified in the Contract Documents or other address the Contractor may specify in writing. Notice will be deemed given on the date when one of the following first occur: (1) the date of actual receipt; or (2) three days after mailing certified U.S. mail.

ARTICLE IX - Indemnification

To the fullest extent permitted by law, Contractor shall indemnify, defend and hold the City, its officers, employees and agents harmless from all suits, claims, judgments and expenses including attorney's fees resulting or alleged to result, in whole or in part, from any act or omission, which is in any way connected or associated with this Contract, by the Contractor or anyone acting on the Contractor's behalf under this Contract. Contractor shall not be responsible to indemnify the City for losses or damages caused by or resulting from the City's sole negligence. The provisions of this Article shall survive the expiration or earlier termination of this contract for any reason.

ARTICLE X - Entire Agreement

This Contract represents the entire understanding between the City and the Contractor and it supersedes all prior representations, negotiations, agreements, or understandings whether written or oral. Neither party has relied on any prior representations in entering into this Contract. No terms or conditions of either party's invoice, purchase order or other administrative document shall modify the terms and conditions of this Contract, regardless of the other party's failure to object to such form. This Contract shall be binding on and shall inure to the benefit of the parties

to this Contract and their permitted successors and permitted assigns and nothing in this Contract, express or implied, is intended to or shall confer on any other person or entity any legal or equitable right, benefit, or remedy of any nature whatsoever under or by reason of this Contract. This Contract may be altered, amended or modified only by written amendment signed by the City and the Contractor.

ARTICLE XI – Electronic Transactions

The City and Contractor agree that signatures on this Contract may be delivered electronically in lieu of an original signature and agree to treat electronic signatures as original signatures that bind them to this Contract. This Contract may be executed and delivered by facsimile and upon such delivery, the facsimile signature will be deemed to have the same effect as if the original signature had been delivered to the other party.

FOR CONTRACTOR

By _____

Its: _____

FOR THE CITY OF ANN ARBOR

By _____
Christopher Taylor, Mayor

By _____
Jacqueline Beaudry, City Clerk

Approved as to substance

By _____
Tom Crawford, City Administrator

By _____
Craig Hupy, PE,
Public Services Area Administrator

Approved as to form and content

Stephen K. Postema, City Attorney

PERFORMANCE BOND

- (1) _____ of _____ (referred to as "Principal"), and _____, a corporation duly authorized to do business in the State of Michigan (referred to as "Surety"), are bound to the City of Ann Arbor, Michigan (referred to as "City"), for \$_____, the payment of which Principal and Surety bind themselves, their heirs, executors, administrators, successors and assigns, jointly and severally, by this bond.
- (2) The Principal has entered a written Contract with the City entitled WWTP Clear Well Improvements for ITB No. _____ and this bond is given for that Contract in compliance with Act No. 213 of the Michigan Public Acts of 1963, as amended, being MCL 129.201 et seq.
- (3) Whenever the Principal is declared by the City to be in default under the Contract, the Surety may promptly remedy the default or shall promptly:
 - (a) complete the Contract in accordance with its terms and conditions; or
 - (b) obtain a bid or bids for submission to the City for completing the Contract in accordance with its terms and conditions, and upon determination by Surety of the lowest responsible bidder, arrange for a Contract between such bidder and the City, and make available, as work progresses, sufficient funds to pay the cost of completion less the balance of the Contract price; but not exceeding, including other costs and damages for which Surety may be liable hereunder, the amount set forth in paragraph 1.
- (4) Surety shall have no obligation to the City if the Principal fully and promptly performs under the Contract.
- (5) Surety agrees that no change, extension of time, alteration or addition to the terms of the Contract or to the work to be performed thereunder, or the specifications accompanying it shall in any way affect its obligations on this bond, and waives notice of any such change, extension of time, alteration or addition to the terms of the Contract or to the work, or to the specifications.
- (6) Principal, Surety, and the City agree that signatures on this bond may be delivered electronically in lieu of an original signature and agree to treat electronic signatures as original signatures that bind them to this bond. This bond may be executed and delivered by facsimile and upon such delivery, the facsimile signature will be deemed to have the same effect as if the original signature had been delivered to the other party.

SIGNED AND SEALED this _____ day of _____, 202_.

(Name of Surety Company)

By _____
(Signature)

Its _____
(Title of Office)

Approved as to form:

Stephen K. Postema, City Attorney

(Name of Principal)

By _____
(Signature)

Its _____
(Title of Office)

Name and address of agent:

LABOR AND MATERIAL BOND

- (1) _____
of _____ (referred to as "Principal"), and _____, a corporation duly authorized to do business in the State of Michigan, (referred to as "Surety"), are bound to the City of Ann Arbor, Michigan (referred to as "City"), for the use and benefit of claimants as defined in Act 213 of Michigan Public Acts of 1963, as amended, being MCL 129.201 et seq., in the amount of \$ _____, for the payment of which Principal and Surety bind themselves, their heirs, executors, administrators, successors and assigns, jointly and severally, by this bond.
- (2) The Principal has entered a written Contract with the City entitled WWTP Clear Well Improvements for ITB No. _____; and this bond is given for that Contract in compliance with Act No. 213 of the Michigan Public Acts of 1963 as amended;
- (3) If the Principal fails to promptly and fully repay claimants for labor and material reasonably required under the Contract, the Surety shall pay those claimants.
- (4) Surety's obligations shall not exceed the amount stated in paragraph 1, and Surety shall have no obligation if the Principal promptly and fully pays the claimants.
- (5) Principal, Surety, and the City agree that signatures on this bond may be delivered electronically in lieu of an original signature and agree to treat electronic signatures as original signatures that bind them to this bond. This bond may be executed and delivered by facsimile and upon such delivery, the facsimile signature will be deemed to have the same effect as if the original signature had been delivered to the other party.

SIGNED AND SEALED this _____ day of _____, 202_

(Name of Surety Company)

By _____
(Signature)

Its _____
(Title of Office)

Approved as to form:

Stephen K. Postema, City Attorney

(Name of Principal)

By _____
(Signature)

Its _____
(Title of Office)

Name and address of agent:

GENERAL CONDITIONS

Note: Revisions and/or modifications to these General Conditions have been “**bolded**” and “**underlined**” when content has been added and “~~stuck through~~” when content has been deleted.

Section 1 - Execution, Correlation and Intent of Documents

The contract documents shall be signed in 2 copies by the City and the Contractor.

The contract documents are complementary and what is called for by any one shall be binding. The intention of the documents is to include all labor and materials, equipment and transportation necessary for the proper execution of the work. Materials or work described in words which so applied have a well-known technical or trade meaning have the meaning of those recognized standards.

In case of a conflict among the contract documents listed below in any requirement(s), the requirement(s) of the document listed first shall prevail over any conflicting requirement(s) of a document listed later.

(1) Addenda in reverse chronological order; (2) Detailed Specifications; (3) Standard Specifications; (4) Plans; (5) General Conditions; (6) Contract; (7) Bid Forms; (8) Bond Forms; (9) Bid.

Section 2 - Order of Completion

The Contractor shall submit with each invoice, and at other times reasonably requested by the Supervising Professional, schedules showing the order in which the Contractor proposes to carry on the work. They shall include the dates at which the Contractor will start the several parts of the work, the estimated dates of completion of the several parts, and important milestones within the several parts.

Section 3 - Familiarity with Work

The Bidder or its representative shall make personal investigations of the site of the work and of existing structures and shall determine to its own satisfaction the conditions to be encountered, the nature of the ground, the difficulties involved, and all other factors affecting the work proposed under this Contract. The Bidder to whom this Contract is awarded will not be entitled to any additional compensation unless conditions are clearly different from those which could reasonably have been anticipated by a person making diligent and thorough investigation of the site.

The Bidder shall immediately notify the City upon discovery, and in every case prior to submitting its Bid, of every error or omission in the bidding documents that would be identified by a reasonably competent, diligent Bidder. In no case will a Bidder be allowed the benefit of extra compensation or time to complete the work under this Contract for extra expenses or time spent as a result of the error or omission.

Section 4 - Wage Requirements

Under this Contract, the Contractor shall conform to Chapter 14 of Title I of the Code of the City of Ann Arbor as amended; which in part states "...that all craftsmen, mechanics and laborers

employed directly on the site in connection with said improvements, including said employees of subcontractors, shall receive the prevailing wage for the corresponding classes of craftsmen, mechanics and laborers, as determined by statistics for the Ann Arbor area compiled by the United States Department of Labor. At the request of the City, any contractor or subcontractor shall provide satisfactory proof of compliance with the contract provisions required by the Section.

Pursuant to Resolution R-16-469 all public improvement contractors are subject to prevailing wage and will be required to provide to the City payroll records sufficient to demonstrate compliance with the prevailing wage requirements. A sample Prevailing Wage Form is provided in the Appendix herein for reference as to what will be expected from contractors. Use of the Prevailing Wage Form provided in the Appendix section or a City-approved equivalent will be required along with wage rate interviews.

Where the Contract and the Ann Arbor City Ordinance are silent as to definitions of terms required in determining contract compliance with regard to prevailing wages, the definitions provided in the Davis-Bacon Act as amended (40 U.S.C. 278-a to 276-a-7) for the terms shall be used.

If the Contractor is a "covered employer" as defined in Chapter 23 of the Ann Arbor City Code, the Contractor agrees to comply with the living wage provisions of Chapter 23 of the Ann Arbor City Code. The Contractor agrees to pay those employees providing Services to the City under this Contract a "living wage," as defined in Section 1:815 of the Ann Arbor City Code, as adjusted in accordance with Section 1:815(3); to post a notice approved by the City of the applicability of Chapter 23 in every location in which regular or contract employees providing services under this Contract are working; to maintain records of compliance; if requested by the City, to provide documentation to verify compliance; to take no action that would reduce the compensation, wages, fringe benefits, or leave available to any employee or person contracted for employment in order to pay the living wage required by Section 1:815; and otherwise to comply with the requirements of Chapter 23.

Contractor agrees that all subcontracts entered into by the Contractor shall contain similar wage provision covering subcontractor's employees who perform work on this contract.

Section 5 - Non-Discrimination

The Contractor agrees to comply, and to require its subcontractor(s) to comply, with the nondiscrimination provisions of MCL 37.2209. The Contractor further agrees to comply with the provisions of Section 9:158 of Chapter 112 of Title IX of the Ann Arbor City Code, and to assure that applicants are employed and that employees are treated during employment in a manner which provides equal employment opportunity.

Section 6 - Materials, Appliances, Employees

Unless otherwise stipulated, the Contractor shall provide and pay for all materials, labor, water, tools, equipment, light, power, transportation, and other facilities necessary or used for the execution and completion of the work. Unless otherwise specified, all materials incorporated in the permanent work shall be new, and both workmanship and materials shall be of the highest quality. The Contractor shall, if required, furnish satisfactory evidence as to the kind and quality of materials.

The Contractor shall at all times enforce strict discipline and good order among its employees,

and shall seek to avoid employing on the work any unfit person or anyone not skilled in the work assigned.

Adequate sanitary facilities shall be provided by the Contractor.

Section 7 - Qualifications for Employment

The Contractor shall employ competent laborers and mechanics for the work under this Contract. For work performed under this Contract, employment preference shall be given to qualified local residents.

Section 8 - Royalties and Patents

The Contractor shall pay all royalties and license fees. It shall defend all suits or claims for infringements of any patent rights and shall hold the City harmless from loss on account of infringement except that the City shall be responsible for all infringement loss when a particular process or the product of a particular manufacturer or manufacturers is specified, unless the City has notified the Contractor prior to the signing of the Contract that the particular process or product is patented or is believed to be patented.

Section 9 - Permits and Regulations

The Contractor must secure and pay for all permits, permit or plan review fees and licenses necessary for the prosecution of the work. These include but are not limited to City building permits, right-of-way permits, lane closure permits, right-of-way occupancy permits, and the like. The City shall secure and pay for easements shown on the plans unless otherwise specified.

The Contractor shall give all notices and comply with all laws, ordinances, rules and regulations bearing on the conduct of the work as drawn and specified. If the Contractor observes that the contract documents are at variance with those requirements, it shall promptly notify the Supervising Professional in writing, and any necessary changes shall be adjusted as provided in the Contract for changes in the work.

Section 10 - Protection of the Public and of Work and Property

The Contractor is responsible for the means, methods, sequences, techniques and procedures of construction and safety programs associated with the work contemplated by this contract. The Contractor, its agents or sub-contractors, shall comply with the "General Rules and Regulations for the Construction Industry" as published by the Construction Safety Commission of the State of Michigan and to all other local, State and National laws, ordinances, rules and regulations pertaining to safety of persons and property.

The Contractor shall take all necessary and reasonable precautions to protect the safety of the public. It shall continuously maintain adequate protection of all work from damage, and shall take all necessary and reasonable precautions to adequately protect all public and private property from injury or loss arising in connection with this Contract. It shall make good any damage, injury or loss to its work and to public and private property resulting from lack of reasonable protective precautions, except as may be due to errors in the contract documents, or caused by agents or employees of the City. The Contractor shall obtain and maintain sufficient insurance to cover damage to any City property at the site by any cause.

In an emergency affecting the safety of life, or the work, or of adjoining property, the Contractor is, without special instructions or authorization from the Supervising Professional, permitted to act at its discretion to prevent the threatened loss or injury. It shall also so act, without appeal, if authorized or instructed by the Supervising Professional.

Any compensation claimed by the Contractor for emergency work shall be determined by agreement or in accordance with the terms of Claims for Extra Cost - Section 15.

Section 11 - Inspection of Work

The City shall provide sufficient competent personnel for the inspection of the work.

The Supervising Professional shall at all times have access to the work whenever it is in preparation or progress, and the Contractor shall provide proper facilities for access and for inspection.

If the specifications, the Supervising Professional's instructions, laws, ordinances, or any public authority require any work to be specially tested or approved, the Contractor shall give the Supervising Professional timely notice of its readiness for inspection, and if the inspection is by an authority other than the Supervising Professional, of the date fixed for the inspection. Inspections by the Supervising Professional shall be made promptly, and where practicable at the source of supply. If any work should be covered up without approval or consent of the Supervising Professional, it must, if required by the Supervising Professional, be uncovered for examination and properly restored at the Contractor's expense.

Re-examination of any work may be ordered by the Supervising Professional, and, if so ordered, the work must be uncovered by the Contractor. If the work is found to be in accordance with the contract documents, the City shall pay the cost of re-examination and replacement. If the work is not in accordance with the contract documents, the Contractor shall pay the cost.

Section 12 - Superintendence

The Contractor shall keep on the work site, during its progress, a competent superintendent and any necessary assistants, all satisfactory to the Supervising Professional. The superintendent will be responsible to perform all on-site project management for the Contractor. The superintendent shall be experienced in the work required for this Contract. The superintendent shall represent the Contractor and all direction given to the superintendent shall be binding as if given to the Contractor. Important directions shall immediately be confirmed in writing to the Contractor. Other directions will be confirmed on written request. The Contractor shall give efficient superintendence to the work, using its best skill and attention.

Section 13 - Changes in the Work

The City may make changes to the quantities of work within the general scope of the Contract at any time by a written order and without notice to the sureties. If the changes add to or deduct from the extent of the work, the Contract Sum shall be adjusted accordingly. All the changes shall be executed under the conditions of the original Contract except that any claim for extension of time caused by the change shall be adjusted at the time of ordering the change.

In giving instructions, the Supervising Professional shall have authority to make minor changes in the work not involving extra cost and not inconsistent with the purposes of the work, but otherwise, except in an emergency endangering life or property, no extra work or change shall be made unless in pursuance of a written order by the Supervising Professional, and no claim for an addition to the Contract Sum shall be valid unless the additional work was ordered in writing.

The Contractor shall proceed with the work as changed and the value of the work shall be determined as provided in Claims for Extra Cost - Section 15.

Section 14 - Extension of Time

Extension of time stipulated in the Contract for completion of the work will be made if and as the Supervising Professional may deem proper under any of the following circumstances:

- (1) When work under an extra work order is added to the work under this Contract;
- (2) When the work is suspended as provided in Section 20;
- (3) When the work of the Contractor is delayed on account of conditions which could not have been foreseen, or which were beyond the control of the Contractor, and which were not the result of its fault or negligence;
- (4) Delays in the progress of the work caused by any act or neglect of the City or of its employees or by other Contractors employed by the City;
- (5) Delay due to an act of Government;
- (6) Delay by the Supervising Professional in the furnishing of plans and necessary information;
- (7) Other cause which in the opinion of the Supervising Professional entitles the Contractor to an extension of time.

The Contractor shall notify the Supervising Professional within 7 days of an occurrence or conditions which, in the Contractor's opinion, entitle it to an extension of time. The notice shall be in writing and submitted in ample time to permit full investigation and evaluation of the Contractor's claim. The Supervising Professional shall acknowledge receipt of the Contractor's notice within 7 days of its receipt. Failure to timely provide the written notice shall constitute a waiver by the Contractor of any claim.

In situations where an extension of time in contract completion is appropriate under this or any other section of the contract, the Contractor understands and agrees that the only available adjustment for events that cause any delays in contract completion shall be extension of the required time for contract completion and that there shall be no adjustments in the money due the Contractor on account of the delay.

Section 15 - Claims for Extra Cost

If the Contractor claims that any instructions by drawings or other media issued after the date of the Contract involved extra cost under this Contract, it shall give the Supervising Professional written notice within 7 days after the receipt of the instructions, and in any event before proceeding to execute the work, except in emergency endangering life or property. The procedure shall then be as provided for Changes in the Work-Section I3. No claim shall be valid unless so made.

If the Supervising Professional orders, in writing, the performance of any work not covered by the contract documents, and for which no item of work is provided in the Contract, and for which no unit price or lump sum basis can be agreed upon, then the extra work shall be done on a Cost-Plus-Percentage basis of payment as follows:

- (1) The Contractor shall be reimbursed for all reasonable costs incurred in doing the work, and shall receive an additional payment of 15% of all the reasonable costs to cover both its indirect overhead costs and profit;
- (2) The term "Cost" shall cover all payroll charges for employees and supervision required under the specific order, together with all worker's compensation, Social Security, pension and retirement allowances and social insurance, or other regular payroll charges on same; the cost of all material and supplies required of either temporary or permanent character; rental of all power-driven equipment at agreed upon rates, together with cost of fuel and supply charges for the equipment; and any costs incurred by the Contractor as a direct result of executing the order, if approved by the Supervising Professional;
- (3) If the extra is performed under subcontract, the subcontractor shall be allowed to compute its charges as described above. The Contractor shall be permitted to add an additional charge of 5% percent to that of the subcontractor for the Contractor's supervision and contractual responsibility;
- (4) The quantities and items of work done each day shall be submitted to the Supervising Professional in a satisfactory form on the succeeding day, and shall be approved by the Supervising Professional and the Contractor or adjusted at once;
- (5) Payments of all charges for work under this Section in any one month shall be made along with normal progress payments. Retainage shall be in accordance with Progress Payments-Section 16.

No additional compensation will be provided for additional equipment, materials, personnel, overtime or special charges required to perform the work within the time requirements of the Contract.

When extra work is required and no suitable price for machinery and equipment can be determined in accordance with this Section, the hourly rate paid shall be 1/40 of the basic weekly rate listed in the Rental Rate Blue Book published by Dataquest Incorporated and applicable to the time period the equipment was first used for the extra work. The hourly rate will be deemed to include all costs of operation such as bucket or blade, fuel, maintenance, "regional factors", insurance, taxes, and the like, but not the costs of the operator.

Section 16 - Progress Payments

The Contractor shall submit each month, or at longer intervals, if it so desires, an invoice covering work performed for which it believes payment, under the Contract terms, is due. The submission shall be to the City's Finance Department - Accounting Division. The Supervising Professional will, within 10 days following submission of the invoice, prepare a certificate for payment for the work in an amount to be determined by the Supervising Professional as fairly representing the acceptable work performed during the period covered by the Contractor's invoice. To insure the proper performance of this Contract, the City will retain a percentage of the estimate in accordance with Act 524, Public Acts of 1980. The City will then, following the receipt of the Supervising Professional's Certificate, make payment to the Contractor as soon as feasible, which is anticipated will be within 15 days.

An allowance may be made in progress payments if substantial quantities of permanent material have been delivered to the site but not incorporated in the completed work if the Contractor, in the opinion of the Supervising Professional, is diligently pursuing the work under this Contract. Such materials shall be properly stored and adequately protected. Allowance in the estimate shall be at the invoice price value of the items. Notwithstanding any payment of any allowance, all risk of loss due to vandalism or any damages to the stored materials remains with the Contractor.

In the case of Contracts which include only the Furnishing and Delivering of Equipment, the payments shall be; 60% of the Contract Sum upon the delivery of all equipment to be furnished, or in the case of delivery of a usable portion of the equipment in advance of the total equipment delivery, 60% of the estimated value of the portion of the equipment may be paid upon its delivery in advance of the time of the remainder of the equipment to be furnished; 30% of the Contract Sum upon completion of erection of all equipment furnished, but not later than 60 days after the date of delivery of all of the equipment to be furnished; and payment of the final 10% on final completion of erection, testing and acceptance of all the equipment to be furnished; but not later than 180 days after the date of delivery of all of the equipment to be furnished, unless testing has been completed and shows the equipment to be unacceptable.

With each invoice for periodic payment, the Contractor shall enclose a Contractor's Declaration - Section 43, and an updated project schedule per Order of Completion - Section 2.

Section 17 - Deductions for Uncorrected Work

If the Supervising Professional decides it is inexpedient to correct work that has been damaged or that was not done in accordance with the Contract, an equitable deduction from the Contract price shall be made.

Section 18 - Correction of Work Before Final Payment

The Contractor shall promptly remove from the premises all materials condemned by the Supervising Professional as failing to meet Contract requirements, whether incorporated in the work or not, and the Contractor shall promptly replace and re-execute the work in accordance with the Contract and without expense to the City and shall bear the expense of making good all work of other contractors destroyed or damaged by the removal or replacement.

If the Contractor does not remove the condemned work and materials within 10 days after written notice, the City may remove them and, if the removed material has value, may store the material

at the expense of the Contractor. If the Contractor does not pay the expense of the removal within 10 days thereafter, the City may, upon 10 days written notice, sell the removed materials at auction or private sale and shall pay to the Contractor the net proceeds, after deducting all costs and expenses that should have been borne by the Contractor. If the removed material has no value, the Contractor must pay the City the expenses for disposal within 10 days of invoice for the disposal costs.

The inspection or lack of inspection of any material or work pertaining to this Contract shall not relieve the Contractor of its obligation to fulfill this Contract and defective work shall be made good. Unsuitable materials may be rejected by the Supervising Professional notwithstanding that the work and materials have been previously overlooked by the Supervising Professional and accepted or estimated for payment or paid for. If the work or any part shall be found defective at any time before the final acceptance of the whole work, the Contractor shall forthwith make good the defect in a manner satisfactory to the Supervising Professional. The judgment and the decision of the Supervising Professional as to whether the materials supplied and the work done under this Contract comply with the requirements of the Contract shall be conclusive and final.

Section 19 - Acceptance and Final Payment

Upon receipt of written notice that the work is ready for final inspection and acceptance, the Supervising Professional will promptly make the inspection. When the Supervising Professional finds the work acceptable under the Contract and the Contract fully performed, the Supervising Professional will promptly sign and issue a final certificate stating that the work required by this Contract has been completed and is accepted by the City under the terms and conditions of the Contract. The entire balance found to be due the Contractor, including the retained percentage, shall be paid to the Contractor by the City within 30 days after the date of the final certificate.

Before issuance of final certificates, the Contractor shall file with the City:

- (1) The consent of the surety to payment of the final estimate;
- (2) The Contractor's Affidavit in the form required by Section 44.

In case the Affidavit or consent is not furnished, the City may retain out of any amount due the Contractor, sums sufficient to cover all lienable claims.

The making and acceptance of the final payment shall constitute a waiver of all claims by the City except those arising from:

- (1) unsettled liens;
- (2) faulty work appearing within 12 months after final payment;
- (3) hidden defects in meeting the requirements of the plans and specifications;
- (4) manufacturer's guarantees.

It shall also constitute a waiver of all claims by the Contractor, except those previously made and still unsettled.

Section 20 - Suspension of Work

The City may at any time suspend the work, or any part by giving 5 days' notice to the Contractor in writing. The work shall be resumed by the Contractor within 10 days after the date fixed in the

written notice from the City to the Contractor to do so. The City shall reimburse the Contractor for expense incurred by the Contractor in connection with the work under this Contract as a result of the suspension.

If the work, or any part, shall be stopped by the notice in writing, and if the City does not give notice in writing to the Contractor to resume work at a date within 90 days of the date fixed in the written notice to suspend, then the Contractor may abandon that portion of the work suspended and will be entitled to the estimates and payments for all work done on the portions abandoned, if any, plus 10% of the value of the work abandoned, to compensate for loss of overhead, plant expense, and anticipated profit.

Section 21 - Delays and the City's Right to Terminate Contract

If the Contractor refuses or fails to prosecute the work, or any separate part of it, with the diligence required to insure completion, ready for operation, within the allowable number of consecutive calendar days specified plus extensions, or fails to complete the work within the required time, the City may, by written notice to the Contractor, terminate its right to proceed with the work or any part of the work as to which there has been delay. After providing the notice the City may take over the work and prosecute it to completion, by contract or otherwise, and the Contractor and its sureties shall be liable to the City for any excess cost to the City. If the Contractor's right to proceed is terminated, the City may take possession of and utilize in completing the work, any materials, appliances and plant as may be on the site of the work and useful for completing the work. The right of the Contractor to proceed shall not be terminated or the Contractor charged with liquidated damages where an extension of time is granted under Extension of Time - Section 14.

If the Contractor is adjudged a bankrupt, or if it makes a general assignment for the benefit of creditors, or if a receiver is appointed on account of its insolvency, or if it persistently or repeatedly refuses or fails except in cases for which extension of time is provided, to supply enough properly skilled workers or proper materials, or if it fails to make prompt payments to subcontractors or for material or labor, or persistently disregards laws, ordinances or the instructions of the Supervising Professional, or otherwise is guilty of a substantial violation of any provision of the Contract, then the City, upon the certificate of the Supervising Professional that sufficient cause exists to justify such action, may, without prejudice to any other right or remedy and after giving the Contractor 3 days written notice, terminate this Contract. The City may then take possession of the premises and of all materials, tools and appliances thereon and without prejudice to any other remedy it may have, make good the deficiencies or finish the work by whatever method it may deem expedient, and deduct the cost from the payment due the Contractor. The Contractor shall not be entitled to receive any further payment until the work is finished. If the expense of finishing the work, including compensation for additional managerial and administrative services exceeds the unpaid balance of the Contract Sum, the Contractor and its surety are liable to the City for any excess cost incurred. The expense incurred by the City, and the damage incurred through the Contractor's default, shall be certified by the Supervising Professional.

Section 22 - Contractor's Right to Terminate Contract

If the work should be stopped under an order of any court, or other public authority, for a period of 3 months, through no act or fault of the Contractor or of anyone employed by it, then the Contractor may, upon 7 days written notice to the City, terminate this Contract and recover from the City payment for all acceptable work executed plus reasonable profit.

Section 23 - City's Right To Do Work

If the Contractor should neglect to prosecute the work properly or fail to perform any provision of this Contract, the City, 3 days after giving written notice to the Contractor and its surety may, without prejudice to any other remedy the City may have, make good the deficiencies and may deduct the cost from the payment due to the Contractor.

Section 24 - Removal of Equipment and Supplies

In case of termination of this Contract before completion, from any or no cause, the Contractor, if notified to do so by the City, shall promptly remove any part or all of its equipment and supplies from the property of the City, failing which the City shall have the right to remove the equipment and supplies at the expense of the Contractor.

The removed equipment and supplies may be stored by the City and, if all costs of removal and storage are not paid by the Contractor within 10 days of invoicing, the City upon 10 days written notice may sell the equipment and supplies at auction or private sale, and shall pay the Contractor the net proceeds after deducting all costs and expenses that should have been borne by the Contractor and after deducting all amounts claimed due by any lien holder of the equipment or supplies.

Section 25 - Responsibility for Work and Warranties

The Contractor assumes full responsibility for any and all materials and equipment used in the construction of the work and may not make claims against the City for damages to materials and equipment from any cause except negligence or willful act of the City. Until its final acceptance, the Contractor shall be responsible for damage to or destruction of the project (except for any part covered by Partial Completion and Acceptance - Section 26). The Contractor shall make good all work damaged or destroyed before acceptance. All risk of loss remains with the Contractor until final acceptance of the work (Section 19) or partial acceptance (Section 26). The Contractor is advised to investigate obtaining its own builders risk insurance.

The Contractor shall guarantee the quality of the work for a period of one year. The Contractor shall also unconditionally guarantee the quality of all equipment and materials that are furnished and installed under the contract for a period of one year. At the end of one year after the Contractor's receipt of final payment, the complete work, including equipment and materials furnished and installed under the contract, shall be inspected by the Contractor and the Supervising Professional. Any defects shall be corrected by the Contractor at its expense as soon as practicable but in all cases within 60 days. Any defects that are identified prior to the end of one year shall also be inspected by the Contractor and the Supervising Professional and shall be corrected by the Contractor at its expense as soon as practicable but in all cases within 60 days.

Surety Bonds shall remain in effect during the warranty and correction period in accordance with Section 29.

The Contractor shall assign all manufacturer or material supplier warranties to the City prior to final payment. The assignment shall not relieve the Contractor of its obligations under this paragraph to correct defects.

Section 26 - Partial Completion and Acceptance

If at any time prior to the issuance of the final certificate referred to in Acceptance and Final Payment - Section 19, any portion of the permanent construction has been satisfactorily completed, and if the Supervising Professional determines that portion of the permanent construction is not required for the operations of the Contractor but is needed by the City, the Supervising Professional shall issue to the Contractor a certificate of partial completion, and immediately the City may take over and use the portion of the permanent construction described in the certificate, and exclude the Contractor from that portion.

The issuance of a certificate of partial completion shall not constitute an extension of the Contractor's time to complete the portion of the permanent construction to which it relates if the Contractor has failed to complete it in accordance with the terms of this Contract. The issuance of the certificate shall not release the Contractor or its sureties from any obligations under this Contract including bonds.

If prior use increases the cost of, or delays the work, the Contractor shall be entitled to extra compensation, or extension of time, or both, as the Supervising Professional may determine.

Section 27 - Payments Withheld Prior to Final Acceptance of Work

The City may withhold or, on account of subsequently discovered evidence, nullify the whole or part of any certificate to the extent reasonably appropriate to protect the City from loss on account of:

- (1) Defective work not remedied;
- (2) Claims filed or reasonable evidence indicating probable filing of claims by other parties against the Contractor;
- (3) Failure of the Contractor to make payments properly to subcontractors or for material or labor;
- (4) Damage to another Contractor.

When the above grounds are removed or the Contractor provides a Surety Bond satisfactory to the City which will protect the City in the amount withheld, payment shall be made for amounts withheld under this section.

Section 28 - Contractor's Insurance

- (1) The Contractor shall procure and maintain during the life of this Contract, including the guarantee period and during any warranty work, such insurance policies, including those set forth below, as will protect itself and the City from all claims for bodily injuries, death or property damage that may arise under this Contract; whether the act(s) or omission(s) giving rise to the claim were made by the Contractor, any subcontractor, or anyone employed by them directly or indirectly. Prior to commencement of any work under this contract, Contractor shall provide to the City documentation satisfactory to the City, through City-approved means (currently myCOI), demonstrating it has obtained the required policies and endorsements. The certificates of insurance endorsements and/or copies of

policy language shall document that the Contractor satisfies the following minimum requirements. Contractor shall add registration@mycoitracking.com to its safe sender's list so that it will receive necessary communication from myCOI. When requested, Contractor shall provide the same documentation for its subcontractor(s) (if any).

Required insurance policies include:

- (a) Worker's Compensation Insurance in accordance with all applicable state and federal statutes. Further, Employers Liability Coverage shall be obtained in the following minimum amounts:

- Bodily Injury by Accident - \$500,000 each accident
 - Bodily Injury by Disease - \$500,000 each employee
 - Bodily Injury by Disease - \$500,000 each policy limit

- (b) Commercial General Liability Insurance equivalent to, as a minimum, Insurance Services Office form CG 00 01 04 13 or current equivalent. The City of Ann Arbor shall be named as an additional insured. There shall be no added exclusions or limiting endorsements specifically for the following coverages: Products and Completed Operations, Explosion, Collapse and Underground coverage or Pollution. Further there shall be no added exclusions or limiting endorsements that diminish the City's protections as an additional insured under the policy. The following minimum limits of liability are required:

- \$1,000,000 Each occurrence as respect Bodily Injury Liability or Property Damage Liability, or both combined.
 - \$2,000,000 Per Project General Aggregate
 - \$1,000,000 Personal and Advertising Injury
 - \$2,000,000 Products and Completed Operations Aggregate

- (c) Motor Vehicle Liability Insurance, including Michigan No-Fault Coverages, equivalent to, as a minimum, Insurance Services Office form CA 00 01 10 13 or current equivalent. Coverage shall include all owned vehicles, all non-owned vehicles and all hired vehicles. The City of Ann Arbor shall be named as an additional insured. There shall be no added exclusions or limiting endorsements that diminish the City's protections as an additional insured under the policy. Further, the limits of liability shall be \$1,000,000 for each occurrence as respects Bodily Injury Liability or Property Damage Liability, or both combined.

- (d) Umbrella/Excess Liability Insurance shall be provided to apply excess of the Commercial General Liability, Employers Liability and the Motor Vehicle coverage enumerated above, for each occurrence and for aggregate in the amount of \$1,000,000.

- (2) Insurance required under subsection (1)(b) and (1)(c) above shall be considered primary as respects any other valid or collectible insurance that the City may possess, including any self-insured retentions the City may have; and any other insurance the City does possess shall be considered excess insurance only and shall not be required to contribute with this insurance. Further, the Contractor agrees to waive any right of recovery by its insurer against the City for any insurance listed herein.

- (3) Insurance companies and policy forms are subject to approval of the City Attorney, which approval shall not be unreasonably withheld. Documentation must provide and demonstrate an unconditional and un-qualified 30-day written notice of cancellation in favor of the City of Ann Arbor. Further, the documentation must explicitly state the following: (a) the policy number(s); name of insurance company(s); name and address of the agent(s) or authorized representative(s); name(s), email address(es), and address of insured; project name; policy expiration date; and specific coverage amounts; (b) any deductibles or self-insured retentions which may be approved by the City, in its sole discretion; (c) that the policy conforms to the requirements specified Contractor shall furnish the City with satisfactory certificates of insurance and endorsements prior to commencement of any work. Upon request, the Contractor shall provide within 30 days a copy of the policy(ies) and all required endorsements to the City. If any of the above coverages expire by their terms during the term of this Contract, the Contractor shall deliver proof of renewal and/or new policies and endorsements to the Administering Service Area/Unit at least ten days prior to the expiration date.
- (4) Any Insurance provider of Contractor shall be authorized to do business in the State of Michigan and shall carry and maintain a minimum rating assigned by A.M. Best & Company's Key Rating Guide of "A-" Overall and a minimum Financial Size Category of "V". Insurance policies and certificates issued by non-authorized insurance companies are not acceptable unless approved in writing by the City.
- (5) City reserves the right to require additional coverage and/or coverage amounts as may be included from time to time in the Detailed Specifications for the Project.
- (6) The provisions of General Condition 28 shall survive the expiration or earlier termination of this contract for any reason.

Section 29 - Surety Bonds

Bonds will be required from the successful bidder as follows:

- (1) A Performance Bond to the City of Ann Arbor for the amount of the bid(s) accepted;
- (2) A Labor and Material Bond to the City of Ann Arbor for the amount of the bid(s) accepted.

The Contractor shall furnish bonds, each in an amount at least equal to the Contract Price, as security for the faithful performance and payment of all of Contractor's obligations under the Contract. The bonds shall remain in effect until one year after the date when final payment becomes due or until completion of the correction period specified herein, whichever is later, except as provided otherwise by Laws or Regulations or other provisions of the Contract.

Bonds shall be executed on forms supplied by the City in a manner and by a Surety Company authorized to transact business in Michigan and satisfactory to the City Attorney.

Section 30 - Damage Claims

The Contractor shall be held responsible for all damages to property of the City or others, caused by or resulting from the negligence of the Contractor, its employees, or agents during the progress of or connected with the prosecution of the work, whether within the limits of the work or elsewhere. The Contractor must restore all property injured including sidewalks, curbing, sodding, pipes, conduit, sewers or other public or private property to not less than its original condition with new work.

Section 31 - Refusal to Obey Instructions

If the Contractor refuses to obey the instructions of the Supervising Professional, the Supervising Professional shall withdraw inspection from the work, and no payments will be made for work performed thereafter nor may work be performed thereafter until the Supervising Professional shall have again authorized the work to proceed.

Instructions by Supervising Professional shall not absolve the Contractor of responsibility for the means, methods, sequences techniques or procedures of construction and associated safety programs in accordance with Section 10 of these General Conditions.”

Section 32 - Assignment

Neither party to the Contract shall assign the Contract without the written consent of the other. The Contractor may assign any monies due to it to a third party acceptable to the City.

Section 33 - Rights of Various Interests

Whenever work being done by the City's forces or by other contractors is contiguous to work covered by this Contract, the respective rights of the various interests involved shall be established by the Supervising Professional, to secure the completion of the various portions of the work in general harmony.

The Contractor is responsible to coordinate all aspects of the work, including coordination of, and with, utility companies and other contractors whose work impacts this project.

Section 34 - Subcontracts

The Contractor shall not award any work to any subcontractor without prior written approval of the City. The approval will not be given until the Contractor submits to the City a written statement concerning the proposed award to the subcontractor. The statement shall contain all information the City may require.

The Contractor shall be as fully responsible to the City for the acts and omissions of its subcontractors, and of persons either directly or indirectly employed by them, as it is for the acts and omissions of persons directly employed by it.

The Contractor shall cause appropriate provisions to be inserted in all subcontracts relative to the work to bind subcontractors to the Contractor by the terms of the General Conditions and all other contract documents applicable to the work of the subcontractors and to give the Contractor the

same power to terminate any subcontract that the City may exercise over the Contractor under any provision of the contract documents.

Nothing contained in the contract documents shall create any contractual relation between any subcontractor and the City.

Section 35 - Supervising Professional's Status

The Supervising Professional has the right to inspect any or all work. The Supervising Professional has authority to stop the work whenever stoppage may be appropriate to insure the proper execution of the Contract. The Supervising Professional has the authority to reject all work and materials which do not conform to the Contract and to decide questions which arise in the execution of the work.

Instructions by Supervising Professional shall not absolve the Contractor of responsibility for the means, methods, sequences techniques or procedures of construction and associated safety programs in accordance with Section 10 of these General Conditions.

The Supervising Professional shall make all measurements and determinations of quantities. Those measurements and determinations are final and conclusive between the parties.

Section 36 - Supervising Professional's Decisions

The Supervising Professional shall, within a reasonable time after their presentation to the Supervising Professional, make decisions in writing on all claims of the City or the Contractor and on all other matters relating to the execution and progress of the work or the interpretation of the contract documents.

Section 37 - Storing Materials and Supplies

Materials and supplies may be stored at the site of the work at locations agreeable to the City unless specific exception is listed elsewhere in these documents. Ample way for foot traffic and drainage must be provided, and gutters must, at all times, be kept free from obstruction. Traffic on streets shall be interfered with as little as possible. The Contractor may not enter or occupy with agents, employees, tools, or material any private property without first obtaining written permission from its owner. A copy of the permission shall be furnished to the Supervising Professional.

Section 38 - Lands for Work

The Contractor shall provide, at its own expense and without liability to the City, any additional land and access that may be required for temporary construction facilities or for storage of materials.

Section 39 - Cleaning Up

The Contractor shall, as directed by the Supervising Professional, remove at its own expense from the City's property and from all public and private property all temporary structures, rubbish and waste materials resulting from its operations unless otherwise specifically approved, in

writing, by the Supervising Professional.

Section 40 - Salvage

The Supervising Professional may designate for salvage any materials from existing structures or underground services. Materials so designated remain City property and shall be transported or stored at a location as the Supervising Professional may direct.

Section 41 - Night, Saturday or Sunday Work

No night or Sunday work (without prior written City approval) will be permitted except in the case of an emergency and then only to the extent absolutely necessary. The City may allow night work which, in the opinion of the Supervising Professional, can be satisfactorily performed at night. Night work is any work between 8:00 p.m. and 7:00 a.m. No Saturday work will be permitted unless the Contractor gives the Supervising Professional at least 48 hours but not more than 5 days' notice of the Contractor's intention to work the upcoming Saturday.

Section 42 - Sales Taxes

Under State law the City is exempt from the assessment of State Sales Tax on its direct purchases. Contractors who acquire materials, equipment, supplies, etc. for incorporation in City projects are not likewise exempt. State Law shall prevail. The Bidder shall familiarize itself with the State Law and prepare its Bid accordingly. No extra payment will be allowed under this Contract for failure of the Contractor to make proper allowance in this bid for taxes it must pay.

Section 43

CONTRACTOR'S DECLARATION

I hereby declare that I have not, during the period _____, 20___, to _____, 20___, performed any work, furnished any materials, sustained any loss, damage or delay, or otherwise done anything in addition to the regular items (or executed change orders) set forth in the Contract titled WWTP Clear Well Improvements, for which I shall ask, demand, sue for, or claim compensation or extension of time from the City, except as I hereby make claim for additional compensation or extension of time as set forth on the attached itemized statement. I further declare that I have paid all payroll obligations related to this Contract that have become due during the above period and that all invoices related to this Contract received more than 30 days prior to this declaration have been paid in full except as listed below.

There is/is not (Contractor please circle one and strike one as appropriate) an itemized statement attached regarding a request for additional compensation or extension of time.

Contractor

Date

By _____
(Signature)

Its _____
(Title of Office)

Past due invoices, if any, are listed below.

Section 44

CONTRACTOR'S AFFIDAVIT

The undersigned Contractor, _____, represents that on _____, 20____, it was awarded a contract by the City of Ann Arbor, Michigan to _____ under the terms and conditions of a Contract titled **WWTP Clear Well Improvements**. The Contractor represents that all work has now been accomplished and the Contract is complete.

The Contractor warrants and certifies that all of its indebtedness arising by reason of the Contract has been fully paid or satisfactorily secured; and that all claims from subcontractors and others for labor and material used in accomplishing the project, as well as all other claims arising from the performance of the Contract, have been fully paid or satisfactorily settled. The Contractor agrees that, if any claim should hereafter arise, it shall assume responsibility for it immediately upon request to do so by the City of Ann Arbor.

The Contractor, for valuable consideration received, does further waive, release and relinquish any and all claims or right of lien which the Contractor now has or may acquire upon the subject premises for labor and material used in the project owned by the City of Ann Arbor.

This affidavit is freely and voluntarily given with full knowledge of the facts.

Contractor

Date

By _____
(Signature)

Its _____
(Title of Office)

Subscribed and sworn to before me, on this _____ day of _____, 20____
_____, _____ County, Michigan

Notary Public
_____ County, MI
My commission expires on:

STANDARD SPECIFICATIONS

All work under this contract shall be performed in accordance with the Public Services Department Standard Specifications in effect at the date of availability of the contract documents stipulated in the Bid. All work under this Contract which is not included in these Standard Specifications, or which is performed using modifications to these Standard Specifications, shall be performed in accordance with the Detailed Specifications included in these contract documents.

Standard Specifications are available online:

<http://www.a2gov.org/departments/engineering/Pages/Engineering-and-Contractor-Resources.aspx>

DETAILED SPECIFICATIONS

SECTION 01 10 00 - SUMMARY

PART 1 - GENERAL

1.1 SUMMARY

A. Section Includes:

1. Project information.
2. Work covered by Contract Documents.
3. Access to site.
4. Coordination with occupants.
5. Work restrictions.
6. Suggested Sequence of Work.
7. Specification and drawing conventions.
8. Miscellaneous provisions.

B. Related Requirements:

1. Section 01 50 00 "Temporary Facilities and Controls" for limitations and procedures governing temporary use of Owner's facilities.

1.2 PROJECT INFORMATION

A. Project Identification: City of Ann Arbor WWTP Clear Well Improvements.

1. Project Location: 49 Old Dixboro Road, Ann Arbor, MI 48105.

B. Owner: City of Ann Arbor, 49 Old Dixboro Road, Ann Arbor, MI 48105.

1. Owner's Representative: Mr. Chris Englert, PE, Project Manager.

C. Engineer: OHM Advisors, 34000 Plymouth Road, Livonia, MI 48150. Phone Number: 734-522-6711.

1. Engineer's Representative: Ms. Jennifer Drinan, Project Manager, Phone Number: 734-466-4568.

1.3 WORK COVERED BY CONTRACT DOCUMENTS

A. The Work of Project is defined by the Contract Documents and consists of the following:

1. Demolition and modifications in and around the existing Filter Clear Wells including but not limited to:
 - a. Demolish existing masonry baffle walls and aeration equipment in the Filter Clear Wells.
 - b. Remove accumulated mud, filter media and similar debris from the Clear Wells.
 - c. Demolish existing steel air headers in the filter gallery.
 - d. Clean and paint existing piping in Clear Wells.
 - e. Patch and repair existing concrete surfaces.
 - f. Furnish and install new fine bubble aeration equipment and dissolved oxygen probes in the Clear Wells.
 - g. Program SCADA system to allow automated control of existing blower based upon DO.

B. Type of Contract.

1. Project will be constructed under a single prime contract.

1.4 SITE SAFETY CONDITIONS

A. The proposed work is at the City of Ann Arbor Wastewater Treatment Plant within below-grade tanks and/or structures or pipes that have been or are actively treating sanitary sewage. Given

the nature of the treatment process, conditions may be hazardous and can change continuously throughout the construction process.

- B. Contractor shall be responsible for identifying and instituting safety protocols conforming to all applicable OSHA, MIOSHA and City of Ann Arbor standards and implementing them for the duration of the Work.
- C. Safety protocols may include, but are not limited to confined space entry, monitoring and ventilation of confined spaces, lockout and tag-out procedures, open flame standards, and a general safe working environment.
- D. Contractor shall provide written documentation of proposed safety protocols for each area of Work including an emergency response plan when all hazardous or confined space work is being performed.
- E. Contractor to provide written documentation of COVID-19 Preparedness and Response Plan in accordance with MIOSHA guidance and requirements.

1.5 WORK BY OWNER

- A. General: Cooperate fully with Owner so work may be carried out smoothly, without interfering with operation of the Wastewater Treatment Plant processes or delaying work under this Contract or work by Owner. Coordinate the Work of this Contract with work performed by Owner.

1.6 ACCESS TO SITE

- A. General: Contractor shall have partial use of Project site for construction operations during construction period. Contractor's use of Project site is limited to the Tertiary Filter Building, and access/staging areas approved by Owner.
- B. Tertiary Filter Building: The WWTP Tertiary Filter Building is comprised of the North Filter Units and North Clear Well (#1, #3, #5, #7, #9 and #11) and the South Filter Units and South Clear Well (#2, #4, #6, #8, #10 and #12). The Clear Wells were originally constructed in 1977. One of these systems shall remain operational during the construction of the other system, unless approved by Owner and the State of Michigan Department of Environment, Great Lakes, and Energy.
- C. Use of Site: Limit use of Project site to the Filter Building and designated lay-down areas adjacent to it. Do not disturb portions of Project site beyond areas in which the Work is indicated.
 - 1. Driveways, Walkways and Entrances: Keep driveways loading areas, and entrances serving premises clear and available to Owner, Owner's employees, and emergency vehicles at all times. Do not use these areas for parking or storage of materials.
 - a. Schedule deliveries to minimize use of driveways and entrances by construction operations.
 - b. Schedule deliveries to minimize space and time requirements for storage of materials and equipment on-site.

1.7 COORDINATION WITH OCCUPANTS

- A. Full Owner Occupancy: Owner will occupy site and all buildings during entire construction period. Cooperate with Owner during construction operations to minimize conflicts and facilitate Owner usage. Perform the Work so as not to interfere with Owner's day-to-day operations. Maintain existing exits unless otherwise indicated.

1. Maintain access to existing walkways, corridors, and other adjacent occupied or used facilities. Do not close or obstruct walkways, corridors, or other occupied or used facilities without written permission from Owner and approval of authorities having jurisdiction.
2. Notify Owner not less than 72 hours in advance of activities that will affect Owner's operations.

1.8 WORK RESTRICTIONS

- A. Work Restrictions, General: Comply with restrictions on construction operations.
 1. Comply with limitations on use of public streets and with other requirements of authorities having jurisdiction.
- B. On-Site Work Hours: Limit work in the existing building to normal business working hours of 7:00 a.m. to 5:00 p.m., Monday through Friday, unless otherwise indicated. Longer hours may be considered upon request.
 1. Work at other times to avoid conflict with plant operations may be allowed with permission obtained at least 48 hours in advance.
- C. Owner's Restroom and Locker Facilities: These facilities are for the Owner's use only and Contractor will not have use of these amenities. Contractor shall provide onsite sanitary facilities during the construction period for own personnel.
- D. Noise, Vibration, and Odors: Coordinate operations that may result in high levels of noise and vibration, odors, or other disruption to Owner occupancy with Owner.
 1. Notify Engineer and Owner not less than two days in advance of proposed disruptive operations.
 2. Obtain Engineer and Owner's written permission before proceeding with disruptive operations.
- E. Existing Utility Interruptions: Do not interrupt utilities serving facilities occupied by Owner or others unless permitted under the following conditions and then only after providing temporary utility services according to requirements indicated:
- F. Controlled Substances: Use of tobacco products and other controlled substances on Project site is not permitted.
- G. Equipment Restrictions:
 1. Demolition will start on the North Clear Well, with the south filter units remaining in operation. The south system shall remain operational during the construction, unless approved by Owner and the State of Michigan Department of Environment, Great Lakes, and Energy.
 2. Upon completion and commissioning of the North Clear Well improvements, the Owner will return the north filter system to operations and take subsequently take the south filter system offline. The South Clear Well will be turned over to the Contractor for improvements.
 3. Contractor to provide 48-hours' notice to Engineer and Owner for shutdown of air line for demolition and tie in activities.

1.9 SUGGESTED SEQUENCE OF WORK

- A. In general, it is the intention and understanding that the Contractor shall have control over the sequence and order of execution of the Work to be done under the Contract and over the method(s) accomplishing the results. Engineer may make such reasonable requirements as

necessary for the proper and effective protection of work partially or wholly completed, and to these requirements, Contractor shall conform.

- B. Work may only be performed in one of the two Clear Wells at one time. All work must be complete, tested, inspected and accepted by Owner, and all construction materials, equipment and debris removed prior to beginning work in the other Clear Well.
- C. Operation of the tertiary filters is an essential process for the City and required for meeting the requirements of the NPDES permit. Any deviations from the proposed sequence below will require the Contractor to provide detailed information for the City of Ann Arbor to present the changes to the EGLE for their approval. Time associated with obtaining information, presenting to the EGLE and the EGLE's review is considered part of the Contract Time and may not be used to request a time extension or justify a delay.
- D. The work on the rehabilitation of the clear wells, cleaning, dewatering, demolition of the aeration piping and masonry baffle walls, installation of new aeration system, painting of piping and other ancillary items will be staged to maintain current operations using half of the existing equipment and automatic controls. The description below is based on taking the north clear well and six filters offline first. The south six filters could also be taken offline first if agreed upon by the Contractor, Owner and Engineer.
- E. A suggested sequence of Work is as follows:
 - 1. Prior to shutdown of the north clear well and associated six north filters for rehabilitation, the following items shall be completed:
 - a. Submittal and approval of the Contractor's construction schedule; clearly identifying the time needed for demolition and rehabilitation of the clear well.
 - b. Shop drawing submittal, approval and definitive date for the delivery of the aeration equipment for the north clear well.
 - c. Shop drawing submittal, approval and definitive date for the delivery for of the DO instrumentation.
 - d. Shop drawing submittal, approval and definitive date for the pressure relief valves, concrete repair materials, and the effluent weir extension plate.
 - 2. Upon completion of items in Step 1 above, the Contractor shall submit a request for shutdown of the north clear well. Isolation of the north filters will be performed by closing sluice gates to isolate the north clear well. In addition, butterfly valves will need to be closed to isolate the six north filters. The Owner will dewater the Clear Well to a level obtainable by the existing pumping equipment. Water will still be present in the Clear Well up to approximately four (4) inches. The Contractor shall complete dewatering of the Clear Well as needed for their confined space entry. Discharge of the dewatering operations to be coordinated with the Engineer and Owner. The Owner will allow dewatering discharge to re-enter the WWTP via the backwash tank on the south side of the Filter Building. Contractor shall continually dewater and/or control water within the Clear Well as necessary for their work for any leakage that occurs through the closed isolation valves and gates.
 - 3. Prior to and after the Clear Well has been dewatered, the Contractor is responsible to monitor the ground water elevation in monitoring wells MW1 and MW2. Contractor to immediately notify the Engineer and Owner if the ground water elevation exceeds 732.0. Ground water level above 732 may cause hydrostatic uplift damage to the bottom slab. Ground water elevation above 732 may require flooding of the clear well to prevent damage.
 - 4. Once the north Clear Well is taken offline, we recommend cleaning the walls, ceiling, and floors prior to commencing demolition in the clear well. The Owner shall allow use of plant effluent water for the cleaning operations. The washdown water may be pumped back into the WWTP through the backwash tank after screening for concrete, masonry and other debris. Upon completion of the improvements, the clear well shall be inspected for cleanliness before returning to operations.

5. One access way for each of the clear wells is available for modifications to increase the area for access as shown on the drawings. Modifications to the access ways is optional based on the Contractor's means and methods.
6. After isolation and cleaning, the Contractor shall commence with selective demolition in the north clear well. Demolition includes but is not limited to the following:
 - a. Removal and disposal of the aeration piping and stainless steel Sanitaire D24 diffusers.
 - b. Removal and disposal of the concrete masonry unit (CMU) baffle wall, CMU reinforcement, and patching of floor and ceiling interfaces.
 - c. Removal and disposal of the PVC chlorine solution piping and supports.
 - d. Removal and disposal of the clear well sample piping and supports.
7. After demolition, improvements shall commence including but not limited to:
 - a. Removal and replacement of the pressure relief valves in the floor slab of the clear well based on unit prices.
 - b. Sandblasting and coating of the existing piping exposed in the clear well.
 - c. Installation of the new aeration diffuser system including connection to the existing air piping in the Filter gallery.
 - d. Extensions to the effluent weir walls.
 - e. Repair of structural concrete cracks and spalled areas based on unit prices.
 - f. Patching of clear well walls at locations where the air piping was removed.
 - g. Installation of the Dissolved Oxygen (DO) monitoring instrumentation and connection to existing SCADA system.
 - h. Programming of the Owner's SCADA, HMI screens, and PLC for DO probes and blower automation.
8. Start up and commissioning of the north clear well requires the following systems to be inspected and approved for use by manufacturers' representatives, pressure tested and fully functioning:
 - a. North Clear Well shall be inspected prior to return to service to ensure it is free of debris, dust and materials that would obstruct the filter media nozzles.
 - b. Air piping, aeration system, and DO meter with connection to SCADA.
 - c. Revisions to the existing SCADA programming for the incorporation of the new DO probe.
9. After start-up and commissioning of the north clear well aeration system, the Owner will operate the aeration system for a minimum of two weeks. Any operational issues identified during the two-week test period shall be addressed and resolved immediately by the Contractor. If no issues affecting the operations are observed during the two-week operational test period, the Owner will allow the isolate of the remaining clear well for rehabilitation.
10. For the south clear well, the Contractor shall perform steps 2 through 9 above.
11. Clean up and demobilize.

1.10 SPECIFICATION AND DRAWING CONVENTIONS

- A. Specification Content: The Specifications use certain conventions for the style of language and the intended meaning of certain terms, words, and phrases when used in particular situations. These conventions are as follows:
 1. Imperative mood and streamlined language are generally used in the Specifications. The words "shall," "shall be," or "shall comply with," depending on the context, are implied where a colon (:) is used within a sentence or phrase.
 2. Specification requirements are to be performed by Contractor unless specifically stated otherwise.
- B. Division 01 General Requirements: Requirements of Sections in Division 01 apply to the Work of all Sections in the Specifications.

- C. Drawing Coordination: Requirements for materials and products identified on Drawings are described in detail in the Specifications. One or more of the following are used on Drawings to identify materials and products:
1. Terminology: Materials and products are identified by the typical generic terms used in the individual Specifications Sections.
 2. Abbreviations: Materials and products are identified by abbreviations published as part of the U.S. National CAD Standard and scheduled on Drawings.
 3. Keynoting: Materials and products are identified by reference keynotes referencing Specification Section numbers found in this Project Manual.

PART 2 - PRODUCTS (Not Used)

PART 3 - EXECUTION (Not Used)

END OF SECTION 01 10 00

SECTION 01 22 00 - UNIT PRICES

PART 1 - GENERAL

1.1 SUMMARY

- A. Section includes administrative and procedural requirements for unit prices.
- B. Related Requirements:
 - 1. Section 01 26 00 "Contract Modification Procedures" for procedures for submitting and handling Change Orders.
 - 2. Section 01 40 00 "Quality Requirements" for field testing by an independent testing agency.

1.2 DEFINITIONS

- A. Unit price is an amount incorporated into the Agreement, applicable during the duration of the Work as a price per unit of measurement for materials, equipment, or services, or a portion of the Work, added to or deducted from the Contract Sum by appropriate modification, if the scope of Work or estimated quantities of Work required by the Contract Documents are increased or decreased.

1.3 PROCEDURES

- A. Unit prices include all necessary material, plus cost for delivery, installation, insurance, applicable taxes, overhead, and profit.
- B. Owner reserves the right to reject Contractor's measurement of work-in-place that involves use of established unit prices and to have this work measured, at Owner's expense, by an independent surveyor acceptable to Contractor.
- C. List of Unit Prices: A schedule of unit prices is included in Part 3. Specification Sections referenced in the schedule contain requirements for materials described under each unit price.
- D. Payment for work under this contract will be based on a unit price or lump sum for work actually completed. Final measurements of the work will be taken by the Engineer to determine the amount of work done and thereby determine the total cost. The method of applying the unit prices to measured quantities will be as herein specified. Payment will include the cost of all labor, tools, materials, and equipment necessary to do the work.
- E. Several items may have been included in the bid form but may not be called for on the plans. These items have been included in order to establish a unit price in the event that the item of work is necessary. The Contractor should be aware that these items may increase, decrease, or be zero based on field conditions, or Owner direction.

1.4 INCIDENTAL ITEMS

- A. Any items of work indicated as incidental or included shall be considered as part of the project work and shall be completed at no additional expense to the Owner. Incidental or included items shall include labor, materials, and equipment that may not be specifically listed in the Bid Form or in the drawings or specifications, but which are necessary to complete the work.

1.5 PERMITS

A. A number of permits have been applied for by the Owner of this project. The Owner has acquired any known permits necessary for this project.

PART 2 - PRODUCTS (Not Used)

PART 3 - EXECUTION

3.1 SCHEDULE OF UNIT PRICES

3.2 CLEAR WELL IMPROVEMENTS (BID ITEM #1)

The completed work as measured for CLEAR WELL IMPROVEMENTS will be paid for at the contract lump sum for the following items (pay items):

<u>Pay Item</u>	<u>Pay Unit</u>
Clear Well Improvements	Lump Sum

The contract lump sum price shall be payment in full for all services, labor, materials, superintendence, equipment, tools, supplies, fuel, power, lighting, quality control, independent testing, dewatering, temporary ventilation and heating, cleaning, as necessary to perform the improvements and rehabilitation of the wastewater tertiary filter clear wells; dewatering and cleaning clear wells; demolition of existing masonry baffles walls, aeration equipment and appurtenances; and as necessary to furnish and install clear well aeration equipment, dissolved oxygen analyzer, SCADA programming, concrete modifications and accessories in compliance with the Contract Documents except for contract items listed separately below.

This shall include, but not be limited to:

1. Insurance and bonds.
2. Compliance with General Requirements.
3. Mobilization and demobilization, unless specified under a separate unit price.
4. Soil erosion control measures in compliance with applicable laws.
5. Permit requirements.
6. Traffic maintenance and control at the WWTP site (and as directed by the Engineer).
7. Confined space entry equipment; consisting of but not limited to lighting, ventilation, air quality monitoring.
8. Pressure washing equipment for tank cleaning.
9. Removal and disposal of debris from clear well following cleaning.
10. Structural concrete and maintenance of concrete work unless specified under a separate unit price.
11. Demolition, removal and disposal of existing baffle wall, aeration equipment and appurtenances noted for removal.
12. Cutting and patching associated with demolition and installation activities.
13. Structural concrete work unless specified under a separate unit price.
14. Field measurements and investigation of existing clear well tank.
15. Loading, transportation and unloading of all proposed equipment.
16. Provide proposed piping, equipment and appurtenances noted on drawings and specifications.
17. Electrical and instrumentation work.
18. SCADA and HMI programming.
19. Field preparation and coating of miscellaneous metal items.
20. Project restoration.
21. Monitoring of ground water elevation and removal of monitoring wells.
22. Equipment startup, training, and commissioning.
23. Site cleanup.
24. Record drawings of proposed equipment in AutoCAD format.

25. Project closeout.

Unit of measurement: Lump Sum based on schedule of values. Contractor shall submit a schedule of values for this work with major portions of the work group together in a logical manner (i.e., site work, demolition, cleaning, dewatering, concrete, masonry, mechanical, electrical, instrumentation, etc.). Submit the schedule of values to the Engineer at the pre-construction conference or no later than 21 days prior to the Initial Application for Payment. No payment requests shall be approved without an Engineer approved Schedule of Values. Amounts should be rounded to the nearest whole dollar, with the total equal to the unit price item. Provide a separate line item in the schedule of values for each part of the work where Applications for Payment may include materials or equipment purchased or fabricated and stored, but not yet installed. Provide separate line items in the schedule of values for initial cost of materials, for each subsequent stage of completion, and for total installed value of that part of the Work. Update and resubmit the schedule of values before the next Applications for Payment when Change Orders or Construction Change Directives result in a change in the unit price item.

3.3 REMOVE & REPLACE TYPE A PRESSURE RELIEF VALVES (BID ITEM #2)

The completed work as measured for REMOVE & REPLACE PRESSURE RELIEF VALVES will be paid for at the contract unit price for the following contract items (pay items):

<u>Pay Item</u>	<u>Pay Unit</u>
Remove & Replace Pressure Relief Valves	Each

Payment for Remove & Replace Pressure Relief Valves will be on the basis of the contract unit price per each.

The contract unit price shall be payment in full for all labor, materials and equipment necessary to remove and replace the existing pressure relief valves when repairs to the slab are completed. Payment for Remove and Replace Pressure Relief Valves shall include the following (except such items for which separate prices are received on the bid form): sawcutting and removal of the existing valves, well point dewatering at the PRVs, removal and replacement of the existing gravel drainage, 6-inch pressure relief valve, epoxy anchors, concrete disposal of removed material, salvage and reuse of existing rebar, placement of concrete, complete cleanup and surface restoration.

Remove and Replace Pressure Relief Valves shall only be paid for location where called for on the plans and as directed by the Engineer.

3.4 CONCRETE JOINT SEALER, REPAIR DETAIL R2 (BID ITEM #3)

The completed work as measured for CONCRETE JOINT SEALER will be paid for at the contract unit price for the following contract items (pay items):

<u>Pay Item</u>	<u>Pay Unit</u>
Concrete Joint Sealer, Repair Detail R2	Lineal Foot

Payment for Repair Detail R2 Concrete Joint Sealer will be on the basis of the contract unit price per lineal foot.

The contract unit price shall be payment in full for all labor, materials and equipment necessary to install joint sealer as called for on the plans and specifications. This includes but is not limited to product, installation equipment; control of water; removal of existing sealant; joint preparation and cleaning; removal of efflorescence present in the cracks and joints; application of primer; installation of backer rod, bond breaker tape and sealant; and cleaning of excess sealant materials from adjacent surfaces.

Concrete Joint Sealer shall only be paid for where called for on the plans and as directed by the Engineer.

3.5 URETHANE CRACK INJECTION REPAIR, REPAIR DETAIL R16 (BID ITEM #4)

The completed work as measured for EPOXY WALL REPAIR will be paid for at the contract unit price for the following contract items (pay items):

<u>Pay Item</u>	<u>Pay Unit</u>
Urethane Crack Injection Repair, Repair Detail 16	Lineal Foot

Payment for Repair Detail 16 Urethane Crack Injection Repair will be on the basis of the contract unit price per lineal foot.

The contract unit price shall be payment in full for all labor, materials and equipment necessary to install the Urethane Crack Injection Repair as called for on the plans and specifications.

The contract unit price shall be payment in full for all labor, materials and equipment necessary to install and inject the urethane as called for on the plans. This includes but is not limited to product, pumps and installation equipment, control of water, drilling/crack preparation and cleaning, removal of efflorescence present in the cracks, application of surface seal material to the face of the crack, installation, curing and removal of excess product and repair of sound concrete damaged by the chemical grout injection process.

Detail 16 Urethane Crack Injection Repair shall only be paid for where called for on the plans and as directed by the Engineer.

3.6 DELAMINATED CONCRETE REPAIR, REPAIR DETAIL R10 (BID ITEM #5)

The completed work as measured for DELAMINATED CONCRETE REPAIR will be paid for at the contract unit price for the following contract items (pay items):

<u>Pay Item</u>	<u>Pay Unit</u>
Delaminated Concrete Repair	Square Inches

Payment for Repair Detail R10 Delaminated Concrete Repair will be on the basis of the contract unit price per square inches.

The contract unit price shall be payment in full for all labor, materials and equipment necessary to install polymer-modified repair mortar on vertical, horizontal and overhead surfaces as called for on the plans. This includes but is not limited to identification and removal of unsound concrete, control of water, preparation of concrete surfaces and reinforcing steel, forming, mixing of products, patching of concrete surfaces, curing, finishing of formed surfaces, removal of excess product and cleaning.

Patching of concrete surfaces resulting from demolition and installation activities to be include in Bid Item 1.

Repair Detail R10 – Delaminated Concrete Repair shall only be paid for where called for on the plans or as directed by the Engineer.

END OF SECTION 01 22 00

SECTION 01 23 00 - ALTERNATES

PART 1 - GENERAL

1.1 SUMMARY

A. Section includes administrative and procedural requirements for alternates.

1.2 DEFINITIONS

A. Alternate: An amount proposed by bidders and stated on the Bid Form for certain work defined in the bidding requirements that may be added to or deducted from the base bid amount if Owner decides to accept a corresponding change either in the amount of construction to be completed or in the products, materials, equipment, systems, or installation methods described in the Contract Documents.

1. Alternates described in this Section are part of the Work only if enumerated in the Agreement.
2. The cost or credit for each alternate is the net addition to or deduction from the Contract Sum to incorporate alternate into the Work. No other adjustments are made to the Contract Sum.

1.3 PROCEDURES

A. Coordination: Revise or adjust affected adjacent work as necessary to completely integrate work of the alternate into Project.

1. Include as part of each alternate, miscellaneous devices, accessory objects, and similar items incidental to or required for a complete installation whether or not indicated as part of alternate.

B. Notification: Immediately following award of the Contract, notify each party involved, in writing, of the status of each alternate. Indicate if alternates have been accepted, rejected, or deferred for later consideration. Include a complete description of negotiated revisions to alternates.

C. Execute accepted alternates under the same conditions as other work of the Contract.

D. Schedule: A schedule of alternates is included at the end of this Section. Specification Sections referenced in schedule contain requirements for materials necessary to achieve the work described under each alternate.

PART 2 - PRODUCTS (Not Used)

PART 3 - EXECUTION

3.1 SCHEDULE OF ALTERNATES

A. Alternate No. 1: Limit Air Header Demolition in the Filter Gallery to limits identified on the drawings for Alternate No. 1.

1. Base Bid: Completely remove Air Headers in the Filter Gallery as shown on the drawings.
2. Alternate: Reduce extent of Air Header demolition to the limits identified on the drawings for Alternate No. 1.

END OF SECTION 01 23 00

SECTION 01 25 00 - SUBSTITUTION PROCEDURES

PART 1 - GENERAL

1.1 SUMMARY

- A. Section includes administrative and procedural requirements for substitutions.
- B. Related Requirements:
 - 1. Section 01 60 00 "Product Requirements" for requirements for submitting comparable product submittals for products by listed manufacturers.

1.2 DEFINITIONS

- A. Substitutions: Changes in products, materials, equipment, and methods of construction from those required by the Contract Documents and proposed by Contractor.

1.3 ACTION SUBMITTALS

- A. Substitution Requests: Submit three copies of each request for consideration. Identify product or fabrication or installation method to be replaced. Include Specification Section number and title and Drawing numbers and titles.
 - 1. Substitution Request Form: Use CSI Form 13.1A.
 - 2. Documentation: Show compliance with requirements for substitutions and the following, as applicable:
 - a. Statement indicating why specified product or fabrication or installation cannot be provided, if applicable.
 - b. Coordination information, including a list of changes or revisions needed to other parts of the Work and to construction performed by Owner and separate contractors that will be necessary to accommodate proposed substitution.
 - c. Detailed comparison of significant qualities of proposed substitution with those of the Work specified. Include annotated copy of applicable Specification Section. Significant qualities may include attributes such as performance, weight, size, durability, visual effect, sustainable design characteristics, warranties, and specific features and requirements indicated. Indicate deviations, if any, from the Work specified.
 - d. Product Data, including drawings and descriptions of products and fabrication and installation procedures.
 - e. Samples, where applicable or requested.
 - f. Certificates and qualification data, where applicable or requested.
 - g. List of similar installations for completed projects with project names and addresses and names and addresses of engineers and owners.
 - h. Material test reports from a qualified testing agency indicating and interpreting test results for compliance with requirements indicated.
 - i. Research reports evidencing compliance with building code in effect for Project.
 - j.
 - k. Detailed comparison of Contractor's construction schedule using proposed substitution with products specified for the Work, including effect on the overall Contract Time. If specified product or method of construction cannot be provided within the Contract Time, include letter from manufacturer, on manufacturer's letterhead, stating date of receipt of purchase order, lack of availability, or delays in delivery.
 - l. Cost information, including a proposal of change, if any, in the Contract Sum.
 - m. Contractor's certification that proposed substitution complies with requirements in the Contract Documents except as indicated in substitution request, is compatible with related materials, and is appropriate for applications indicated.

- n. Contractor's waiver of rights to additional payment or time that may subsequently become necessary because of failure of proposed substitution to produce indicated results.
- 3. Engineer's Action: If necessary, Engineer will request additional information or documentation for evaluation within ten days of receipt of a request for substitution. Engineer will notify Contractor of acceptance or rejection of proposed substitution within fifteen days of receipt of request, or seven days of receipt of additional information or documentation, whichever is later.
 - a. Forms of Acceptance: Change Order,, Work Change Directive or or Field Order.
 - b. Use product specified if Engineer does not issue a decision on use of a proposed substitution within time allocated.

1.4 QUALITY ASSURANCE

- A. Compatibility of Substitutions: Investigate and document compatibility of proposed substitution with related products and materials. Engage a qualified testing agency to perform compatibility tests recommended by manufacturers.

PART 2 - PRODUCTS

2.1 SUBSTITUTIONS

- A. Substitutions for Cause: Submit requests for substitution immediately on discovery of need for change, but not later than fifteen days prior to time required for preparation and review of related submittals.
 - 1. Conditions: Engineer will consider Contractor's request for substitution when the following conditions are satisfied:
 - a. Requested substitution is consistent with the Contract Documents and will produce indicated results.
 - b. Requested substitution will not adversely affect Contractor's construction schedule.
 - c. Requested substitution has received necessary approvals of authorities having jurisdiction.
 - d. Requested substitution is compatible with other portions of the Work.
 - e. Requested substitution has been coordinated with other portions of the Work.
 - f. Requested substitution provides specified warranty.
 - g. If requested substitution involves more than one contractor, requested substitution has been coordinated with other portions of the Work, is uniform and consistent, is compatible with other products, and is acceptable to all contractors involved.
- B. Substitutions for Convenience: Not allowed .
 - a. Requested substitution offers Owner a substantial advantage in cost, time, energy conservation, or other considerations, after deducting additional responsibilities Owner must assume. Owner's additional responsibilities may include compensation to Engineer for redesign and evaluation services, increased cost of other construction by Owner, and similar considerations.
 - b. Requested substitution does not require extensive revisions to the Contract Documents.
 - c. Requested substitution is consistent with the Contract Documents and will produce indicated results.
 - d. Requested substitution will not adversely affect Contractor's construction schedule.
 - e. Requested substitution has received necessary approvals of authorities having jurisdiction.
 - f. Requested substitution is compatible with other portions of the Work.
 - g. Requested substitution has been coordinated with other portions of the Work.
 - h. Requested substitution provides specified warranty.

- i. If requested substitution involves more than one contractor, requested substitution has been coordinated with other portions of the Work, is uniform and consistent, is compatible with other products, and is acceptable to all contractors involved.

PART 3 - EXECUTION (Not Used)

END OF SECTION 01 25 00

THIS PAGE INTENTIONALLY LEFT BLANK

SECTION 01 26 00 - CONTRACT MODIFICATION PROCEDURES

PART 1 - GENERAL

1.1 SUMMARY

- A. Section includes administrative and procedural requirements for handling and processing Contract modifications.

1.2 MINOR CHANGES IN THE WORK

- A. Engineer will issue Field Orders, authorizing changes in the Work, not involving adjustment to the Contract Sum or the Contract Time.

1.3 PROPOSAL REQUESTS

- A. Owner-Initiated Proposal Requests: Engineer will issue a detailed description of proposed changes in the Work that may require adjustment to the Contract Sum or the Contract Time. If necessary, the description will include supplemental or revised Drawings and Specifications.
 - 1. Work Change Proposal Requests issued by Engineer are not instructions either to stop work in progress or to execute the proposed change.
 - 2. Within 20 days, when not otherwise specified after receipt of Proposal Request, submit a quotation estimating cost adjustments to the Contract Sum and the Contract Time necessary to execute the change.
 - a. Include a list of quantities of products required or eliminated and unit costs, with total amount of purchases and credits to be made. If requested, furnish survey data to substantiate quantities.
 - b. Indicate applicable taxes, delivery charges, equipment rental, and amounts of trade discounts.
 - c. Include costs of labor and supervision directly attributable to the change.
 - d. Include an updated Contractor's construction schedule that indicates the effect of the change, including, but not limited to, changes in activity duration, start and finish times, and activity relationship. Use available total float before requesting an extension of the Contract Time.
 - e. Quotation Form: Use CSI Form 13.6D, "Proposal Worksheet Summary," and Form 13.6C, "Proposal Worksheet Detail." or forms acceptable to Engineer.
- B. Contractor-Initiated Work Change Proposals: If latent or changed conditions require modifications to the Contract, Contractor may initiate a claim by submitting a request for a change to Engineer.
 - 1. Include a statement outlining reasons for the change and the effect of the change on the Work. Provide a complete description of the proposed change. Indicate the effect of the proposed change on the Contract Sum and the Contract Time.
 - 2. Include a list of quantities of products required or eliminated and unit costs, with total amount of purchases and credits to be made. If requested, furnish survey data to substantiate quantities.
 - 3. Indicate applicable taxes, delivery charges, equipment rental, and amounts of trade discounts.
 - 4. Include costs of labor and supervision directly attributable to the change.
 - 5. Include an updated Contractor's construction schedule that indicates the effect of the change, including, but not limited to, changes in activity duration, start and finish times, and activity relationship. Use available total float before requesting an extension of the Contract Time.

6. Comply with requirements in Section 01 25 00 "Substitution Procedures" if the proposed change requires substitution of one product or system for product or system specified.
7. Work Change Proposal Request Form: Use CSI Form 13.6A, "Change Order Request (Proposal)," with attachments CSI Form 13.6D, "Proposal Worksheet Summary," and Form 13.6C, "Proposal Worksheet Detail." or a form acceptable to Engineer.

1.4 ADMINISTRATIVE CHANGE ORDERS

- A. Allowance Adjustment: See Section 01 21 00 "Allowances" for administrative procedures for preparation of Change Order Proposal for adjusting the Contract Sum to reflect actual costs of allowances.
- B. Unit-Price Adjustment: See Section 01 22 00 "Unit Prices" for administrative procedures for preparation of Change Order Proposal for adjusting the Contract Sum to reflect measured scope of unit-price work.

1.5 CHANGE ORDER PROCEDURES

- A. On Owner's approval of a Work Changes Proposal Request, Engineer will issue a Change Order for signatures of Owner and Contractor on a Change Order form provided by the Engineer.

1.6 WORK CHANGE DIRECTIVE

- A. Work Change Directive: Engineer may issue a Work Change Directive on EJCDC Document C-940. Work Change Directive instructs Contractor to proceed with a change in the Work, for subsequent inclusion in a Change Order.
 1. Work Change Directive contains a complete description of change in the Work. It also designates method to be followed to determine change in the Contract Sum or the Contract Time.
- B. Documentation: Maintain detailed records on a time and material basis of work required by the Work Change Directive.
 1. After completion of change, submit an itemized account and supporting data necessary to substantiate cost and time adjustments to the Contract.

PART 2 - PRODUCTS (Not Used)

PART 3 - EXECUTION (Not Used)

END OF SECTION 01 26 00

SECTION 01 29 00 - PAYMENT PROCEDURES

PART 1 - GENERAL

1.1 SUMMARY

- A. Section includes administrative and procedural requirements necessary to prepare and process Applications for Payment.
- B. Related Requirements:
 - 1. Section 01 22 00 "Unit Prices" for administrative requirements governing the use of unit prices.
 - 2. Section 01 26 00 "Contract Modification Procedures" for administrative procedures for handling changes to the Contract.
 - 3. Section 01 32 00 "Construction Progress Documentation" for administrative requirements governing the preparation and submittal of the Contractor's construction schedule.

1.2 SCHEDULE OF VALUES

- A. Coordination: Coordinate preparation of the schedule of values with preparation of Contractor's construction schedule.
 - 1. Coordinate line items in the schedule of values with other required administrative forms and schedules, including the following:
 - a. Application for Payment forms with continuation sheets.
 - b. Submittal schedule.
 - c. Items required to be indicated as separate activities in Contractor's construction schedule.
 - 2. Submit the schedule of values to Engineer at earliest possible date but no later than seven days before the date scheduled for submittal of initial Applications for Payment.
- B. Format and Content: Use Project Manual table of contents as a guide to establish line items for the schedule of values. Provide at least one line item for each Specification Section.
 - 1. Identification: Include the following Project identification on the schedule of values:
 - a. Project name and location.
 - b. Name of Engineer.
 - c. Engineer's project number.
 - d. Contractor's name and address.
 - e. Date of submittal.
 - 2. Arrange schedule of values consistent with format of EJCDC Document C-620.
 - 3. Provide a breakdown of the Contract Sum in enough detail to facilitate continued evaluation of Applications for Payment and progress reports. Coordinate with Project Manual table of contents. Provide multiple line items for principal subcontract amounts in excess of five percent of the Contract Sum.
 - a. Include separate line items under principal subcontracts for Project closeout requirements in an amount totaling five percent of the Contract Sum and subcontract amount.
 - 4. Round amounts to nearest whole dollar; total shall equal the Contract Sum.
 - 5. Provide a separate line item in the schedule of values for each part of the Work where Applications for Payment may include materials or equipment purchased or fabricated and stored, but not yet installed.
 - a. Differentiate between items stored on-site and items stored off-site. If specified, include evidence of insurance or bonded warehousing.
 - 6. Provide separate line items in the schedule of values for initial cost of materials, for each subsequent stage of completion, and for total installed value of that part of the Work.

7. Allowances: Provide a separate line item in the schedule of values for each allowance. Show line-item value of unit-cost allowances, as a product of the unit cost, multiplied by measured quantity. Use information indicated in the Contract Documents to determine quantities.
8. Each item in the schedule of values and Applications for Payment shall be complete. Include total cost and proportionate share of general overhead and profit for each item.
 - a. Temporary facilities and other major cost items that are not direct cost of actual work-in-place may be shown either as separate line items in the schedule of values or distributed as general overhead expense, at Contractor's option.
9. Schedule Updating: Update and resubmit the schedule of values before the next Applications for Payment when Change Orders or Construction Change Directives result in a change in the Contract Sum.

1.3 APPLICATIONS FOR PAYMENT

- A. Each Application for Payment shall be consistent with previous applications and payments as certified by Engineer and paid for by Owner.
 1. Initial Application for Payment, Application for Payment at time of Substantial Completion, and final Application for Payment involve additional requirements.
- B. Payment Application Times: Submit Application for Payment to Engineer by the day of the month agreed upon with the Owner. The period covered by each Application for Payment is one month, ending on the agreed upon day of month.
- C. Contractor's Declaration Form: Each application shall be accompanied by a Contractor's Declaration on the form provided in the project manual.
- D. Application for Payment Forms: Use EJCDC Document C-620 as form for Applications for Payment.
- E. Application Preparation: Complete every entry on form. Notarize and execute by a person authorized to sign legal documents on behalf of Contractor. Engineer will return incomplete applications without action.
 1. Entries shall match data on the schedule of values and Contractor's construction schedule. Use updated schedules if revisions were made.
 2. Include amounts of Change Orders, Work Change Directives and Construction Change Directives issued before last day of construction period covered by application.
- F. Transmittal: Submit three signed and notarized original copies of each Application for Payment to Engineer by a method ensuring receipt within 24 hours. One copy shall include waivers of lien and similar attachments if required.
 1. Transmit each copy with a transmittal form listing attachments and recording appropriate information about application.
- G. Waivers of Mechanic's Lien: With each Application for Payment, submit waivers of mechanic's lien from entities lawfully entitled to file a mechanic's lien arising out of the Contract and related to the Work covered by the payment.
 1. Submit partial waivers on each item for amount requested in previous application, after deduction for retainage, on each item.
 2. When an application shows completion of an item, submit conditional final or full waivers.
 3. Owner reserves the right to designate which entities involved in the Work must submit waivers.
 4. Waiver Forms: Submit executed waivers of lien on forms acceptable to Owner.
 5. Submit final application for payment with or preceded by final waivers from every entity involved with performance of the Work covered by the application who is lawfully entitled to a lien.

- H. Initial Application for Payment: Administrative actions and submittals that must precede or coincide with submittal of first Application for Payment include the following:
1. List of subcontractors.
 2. Schedule of values.
 3. Contractor's construction schedule (preliminary if not final).
 4. Schedule of unit prices.
 5. Submittal schedule (preliminary if not final).
 6. List of Contractor's staff assignments.
 7. List of Contractor's principal consultants.
 8. Copies of building permits.
 9. Copies of authorizations and licenses from authorities having jurisdiction for performance of the Work.
 10. Initial progress report.
 11. Report of preconstruction conference.
 12. Certificates of insurance and insurance policies.
- I. Application for Payment at Substantial Completion: After Engineer issues the Certificate of Substantial Completion, submit an Application for Payment showing 100 percent completion for portion of the Work claimed as substantially complete.
1. Include documentation supporting claim that the Work is substantially complete and a statement showing an accounting of changes to the Contract Sum.
 2. This application shall reflect Certificates of Partial Substantial Completion issued previously for Owner occupancy of designated portions of the Work.
- J. Final Payment Application: After completing Project closeout requirements, submit final Application for Payment with releases and supporting documentation not previously submitted and accepted, including, but not limited, to the following:
1. Evidence of completion of Project closeout requirements.
 2. Insurance certificates for products and completed operations where required and proof that taxes, fees, and similar obligations were paid.
 3. Updated final statement, accounting for final changes to the Contract Sum.
 4. AIA Document G706-1994, "Contractor's Affidavit of Payment of Debts and Claims."
 5. AIA Document G706A-1994, "Contractor's Affidavit of Release of Liens."
 6. AIA Document G707-1994, "Consent of Surety to Final Payment."
 7. Evidence that claims have been settled.
 8. Final meter readings for utilities, a measured record of stored fuel, and similar data as of date of Substantial Completion or when Owner took possession of and assumed responsibility for corresponding elements of the Work.
 9. Final liquidated damages settlement statement.
 10. Releases from the public agencies from which permits have been obtained for Work under this agreement.

PART 2 - PRODUCTS (Not Used)

PART 3 - EXECUTION (Not Used)

END OF SECTION 01 29 00

SECTION 01 31 00 - PROJECT MANAGEMENT AND COORDINATION

PART 1 - GENERAL

1.1 SUMMARY

- A. Section includes administrative provisions for coordinating construction operations on Project including, but not limited to, the following:
 - 1. Coordination drawings.
 - 2. Requests for Information (RFIs).
 - 3. Project meetings.
- B. Related Requirements:
 - 1. Section 01 73 00 "Execution" for procedures for coordinating general installation and field-engineering services, including establishment of benchmarks and control points.

1.2 DEFINITIONS

- A. RFI: Request from Contractor seeking information required by or clarifications of the Contract Documents.

1.3 INFORMATIONAL SUBMITTALS

- A. Subcontract List: Prepare a written summary identifying individuals or firms proposed for each portion of the Work, including those who are to furnish products or equipment fabricated to a special design with 24 hours of receipt of bids. Use CSI Form 1.5A or similar. Include the following information in tabular form:
 - 1. Name, address, and telephone number of entities performing subcontract or supplying products.
 - 2. Number and title of related Specification Section(s) covered by subcontract.
 - 3. Drawing number and detail references, as appropriate, covered by subcontract.

1.4 GENERAL COORDINATION PROCEDURES

- A. Coordination: Coordinate construction operations included in different Sections of the Specifications to ensure efficient and orderly installation of each part of the Work. Coordinate construction operations, included in different Sections that depend on each other for proper installation, connection, and operation.
 - 1. Schedule construction operations in sequence required to obtain the best results where installation of one part of the Work depends on installation of other components, before or after its own installation.
 - 2. Coordinate installation of different components to ensure maximum performance and accessibility for required maintenance, service, and repair.
 - 3. Make adequate provisions to accommodate items scheduled for later installation.
- B. Prepare memoranda for distribution to each party involved, outlining special procedures required for coordination. Include such items as required notices, reports, and list of attendees at meetings.
 - 1. Prepare similar memoranda for Owner and separate contractors if coordination of their Work is required.
- C. Administrative Procedures: Coordinate scheduling and timing of required administrative procedures with other construction activities and activities of other contractors to avoid conflicts

and to ensure orderly progress of the Work. Such administrative activities include, but are not limited to, the following:

1. Preparation of Contractor's construction schedule.
2. Preparation of the schedule of values.
3. Installation and removal of temporary facilities and controls.
4. Delivery and processing of submittals.
5. Progress meetings.
6. Preinstallation conferences.
7. Project closeout activities.
8. Startup and adjustment of systems.

- D. Coordination with Owner and other contractors: The Owner, utility companies, and commercial or private owners may have construction projects occurring within or adjacent to the project limits during the life of this contract. Coordinate construction with all such projects that may be ongoing in the vicinity. Where the Contractor's work affects the operation of the Owner's utilities, coordinate work with the Owner. Contact Owner's representative. Give at least 48 hours of notice to the Owner in order to schedule activities such as valve operation, hydrant operation, sewer and structure cleanout, and similar items of work. No claim for extra compensation or adjustments in the contract prices will be allowed on account of delay or failure of others to complete the work scheduled.

1.5 COORDINATION DRAWINGS

- A. Coordination Drawings, General: Prepare coordination drawings according to requirements in individual Sections, where installation is not completely shown on Shop Drawings, where limited space availability necessitates coordination, or if coordination is required to facilitate integration of products and materials fabricated or installed by more than one entity.
1. Content: Project-specific information, drawn accurately to a scale large enough to indicate and resolve conflicts. Do not base coordination drawings on standard printed data. Include the following information, as applicable:
 - a. Indicate functional and spatial relationships of components of architectural, structural, civil, mechanical, and electrical systems.
 - b. Indicate dimensions shown on the Drawings. Specifically note dimensions that appear to be in conflict with submitted equipment and minimum clearance requirements. Provide alternate sketches to Engineer indicating proposed resolution of such conflicts. Minor dimension changes and difficult installations will not be considered changes to the Contract.
- B. Coordination Drawing Organization: Organize coordination drawings as follows:
1. Floor Plans and Reflected Ceiling Plans: Show architectural and structural elements, and mechanical, plumbing, fire-protection, fire-alarm, and electrical Work. Show locations of visible ceiling-mounted devices relative to acoustical ceiling grid.
 2. Plenum Space: Indicate subframing for support of ceiling and wall systems, mechanical and electrical equipment, and related Work. Locate components within ceiling plenum to accommodate layout of light fixtures indicated on Drawings.
 3. Mechanical Rooms: Provide coordination drawings for mechanical rooms showing plans and elevations of mechanical, plumbing, fire-protection, fire-alarm, and electrical equipment.
 4. Structural Penetrations: Indicate penetrations and openings required for all disciplines.
 5. Slab Edge and Embedded Items: Indicate slab edge locations and sizes and locations of embedded items for metal fabrications, sleeves, anchor bolts, bearing plates, angles, door floor closers, slab depressions for floor finishes, curbs and housekeeping pads, and similar items.
 6. Review: Engineer will review coordination drawings to confirm that the Work is being coordinated, but not for the details of the coordination, which are Contractor's responsibility.

1.6 REQUESTS FOR INFORMATION (RFIs)

- A. General: Immediately on discovery of the need for additional information or interpretation of the Contract Documents, Contractor shall prepare and submit an RFI in the form specified.
1. Engineer will return RFIs submitted to Engineer by other entities controlled by Contractor with no response.
 2. Coordinate and submit RFIs in a prompt manner so as to avoid delays in Contractor's work or work of subcontractors.
- B. Content of the RFI: Include a detailed, legible description of item needing information or interpretation and the following:
1. Project name.
 2. Project number.
 3. Date.
 4. Name of Contractor.
 5. Name of Engineer
 6. RFI number, numbered sequentially.
 7. RFI subject.
 8. Specification Section number and title and related paragraphs, as appropriate.
 9. Drawing number and detail references, as appropriate.
 10. Field dimensions and conditions, as appropriate.
 11. Contractor's suggested resolution. If Contractor's solution(s) impacts the Contract Time or the Contract Sum, Contractor shall state impact in the RFI.
 12. Contractor's signature.
 13. Attachments: Include sketches, descriptions, measurements, photos, Product Data, Shop Drawings, coordination drawings, and other information necessary to fully describe items needing interpretation.
 14. Space for Engineer's response.
- C. RFI Forms: AIA Document G716 or soft-ware generated form with substantially the same content as indicated above, acceptable to Engineer.
- D. Engineer's Action: Engineer will review each RFI, determine action required, and respond. Allow seven working days for Engineer's response for each RFI. RFIs received by Engineer after 1:00 p.m. will be considered as received the following working day.
1. The following RFIs will be returned without action:
 - a. Requests for approval of submittals.
 - b. Requests for approval of substitutions.
 - c. Requests for coordination information already indicated in the Contract Documents.
 - d. Requests for adjustments in the Contract Time or the Contract Sum.
 - e. Requests for interpretation of Engineer's actions on submittals.
 - f. Incomplete RFIs or inaccurately prepared RFIs.
 2. Engineer's action may include a request for additional information, in which case Engineer's time for response will date from time of receipt of additional information.
 3. Engineer's action on RFIs that may result in a change to the Contract Time or the Contract Sum may be eligible for Contractor to submit Change Proposal according to Section 01 26 00 "Contract Modification Procedures."
 - a. If Contractor believes the RFI response warrants change in the Contract Time or the Contract Sum, notify Engineer in writing within 10 days of receipt of the RFI response.
- E. RFI Log: Prepare, maintain, and submit a tabular log of RFIs organized by the RFI number. Submit log at each construction progress meeting. Use CSI Log Form 13.2B or similar form. Include the following:
1. Project name.
 2. Name and address of Contractor.
 3. Name and address of Engineer.

4. RFI number including RFIs that were dropped and not submitted.
5. RFI description.
6. Date the RFI was submitted.
7. Date Engineer's response was received.

F. On receipt of Engineer's action, update the RFI log and immediately distribute the RFI response to affected parties. Review response and notify Engineer's within seven days if Contractor disagrees with response.

1. Identification of related Field Order, Work Change Directive, and Proposal Request, as appropriate.

1.7 PROJECT MEETINGS

A. General: Schedule and conduct meetings and conferences at Project site unless otherwise indicated.

1. Attendees: Inform participants and others involved, and individuals whose presence is required, of date and time of each meeting. Notify Owner and Engineer of scheduled meeting dates and times.
2. Agenda: Prepare the meeting agenda. Distribute the agenda to all invited attendees.
3. Minutes: record significant discussions and agreements achieved. Distribute the meeting minutes to everyone concerned, including Owner and Engineer, within three days of the meeting.

B. Preconstruction Conference: Schedule and conduct a preconstruction conference before starting construction, at a time convenient to Owner and Engineer, but no later than 15 days after execution of the Agreement.

1. Attendees: Authorized representatives of Owner, Engineer, and their consultants; Contractor and its superintendent; major subcontractors; suppliers; and other concerned parties shall attend the conference. Participants at the conference shall be familiar with Project and authorized to conclude matters relating to the Work.
2. Agenda: Discuss items of significance that could affect progress, including the following:
 - a. Tentative construction schedule.
 - b. Phasing.
 - c. Critical work sequencing and long-lead items.
 - d. Designation of key personnel and their duties.
 - e. Procedures for processing field decisions and Change Orders.
 - f. Procedures for RFIs.
 - g. Procedures for testing and inspecting.
 - h. Procedures for processing Applications for Payment.
 - i. Distribution of the Contract Documents.
 - j. Submittal procedures.
 - k. Preparation of record documents.
 - l. Use of the premises
 - m. Use of existing building if Contractor will need access to a building.
 - n. Work restrictions.
 - o. Working hours.
 - p. Owner's occupancy requirements.
 - q. Responsibility for temporary facilities and controls.
 - r. Procedures for disruptions and shutdowns.
 - s. Construction waste management and recycling.
 - t. Parking availability.
 - u. Office, work, and storage areas.
 - v. Equipment deliveries and priorities.
 - w. First aid.
 - x. Security.
 - y. Progress cleaning.

3. Minutes: Entity responsible for conducting meeting will record and distribute meeting minutes.
- C. Preinstallation Conferences: Conduct a preinstallation conference at Project site before each construction activity that requires coordination with other construction.
1. Attendees: Installer and representatives of manufacturers and fabricators involved in or affected by the installation and its coordination or integration with other materials and installations that have preceded or will follow, shall attend the meeting. Advise Engineer of scheduled meeting dates.
 2. Agenda: Review progress of other construction activities and preparations for the particular activity under consideration, including requirements for the following:
 - a. Contract Documents.
 - b. Options.
 - c. Related RFIs.
 - d. Related Change Orders.
 - e. Purchases.
 - f. Deliveries.
 - g. Submittals.
 - h. Possible conflicts.
 - i. Compatibility problems.
 - j. Time schedules.
 - k. Weather limitations.
 - l. Manufacturer's written instructions.
 - m. Warranty requirements.
 - n. Compatibility of materials.
 - o. Acceptability of substrates.
 - p. Temporary facilities and controls.
 - q. Space and access limitations.
 - r. Regulations of authorities having jurisdiction.
 - s. Testing and inspecting requirements.
 - t. Installation procedures.
 - u. Coordination with other work.
 - v. Required performance results.
 - w. Protection of adjacent work.
 - x. Protection of construction and personnel.
 3. Record significant conference discussions, agreements, and disagreements, including required corrective measures and actions.
 4. Reporting: Distribute minutes of the meeting to each party present and to other parties requiring information.
 5. Do not proceed with installation if the conference cannot be successfully concluded. Initiate whatever actions are necessary to resolve impediments to performance of the Work and reconvene the conference at earliest feasible date.
- D. Progress Meetings: Conduct progress meetings at monthly intervals.
1. Attendees: In addition to representatives of Owner and Engineer, each contractor, subcontractor, supplier, and other entity concerned with current progress or involved in planning, coordination, or performance of future activities shall be represented at these meetings. All participants at the meeting shall be familiar with Project and authorized to conclude matters relating to the Work.
 2. Agenda: Review and correct or approve minutes of previous progress meeting. Review other items of significance that could affect progress. Include topics for discussion as appropriate to status of Project.
 - a. Contractor's Construction Schedule: Review progress since the last meeting. Determine whether each activity is on time, ahead of schedule, or behind schedule, in relation to Contractor's construction schedule. Determine how construction behind schedule will be expedited; secure commitments from parties involved to do so. Discuss whether

schedule revisions are required to ensure that current and subsequent activities will be completed within the Contract Time.

- 1) Review schedule for next period.
- b. Review present and future needs of each entity present, including the following:
 - 1) Interface requirements.
 - 2) Sequence of operations.
 - 3) Status of submittals.
 - 4) Deliveries.
 - 5) Off-site fabrication.
 - 6) Access.
 - 7) Site utilization.
 - 8) Temporary facilities and controls.
 - 9) Progress cleaning.
 - 10) Quality and work standards.
 - 11) Status of correction of deficient items.
 - 12) Field observations.
 - 13) Status of RFIs.
 - 14) Status of proposal requests.
 - 15) Pending changes.
 - 16) Status of Change Orders.
 - 17) Pending claims and disputes.
 - 18) Documentation of information for payment requests.
3. Minutes: Entity responsible for conducting the meeting will record and distribute the meeting minutes to each party present and to parties requiring information.
 - a. Schedule Updating: Revise Contractor's construction schedule after each progress meeting where revisions to the schedule have been made or recognized. Issue revised schedule concurrently with the report of each meeting.

PART 2 - PRODUCTS (Not Used)

PART 3 - EXECUTION (Not Used)

END OF SECTION 01 31 00

SECTION 01 32 00 - CONSTRUCTION PROGRESS DOCUMENTATION

PART 1 - GENERAL

1.1 SUMMARY

- A. Section includes administrative and procedural requirements for documenting the progress of construction during performance of the Work, including the following:
 - 1. Contractor's construction schedule.
 - 2. Construction schedule updating reports.
 - 3. Daily construction reports.
 - 4. Site condition reports.
- B. Related Requirements:
 - 1. Section 01 32 33 "Photographic Documentation."
 - 2. Section 01 10 00 "Summary" for preparing a combined Contractor's construction schedule.

1.2 DEFINITIONS

- A. Activity: A discrete part of a project that can be identified for planning, scheduling, monitoring, and controlling the construction project. Activities included in a construction schedule consume time and resources.
 - 1. Critical Activity: An activity on the critical path that must start and finish on the planned early start and finish times.
 - 2. Predecessor Activity: An activity that precedes another activity in the network.
 - 3. Successor Activity: An activity that follows another activity in the network.
- B. CPM: Critical path method, which is a method of planning and scheduling a construction project where activities are arranged based on activity relationships. Network calculations determine when activities can be performed and the critical path of Project.
- C. Critical Path: The longest connected chain of interdependent activities through the network schedule that establishes the minimum overall Project duration and contains no float.
- D. Float: The measure of leeway in starting and completing an activity.
 - 1. Float time is not for the exclusive use or benefit of either Owner or Contractor, but is a jointly owned, expiring Project resource available to both parties as needed to meet schedule milestones and Contract completion date.

1.3 INFORMATIONAL SUBMITTALS

- A. Format for Submittals: Submit required submittals in the following format:
 - 1. Working electronic copy of schedule file, where indicated.
 - 2. PDF electronic file.
- B. Startup Network Diagram: Of size required to display entire network for entire construction period. Show logic ties for activities.
- C. Contractor's Construction Schedule: Initial schedule, of size required to display entire schedule for entire construction period.
 - 1. Submit a working electronic copy of schedule, using software indicated, and labeled to comply with requirements for submittals. Include type of schedule (initial or updated) and date on label.

- D. Construction Schedule Updating Reports: Submit with Applications for Payment.
- E. Daily Construction Reports: Submit at weekly intervals.
- F. Site Condition Reports: Submit at time of discovery of differing conditions.

1.4 COORDINATION

- A. Coordinate Contractor's construction schedule with the schedule of values, list of subcontracts, submittal schedule, progress reports, payment requests, and other required schedules and reports.
 - 1. Secure time commitments for performing critical elements of the Work from entities involved.
 - 2. Coordinate each construction activity in the network with other activities and schedule them in proper sequence.

PART 2 - PRODUCTS

2.1 CONTRACTOR'S CONSTRUCTION SCHEDULE, GENERAL

- A. Time Frame: Extend schedule from date established for the Notice to Proceed to date of final completion.
 - 1. Contract completion date shall not be changed by submission of a schedule that shows an early completion date, unless specifically authorized by Change Order.
- B. Activities: Treat each story or separate area as a separate numbered activity for each main element of the Work.
 - 1. Activity Duration: Define activities so no activity is longer than 20 days, unless specifically allowed by Engineer.
 - 2. Procurement Activities: Include procurement process activities for the following long lead items and major items, requiring a cycle of more than 60 days, as separate activities in schedule. Procurement cycle activities include, but are not limited to, submittals, approvals, purchasing, fabrication, and delivery.
 - a. Air Diffusion Equipment.
 - 3. Submittal Review Time: Include review and resubmittal times indicated in Section 01 33 00 "Submittal Procedures" in schedule. Coordinate submittal review times in Contractor's construction schedule with submittal schedule.
 - 4. Startup and Testing Time: Include no fewer than 15 days for startup and testing.
 - 5. Substantial Completion: Indicate completion in advance of date established for Substantial Completion and allow time for Engineer administrative procedures necessary for certification of Substantial Completion.
 - 6. Punch List and Final Completion: Include not more than 30 days for completion of punch list items and final completion.
- C. Constraints: Include constraints and work restrictions indicated in the Contract Documents and as follows in schedule and show how the sequence of the Work is affected.
 - 1. Work Restrictions: Show the effect of the following items on the schedule:
 - a. Coordination with existing construction.
 - b. Limitations of continued occupancies.
 - c. Uninterruptible services.
 - d. Partial occupancy before Substantial Completion.
 - e. Use of premises restrictions.
 - f. Provisions for future construction.
 - g. Seasonal variations.

- h. Environmental control.
 - 2. Work Stages: Indicate important stages of construction for each major portion of the Work. Separate the schedule into the north and south clear well activities.
 - 3. Other Constraints:
- D. Milestones: Include milestones indicated in the Contract Documents in schedule, including, but not limited to, the Notice to Proceed, Substantial Completion, and final completion,
- E. Upcoming Work Summary: Prepare summary report indicating activities scheduled to occur or commence prior to submittal of next schedule update. Summarize the following issues:
- 1. Unresolved issues.
 - 2. Unanswered Requests for Information.
 - 3. Rejected or unreturned submittals.
 - 4. Notations on returned submittals.
 - 5. Pending modifications affecting the Work and Contract Time.
- F. Recovery Schedule: When periodic update indicates the Work is 14 or more calendar days behind the current approved schedule, submit a separate recovery schedule indicating means by which Contractor intends to regain compliance with the schedule.
- G. Computer Scheduling Software: Prepare schedules using current version of a program that has been developed specifically to manage construction schedules.

2.2 CONTRACTOR'S CONSTRUCTION SCHEDULE (CPM SCHEDULE)

- A. General: Prepare network diagrams using AON (activity-on-node) format.
- B. Startup Network Diagram: Submit final diagram within 14 days of date established for preconstruction conference. Outline significant construction activities for the first 90 days of construction. Include skeleton diagram for the remainder of the Work and a cash requirement prediction based on indicated activities.
- C. CPM Schedule: Prepare Contractor's construction schedule using a time-scaled CPM network analysis diagram for the Work.
- 1. Develop network diagram in sufficient time to submit CPM schedule so it can be accepted for use no later than 60 days after date established for the Notice of Award.
 - a. Failure to include any work item required for performance of this Contract shall not excuse Contractor from completing all work within applicable completion dates, regardless of Engineer's approval of the schedule.
 - 2. Establish procedures for monitoring and updating CPM schedule and for reporting progress. Coordinate procedures with progress meeting and payment request dates.
 - 3. Use "one workday" as the unit of time for individual activities. Indicate nonworking days and holidays incorporated into the schedule in order to coordinate with the Contract Time.
- D. CPM Schedule Preparation: Prepare a list of all activities required to complete the Work. Using the startup network diagram, prepare a skeleton network to identify probable critical paths.
- 1. Activities: Indicate the estimated time duration, sequence requirements, and relationship of each activity in relation to other activities. Include estimated time frames for the following activities:
 - a. Preparation and processing of submittals.
 - b. Mobilization and demobilization.
 - c. Purchase of materials.
 - d. Delivery.
 - e. Fabrication.
 - f. Utility interruptions.

- g. Installation.
 - h. Work by Owner that may affect or be affected by Contractor's activities.
 - i. Testing and commissioning.
 - j. Punch list and final completion.
 - k. Activities occurring following final completion.
2. Critical Path Activities: Identify critical path activities, including those for interim completion dates. Scheduled start and completion dates shall be consistent with Contract milestone dates.
 3. Processing: Process data to produce output data on a computer-drawn, time-scaled network. Revise data, reorganize activity sequences, and reproduce as often as necessary to produce the CPM schedule within the limitations of the Contract Time.
 4. Format: Mark the critical path. Locate the critical path near center of network; locate paths with most float near the edges.
 - a. Subnetworks on separate sheets are permissible for activities clearly off the critical path.
- E. Contract Modifications: For each proposed contract modification and concurrent with its submission, prepare a time-impact analysis using a network fragment to demonstrate the effect of the proposed change on the overall project schedule.
- F. Initial Issue of Schedule: Prepare initial network diagram from a sorted activity list indicating straight "early start-total float." Identify critical activities. Prepare tabulated reports showing the following:
1. Contractor or subcontractor and the Work or activity.
 2. Description of activity.
 3. Main events of activity.
 4. Immediate preceding and succeeding activities.
 5. Early and late start dates.
 6. Early and late finish dates.
 7. Activity duration in workdays.
 8. Total float or slack time.
 9. Average size of workforce.
- G. Schedule Updating: Concurrent with making revisions to schedule, prepare tabulated reports showing the following:
1. Identification of activities that have changed.
 2. Changes in early and late start dates.
 3. Changes in early and late finish dates.
 4. Changes in activity durations in workdays.
 5. Changes in the critical path.
 6. Changes in total float or slack time.
 7. Changes in the Contract Time.

2.3 REPORTS

- A. Daily Construction Reports: Prepare a daily construction report recording the following information concerning events at Project site:
1. List of subcontractors at Project site.
 2. List of separate contractors at Project site.
 3. Approximate count of personnel at Project site.
 4. Equipment at Project site.
 5. Material deliveries.
 6. High and low temperatures and general weather conditions, including presence of rain or snow.
 7. Accidents.
 8. Meetings and significant decisions.

9. Unusual events.
10. Stoppages, delays, shortages, and losses.
11. Meter readings and similar recordings.
12. Emergency procedures.
13. Orders and requests of authorities having jurisdiction.
14. Change Orders received and implemented.
15. Work Change Directives received and implemented.
16. Services connected and disconnected.
17. Equipment or system tests and startups.
18. Partial completions and occupancies.
19. Substantial Completions authorized.

- B. Site Condition Reports: Immediately on discovery of a difference between site conditions and the Contract Documents, prepare and submit a detailed report. Submit with a Request for Information. Include a detailed description of the differing conditions, together with recommendations for changing the Contract Documents.

PART 3 - EXECUTION

3.1 CONTRACTOR'S CONSTRUCTION SCHEDULE

- A. Contractor's Construction Schedule Updating: At monthly intervals, update schedule to reflect actual construction progress and activities. Issue schedule one week before each regularly scheduled progress meeting.
1. Revise schedule immediately after each meeting or other activity where revisions have been recognized or made. Issue updated schedule concurrently with the report of each such meeting.
 2. Include a report with updated schedule that indicates every change, including, but not limited to, changes in logic, durations, actual starts and finishes, and activity durations.
 3. As the Work progresses, indicate final completion percentage for each activity.
- B. Distribution: Distribute copies of approved schedule to Engineer, Owner, separate contractors, testing and inspecting agencies, and other parties identified by Contractor with a need-to-know schedule responsibility.
1. Post copies in Project meeting rooms and temporary field offices.
 2. When revisions are made, distribute updated schedules to the same parties and post in the same locations. Delete parties from distribution when they have completed their assigned portion of the Work and are no longer involved in performance of construction activities.

END OF SECTION 01 32 00

SECTION 01 32 33 - PHOTOGRAPHIC DOCUMENTATION

PART 1 - GENERAL

1.1 SUMMARY

- A. Section includes administrative and procedural requirements for the following:
 - 1. Preconstruction photographs.
- B. Related Requirements:
 - 1. Section 01 77 00 "Closeout Procedures" for submitting photographic documentation as Project Record Documents at Project closeout.

1.2 INFORMATIONAL SUBMITTALS

- A. Key Plan: Submit key plan of Project site and building with notation of vantage points marked for location and direction of each. Indicate elevation or story of construction. Include same information as corresponding photographic documentation.
- B. Digital Photographs: Submit unaltered, original, full-size image files within three days of taking photographs.
 - 1. Digital Camera: Minimum sensor resolution of 8 megapixels.
 - 2. Identification: Provide the following information with each image description in file metadata tag:
 - a. Name of Project.
 - b. Name and contact information for photographer.
 - c. Date photograph was taken.
 - d. Description of vantage point, indicating location, direction (by compass point), and elevation or story of construction.

1.3 QUALITY ASSURANCE

- A. Photographer Qualifications: An individual who has been regularly engaged as a professional photographer of construction projects for not less than three years.

1.4 USAGE RIGHTS

- A. Obtain and transfer copyright usage rights from photographer to Owner for unlimited reproduction of photographic documentation.

PART 2 - PRODUCTS

2.1 PHOTOGRAPHIC MEDIA

- A. Digital Images: Provide images in JPG format, with minimum size of 8 megapixels.

PART 3 - EXECUTION

3.1 CONSTRUCTION PHOTOGRAPHS

- A. Photographer: Engage a qualified photographer to take construction photographs.

- B. General: Take photographs using the maximum range of depth of field, and that are in focus, to clearly show the Work. Photographs with blurry or out-of-focus areas will not be accepted.
1. Maintain key plan with each set of construction photographs that identifies each photographic location.
- C. Digital Images: Submit digital images exactly as originally recorded in the digital camera, without alteration, manipulation, editing, or modifications using image-editing software.
1. Date and Time: Include date and time in file name for each image.
 2. Field Office Images: Maintain one set of images accessible in the field office at Project site, available at all times for reference. Identify images in the same manner as those submitted to Engineer.
- D. Preconstruction Photographs: Before commencement of excavation or commencement of demolition, take photographs of Project site and surrounding properties, including existing items to remain during construction, from different vantage points, as directed by Engineer.
1. Flag excavation areas and construction limits before taking construction photographs.
 2. Take a minimum of 20 photographs to show existing conditions adjacent to property before starting the Work. Additional photographs may be required depending upon the extent and variety of existing conditions.
 3. Take a minimum of 20 photographs of existing buildings either on or adjoining property to accurately record physical conditions at start of construction.
- E. Additional Photographs: Engineer may request photographs in addition to periodic photographs specified. Additional photographs will be paid for by Change Order and are not included in the Contract Sum.
1. Three days' notice will be given, where feasible.
 2. In emergency situations, take additional photographs within 24 hours of request.
 3. Circumstances that could require additional photographs include, but are not limited to, the following:
 - a. Special events planned at Project site.
 - b. Immediate follow-up when on-site events result in construction damage or losses.
 - c. Photographs to be taken at fabrication locations away from Project site. These photographs are not subject to unit prices or unit-cost allowances.
 - d. Substantial Completion of a major phase or component of the Work.
 - e. Extra record photographs at time of final acceptance.
 - f. Owner's request for special publicity photographs.

END OF SECTION 01 32 33

SECTION 01 33 00 - SUBMITTAL PROCEDURES

PART 1 - GENERAL

1.1 SUMMARY

- A. Section includes requirements for the submittal schedule and administrative and procedural requirements for submitting Shop Drawings, Product Data, Samples, and other submittals.
- B. Related Requirements:
 - 1. Section 01 32 00 "Construction Progress Documentation" for submitting schedules and reports, including Contractor's construction schedule.
 - 2. Section 01 78 23 "Operation and Maintenance Data" for submitting operation and maintenance manuals.
 - 3. Section 01 78 39 "Project Record Documents" for submitting record Drawings, record Specifications, and record Product Data.
 - 4. Section 01 79 00 "Demonstration and Training" for submitting video recordings of demonstration of equipment and training of Owner's personnel.

1.2 DEFINITIONS

- A. Action Submittals: Written and graphic information and physical samples that require Engineer's responsive action.
- B. Informational Submittals: Written and graphic information and physical samples that do not require Engineer's responsive action. Submittals may be rejected for not complying with requirements.

1.3 SUBMITTALS SCHEDULE

- A. Submittal Schedule: Submit a schedule of submittals, arranged in chronological order by dates required by construction schedule. Include time required for review, ordering, manufacturing, fabrication, and delivery when establishing dates. Include additional time required for making corrections or revisions to submittals noted by Engineer and additional time for handling and reviewing submittals required by those corrections.

1.4 SUBMITTAL ADMINISTRATIVE REQUIREMENTS

- A. Engineer's Digital Data Files: Electronic copies of digital data files of the Contract Drawings will not be provided by Engineer for Contractor's use in preparing submittals.
- B. Coordination: Coordinate preparation and processing of submittals with performance of construction activities.
 - 1. Coordinate each submittal with fabrication, purchasing, testing, delivery, other submittals, and related activities that require sequential activity.
 - 2. Coordinate transmittal of different types of submittals for related parts of the Work so processing will not be delayed because of need to review submittals concurrently for coordination.
 - a. Engineer reserves the right to withhold action on a submittal requiring coordination with other submittals until related submittals are received.
- C. Processing Time: Allow time for submittal review, including time for resubmittals, as follows. Time for review shall commence on Engineer's receipt of submittal. No extension of the

Contract Time will be authorized because of failure to transmit submittals enough in advance of the Work to permit processing, including resubmittals.

1. Initial Review: Allow 21 days for initial review of each submittal. Allow additional time if coordination with subsequent submittals is required. Engineer will advise Contractor when a submittal being processed must be delayed for coordination.
2. Intermediate Review: If intermediate submittal is necessary, process it in same manner as initial submittal.
3. Resubmittal Review: Allow 15 days for review of each resubmittal.

D. Electronic Submittals: Identify and incorporate information in each electronic submittal file as follows:

1. Assemble complete submittal package into a single indexed file incorporating submittal requirements of a single Specification Section and transmittal form with links enabling navigation to each item.
2. Name file with submittal number or other unique identifier, including revision identifier.
 - a. File name shall use Specification Section number followed by a decimal point and then a sequential number (e.g., Submittal 06 10 00.01). Resubmittals shall include an alphabetic suffix after another decimal point (e.g., Submittal 06 10 00.01.A).
3. Provide means for insertion to permanently record Contractor's review and approval markings and action taken by Engineer.
4. Transmittal Form for Electronic Submittals: Use electronic form acceptable to Owner, containing the following information:
 - a. Project name.
 - b. Date.
 - c. Name and address of Engineer.
 - d. Name of Construction Manager.
 - e. Name of Contractor.
 - f. Name of firm or entity that prepared submittal.
 - g. Names of subcontractor, manufacturer, and supplier.
 - h. Category and type of submittal.
 - i. Submittal purpose and description.
 - j. Specification Section number and title.
 - k. Specification paragraph number or drawing designation and generic name for each of multiple items.
 - l. Drawing number and detail references, as appropriate.
 - m. Location(s) where product is to be installed, as appropriate.
 - n. Related physical samples submitted directly.
 - o. Indication of full or partial submittal.
 - p. Transmittal number, numbered consecutively.
 - q. Submittal and transmittal distribution record.
 - r. Other necessary identification.
 - s. Remarks.
5. Metadata: Include the following information as keywords in the electronic submittal file metadata:
 - a. Project name.
 - b. Number and title of appropriate Specification Section.
 - c. Manufacturer name.
 - d. Product name.

E. Options: Identify options requiring selection by Engineer.

F. Deviations: Identify deviations from the Contract Documents on submittals.

G. Resubmittals: Make resubmittals in same form and number of copies as initial submittal.

1. Note date and content of previous submittal.

2. Note date and content of revision in label or title block and clearly indicate extent of revision.
 3. Resubmit submittals until they are marked with approval notation from Engineer's action stamp.
- H. Distribution: Furnish copies of final submittals to manufacturers, subcontractors, suppliers, fabricators, installers, authorities having jurisdiction, and others as necessary for performance of construction activities. Show distribution on transmittal forms.
- I. Use for Construction: Retain complete copies of submittals on Project site. Use only final action submittals that are marked with approval notation from Engineer's action stamp.

PART 2 - PRODUCTS

2.1 SUBMITTAL PROCEDURES

- A. General Submittal Procedure Requirements:
1. Submit electronic submittals via email as PDF electronic files.
 - a. Engineer will return annotated file. Annotate and retain one copy of file as an electronic Project record document file.
 2. Action Submittals: Submit four paper copies of each submittal unless otherwise indicated. Engineer will return one copy.
 3. Informational Submittals: Submit two paper copies of each submittal unless otherwise indicated. Engineer will not return copies.
 4. Certificates and Certifications Submittals: Provide a statement that includes signature of entity responsible for preparing certification. Certificates and certifications shall be signed by an officer or other individual authorized to sign documents on behalf of that entity.
 - a. Provide a digital signature with digital certificate on electronically-submitted certificates and certifications where indicated.
 - b. Provide a notarized statement on original paper copy certificates and certifications where indicated.
- B. Product Data: Collect information into a single submittal for each element of construction and type of product or equipment.
1. If information must be specially prepared for submittal because standard published data are not suitable for use, submit as Shop Drawings, not as Product Data.
 2. Mark each copy of each submittal to show which products and options are applicable. All marks on submittals to be in colors other than yellow or red. The colors yellow and red are reserved for Engineer's use only.
 3. Include the following information, as applicable:
 - a. Manufacturer's catalog cuts.
 - b. Manufacturer's product specifications.
 - c. Standard color charts.
 - d. Statement of compliance with specified referenced standards.
 - e. Testing by recognized testing agency.
 - f. Application of testing agency labels and seals.
 - g. Notation of coordination requirements.
 - h. Availability and delivery time information.
 4. For equipment, include the following in addition to the above, as applicable:
 - a. Wiring diagrams showing factory-installed wiring.
 - b. Printed performance curves.
 - c. Operational range diagrams.
 - d. Clearances required to other construction, if not indicated on accompanying Shop Drawings.
 5. Submit Product Data before or concurrent with Samples.

6. Submit Product Data in the following format:
 - a. PDF electronic file.

- C. Shop Drawings: Prepare Project-specific information, drawn accurately to scale. Do not base Shop Drawings on reproductions of the Contract Documents or standard printed data.
 1. Preparation: Fully illustrate requirements in the Contract Documents. Include the following information, as applicable:
 - a. Identification of products.
 - b. Schedules.
 - c. Compliance with specified standards.
 - d. Notation of coordination requirements.
 - e. Notation of dimensions established by field measurement.
 - f. Relationship and attachment to adjoining construction clearly indicated.
 - g. Seal and signature of professional engineer if specified.
 2. Sheet Size: Except for templates, patterns, and similar full-size drawings, submit Shop Drawings on sheets at least 8-1/2 by 11 inches, but no larger than 30 by 42 inches. Text shall be readable on the size of the drawing provided.
 3. Submit Shop Drawings in the following format:
 - a. PDF electronic file.

- D. Samples: Submit Samples for review of kind, color, pattern, and texture for a check of these characteristics with other elements and for a comparison of these characteristics between submittal and actual component as delivered and installed.
 1. Transmit Samples that contain multiple, related components such as accessories together in one submittal package.
 2. Identification: Attach label on unexposed side of Samples that includes the following:
 - a. Generic description of Sample.
 - b. Product name and name of manufacturer.
 - c. Sample source.
 - d. Number and title of applicable Specification Section.
 3. For projects where electronic submittals are required, provide corresponding electronic submittal of Sample transmittal, digital image file illustrating Sample characteristics, and identification information for record.
 4. Disposition: Maintain sets of approved Samples at Project site, available for quality-control comparisons throughout the course of construction activity. Sample sets may be used to determine final acceptance of construction associated with each set.
 - a. Samples that may be incorporated into the Work are indicated in individual Specification Sections. Such Samples must be in an undamaged condition at time of use.
 - b. Samples not incorporated into the Work, or otherwise designated as Owner's property, are the property of Contractor.
 5. Samples for Initial Selection: Submit manufacturer's color charts consisting of units or sections of units showing the full range of colors, textures, and patterns available.
 - a. Number of Samples: Submit one full set(s) of available choices where color, pattern, texture, or similar characteristics are required to be selected from manufacturer's product line. Engineer will return submittal with options selected.
 6. Samples for Verification: Submit full-size units or Samples of size indicated, prepared from same material to be used for the Work, cured and finished in manner specified, and physically identical with material or product proposed for use, and that show full range of color and texture variations expected. Samples include, but are not limited to, the following: partial sections of manufactured or fabricated components; small cuts or containers of materials; complete units of repetitively used materials; swatches showing color, texture, and pattern; color range sets; and components used for independent testing and inspection.
 - a. Number of Samples: Submit three sets of Samples. Engineer will retain two Sample sets; remainder will be returned.

- 1) If variation in color, pattern, texture, or other characteristic is inherent in material or product represented by a Sample, submit at least three sets of paired units that show approximate limits of variations.
- E. Product Schedule: As required in individual Specification Sections, prepare a written summary indicating types of products required for the Work and their intended location. Include the following information in tabular form:
1. Submit product schedule in the following format:
 - a. PDF electronic file.
 - b. Four paper copies of product schedule or list unless otherwise indicated. Engineer will return one copy.
- F. Coordination Drawings Submittals: Comply with requirements specified in Section 01 31 00 "Project Management and Coordination."
- G. Contractor's Construction Schedule: Comply with requirements specified in Section 01 32 00 "Construction Progress Documentation."
- H. Application for Payment and Schedule of Values: Comply with requirements specified in Section 01 29 00 "Payment Procedures."
- I. Test and Inspection Reports and Schedule of Tests and Inspections Submittals: Comply with requirements specified in Section 01 40 00 "Quality Requirements."
- J. Closeout Submittals and Maintenance Material Submittals: Comply with requirements specified in Section 01 77 00 "Closeout Procedures."
- K. Maintenance Data: Comply with requirements specified in Section 01 78 23 "Operation and Maintenance Data."
- L. Qualification Data: Prepare written information that demonstrates capabilities and experience of firm or person. Include lists of completed projects with project names and addresses, contact information of Engineers and owners, and other information specified.
- M. Welding Certificates: Prepare written certification that welding procedures and personnel comply with requirements in the Contract Documents. Submit record of Welding Procedure Specification and Procedure Qualification Record on AWS forms. Include names of firms and personnel certified.
- N. Installer Certificates: Submit written statements on manufacturer's letterhead certifying that Installer complies with requirements in the Contract Documents and, where required, is authorized by manufacturer for this specific Project.
- O. Manufacturer Certificates: Submit written statements on manufacturer's letterhead certifying that manufacturer complies with requirements in the Contract Documents. Include evidence of manufacturing experience where required.
- P. Product Certificates: Submit written statements on manufacturer's letterhead certifying that product complies with requirements in the Contract Documents.
- Q. Material Certificates: Submit written statements on manufacturer's letterhead certifying that material complies with requirements in the Contract Documents.

- R. Material Test Reports: Submit reports written by a qualified testing agency, on testing agency's standard form, indicating and interpreting test results of material for compliance with requirements in the Contract Documents.
- S. Product Test Reports: Submit written reports indicating that current product produced by manufacturer complies with requirements in the Contract Documents. Base reports on evaluation of tests performed by manufacturer and witnessed by a qualified testing agency, or on comprehensive tests performed by a qualified testing agency.
- T. Research Reports: Submit written evidence, from a model code organization acceptable to authorities having jurisdiction, that product complies with building code in effect for Project.
- U. Schedule of Tests and Inspections: Comply with requirements specified in Section 01 40 00 "Quality Requirements."
- V. Preconstruction Test Reports: Submit reports written by a qualified testing agency, on testing agency's standard form, indicating and interpreting results of tests performed before installation of product, for compliance with performance requirements in the Contract Documents.
- W. Compatibility Test Reports: Submit reports written by a qualified testing agency, on testing agency's standard form, indicating and interpreting results of compatibility tests performed before installation of product. Include written recommendations for primers and substrate preparation needed for adhesion.
- X. Field Test Reports: Submit written reports indicating and interpreting results of field tests performed either during installation of product or after product is installed in its final location, for compliance with requirements in the Contract Documents.
- Y. Design Data: Prepare and submit written and graphic information, including, but not limited to, performance and design criteria, list of applicable codes and regulations, and calculations. Include list of assumptions and other performance and design criteria and a summary of loads. Include load diagrams if applicable. Provide name and version of software, if any, used for calculations. Include page numbers.

PART 3 - EXECUTION

3.1 CONTRACTOR'S REVIEW

- A. Action and Informational Submittals: Review each submittal and check for coordination with other Work of the Contract and for compliance with the Contract Documents. Note corrections and field dimensions. Mark with approval stamp before submitting to Engineer.
- B. Project Closeout and Maintenance Material Submittals: See requirements in Section 01 77 00 "Closeout Procedures."
- C. Approval Stamp: Stamp each submittal with a uniform, approval stamp. Include Project name and location, submittal number, Specification Section title and number, name of reviewer, date of Contractor's approval, and statement certifying that submittal has been reviewed, checked, and approved for compliance with the Contract Documents.

3.2 DESIGN PROFESSIONAL'S ACTION

- A. General: Engineer will not review submittals that do not bear Contractor's approval stamp and will return them without action.

- B. Action Submittals: Engineer will review each submittal, make marks to indicate corrections or revisions required, and return it. Engineer will stamp each submittal with an action stamp and will mark stamp appropriately to indicate action, as follows:
1. Approved.
 2. Rejected.
 3. Approved as Noted
 4. Revise and Resubmit.
 5. Submit Specified Item.
 6. Acknowledge Receipt.
- C. Informational Submittals: Engineer will review each submittal and will not return it, or will return it if it does not comply with requirements. Engineer will forward each submittal to appropriate party.
- D. Incomplete submittals are unacceptable, will be considered nonresponsive, and will be returned for resubmittal without review.
- E. Submittals not required by the Contract Documents may not be reviewed and may be discarded or returned to Contractor marked "Not Required For Review."

END OF SECTION 01 33 00

SECTION 01 40 00 - QUALITY REQUIREMENTS

PART 1 - GENERAL

1.1 SUMMARY

- A. Section includes administrative and procedural requirements for quality assurance and quality control.
- B. Testing and inspecting services are required to verify compliance with requirements specified or indicated. These services do not relieve Contractor of responsibility for compliance with the Contract Document requirements.
 - 1. Specified tests, inspections, and related actions do not limit Contractor's other quality-assurance and -control procedures that facilitate compliance with the Contract Document requirements.
 - 2. Requirements for Contractor to provide quality-assurance and -control services required by Engineer, Owner, or authorities having jurisdiction are not limited by provisions of this Section.
 - 3. Specific test and inspection requirements are not specified in this Section.

1.2 DEFINITIONS

- A. Quality-Assurance Services: Activities, actions, and procedures performed before and during execution of the Work to guard against defects and deficiencies and substantiate that proposed construction will comply with requirements.
- B. Quality-Control Services: Tests, inspections, procedures, and related actions during and after execution of the Work to evaluate that actual products incorporated into the Work and completed construction comply with requirements. Services do not include contract enforcement activities performed by Engineer.
- C. Mockups: Full-size physical assemblies that are constructed on-site. Mockups are constructed to verify selections made under Sample submittals; to demonstrate aesthetic effects and, where indicated, qualities of materials and execution; to review coordination, testing, or operation; to show interface between dissimilar materials; and to demonstrate compliance with specified installation tolerances. Mockups are not Samples. Unless otherwise indicated, approved mockups establish the standard by which the Work will be judged.
 - 1. Laboratory Mockups: Full-size physical assemblies constructed at testing facility to verify performance characteristics.
- D. Preconstruction Testing: Tests and inspections performed specifically for Project before products and materials are incorporated into the Work, to verify performance or compliance with specified criteria.
- E. Product Testing: Tests and inspections that are performed by an NRTL, an NVLAP, or a testing agency qualified to conduct product testing and acceptable to authorities having jurisdiction, to establish product performance and compliance with specified requirements.
- F. Source Quality-Control Testing: Tests and inspections that are performed at the source, e.g., plant, mill, factory, or shop.
- G. Field Quality-Control Testing: Tests and inspections that are performed on-site for installation of the Work and for completed Work.

- H. Testing Agency: An entity engaged to perform specific tests, inspections, or both. Testing laboratory shall mean the same as testing agency.
- I. Installer/Applicator/Erector: Contractor or another entity engaged by Contractor as an employee, Subcontractor, or Sub-subcontractor, to perform a particular construction operation, including installation, erection, application, and similar operations.
 - 1. Use of trade-specific terminology in referring to a trade or entity does not require that certain construction activities be performed by accredited or unionized individuals, or that requirements specified apply exclusively to specific trade(s).
- J. Experienced: When used with an entity or individual, "experienced" means having successfully completed a minimum of five previous projects similar in nature, size, and extent to this Project; being familiar with special requirements indicated; and having complied with requirements of authorities having jurisdiction.

1.3 REGULATORY

- A. Public Agency Requirements: It is the intention of these specifications to construct all work in accordance with the applicable requirements of the Owner, the, the contract specifications, and the contract drawings. Where there is a conflict between any of the aforementioned specifications, and the permit requirements for the agency having jurisdiction, the more restrictive shall govern.

1.4 CONFLICTING REQUIREMENTS

- A. Referenced Standards: If compliance with two or more standards is specified and the standards establish different or conflicting requirements for minimum quantities or quality levels, comply with the most stringent requirement. Refer conflicting requirements that are different, but apparently equal, to Engineer for a decision before proceeding.
- B. Minimum Quantity or Quality Levels: The quantity or quality level shown or specified shall be the minimum provided or performed. The actual installation may comply exactly with the minimum quantity or quality specified, or it may exceed the minimum within reasonable limits. To comply with these requirements, indicated numeric values are minimum or maximum, as appropriate, for the context of requirements. Refer uncertainties to Engineer for a decision before proceeding.

1.5 INFORMATIONAL SUBMITTALS

- A. Testing Agency Qualifications: For testing agencies specified in "Quality Assurance" Article to demonstrate their capabilities and experience. Include proof of qualifications in the form of a recent report on the inspection of the testing agency by a recognized authority.

1.6 REPORTS AND DOCUMENTS

- A. Test and Inspection Reports: Prepare and submit certified written reports specified in other Sections. Include the following:
 - 1. Date of issue.
 - 2. Project title and number.
 - 3. Name, address, and telephone number of testing agency.
 - 4. Dates and locations of samples and tests or inspections.
 - 5. Names of individuals making tests and inspections.
 - 6. Description of the Work and test and inspection method.
 - 7. Identification of product and Specification Section.
 - 8. Complete test or inspection data.

9. Test and inspection results and an interpretation of test results.
 10. Record of temperature and weather conditions at time of sample taking and testing and inspecting.
 11. Comments or professional opinion on whether tested or inspected Work complies with the Contract Document requirements.
 12. Name and signature of laboratory inspector.
 13. Recommendations on retesting and reinspecting.
- B. Manufacturer's Technical Representative's Field Reports: Prepare written information documenting tests and inspections specified in other Sections. Include the following:
1. Name, address, and telephone number of representatives making report.
 2. Statement on condition of substrates and their acceptability for installation of product.
 3. Summary of installation procedures being followed, whether they comply with requirements and, if not, what corrective action was taken.
 4. Results of operational and other tests and a statement of whether observed performance complies with requirements.
 5. Other required items indicated in individual Specification Sections.
- C. Permits, Licenses, and Certificates: For Owner's records, submit copies of permits, licenses, certifications, inspection reports, releases, jurisdictional settlements, notices, receipts for fee payments, judgments, correspondence, records, and similar documents, established for compliance with standards and regulations bearing on performance of the Work.

1.7 QUALITY ASSURANCE

- A. General: Qualifications paragraphs in this article establish the minimum qualification levels required; individual Specification Sections specify additional requirements.
- B. Manufacturer Qualifications: A firm experienced in manufacturing products or systems similar to those indicated for this Project and with a record of successful in-service performance, as well as sufficient production capacity to produce required units.
- C. Fabricator Qualifications: A firm experienced in producing products similar to those indicated for this Project and with a record of successful in-service performance, as well as sufficient production capacity to produce required units.
- D. Installer Qualifications: A firm or individual experienced in installing, erecting, or assembling work similar in material, design, and extent to that indicated for this Project, whose work has resulted in construction with a record of successful in-service performance.
- E. Professional Engineer Qualifications: A professional engineer who is legally qualified to practice in jurisdiction where Project is located and who is experienced in providing engineering services of the kind indicated. Engineering services are defined as those performed for installations of the system, assembly, or product that are similar in material, design, and extent to those indicated for this Project.
- F. Specialists: Certain Specification Sections require that specific construction activities shall be performed by entities who are recognized experts in those operations. Specialists shall satisfy qualification requirements indicated and shall be engaged for the activities indicated.
1. Requirements of authorities having jurisdiction shall supersede requirements for specialists.
- G. Testing Agency Qualifications: An NRTL, an NVLAP, or an independent agency with the experience and capability to conduct testing and inspecting indicated, as documented according to ASTM E 329; and with additional qualifications specified in individual Sections; and, where required by authorities having jurisdiction, that is acceptable to authorities.

1. NRTL: A nationally recognized testing laboratory according to 29 CFR 1910.7.
2. NVLAP: A testing agency accredited according to NIST's National Voluntary Laboratory Accreditation Program.

H. **Manufacturer's Representative Qualifications:** An authorized representative of manufacturer who is trained and approved by manufacturer to observe and inspect installation of manufacturer's products that are similar in material, design, and extent to those indicated for this Project.

I. **Preconstruction Testing:** Where testing agency is indicated to perform preconstruction testing for compliance with specified requirements for performance and test methods, comply with the following:

1. Contractor responsibilities include the following:
 - a. Provide test specimens representative of proposed products and construction.
 - b. Submit specimens in a timely manner with sufficient time for testing and analyzing results to prevent delaying the Work.
 - c. Build laboratory mockups at testing facility using personnel, products, and methods of construction indicated for the completed Work.
 - d. When testing is complete, remove test specimens, assemblies, mockups, and laboratory mockups; do not reuse products on Project.
2. Testing Agency Responsibilities: Submit a certified written report of each test, inspection, and similar quality-assurance service to **Engineer**, with copy to Contractor. Interpret tests and inspections and state in each report whether tested and inspected work complies with or deviates from the Contract Documents.

J. **Mockups:** Before installing portions of the Work requiring mockups, build mockups for each form of construction and finish required to comply with the following requirements, using materials indicated for the completed Work:

1. Build mockups in location and of size indicated or, if not indicated, as directed by Engineer.
2. Notify Engineer seven days in advance of dates and times when mockups will be constructed.
3. Demonstrate the proposed range of aesthetic effects and workmanship.
4. Obtain Engineer's approval of mockups before starting work, fabrication, or construction.
 - a. Allow seven days for initial review and each re-review of each mockup.
5. Maintain mockups during construction in an undisturbed condition as a standard for judging the completed Work.
6. Demolish and remove mockups when directed unless otherwise indicated.

K. **Laboratory Mockups:** Comply with requirements of preconstruction testing and those specified in individual Specification Sections.

1.8 QUALITY CONTROL

A. **Owner Responsibilities:** Where quality-control services are indicated as Owner's responsibility, Owner will engage a qualified testing agency to perform these services.

1. Owner will furnish Contractor with names, addresses, and telephone numbers of testing agencies engaged and a description of types of testing and inspecting they are engaged to perform.
2. Costs for retesting and reinspecting construction that replaces or is necessitated by work that failed to comply with the Contract Documents will be charged to Contractor and the Contract Sum will be adjusted by Change Order.

B. **Contractor Responsibilities:** Tests and inspections not explicitly assigned to Owner are Contractor's responsibility. Perform additional quality-control activities required to verify that the Work complies with requirements, whether specified or not.

1. Where services are indicated as Contractor's responsibility, engage a qualified testing agency to perform these quality-control services.
 - a. Contractor shall not employ same entity engaged by Owner, unless agreed to in writing by Owner.
 2. Notify testing agencies at least 24 hours in advance of time when Work that requires testing or inspecting will be performed.
 3. Where quality-control services are indicated as Contractor's responsibility, submit a certified written report, in duplicate, of each quality-control service.
 4. Testing and inspecting requested by Contractor and not required by the Contract Documents are Contractor's responsibility.
 5. Submit additional copies of each written report directly to authorities having jurisdiction, when they so direct.
- C. Manufacturer's Field Services: Where indicated, engage a manufacturer's representative to observe and inspect the Work. Manufacturer's representative's services include examination of substrates and conditions, verification of materials, inspection of completed portions of the Work, and submittal of written reports.
- D. Retesting/Reinspecting: Regardless of whether original tests or inspections were Contractor's responsibility, provide quality-control services, including retesting and reinspecting, for construction that replaced Work that failed to comply with the Contract Documents.
- E. Testing Agency Responsibilities: Cooperate with Engineer and Contractor in performance of duties. Provide qualified personnel to perform required tests and inspections.
1. Notify Engineer and Contractor promptly of irregularities or deficiencies observed in the Work during performance of its services.
 2. Determine the location from which test samples will be taken and in which in-situ tests are conducted.
 3. Conduct and interpret tests and inspections and state in each report whether tested and inspected work complies with or deviates from requirements.
 4. Submit a certified written report, in duplicate, of each test, inspection, and similar quality-control service through Contractor.
 5. Do not release, revoke, alter, or increase the Contract Document requirements or approve or accept any portion of the Work.
 6. Do not perform any duties of Contractor.
- F. Associated Contractor Services: Cooperate with agencies performing required tests, inspections, and similar quality-control services, and provide reasonable auxiliary services as requested. Notify agency sufficiently in advance of operations to permit assignment of personnel. Provide the following:
1. Access to the Work.
 2. Incidental labor and facilities necessary to facilitate tests and inspections.
 3. Adequate quantities of representative samples of materials that require testing and inspecting. Assist agency in obtaining samples.
 4. Facilities for storage and field curing of test samples.
 5. Delivery of samples to testing agencies.
 6. Preliminary design mix proposed for use for material mixes that require control by testing agency.
 7. Security and protection for samples and for testing and inspecting equipment at Project site.
- G. Coordination: Coordinate sequence of activities to accommodate required quality-assurance and -control services with a minimum of delay and to avoid necessity of removing and replacing construction to accommodate testing and inspecting.
1. Schedule times for tests, inspections, obtaining samples, and similar activities.

1.9 SPECIAL TESTS AND INSPECTIONS

- A. Special Tests and Inspections: Conducted by a qualified testing agency as required by authorities having jurisdiction, as indicated in individual Specification Sections and as follows:
1. Notifying Engineer and Contractor promptly of irregularities and deficiencies observed in the Work during performance of its services.
 2. Submitting a certified written report of each test, inspection, and similar quality-control service to Engineer with copy to Contractor and to authorities having jurisdiction.
 3. Submitting a final report of special tests and inspections at Substantial Completion, which includes a list of unresolved deficiencies.
 4. Interpreting tests and inspections and stating in each report whether tested and inspected work complies with or deviates from the Contract Documents.
 5. Retesting and re-inspecting corrected work.

PART 2 - PRODUCTS (Not Used)

PART 3 - EXECUTION

3.1 TEST AND INSPECTION LOG

- A. Test and Inspection Log: Prepare a record of tests and inspections. Include the following:
1. Date test or inspection was conducted.
 2. Description of the Work tested or inspected.
 3. Date test or inspection results were transmitted to Engineer.
 4. Identification of testing agency or special inspector conducting test or inspection.
- B. Maintain log at Project site. Post changes and revisions as they occur. Provide access to test and inspection log for Engineer reference during normal working hours.
1. Submit log at project closeout as part of the project record documents.

3.2 REPAIR AND PROTECTION

- A. General: On completion of testing, inspecting, sample taking, and similar services, repair damaged construction and restore substrates and finishes.
1. Provide materials and comply with installation requirements specified in other Specification Sections or matching existing substrates and finishes. Restore patched areas and extend restoration into adjoining areas with durable seams that are as invisible as possible. Comply with the Contract Document requirements for cutting and patching in Section 01 73 00 "Execution."
- B. Protect construction exposed by or for quality-control service activities.
- C. Repair and protection are Contractor's responsibility, regardless of the assignment of responsibility for quality-control services.

END OF SECTION 01 40 00

SECTION 01 42 00 - REFERENCES

PART 1 - GENERAL

1.1 DEFINITIONS

- A. General: Basic Contract definitions are included in the Conditions of the Contract.
- B. "Approved": When used to convey Engineer's action on Contractor's submittals, applications, and requests, "approved" is limited to Engineer's duties and responsibilities as stated in the Conditions of the Contract.
- C. "Directed": A command or instruction by Engineer. Other terms including "requested," "authorized," "selected," "required," and "permitted" have the same meaning as "directed."
- D. "Indicated": Requirements expressed by graphic representations or in written form on Drawings, in Specifications, and in other Contract Documents. Other terms including "shown," "noted," "scheduled," and "specified" have the same meaning as "indicated."
- E. "Regulations": Laws, ordinances, statutes, and lawful orders issued by authorities having jurisdiction, and rules, conventions, and agreements within the construction industry that control performance of the Work.
- F. "Furnish": Supply and deliver to Project site, ready for unloading, unpacking, assembly, installation, and similar operations.
- G. "Install": Unload, temporarily store, unpack, assemble, erect, place, anchor, apply, work to dimension, finish, cure, protect, clean, and similar operations at Project site.
- H. "Provide": Furnish and install, complete and ready for the intended use.
- I. "Project Site": Space available for performing construction activities. The extent of Project site is shown on Drawings and may or may not be identical with the description of the land on which Project is to be built.

1.2 INDUSTRY STANDARDS

- A. Applicability of Standards: Unless the Contract Documents include more stringent requirements, applicable construction industry standards have the same force and effect as if bound or copied directly into the Contract Documents to the extent referenced. Such standards are made a part of the Contract Documents by reference.
- B. Publication Dates: Comply with standards in effect as of date of the Contract Documents unless otherwise indicated.
- C. Copies of Standards: Each entity engaged in construction on Project should be familiar with industry standards applicable to its construction activity. Copies of applicable standards are not bound with the Contract Documents.
 - 1. Where copies of standards are needed to perform a required construction activity, obtain copies directly from publication source.

1.3 ABBREVIATIONS AND ACRONYMS

- A. Industry Organizations: Where abbreviations and acronyms are used in Specifications or other Contract Documents, they shall mean the recognized name of the entities indicated in Gale's "Encyclopedia of Associations: National Organizations of the U.S." or in Columbia Books' "National Trade & Professional Associations of the United States."
- B. Industry Organizations: Where abbreviations and acronyms are used in Specifications or other Contract Documents, they shall mean the recognized name of the entities in the following list.
1. AABC - Associated Air Balance Council; www.aabc.com.
 2. AAMA - American Architectural Manufacturers Association; www.aamanet.org.
 3. AAPFCO - Association of American Plant Food Control Officials; www.aapfco.org.
 4. AASHTO - American Association of State Highway and Transportation Officials; www.transportation.org.
 5. AATCC - American Association of Textile Chemists and Colorists; www.aatcc.org.
 6. ABMA - American Bearing Manufacturers Association; www.americanbearings.org.
 7. ABMA - American Boiler Manufacturers Association; www.abma.com.
 8. ACI - American Concrete Institute; (Formerly: ACI International); www.abma.com.
 9. ACPA - American Concrete Pipe Association; www.concrete-pipe.org.
 10. AEIC - Association of Edison Illuminating Companies, Inc. (The); www.aeic.org.
 11. AF&PA - American Forest & Paper Association; www.afandpa.org.
 12. AGA - American Gas Association; www.aga.org.
 13. AHAM - Association of Home Appliance Manufacturers; www.aham.org.
 14. AHRI - Air-Conditioning, Heating, and Refrigeration Institute (The); www.ahrinet.org.
 15. AI - Asphalt Institute; www.asphaltinstitute.org.
 16. AIA - American Institute of Architects (The); www.aia.org.
 17. AISC - American Institute of Steel Construction; www.aisc.org.
 18. AISI - American Iron and Steel Institute; www.steel.org.
 19. AITC - American Institute of Timber Construction; www.aitc-glulam.org.
 20. AMCA - Air Movement and Control Association International, Inc.; www.amca.org.
 21. ANSI - American National Standards Institute; www.ansi.org.
 22. AOSA - Association of Official Seed Analysts, Inc.; www.aosaseed.com.
 23. APA - APA - The Engineered Wood Association; www.apawood.org.
 24. APA - Architectural Precast Association; www.archprecast.org.
 25. API - American Petroleum Institute; www.api.org.
 26. ARI - Air-Conditioning & Refrigeration Institute; (See AHRI).
 27. ARI - American Refrigeration Institute; (See AHRI).
 28. ARMA - Asphalt Roofing Manufacturers Association; www.asphaltroofing.org.
 29. ASCE - American Society of Civil Engineers; www.asce.org.
 30. ASCE/SEI - American Society of Civil Engineers/Structural Engineering Institute; (See ASCE).
 31. ASHRAE - American Society of Heating, Refrigerating and Air-Conditioning Engineers; www.ashrae.org.
 32. ASME - ASME International; (American Society of Mechanical Engineers); www.asme.org.
 33. ASSE - American Society of Safety Engineers (The); www.asse.org.
 34. ASSE - American Society of Sanitary Engineering; www.asse-plumbing.org.
 35. ASTM - ASTM International; www.astm.org.
 36. ATIS - Alliance for Telecommunications Industry Solutions; www.atis.org.
 37. AWEA - American Wind Energy Association; www.awea.org.
 38. AWI - Architectural Woodwork Institute; www.awinet.org.
 39. AWMAC - Architectural Woodwork Manufacturers Association of Canada; www.awmac.com.
 40. AWPA - American Wood Protection Association; www.awpa.com.
 41. AWS - American Welding Society; www.aws.org.
 42. AWWA - American Water Works Association; www.awwa.org.
 43. BHMA - Builders Hardware Manufacturers Association; www.buildershardware.com.

44. BIA - Brick Industry Association (The); www.gobrick.com.
45. BICSI - BICSI, Inc.; www.bicsi.org.
46. BIFMA - BIFMA International; (Business and Institutional Furniture Manufacturer's Association); www.bifma.org.
47. BISSC - Baking Industry Sanitation Standards Committee; www.bissc.org.
48. BWF - Badminton World Federation; (Formerly: International Badminton Federation); www.bissc.org.
49. CDA - Copper Development Association; www.copper.org.
50. CEA - Canadian Electricity Association; www.electricity.ca.
51. CEA - Consumer Electronics Association; www.ce.org.
52. CFFA - Chemical Fabrics and Film Association, Inc.; www.chemicalfabricsandfilm.com.
53. CFSEI - Cold-Formed Steel Engineers Institute; www.cfsei.org.
54. CGA - Compressed Gas Association; www.cganet.com.
55. CIMA - Cellulose Insulation Manufacturers Association; www.cellulose.org.
56. CISCA - Ceilings & Interior Systems Construction Association; www.cisca.org.
57. CISPI - Cast Iron Soil Pipe Institute; www.cispi.org.
58. CLFMI - Chain Link Fence Manufacturers Institute; www.chainlinkinfo.org.
59. CPA - Composite Panel Association; www.pbmdf.com.
60. CRI - Carpet and Rug Institute (The); www.carpet-rug.org.
61. CRRC - Cool Roof Rating Council; www.coolroofs.org.
62. CRSI - Concrete Reinforcing Steel Institute; www.crsi.org.
63. CSA - Canadian Standards Association; www.csa.ca.
64. CSA - CSA International; (Formerly: IAS - International Approval Services); www.csa-international.org.
65. CSI - Construction Specifications Institute (The); www.csinet.org.
66. CSSB - Cedar Shake & Shingle Bureau; www.cedarbureau.org.
67. CTI - Cooling Technology Institute; (Formerly: Cooling Tower Institute); www.cti.org.
68. CWC - Composite Wood Council; (See CPA).
69. DASMA - Door and Access Systems Manufacturers Association; www.dasma.com.
70. DHI - Door and Hardware Institute; www.dhi.org.
71. ECA - Electronic Components Association; (See ECIA).
72. ECAMA - Electronic Components Assemblies & Materials Association; (See ECIA).
73. ECIA - Electronic Components Industry Association; www.eciaonline.org.
74. EIA - Electronic Industries Alliance; (See TIA).
75. EIMA - EIFS Industry Members Association; www.eima.com.
76. EJMA - Expansion Joint Manufacturers Association, Inc.; www.ejma.org.
77. ESD - ESD Association; (Electrostatic Discharge Association); www.esda.org.
78. ESTA - Entertainment Services and Technology Association; (See PLASA).
79. EVO - Efficiency Valuation Organization; www.evo-world.org.
80. FCI - Fluid Controls Institute; www.fluidcontrolsinstitute.org.
81. FIBA - Federation Internationale de Basketball; (The International Basketball Federation); www.fiba.com.
82. FIVB - Federation Internationale de Volleyball; (The International Volleyball Federation); www.fivb.org.
83. FM Approvals - FM Approvals LLC; www.fmglobal.com.
84. FM Global - FM Global; (Formerly: FMG - FM Global); www.fmglobal.com.
85. FRSA - Florida Roofing, Sheet Metal & Air Conditioning Contractors Association, Inc.; www.floridarroof.com.
86. FSA - Fluid Sealing Association; www.fluidsealing.com.
87. FSC - Forest Stewardship Council U.S.; www.fscus.org.
88. GA - Gypsum Association; www.gypsum.org.
89. GANA - Glass Association of North America; www.glasswebsite.com.
90. GS - Green Seal; www.greenseal.org.
91. HI - Hydraulic Institute; www.pumps.org.
92. HI/GAMA - Hydronics Institute/Gas Appliance Manufacturers Association; (See AHRI).
93. HMMA - Hollow Metal Manufacturers Association; (See NAAMM).

94. HPVA - Hardwood Plywood & Veneer Association; www.hpva.org.
95. HPW - H. P. White Laboratory, Inc.; www.hpwhite.com.
96. IAPSC - International Association of Professional Security Consultants; www.iapsc.org.
97. IAS - International Accreditation Service; www.iasonline.org.
98. IAS - International Approval Services; (See CSA).
99. ICBO - International Conference of Building Officials; (See ICC).
100. ICC - International Code Council; www.iccsafe.org.
101. ICEA - Insulated Cable Engineers Association, Inc.; www.icea.net.
102. ICPA - International Cast Polymer Alliance; www.icpa-hq.org.
103. ICRI - International Concrete Repair Institute, Inc.; www.icri.org.
104. IEC - International Electrotechnical Commission; www.iec.ch.
105. IEEE - Institute of Electrical and Electronics Engineers, Inc. (The); www.ieee.org.
106. IES - Illuminating Engineering Society; (Formerly: Illuminating Engineering Society of North America); www.ies.org.
107. IESNA - Illuminating Engineering Society of North America; (See IES).
108. IEST - Institute of Environmental Sciences and Technology; www.iest.org.
109. IGMA - Insulating Glass Manufacturers Alliance; www.igmaonline.org.
110. IGSHPA - International Ground Source Heat Pump Association; www.igshpa.okstate.edu.
111. ILI - Indiana Limestone Institute of America, Inc.; www.iliai.com.
112. Intertek - Intertek Group; (Formerly: ETL SEMCO; Intertek Testing Service NA); www.intertek.com.
113. ISA - International Society of Automation (The); (Formerly: Instrumentation, Systems, and Automation Society); www.isa.org.
114. ISAS - Instrumentation, Systems, and Automation Society (The); (See ISA).
115. ISFA - International Surface Fabricators Association; (Formerly: International Solid Surface Fabricators Association); www.isfanow.org.
116. ISO - International Organization for Standardization; www.iso.org.
117. ISSFA - International Solid Surface Fabricators Association; (See ISFA).
118. ITU - International Telecommunication Union; www.itu.int/home.
119. KCMA - Kitchen Cabinet Manufacturers Association; www.kcma.org.
120. LMA - Laminating Materials Association; (See CPA).
121. LPI - Lightning Protection Institute; www.lightning.org.
122. MBMA - Metal Building Manufacturers Association; www.mbma.com.
123. MCA - Metal Construction Association; www.metalconstruction.org.
124. MFMA - Maple Flooring Manufacturers Association, Inc.; www.maplefloor.org.
125. MFMA - Metal Framing Manufacturers Association, Inc.; www.metalframingmfg.org.
126. MHIA - Material Handling Industry of America; www.mhia.org.
127. MIA - Marble Institute of America; www.marble-institute.com.
128. MMPA - Moulding & Millwork Producers Association; www.wmmpa.com.
129. MPI - Master Painters Institute; www.paintinfo.com.
130. MSS - Manufacturers Standardization Society of The Valve and Fittings Industry Inc.; www.mss-hq.org.
131. NAAMM - National Association of Architectural Metal Manufacturers; www.naamm.org.
132. NACE - NACE International; (National Association of Corrosion Engineers International); www.nace.org.
133. NADCA - National Air Duct Cleaners Association; www.nadca.com.
134. NAIMA - North American Insulation Manufacturers Association; www.naima.org.
135. NBGQA - National Building Granite Quarries Association, Inc.; www.nbgqa.com.
136. NBI - New Buildings Institute; www.newbuildings.org.
137. NCAA - National Collegiate Athletic Association (The); www.ncaa.org.
138. NCMA - National Concrete Masonry Association; www.ncma.org.
139. NEBB - National Environmental Balancing Bureau; www.nebb.org.
140. NECA - National Electrical Contractors Association; www.necanet.org.
141. NeLMA - Northeastern Lumber Manufacturers Association; www.nelma.org.
142. NEMA - National Electrical Manufacturers Association; www.nema.org.
143. NETA - InterNational Electrical Testing Association; www.netaworld.org.

144. NFHS - National Federation of State High School Associations; www.nfhs.org.
145. NFPA - National Fire Protection Association; www.nfpa.org.
146. NFPA - NFPA International; (See NFPA).
147. NFRC - National Fenestration Rating Council; www.nfrc.org.
148. NHLA - National Hardwood Lumber Association; www.nhla.com.
149. NLGA - National Lumber Grades Authority; www.nlga.org.
150. NOFMA - National Oak Flooring Manufacturers Association; (See NWFA).
151. NOMMA - National Ornamental & Miscellaneous Metals Association; www.nomma.org.
152. NRCA - National Roofing Contractors Association; www.nrca.net.
153. NRMCA - National Ready Mixed Concrete Association; www.nrmca.org.
154. NSF - NSF International; www.nsf.org.
155. NSPE - National Society of Professional Engineers; www.nspe.org.
156. NSSGA - National Stone, Sand & Gravel Association; www.nssga.org.
157. NTMA - National Terrazzo & Mosaic Association, Inc. (The); www.ntma.com.
158. NWFA - National Wood Flooring Association; www.nwfa.org.
159. PCI - Precast/Prestressed Concrete Institute; www.pci.org.
160. PDI - Plumbing & Drainage Institute; www.pdionline.org.
161. PLASA - PLASA; (Formerly: ESTA - Entertainment Services and Technology Association); www.plasa.org.
162. RCSC - Research Council on Structural Connections; www.boltcouncil.org.
163. RFCI - Resilient Floor Covering Institute; www.rfci.com.
164. RIS - Redwood Inspection Service; www.redwoodinspection.com.
165. SAE - SAE International; www.sae.org.
166. SCTE - Society of Cable Telecommunications Engineers; www.scte.org.
167. SDI - Steel Deck Institute; www.sdi.org.
168. SDI - Steel Door Institute; www.steeldoor.org.
169. SEFA - Scientific Equipment and Furniture Association (The); www.sefalabs.com.
170. SEI/ASCE - Structural Engineering Institute/American Society of Civil Engineers; (See ASCE).
171. SIA - Security Industry Association; www.siaonline.org.
172. SJI - Steel Joist Institute; www.steeljoist.org.
173. SMA - Screen Manufacturers Association; www.smainfo.org.
174. SMACNA - Sheet Metal and Air Conditioning Contractors' National Association; www.smacna.org.
175. SMPTE - Society of Motion Picture and Television Engineers; www.smpte.org.
176. SPFA - Spray Polyurethane Foam Alliance; www.sprayfoam.org.
177. SPIB - Southern Pine Inspection Bureau; www.spib.org.
178. SPRI - Single Ply Roofing Industry; www.spri.org.
179. SRCC - Solar Rating & Certification Corporation; www.solar-rating.org.
180. SSINA - Specialty Steel Industry of North America; www.ssina.com.
181. SSPC - SSPC: The Society for Protective Coatings; www.sspc.org.
182. STI - Steel Tank Institute; www.steel tank.com.
183. SWI - Steel Window Institute; www.steelwindows.com.
184. SWPA - Submersible Wastewater Pump Association; www.swpa.org.
185. TCA - Tilt-Up Concrete Association; www.tilt-up.org.
186. TCNA - Tile Council of North America, Inc.; www.tileusa.com.
187. TEMA - Tubular Exchanger Manufacturers Association, Inc.; www.tema.org.
188. TIA - Telecommunications Industry Association (The); (Formerly: TIA/EIA - Telecommunications Industry Association/Electronic Industries Alliance); www.tiaonline.org.
189. TIA/EIA - Telecommunications Industry Association/Electronic Industries Alliance; (See TIA).
190. TMS - The Masonry Society; www.masonrysociety.org.
191. TPI - Truss Plate Institute; www.tpinst.org.
192. TPI - Turfgrass Producers International; www.turfgrassod.org.
193. TRI - Tile Roofing Institute; www.tilerroofing.org.
194. UL - Underwriters Laboratories Inc.; www.ul.com.

195. UNI - Uni-Bell PVC Pipe Association; www.uni-bell.org.
196. USAV - USA Volleyball; www.usavolleyball.org.
197. USGBC - U.S. Green Building Council; www.usgbc.org.
198. USITT - United States Institute for Theatre Technology, Inc.; www.usitt.org.
199. WASTEC - Waste Equipment Technology Association; www.wastec.org.
200. WCLIB - West Coast Lumber Inspection Bureau; www.wclib.org.
201. WCMA - Window Covering Manufacturers Association; www.wcmanet.org.
202. WDMA - Window & Door Manufacturers Association; www.wdma.com.
203. WI - Woodwork Institute; www.wicnet.org.
204. WSRCA - Western States Roofing Contractors Association; www.wsrca.com.
205. WWPA - Western Wood Products Association; www.wwpa.org.

C. Code Agencies: Where abbreviations and acronyms are used in Specifications or other Contract Documents, they shall mean the recognized name of the entities in the following list.

1. DIN - Deutsches Institut für Normung e.V.; www.din.de.
2. IAPMO - International Association of Plumbing and Mechanical Officials; www.iapmo.org.
3. ICC - International Code Council; www.iccsafe.org.
4. ICC-ES - ICC Evaluation Service, LLC; www.icc-es.org.

D. Federal Government Agencies: Where abbreviations and acronyms are used in Specifications or other Contract Documents, they shall mean the recognized name of the entities in the following list.

1. COE - Army Corps of Engineers; www.usace.army.mil.
2. CPSC - Consumer Product Safety Commission; www.cpsc.gov.
3. DOC - Department of Commerce; National Institute of Standards and Technology; www.nist.gov.
4. DOD - Department of Defense; www.quicksearch.dla.mil.
5. DOE - Department of Energy; www.energy.gov.
6. EPA - Environmental Protection Agency; www.epa.gov.
7. FAA - Federal Aviation Administration; www.faa.gov.
8. FG - Federal Government Publications; www.gpo.gov.
9. GSA - General Services Administration; www.gsa.gov.
10. HUD - Department of Housing and Urban Development; www.hud.gov.
11. LBL - Lawrence Berkeley National Laboratory; Environmental Energy Technologies Division; www.eetd.lbl.gov.
12. OSHA - Occupational Safety & Health Administration; www.osha.gov.
13. SD - Department of State; www.state.gov.
14. TRB - Transportation Research Board; National Cooperative Highway Research Program; The National Academies; www.trb.org.
15. USDA - Department of Agriculture; Agriculture Research Service; U.S. Salinity Laboratory; www.ars.usda.gov.
16. USDA - Department of Agriculture; Rural Utilities Service; www.usda.gov.
17. USDJ - Department of Justice; Office of Justice Programs; National Institute of Justice; www.ojp.usdoj.gov.
18. USP - U.S. Pharmacopeial Convention; www.usp.org.
19. USPS - United States Postal Service; www.usps.com.

E. Standards and Regulations: Where abbreviations and acronyms are used in Specifications or other Contract Documents, they shall mean the recognized name of the standards and regulations in the following list.

1. CFR - Code of Federal Regulations; Available from Government Printing Office; www.gpo.gov/fdsys.
2. DOD - Department of Defense; Military Specifications and Standards; Available from DLA Document Services; www.quicksearch.dla.mil.
3. DSCC - Defense Supply Center Columbus; (See FS).
4. FED-STD - Federal Standard; (See FS).

5. FS - Federal Specification; Available from DLA Document Services; www.quicksearch.dla.mil.
 - a. Available from Defense Standardization Program; www.dsp.dla.mil.
 - b. Available from General Services Administration; www.gsa.gov.
 - c. Available from National Institute of Building Sciences/Whole Building Design Guide; www.wbdg.org/ccb.
 6. MILSPEC - Military Specification and Standards; (See DOD).
 7. USAB - United States Access Board; www.access-board.gov.
 8. USATBCB - U.S. Architectural & Transportation Barriers Compliance Board; (See USAB).
- F. State Government Agencies: Where abbreviations and acronyms are used in Specifications or other Contract Documents, they shall mean the recognized name of the entities in the following list.
1. CBHF; State of California; Department of Consumer Affairs; Bureau of Electronic and Appliance Repair, Home Furnishings and Thermal Insulation; www.bearhfti.ca.gov.
 2. CCR; California Code of Regulations; Office of Administrative Law; California Title 24 Energy Code; www.calregs.com.
 3. CDHS; California Department of Health Services; (See CDPH).
 4. CDPH; California Department of Public Health; Indoor Air Quality Program; www.cal-iaq.org.
 5. CPUC; California Public Utilities Commission; www.cpuc.ca.gov.
 6. EGLE; Michigan Department of Environment, Great Lakes and Energy; www.michigan.gov/egle
 7. MDOT; Michigan Department of Transportation; www.michigan.gov/mdot
 8. ODOT; Ohio Department of Transportation; www.dot.state.oh.us
 9. Ohio EPA; Ohio Environmental Protection Agency; www.epa.state.oh.us
 10. SCAQMD; South Coast Air Quality Management District; www.aqmd.gov.
 11. TFS; Texas A&M Forest Service; Sustainable Forestry and Economic Development; www.txforestservation.tamu.edu.

PART 2 - PRODUCTS (Not Used)

PART 3 - EXECUTION (Not Used)

END OF SECTION 01 42 00

SECTION 01 50 00 - TEMPORARY FACILITIES AND CONTROLS

PART 1 - GENERAL

1.1 SUMMARY

- A. Section includes requirements for temporary utilities, support facilities, and security and protection facilities.
- B. Related Requirements:
 - 1. Section 01 10 00 "Summary" for work restrictions and limitations on utility interruptions.

1.2 USE CHARGES

- A. General: Installation and removal of and use charges for temporary facilities shall be included in the Contract Sum unless otherwise indicated. Allow other entities to use temporary services and facilities without cost, including, but not limited to, Engineer, testing agencies, and authorities having jurisdiction.
- B. Water and Sewer Service from Existing System: Plant Effluent Water (PEW) from Owner's existing water system is available for use without metering and without payment of use charges. Provide connections and extensions of services as required for construction operations.
- C. Electric Power Service from Existing System: Limited electric power from Owner's existing system is available for use. Contractor to provide their own electrical power (generator) as required for construction operations.

1.3 INFORMATIONAL SUBMITTALS

- A. Site Plan: Show temporary facilities, utility hookups, staging areas, and parking areas for construction personnel.
- B. Erosion and Sedimentation Control Plan: Show compliance with requirements of EPA Construction General Permit or authorities having jurisdiction, whichever is more stringent.
- C. Fire-Safety Program: Show compliance with requirements of NFPA 241 and authorities having jurisdiction. Indicate Contractor personnel responsible for management of fire prevention program.

1.4 QUALITY ASSURANCE

- A. Electric Service: Comply with NECA, NEMA, and UL standards and regulations for temporary electric service. Install service to comply with NFPA 70.
- B. Tests and Inspections: Arrange for authorities having jurisdiction to test and inspect each temporary utility before use. Obtain required certifications and permits.
- C. Accessible Temporary Egress: Comply with applicable provisions in the United States Access Board's ADA-ABA Accessibility Guidelines.

1.5 PROJECT CONDITIONS

- A. Temporary Use of Permanent Facilities: Engage Installer of each permanent service to assume responsibility for operation, maintenance, and protection of each permanent service during its

use as a construction facility before Owner's acceptance, regardless of previously assigned responsibilities.

PART 2 - PRODUCTS

2.1 TEMPORARY FACILITIES

- A. Field Offices, General: Prefabricated or mobile units with serviceable finishes, temperature controls, and foundations adequate for normal loading.
- B. Storage and Fabrication Sheds: Provide sheds sized, furnished, and equipped to accommodate materials and equipment for construction operations.

2.2 EQUIPMENT

- A. Fire Extinguishers: Portable, UL rated; with class and extinguishing agent as required by locations and classes of fire exposures.
- B. HVAC Equipment: Unless Owner authorizes use of permanent HVAC system, provide vented, self-contained, liquid-propane-gas or fuel-oil heaters with individual space thermostatic control.
 - 1. Use of gasoline-burning space heaters, open-flame heaters, or salamander-type heating units is prohibited.
 - 2. Heating Units: Listed and labeled for type of fuel being consumed, by a qualified testing agency acceptable to authorities having jurisdiction and marked for intended location and application.
 - 3. Permanent HVAC System: If Owner authorizes use of permanent HVAC system for temporary use during construction, provide filter with MERV of 8 at each return-air grille in system and remove at end of construction and clean HVAC system as required in Section 01 77 00 "Closeout Procedures".

PART 3 - EXECUTION

3.1 INSTALLATION, GENERAL

- A. Locate facilities where they will serve Project adequately and result in minimum interference with performance of the Work. Relocate and modify facilities as required by progress of the Work.
 - 1. Locate facilities to limit site disturbance as specified in Section 01 10 00 "Summary."
- B. Provide each facility ready for use when needed to avoid delay. Do not remove until facilities are no longer needed or are replaced by authorized use of completed permanent facilities.

3.2 TEMPORARY UTILITY INSTALLATION

- A. General: Install temporary service or connect to existing service.
 - 1. Arrange with utility company, Owner, and existing users for time when service can be interrupted, if necessary, to make connections for temporary services.
- B. Potable Water Service: The Contractor shall not make a connection to any public water main or fire hydrant without first obtaining the necessary permit and/or meter from the Owner. Existing public water systems shall be operated and controlled by the Owner. All valves shall be operated exclusively by the Owner's personnel

- C. Plant Effluent Water (PEW) Service: The Contractor may make a connection, per Owner's requirements, to nearby PEW fire hydrant(s), provided coordination with Owner is completed prior to the actual connection. The PEW system is operated and controlled by Owner. All pumps and valves shall be operated exclusively by the Owner's personnel. The PEW system is the source for washwater used during backwashing of the tertiary filter units as well as other activities throughout the WWTP. Approximately 50 gpm of PEW is available for Contractor's use. Clean and maintain PEW service facilities in a condition acceptable to Owner. At Substantial Completion, restore these facilities to condition existing before initial use.
- D. Sanitary Facilities: Provide temporary toilets, wash facilities, and drinking water for use of construction personnel. Comply with requirements of authorities having jurisdiction for type, number, location, operation, and maintenance of fixtures and facilities.
- E. Heating and Cooling: Provide temporary heating and cooling required by construction activities for curing or drying of completed installations or for protecting installed construction from adverse effects of low temperatures or high humidity. Select equipment that will not have a harmful effect on completed installations or elements being installed.
- F. Ventilation and Humidity Control: Provide temporary ventilation required by construction activities for confined space entry, curing or drying of completed installations, or for protecting installed construction from adverse effects of high humidity. Select equipment that will not have a harmful effect on completed installations or elements being installed. Coordinate ventilation requirements to produce ambient condition required and minimize energy consumption.
- G. Electric Power Service: Provide temporary electric power generation, service and distribution system of sufficient size, capacity and power characteristics required for construction operations. Maintain equipment in an acceptable condition. Sound attenuation shall be provided on generation equipment to reduce noise to a level of 85 dB(A) unless otherwise permitted by Owner.
- H. Lighting: Provide temporary lighting with local switching that provides adequate illumination for construction operations, observations, inspections, and traffic conditions.
 - 1. Install and operate temporary lighting that fulfills security and protection requirements without operating entire system.

3.3 SUPPORT FACILITIES INSTALLATION

- A. General: Comply with the following:
 - 1. Provide construction for temporary offices, shops, and sheds located within construction area or within 30 feet of building lines that is noncombustible according to ASTM E 136. Comply with NFPA 241.
 - 2. Maintain support facilities until Engineer schedules Substantial Completion inspection. Remove before Substantial Completion. Personnel remaining after Substantial Completion will be permitted to use permanent facilities, under conditions acceptable to Owner.
- B. Temporary Roads and Paved Areas: Construct and maintain temporary roads and paved areas adequate for construction operations. Locate temporary roads and paved areas within construction limits indicated on Drawings.
 - 1. Provide dust-control treatment that is nonpolluting and non-tracking. Reapply treatment as required to minimize dust.
- C. Temporary Use of Permanent Roads and Paved Areas: Locate temporary roads and paved areas in same location as permanent roads and paved areas. Construct and maintain temporary roads and paved areas adequate for construction operations. Extend temporary

roads and paved areas, within construction limits indicated, as necessary for construction operations.

1. Coordinate elevations of temporary roads and paved areas with permanent roads and paved areas.

D. Parking: Provide temporary parking areas for construction personnel.

E. Project Signs: Provide Project signs as indicated. Unauthorized signs are not permitted.

1. Identification Signs: Provide Project identification signs as indicated on Drawings.
2. Temporary Signs: Provide other signs as indicated and as required to inform public and individuals seeking entrance to Project.
 - a. Provide temporary, directional signs for construction personnel and visitors.
3. Maintain and touchup signs so they are legible at all times.

F. Waste Disposal Facilities: Provide waste-collection containers in sizes adequate to handle waste from construction operations. Comply with requirements of authorities having jurisdiction. Comply with progress cleaning requirements in Section 01 73 00 "Execution."

G. Lifts and Hoists: Provide facilities necessary for hoisting materials and personnel.

1. Truck cranes and similar devices used for hoisting materials are considered "tools and equipment" and not temporary facilities.

H. Existing Elevator Use: Use of Owner's existing elevators will be permitted, provided elevators are cleaned and maintained in a condition acceptable to Owner. At Substantial Completion, restore elevators to condition existing before initial use, including replacing worn cables, guide shoes, and similar items of limited life.

1. Do not load elevators beyond their rated weight capacity.
2. Provide protective coverings, barriers, devices, signs, or other procedures to protect elevator car and entrance doors and frame. If, despite such protection, elevators become damaged, engage elevator Installer to restore damaged work so no evidence remains of correction work. Return items that cannot be refinished in field to the shop, make required repairs and refinish entire unit, or provide new units as required.

I. Existing Stair Usage: Use of Owner's existing stairs will be permitted, provided stairs are cleaned and maintained in a condition acceptable to Owner. At Substantial Completion, restore stairs to condition existing before initial use.

1. Provide protective coverings, barriers, devices, signs, or other procedures to protect stairs and to maintain means of egress. If stairs become damaged, restore damaged areas so no evidence remains of correction work.

J. Temporary Use of Permanent Stairs: Use of new stairs for construction traffic will be permitted, provided stairs are protected and finishes restored to new condition at time of Substantial Completion.

3.4 SECURITY AND PROTECTION FACILITIES INSTALLATION

A. Protection of Existing Facilities: Protect existing vegetation, equipment, structures, utilities, and other improvements at Project site and on adjacent properties, except those indicated to be removed or altered. Repair damage to existing facilities.

B. Environmental Protection: Provide protection, operate temporary facilities, and conduct construction as required to comply with environmental regulations and that minimize possible air, waterway, and subsoil contamination or pollution or other undesirable effects.

- C. Temporary Erosion and Sedimentation Control: Comply with authorities having jurisdiction and requirements of Part 91, of the Natural Resources and Environmental Protection Act 451 of 1994.
 - 1. Inspect, repair, and maintain erosion and sedimentation control measures during construction until permanent vegetation has been placed.
 - 2. Protect catch basins near or impacted by the construction activity by installing and maintaining filter fabric complying with the local authority having jurisdiction.
 - 3. If a soil erosion control permit is required on this project, adhere to the specific conditions of the project permit. Where the permit is issued in the name of the Contractor, and requires that a bond be posted, the Contractor shall include in his bid the permit fee, inspection fee, and bond expenses.
 - 4. The Engineer shall have full authority to require compliance with the soil erosion control requirements and may order suspension of the Work if measures are not adequate or a problem develops requiring additional soil erosion control measures; any ordered suspension of the Work shall not be grounds for Contractor's claims for "down time" or "lost time."

- D. Stormwater Control: Comply with requirements of authorities having jurisdiction. Provide barriers in and around excavations and subgrade construction to prevent flooding by runoff of stormwater from heavy rains.

- E. Tree and Plant Protection: Install temporary fencing located as indicated or outside the drip line of trees to protect vegetation from damage from construction operations. Protect tree root systems from damage, flooding, and erosion.

- F. Temporary Egress: Maintain temporary egress from existing occupied facilities as indicated and as required by authorities having jurisdiction.

- G. Temporary Enclosures: Provide temporary enclosures for protection of construction, in progress and completed, from exposure, foul weather, other construction operations, and similar activities. Provide temporary weather-tight enclosure for building exterior.
 - 1. Where heating or cooling is needed and permanent enclosure is not complete, insulate temporary enclosures.

- H. Temporary Fire Protection: Install and maintain temporary fire-protection facilities of types needed to protect against reasonably predictable and controllable fire losses. Comply with NFPA 241; manage fire prevention program.
 - 1. Prohibit smoking in construction areas.
 - 2. Supervise welding operations, combustion-type temporary heating units, and similar sources of fire ignition according to requirements of authorities having jurisdiction.
 - 3. Develop and supervise an overall fire-prevention and -protection program for personnel at Project site. Review needs with local fire department and establish procedures to be followed. Instruct personnel in methods and procedures. Post warnings and information.
 - 4. Provide temporary standpipes and hoses for fire protection. Hang hoses with a warning sign stating that hoses are for fire-protection purposes only and are not to be removed. Match hose size with outlet size and equip with suitable nozzles.

3.5 OPERATION, TERMINATION, AND REMOVAL

- A. Supervision: Enforce strict discipline in use of temporary facilities. To minimize waste and abuse, limit availability of temporary facilities to essential and intended uses.

- B. Maintenance: Maintain facilities in good operating condition until removal.
 - 1. Maintain operation of temporary enclosures, heating, cooling, humidity control, ventilation, and similar facilities on a 24-hour basis where required to achieve indicated results and to avoid possibility of damage.

- C. Termination and Removal: Remove each temporary facility when need for its service has ended, when it has been replaced by authorized use of a permanent facility, or no later than Substantial Completion. Complete or, if necessary, restore permanent construction that may have been delayed because of interference with temporary facility. Repair damaged Work, clean exposed surfaces, and replace construction that cannot be satisfactorily repaired.
1. Materials and facilities that constitute temporary facilities are property of Contractor. Owner reserves right to take possession of Project identification signs.
 2. At Substantial Completion, repair, renovate, and clean permanent facilities used during construction period. Comply with final cleaning requirements specified in Section 01 77 00 "Closeout Procedures."

END OF SECTION 01 50 00

SECTION 01 60 00 - PRODUCT REQUIREMENTS

PART 1 - GENERAL

1.1 SUMMARY

- A. Section includes administrative and procedural requirements for selection of products for use in Project; product delivery, storage, and handling; manufacturers' standard warranties on products; special warranties; and comparable products.
- B. Related Requirements:
 - 1. Section 01 25 00 "Substitution Procedures" for requests for substitutions.

1.2 DEFINITIONS

- A. Products: Items obtained for incorporating into the Work, whether purchased for Project or taken from previously purchased stock. The term "product" includes the terms "material," "equipment," "system," and terms of similar intent.
 - 1. Named Products: Items identified by manufacturer's product name, including make or model number or other designation shown or listed in manufacturer's published product literature, that is current as of date of the Contract Documents.
 - 2. New Products: Items that have not previously been incorporated into another project or facility. Products salvaged or recycled from other projects are not considered new products.
 - 3. Comparable Product: Product that is demonstrated and approved through submittal process to have the indicated qualities related to type, function, dimension, in-service performance, physical properties, appearance, and other characteristics that equal or exceed those of specified product.
- B. Basis-of-Design Product Specification: A specification in which a specific manufacturer's product is named and accompanied by the words "basis-of-design product," including make or model number or other designation, to establish the significant qualities related to type, function, dimension, in-service performance, physical properties, appearance, and other characteristics for purposes of evaluating comparable products of additional manufacturers named in the specification.

1.3 ACTION SUBMITTALS

- A. Comparable Product Requests: Submit request for consideration of each comparable product. Identify product or fabrication or installation method to be replaced. Include Specification Section number and title and Drawing numbers and titles.
 - 1. Engineer's Action: If necessary, Engineer will request additional information or documentation for evaluation within one week of receipt of a comparable product request. Engineer will notify Contractor of approval or rejection of proposed comparable product request within 15 days of receipt of request, or seven days of receipt of additional information or documentation, whichever is later.
 - a. Form of Approval: As specified in Section 01 33 00 "Submittal Procedures."
 - b. Use product specified if Engineer does not issue a decision on use of a comparable product request within time allocated.
- B. Basis-of-Design Product Specification Submittal: Comply with requirements in Section 01 33 00 "Submittal Procedures." Show compliance with requirements.

1.4 QUALITY ASSURANCE

- A. Compatibility of Options: If Contractor is given option of selecting between two or more products for use on Project, select product compatible with products previously selected, even if previously selected products were also options.

1.5 PRODUCT DELIVERY, STORAGE, AND HANDLING

- A. Deliver, store, and handle products using means and methods that will prevent damage, deterioration, and loss, including theft and vandalism. Comply with manufacturer's written instructions.

B. Delivery and Handling:

1. Schedule delivery to minimize long-term storage at Project site and to prevent overcrowding of construction spaces.
2. Coordinate delivery with installation time to ensure minimum holding time for items that are flammable, hazardous, easily damaged, or sensitive to deterioration, theft, and other losses.
3. Deliver products to Project site in an undamaged condition in manufacturer's original sealed container or other packaging system, complete with labels and instructions for handling, storing, unpacking, protecting, and installing.
4. Inspect products on delivery to determine compliance with the Contract Documents and to determine that products are undamaged and properly protected.

C. Storage:

1. Store products to allow for inspection and measurement of quantity or counting of units.
2. Store materials in a manner that will not endanger Project structure.
3. Store products that are subject to damage by the elements, under cover in a weathertight enclosure above ground, with ventilation adequate to prevent condensation.
4. Protect foam plastic from exposure to sunlight, except to extent necessary for period of installation and concealment.
5. Comply with product manufacturer's written instructions for temperature, humidity, ventilation, and weather-protection requirements for storage.
6. Protect stored products from damage and liquids from freezing.

1.6 PRODUCT WARRANTIES

- A. Warranties specified in other Sections shall be in addition to, and run concurrent with, other warranties required by the Contract Documents. Manufacturer's disclaimers and limitations on product warranties do not relieve Contractor of obligations under requirements of the Contract Documents.

1. Manufacturer's Warranty: Written warranty furnished by individual manufacturer for a particular product and specifically endorsed by manufacturer to Owner.
2. Special Warranty: Written warranty required by the Contract Documents to provide specific rights for Owner.

- B. Special Warranties: Prepare a written document that contains appropriate terms and identification, ready for execution.

1. Manufacturer's Standard Form: Modified to include Project-specific information and properly executed.
2. Specified Form: When specified forms are included with the Specifications, prepare a written document using indicated form properly executed.
3. Refer to other Sections for specific content requirements and particular requirements for submitting special warranties.

- C. Submittal Time: Comply with requirements in Section 01 77 00 "Closeout Procedures."

PART 2 - PRODUCTS

2.1 PRODUCT SELECTION PROCEDURES

- A. General Product Requirements: Provide products that comply with the Contract Documents, are undamaged and, unless otherwise indicated, are new at time of installation.
1. Provide products complete with accessories, trim, finish, fasteners, and other items needed for a complete installation and indicated use and effect.
 2. Standard Products: If available, and unless custom products or nonstandard options are specified, provide standard products of types that have been produced and used successfully in similar situations on other projects.
 3. Owner reserves the right to limit selection to products with warranties not in conflict with requirements of the Contract Documents.
 4. Where products are accompanied by the term "as selected," Engineer will make selection.
 5. Descriptive, performance, and reference standard requirements in the Specifications establish salient characteristics of products.
- B. Product Selection Procedures:
1. Product: Where Specifications name a single manufacturer and product, provide the named product that complies with requirements. Comparable products or substitutions for Contractor's convenience will not be considered.
 2. Manufacturer/Source: Where Specifications name a single manufacturer or source, provide a product by the named manufacturer or source that complies with requirements. Comparable products or substitutions for Contractor's convenience will not be considered.
 3. Products:
 - a. Restricted List: Where Specifications include a list of names of both manufacturers and products, provide one of the products listed that complies with requirements. Comparable products or substitutions for Contractor's convenience will not be considered unless otherwise indicated.
 - b. Nonrestricted List: Where Specifications include a list of names of both available manufacturers and products, provide one of the products listed, or an unnamed product, that complies with requirements. Comply with requirements in "Comparable Products" Article for consideration of an unnamed product.
 4. Manufacturers:
 - a. Restricted List: Where Specifications include a list of manufacturers' names, provide a product by one of the manufacturers listed that complies with requirements. Comparable products or substitutions for Contractor's convenience will not be considered unless otherwise indicated.
 - b. Nonrestricted List: Where Specifications include a list of available manufacturers, provide a product by one of the manufacturers listed, or a product by an unnamed manufacturer, that complies with requirements. Comply with requirements in "Comparable Products" Article for consideration of an unnamed manufacturer's product.
 5. Basis-of-Design Product: Where Specifications name a product, or refer to a product indicated on Drawings, and include a list of manufacturers, provide the specified or indicated product or a comparable product by one of the other named manufacturers. Drawings and Specifications indicate sizes, profiles, dimensions, and other characteristics that are based on the product named. Comply with requirements in "Comparable Products" Article for consideration of an unnamed product by one of the other named manufacturers.
- C. Visual Matching Specification: Where Specifications require "match Engineer's sample", provide a product that complies with requirements and matches Engineer's sample. Engineer's decision will be final on whether a proposed product matches.
1. If no product available within specified category matches and complies with other specified requirements, comply with requirements in Section 01 25 00 "Substitution Procedures" for proposal of product.

- D. Visual Selection Specification: Where Specifications include the phrase "as selected by Engineer from manufacturer's full range" or similar phrase, select a product that complies with requirements. Engineer will select color, gloss, pattern, density, or texture from manufacturer's product line that includes both standard and premium items.

2.2 COMPARABLE PRODUCTS

- A. Conditions for Consideration: Engineer will consider Contractor's request for comparable product when the following conditions are satisfied. If the following conditions are not satisfied, Engineer may return requests without action, except to record noncompliance with these requirements:
1. Evidence that the proposed product does not require revisions to the Contract Documents that it is consistent with the Contract Documents and will produce the indicated results, and that it is compatible with other portions of the Work.
 2. Detailed comparison of significant qualities of proposed product with those named in the Specifications. Significant qualities include attributes such as performance, weight, size, durability, visual effect, and specific features and requirements indicated.
 3. Evidence that proposed product provides specified warranty.
 4. List of similar installations for completed projects with project names and addresses and names and addresses of Engineers and owners, if requested.
 5. Samples, if requested.

PART 3 - EXECUTION (Not Used)

END OF SECTION 01 60 00

SECTION 01 73 00 - EXECUTION

PART 1 - GENERAL

1.1 SUMMARY

- A. Section includes general administrative and procedural requirements governing execution of the Work including, but not limited to, the following:
 - 1. Construction layout.
 - 2. Field engineering and surveying.
 - 3. Installation of the Work.
 - 4. Cutting and patching.
 - 5. Progress cleaning.
 - 6. Starting and adjusting.
 - 7. Protection of installed construction.

- B. Related Requirements:
 - 1. Section 01 10 00 "Summary" for limits on use of Project site.
 - 2. Section 01 77 00 "Closeout Procedures" for submitting final property survey with Project Record Documents, recording of Owner-accepted deviations from indicated lines and levels, and final cleaning.

1.2 INFORMATIONAL SUBMITTALS

- A. Certificates: Submit certificate signed by either a land surveyor or professional engineer certifying that location and elevation of improvements comply with requirements.

- B. Landfill Receipts: Submit copy of receipts issued by a landfill facility, licensed to accept hazardous materials, for hazardous waste disposal.

1.3 QUALITY ASSURANCE

- A. Land Surveyor Qualifications: A professional land surveyor who is legally qualified to practice in jurisdiction where Project is located and who is experienced in providing land-surveying services of the kind indicated.

- B. Cutting and Patching: Comply with requirements for and limitations on cutting and patching of construction elements.
 - 1. Structural Elements: When cutting and patching structural elements, notify Engineer of locations and details of cutting and await directions from Engineer before proceeding. Shore, brace, and support structural element during cutting and patching. Do not cut and patch structural elements in a manner that could change their load-carrying capacity or increase deflection
 - 2. Operational Elements: Do not cut and patch operating elements and related components in a manner that results in reducing their capacity to perform as intended or that results in increased maintenance or decreased operational life or safety.
 - 3. Other Construction Elements: Do not cut and patch other construction elements or components in a manner that could change their load-carrying capacity, that results in reducing their capacity to perform as intended, or that results in increased maintenance or decreased operational life or safety.

PART 2 - PRODUCTS

2.1 MATERIALS

- A. General: Comply with requirements specified in other Sections.
- B. In-Place Materials: Use materials for patching identical to in-place materials. For exposed surfaces, use materials that visually match in-place adjacent surfaces to the fullest extent possible.
 - 1. If identical materials are unavailable or cannot be used, use materials that, when installed, will provide a match acceptable to Engineer for the visual and functional performance of in-place materials.

PART 3 - EXECUTION

3.1 EXAMINATION

- A. Existing Conditions: The existence and location of underground and other utilities and construction indicated as existing are not guaranteed. Before beginning sitework, investigate and verify the existence and location of underground utilities, mechanical and electrical systems, and other construction affecting the Work.
 - 1. Before construction, verify the location and invert elevation at points of connection of sanitary sewer, storm sewer, and water-service piping, underground electrical services, and other utilities.
 - 2. Furnish location data for work related to Project that must be performed by public utilities serving Project site.
 - 3. For protection of underground utilities in Michigan, contact "MISS DIG" at 1-800-482-7171 a minimum of three (3) working days prior to excavating. This does not relieve the Contractor of the responsibility of notifying utility owners who may not be part of the "MISS DIG" alert system.
 - 4. Where any utility, water, sewer, gas, telephone or any other public or private utilities are encountered, the Contractor must provide adequate protection for them, and he will be held responsible for any damages to such utilities arising from his operations.
 - 5. When it is apparent that construction operations may endanger the foundation of any utility, conduit, or support of any structure, the Contractor shall notify the utility owner of this possibility, and he shall take such steps as may be required to provide temporary bracing or support of conduits or structures.
 - 6. In all cases where permits or inspection fees are required by utilities in connection with changes to or temporary support of their conduits, the Contractor shall secure permits and pay all inspection fees.
 - 7. When it is necessary in order to carry out the Work that a pole, telephone or electric, be moved to a new location or moved and replaced after construction, the Contractor shall arrange for moving such pole or poles and the lines thereof, and shall pay any charges.
 - 8. Where it is the policy of any utility owner to make his own repairs to damaged conduit or other structures, the Contractor shall cooperate to the fullest extent with the utility owner and shall see that his operations interfere as little as possible with the utility owner's operations.
 - 9. Existing Sewer Facilities: Existing sewers or drains may be encountered along the line of work. In all such cases, the Contractor shall perform his operation in such a manner that sewer service will not be interrupted. He shall, at his own expense, make all temporary provisions to maintain sewer service (both dry weather and storm flows).
 - 10. Unless otherwise indicated on the plans, the Contractor shall replace, at his own expense, any disturbed sewer or drain, or relay same at a new grade to be established by the Engineer such that sufficient clearance for the sewer will be provided.

11. Existing Water Facilities: Where existing water mains and/or water services are encountered in the work, they shall be maintained in operation. They shall be relayed if necessary, using the class of pipe and fittings standard to the Owner of the main.
12. Existing Drains: Drainage through existing sewers, ditches and drains shall be maintained at all times during construction, and all nearby gutters shall be kept open for drainage.
13. Maintenance of services as described above shall be considered as incidental to the project cost unless pay items have been included in the bid form for this work.

B. Examination and Acceptance of Conditions: Before proceeding with each component of the Work, examine substrates, areas, and conditions, with Installer or Applicator present where indicated, for compliance with requirements for installation tolerances and other conditions affecting performance. Record observations.

1. Examine roughing-in for mechanical and electrical systems to verify actual locations of connections before equipment and fixture installation.
2. Examine walls, floors, and roofs for suitable conditions where products and systems are to be installed.
3. Verify compatibility with and suitability of substrates, including compatibility with existing finishes or primers.

C. Proceed with installation only after unsatisfactory conditions have been corrected. Proceeding with the Work indicates acceptance of surfaces and conditions.

3.2 PREPARATION

A. Existing Utility Information: Furnish information to local utility that is necessary to adjust, move, or relocate existing utility structures, utility poles, lines, services, or other utility appurtenances located in or affected by construction. Coordinate with authorities having jurisdiction.

B. Field Measurements: Take field measurements as required to fit the Work properly. Recheck measurements before installing each product. Where portions of the Work are indicated to fit to other construction, verify dimensions of other construction by field measurements before fabrication. Coordinate fabrication schedule with construction progress to avoid delaying the Work.

C. Space Requirements: Verify space requirements and dimensions of items shown diagrammatically on Drawings.

D. Review of Contract Documents and Field Conditions: Immediately on discovery of the need for clarification of the Contract Documents caused by differing field conditions outside the control of Contractor, submit a request for information to Engineer according to requirements in Section 01 31 00 "Project Management and Coordination."

3.3 FIELD ENGINEERING

A. Reference Points: Locate existing permanent benchmarks, control points, and similar reference points before beginning the Work. Preserve and protect permanent benchmarks and control points during construction operations.

B. Benchmarks: Establish and maintain a minimum of two permanent benchmarks on Project site, referenced to data established by survey control points. Comply with authorities having jurisdiction for type and size of benchmark.

1. Record benchmark locations, with horizontal and vertical data, on Project Record Documents.

3.4 INSTALLATION

- A. General: Locate the Work and components of the Work accurately, in correct alignment and elevation, as indicated.
 - 1. Make vertical work plumb and make horizontal work level.
 - 2. Where space is limited, install components to maximize space available for maintenance and ease of removal for replacement.
 - 3. Conceal pipes, ducts, and wiring in finished areas unless otherwise indicated.
- B. Comply with manufacturer's written instructions and recommendations for installing products in applications indicated.
- C. Install products at the time and under conditions that will ensure the best possible results. Maintain conditions required for product performance until Substantial Completion.
- D. Conduct construction operations so no part of the Work is subjected to damaging operations or loading in excess of that expected during normal conditions of occupancy.
- E. Sequence the Work and allow adequate clearances to accommodate movement of construction items on site and placement in permanent locations.
- F. Tools and Equipment: Do not use tools or equipment that produce harmful noise levels.
- G. Templates: Obtain and distribute to the parties involved templates for work specified to be factory prepared and field installed. Check Shop Drawings of other work to confirm that adequate provisions are made for locating and installing products to comply with indicated requirements.
- H. Attachment: Provide blocking and attachment plates and anchors and fasteners of adequate size and number to securely anchor each component in place, accurately located and aligned with other portions of the Work. Where size and type of attachments are not indicated, verify size and type required for load conditions.
 - 1. Mounting Heights: Where mounting heights are not indicated, mount components at heights directed by Engineer.
 - 2. Allow for building movement, including thermal expansion and contraction.
 - 3. Coordinate installation of anchorages. Furnish setting drawings, templates, and directions for installing anchorages, including sleeves, concrete inserts, anchor bolts, and items with integral anchors, that are to be embedded in concrete or masonry. Deliver such items to Project site in time for installation.
- I. Joints: Make joints of uniform width. Where joint locations in exposed work are not indicated, arrange joints for the best visual effect. Fit exposed connections together to form hairline joints.
- J. Hazardous Materials: Use products, cleaners, and installation materials that are not considered hazardous.

3.5 CUTTING AND PATCHING

- A. Cutting and Patching, General: Employ skilled workers to perform cutting and patching. Proceed with cutting and patching at the earliest feasible time, and complete without delay.
 - 1. Cut in-place construction to provide for installation of other components or performance of other construction, and subsequently patch as required to restore surfaces to their original condition.

- B. Existing Warranties: Remove, replace, patch, and repair materials and surfaces cut or damaged during installation or cutting and patching operations, by methods and with materials so as not to void existing warranties.
- C. Temporary Support: Provide temporary support of work to be cut.
- D. Protection: Protect in-place construction during cutting and patching to prevent damage. Provide protection from adverse weather conditions for portions of Project that might be exposed during cutting and patching operations.
- E. Adjacent Occupied Areas: Avoid interference with use of adjoining areas or interruption of free passage to adjoining areas.
- F. Existing Utility Services and Mechanical/Electrical Systems: Where existing services/systems are required to be removed, relocated, or abandoned, bypass such services/systems before cutting to prevent interruption to occupied areas.
- G. Cutting: Cut in-place construction by sawing, drilling, breaking, chipping, grinding, and similar operations, including excavation, using methods least likely to damage elements retained or adjoining construction. If possible, review proposed procedures with original Installer; comply with original Installer's written recommendations.
 - 1. In general, use hand or small power tools designed for sawing and grinding, not hammering and chopping. Cut holes and slots neatly to minimum size required, and with minimum disturbance of adjacent surfaces. Temporarily cover openings when not in use.
 - 2. Finished Surfaces: Cut or drill from the exposed or finished side into concealed surfaces.
 - 3. Concrete and Masonry: Cut using a cutting machine, such as an abrasive saw or a diamond-core drill.
 - 4. Excavating and Backfilling: Comply with requirements in applicable Sections where required by cutting and patching operations.
 - 5. Mechanical and Electrical Services: Cut off pipe or conduit in walls or partitions to be removed. Cap, valve, or plug and seal remaining portion of pipe or conduit to prevent entrance of moisture or other foreign matter after cutting.
 - 6. Proceed with patching after construction operations requiring cutting are complete.
- H. Patching: Patch construction by filling, repairing, refinishing, closing up, and similar operations following performance of other work. Patch with durable seams that are as invisible as practicable. Provide materials and comply with installation requirements specified in other Sections, where applicable.
 - 1. Inspection: Where feasible, test and inspect patched areas after completion to demonstrate physical integrity of installation.
 - 2. Exposed Finishes: Restore exposed finishes of patched areas and extend finish restoration into retained adjoining construction in a manner that will minimize evidence of patching and refinishing.

3.6 PROGRESS CLEANING

- A. General: Clean Project site and work areas daily, including common areas. Enforce requirements strictly. Dispose of materials lawfully.
 - 1. Comply with requirements in NFPA 241 for removal of combustible waste materials and debris.
 - 2. Do not hold waste materials more than seven days during normal weather or three days if the temperature is expected to rise above 80°F.
 - 3. Containerize hazardous and unsanitary waste materials separately from other waste. Mark containers appropriately and dispose of legally, according to regulations.

- B. Site: Maintain Project site free of waste materials and debris.
- C. Work Areas: Clean areas where work is in progress to the level of cleanliness necessary for proper execution of the Work.
 - 1. Remove liquid spills promptly.
 - 2. Where dust would impair proper execution of the Work, broom-clean or vacuum the entire work area, as appropriate.
- D. Installed Work: Keep installed work clean. Clean installed surfaces according to written instructions of manufacturer or fabricator of product installed, using only cleaning materials specifically recommended. If specific cleaning materials are not recommended, use cleaning materials that are not hazardous to health or property and that will not damage exposed surfaces.
- E. Concealed Spaces: Remove debris from concealed spaces before enclosing the space.
- F. Exposed Surfaces in Finished Areas: Clean exposed surfaces and protect as necessary to ensure freedom from damage and deterioration at time of Substantial Completion.
- G. Waste Disposal: Do not bury or burn waste materials on-site. Do not wash waste materials down sewers or into waterways.
- H. During handling and installation, clean and protect construction in progress and adjoining materials already in place. Apply protective covering where required to ensure protection from damage or deterioration at Substantial Completion.
- I. Clean and provide maintenance on completed construction as frequently as necessary through the remainder of the construction period. Adjust and lubricate operable components to ensure operability without damaging effects.
- J. Limiting Exposures: Supervise construction operations to assure that no part of the construction, completed or in progress, is subject to harmful, dangerous, damaging, or otherwise deleterious exposure during the construction period.

3.7 DUST CONTROL

- A. Maintain haul roads, detour roads, other public or private roads, driveways and parking lots in a dust free condition for the duration of the Contract.
- B. Control dust by application of dust control materials and application methods as approved and as directed by the Engineer.
- C. Dust control materials shall be applied as often as is necessary to control dust. Neglect of dust control will not be tolerated.
- D. Should the Contractor be negligent of his duties in providing dust control, the Owner may, with or without notice cause the same to be done and deduct the cost of such work from any monies due or to become due to the Contractor under the Contract. Cost of providing dust control shall be considered incidental to the Work.

3.8 STREET CLEANING

- A. Haul roads, detour roads, other public or private roads, driveways and parking lots will be kept clean and swept at regular intervals to maintain cleanliness.

- B. Trucks hauling excavated material, cement, sand, stone or other loose materials from or to the site shall be tightly covered so that no spillage will occur on the adjacent streets. Before trucks start away from the site, their loads shall be trimmed and covered.
- C. If, in the judgment of the Owner, adequate cleanup efforts are not being expended, including but not limited to, roadway, driveway and drainage maintenance, and removal of surplus materials, further construction shall be halted and work forces directed to the cleanup activity until proper order is restored. Should the Contractor continue to be negligent of his duties in maintaining proper street cleanliness, the Owner will take necessary steps to perform such cleaning and shall charge the Contractor for all costs.

3.9 STARTING AND ADJUSTING

- A. Start equipment and operating components to confirm proper operation. Remove malfunctioning units, replace with new units, and retest.
- B. Adjust equipment for proper operation. Adjust operating components for proper operation without binding.
- C. Test each piece of equipment to verify proper operation. Test and adjust controls and safeties. Replace damaged and malfunctioning controls and equipment.
- D. Manufacturer's Field Service: Comply with qualification requirements in Section 01 40 00 "Quality Requirements"

3.10 PROTECTION OF INSTALLED CONSTRUCTION

- A. Provide final protection and maintain conditions that ensure installed Work is without damage or deterioration at time of Substantial Completion.
- B. Comply with manufacturer's written instructions for temperature and relative humidity.
- C. Provide and maintain weather protection and heating at Contractor's expense to properly protect the Work under construction from damage if the weather conditions require. This work shall include all windbreaks, insulation cover, and other necessary measures required to provide protection from freezing. Continue to provide weather protection and heating as necessary until such time as the Owner takes over the facility.

END OF SECTION 01 73 00

SECTION 01 77 00 - CLOSEOUT PROCEDURES

PART 1 - GENERAL

1.1 SUMMARY

- A. Section includes administrative and procedural requirements for contract closeout, including, but not limited to, the following:
 - 1. Substantial Completion procedures.
 - 2. Final completion procedures.
 - 3. Warranties.
 - 4. Final cleaning.
 - 5. Repair of the Work.
- B. Related Requirements:
 - 1. Section 01 32 33 "Photographic Documentation" for submitting final completion construction photographic documentation.
 - 2. Section 01 78 23 "Operation and Maintenance Data" for operation and maintenance manual requirements.
 - 3. Section 01 78 39 "Project Record Documents" for submitting record Drawings, record Specifications, and record Product Data.
 - 4. Section 01 79 00 "Demonstration and Training" for requirements for instructing Owner's personnel.

1.2 ACTION SUBMITTALS

- A. Product Data: For cleaning agents.
- B. Contractor's List of Incomplete Items: Initial submittal at Substantial Completion.
- C. Certified List of Incomplete Items: Final submittal at Final Completion.

1.3 CLOSEOUT SUBMITTALS

- A. Certificates of Release: From authorities having jurisdiction.
- B. Certificate of Insurance: For continuing coverage.
- C. Field Report: For pest control inspection.

1.4 MAINTENANCE MATERIAL SUBMITTALS

- A. Schedule of Maintenance Material Items: For maintenance material submittal items specified in other Sections.

1.5 SUBSTANTIAL COMPLETION PROCEDURES

- A. Contractor's List of Incomplete Items: Prepare and submit a list of items to be completed and corrected (Contractor's punch list), indicating the value of each item on the list and reasons why the Work is incomplete.
- B. Submittals Prior to Substantial Completion: Complete the following a minimum of 10 days prior to requesting inspection for determining date of Substantial Completion. List items below that are incomplete at time of request.

1. Certificates of Release: Obtain and submit releases from authorities having jurisdiction permitting Owner unrestricted use of the Work and access to services and utilities. Include occupancy permits, operating certificates, and similar releases.
 2. Submit closeout submittals specified in other Division 01 Sections, including project record documents, operation and maintenance manuals, final completion construction photographic documentation, damage or settlement surveys, property surveys, and similar final record information.
 3. Submit closeout submittals specified in individual Sections, including specific warranties, workmanship bonds, maintenance service agreements, final certifications, and similar documents.
 4. Submit maintenance material submittals specified in individual Sections, including tools, spare parts, extra materials, and similar items, and deliver to location designated by Engineer Label with manufacturer's name and model number where applicable.
 - a. Schedule of Maintenance Material Items: Prepare and submit schedule of maintenance material submittal items, including name and quantity of each item and name and number of related Specification Section. Obtain Engineer's signature for receipt of submittals.
 5. Submit test/adjust/balance records.
 6. Submit sustainable design submittals not previously submitted.
 7. Submit changeover information related to Owner's occupancy, use, operation, and maintenance.
- C. Procedures Prior to Substantial Completion: Complete the following a minimum of 10 days prior to requesting inspection for determining date of Substantial Completion. List items below that are incomplete at time of request.
1. Advise Owner of pending insurance changeover requirements.
 2. Make final changeover of permanent locks and deliver keys to Owner. Advise Owner's personnel of changeover in security provisions.
 3. Complete startup and testing of systems and equipment.
 4. Perform preventive maintenance on equipment used prior to Substantial Completion.
 5. Instruct Owner's personnel in operation, adjustment, and maintenance of products, equipment, and systems. Submit demonstration and training video recordings specified in Section 01 79 00 "Demonstration and Training."
 6. Advise Owner of changeover in heat and other utilities.
 7. Participate with Owner in conducting inspection and walkthrough with local emergency responders.
 8. Terminate and remove temporary facilities from Project site, along with mockups, construction tools, and similar elements.
 9. Complete final cleaning requirements, including touchup painting.
 10. Touch up and otherwise repair and restore marred exposed finishes to eliminate visual defects.
- D. Inspection: Submit a written request for inspection to determine Substantial Completion a minimum of 10 days prior to date the work will be completed and ready for final inspection and tests. On receipt of request, Engineer will either proceed with inspection or notify Contractor of unfulfilled requirements. Engineer will prepare the Certificate of Substantial Completion after inspection or will notify Contractor of items, either on Contractor's list or additional items identified by Engineer, that must be completed or corrected before certificate will be issued.
1. Reinspection: Request reinspection when the Work identified in previous inspections as incomplete is completed or corrected.
 2. Results of completed inspection will form the basis of requirements for final completion.

1.6 FINAL COMPLETION PROCEDURES

- A. Preliminary Procedures: Before requesting final inspection for determining final completion, complete the following:

1. Submit a final Application for Payment according to Section 01 29 00 "Payment Procedures."
2. Certified List of Incomplete Items: Submit certified copy of Engineer's Substantial Completion inspection list of items to be completed or corrected (punch list), endorsed and dated by Engineer. Certified copy of the list shall state that each item has been completed or otherwise resolved for acceptance.
3. Certificate of Insurance: Submit evidence of final, continuing insurance coverage complying with insurance requirements.
4. Submit pest-control final inspection report and warranty.
5. Instruct Owner's personnel in operation, adjustment, and maintenance of products, equipment, and systems. Submit demonstration and training video recordings and manufacturer's startup reports.

B. Inspection: Submit a written request for final inspection to determine acceptance. On receipt of request, Engineer will either proceed with inspection or notify Contractor of unfulfilled requirements. Engineer will prepare a final Certificate for Payment after inspection or will notify Contractor of construction that must be completed or corrected before certificate will be issued.

1. Reinspection: Request reinspection when the Work identified in previous inspections as incomplete is completed or corrected.

1.7 LIST OF INCOMPLETE ITEMS (PUNCH LIST)

A. Organization of List: Include name and identification of each space and area affected by construction operations for incomplete items and items needing correction including, if necessary, areas disturbed by Contractor that are outside the limits of construction. Use CSI Form 14.1A or similar type form.

1. Organize list of spaces in sequential order, starting with exterior areas first and proceeding from lowest floor to highest floor.
2. Organize items applying to each space by major element, including categories for ceiling, individual walls, floors, equipment, and building systems.
3. Submit list of incomplete items in one of the following formats:
 - a. MS Excel electronic file. Engineer will return annotated copy.
 - b. PDF electronic file. Engineer will return annotated copy.
 - c. Web-based project software upload. Utilize software feature for creating and updating list of incomplete items (punch list).
 - d. Three paper copies. Engineer will return two copies.

1.8 SUBMITTAL OF PROJECT WARRANTIES

A. Time of Submittal: Submit written warranties on request of Engineer for designated portions of the Work where commencement of warranties other than date of Substantial Completion is indicated, or when delay in submittal of warranties might limit Owner's rights under warranty.

B. Organize warranty documents into an orderly sequence based on the table of contents of the Project Manual.

1. Bind warranties and bonds in heavy-duty, three-ring, vinyl-covered, loose-leaf binders, thickness as necessary to accommodate contents, and sized to receive 8-1/2-by-11-inch paper.
2. Provide heavy paper dividers with plastic-covered tabs for each separate warranty. Mark tab to identify the product or installation. Provide a typed description of the product or installation, including the name of the product and the name, address, and telephone number of Installer.
3. Identify each binder on the front and spine with the typed or printed title "WARRANTIES," Project name, and name of Contractor.

4. Warranty Electronic File: Scan warranties and bonds and assemble complete warranty and bond submittal package into a single indexed electronic PDF file with links enabling navigation to each item. Provide bookmarked table of contents at beginning of document.

C. Provide additional copies of each warranty to include in operation and maintenance manuals.

PART 2 - PRODUCTS

2.1 MATERIALS

- A. Cleaning Agents: Use cleaning materials and agents recommended by manufacturer or fabricator of the surface to be cleaned. Do not use cleaning agents that are potentially hazardous to health or property or that might damage finished surfaces.

PART 3 - EXECUTION

3.1 FINAL CLEANING

- A. General: Perform final cleaning. Conduct cleaning and waste-removal operations to comply with local laws and ordinances and Federal and local environmental and antipollution regulations.
- B. Cleaning: Employ experienced workers or professional cleaners for final cleaning. Clean each surface or unit to condition expected in an average commercial building cleaning and maintenance program. Comply with manufacturer's written instructions.
 1. Complete the following cleaning operations before requesting inspection for certification of Substantial Completion for entire Project or for a designated portion of Project:
 - a. Clean Project site, yard, and grounds, in areas disturbed by construction activities, including landscape development areas, of rubbish, waste material, litter, and other foreign substances.
 - b. Sweep paved areas broom clean. Remove petrochemical spills, stains, and other foreign deposits.
 - c. Rake grounds that are neither planted nor paved to a smooth, even-textured surface.
 - d. Remove tools, construction equipment, machinery, and surplus material from Project site.
 - e. Remove snow and ice to provide safe access to building.
 - f. Clean exposed exterior and interior hard-surfaced finishes to a dirt-free condition, free of stains, films, and similar foreign substances. Avoid disturbing natural weathering of exterior surfaces. Restore reflective surfaces to their original condition.
 - g. Remove debris and surface dust from limited access spaces, including roofs, plenums, shafts, trenches, equipment vaults, manholes, attics, and similar spaces.
 - h. Sweep concrete floors broom clean in unoccupied spaces.
 - i. Vacuum carpet and similar soft surfaces, removing debris and excess nap; clean according to manufacturer's recommendations if visible soil or stains remain.
 - j. Clean transparent materials, including mirrors and glass in doors and windows. Remove glazing compounds and other noticeable, vision-obscuring materials. Replace chipped or broken glass and other damaged transparent materials. Polish mirrors and glass, taking care not to scratch surfaces.
 - k. Remove labels that are not permanent.
 - l. Wipe surfaces of mechanical and electrical equipment, elevator equipment, and similar equipment. Remove excess lubrication, paint and mortar droppings, and other foreign substances.
 - m. Clean plumbing fixtures to a sanitary condition, free of stains, including stains resulting from water exposure.

- n. Replace disposable air filters and clean permanent air filters. Clean exposed surfaces of diffusers, registers, and grills.
 - o. Clean light fixtures, lamps, globes, and reflectors to function with full efficiency.
 - p. Leave Project clean and ready for occupancy.
- C. Pest Control: Comply with pest control requirements in Section 01 50 00 "Temporary Facilities and Controls." Prepare written report.

3.2 REPAIR OF THE WORK

- A. Complete repair and restoration operations before requesting inspection for determination of Substantial Completion.
- B. Repair or remove and replace defective construction. Repairing includes replacing defective parts, refinishing damaged surfaces, touching up with matching materials, and properly adjusting operating equipment. Where damaged or worn items cannot be repaired or restored, provide replacements. Remove and replace operating components that cannot be repaired. Restore damaged construction and permanent facilities used during construction to specified condition.
- 1. Remove and replace chipped, scratched, and broken glass, reflective surfaces, and other damaged transparent materials.
 - 2. Touch up and otherwise repair and restore marred or exposed finishes and surfaces. Replace finishes and surfaces that already show evidence of repair or restoration.
 - a. Do not paint over "UL" and other required labels and identification, including mechanical and electrical nameplates. Remove paint applied to required labels and identification.
 - 3. Replace parts subject to operating conditions during construction that may impede operation or reduce longevity.
 - 4. Replace burned-out bulbs, bulbs noticeably dimmed by hours of use, and defective and noisy starters in fluorescent and mercury vapor fixtures to comply with requirements for new fixtures.

END OF SECTION 01 77 00

SECTION 01 78 23 - OPERATION AND MAINTENANCE DATA

PART 1 - GENERAL

1.1 SUMMARY

- A. Section includes administrative and procedural requirements for preparing operation and maintenance manuals, including the following:
1. Operation and maintenance documentation directory.
 2. Operation manuals for systems, subsystems, and equipment.
 3. Product maintenance manuals.
 4. Systems and equipment maintenance manuals.

1.2 CLOSEOUT SUBMITTALS

- A. Manual Content: Operations and maintenance manual content is specified in individual Specification Sections to be reviewed at the time of Section submittals. Submit reviewed manual content formatted and organized as required by this Section.
1. Engineer will comment on whether content of operations and maintenance submittals are acceptable.
 2. Where applicable, clarify and update reviewed manual content to correspond to revisions and field conditions.
- B. Format: Submit operations and maintenance manuals in the following format:
1. PDF electronic file. Assemble each manual into a composite electronically indexed file. Submit on digital media acceptable to Engineer.
 - a. Name each indexed document file in composite electronic index with applicable item name. Include a complete electronically linked operation and maintenance directory.
 - b. Enable inserted reviewer comments on draft submittals.
 2. One paper copy upon Engineer Acknowledgment. Include a complete operation and maintenance directory. Enclose title pages and directories in clear plastic sleeves.
- C. Manual Submittal: Submit each manual in final form prior to requesting inspection for Substantial Completion and at least 15 days before equipment installation or commencing demonstration and training; whichever is earliest. Engineer will return copy with comments.
1. Correct or revise each manual to comply with Engineer's comments. Submit copies of each corrected manual within 15 days of receipt of Engineer's comments and prior to equipment installation or commencing demonstration and training.

PART 2 - PRODUCTS

2.1 REQUIREMENTS FOR EMERGENCY, OPERATION, AND MAINTENANCE MANUALS

- A. Directory: Prepare a single, comprehensive directory of emergency, operation, and maintenance data and materials, listing items and their location to facilitate ready access to desired information.
- B. Organization: Unless otherwise indicated, organize each manual into a separate section for each system and subsystem, and a separate section for each piece of equipment not part of a system. Each manual shall contain the following materials, in the order listed:
1. Title page.
 2. Table of contents.
 3. Manual contents.

- C. Title Page: Include the following information:
1. Subject matter included in manual.
 2. Name and address of Project.
 3. Name and address of Owner.
 4. Date of submittal.
 5. Name and contact information for Contractor.
 6. Name and contact information for Engineer.
 7. Name and contact information for Commissioning Authority.
 8. Names and contact information for major consultants to the Engineer that designed the systems contained in the manuals.
 9. Cross-reference to related systems in other operation and maintenance manuals.
- D. Table of Contents: List each product included in manual, identified by product name, indexed to the content of the volume, and cross-referenced to Specification Section number in Project Manual.
- E. Manual Contents: Organize into sets of manageable size. Arrange contents alphabetically by system, subsystem, and equipment. If possible, assemble instructions for subsystems, equipment, and components of one system into a single binder.
- F. Manuals, Electronic Files: Submit manuals in the form of a multiple file composite electronic PDF file for each manual type required.
1. Electronic Files: Use electronic files prepared by manufacturer where available. Where scanning of paper documents is required, configure scanned file for minimum readable file size.
 2. File Names and Bookmarks: Enable bookmarking of individual documents based on file names. Name document files to correspond to system, subsystem, and equipment names used in manual directory and table of contents. Group documents for each system and subsystem into individual composite bookmarked files, then create composite manual, so that resulting bookmarks reflect the system, subsystem, and equipment names in a readily navigated file tree. Configure electronic manual to display bookmark panel on opening file.
- G. Manuals, Paper Copy: Submit manuals in the form of hard copy, bound and labeled volumes.
1. Binders: Heavy-duty, three-ring, vinyl-covered, post-type binders, in thickness necessary to accommodate contents, sized to hold 8-1/2-by-11-inch paper; with clear plastic sleeve on spine to hold label describing contents and with pockets inside covers to hold folded oversize sheets.
 - a. Identify each binder on front and spine, with printed title "OPERATION AND MAINTENANCE MANUAL," Project title or name, and subject matter of contents, and indicate Specification Section number on bottom of spine. Indicate volume number for multiple-volume sets.
 2. Dividers: Heavy-paper dividers with plastic-covered tabs for each section of the manual. Mark each tab to indicate contents. Include typed list of products and major components of equipment included in the section on each divider, cross-referenced to Specification Section number and title of Project Manual.
 3. Protective Plastic Sleeves: Transparent plastic sleeves designed to enclose diagnostic software storage media for computerized electronic equipment.
 4. Drawings: Attach reinforced, punched binder tabs on drawings and bind with text.
 - a. If oversize drawings are necessary, fold drawings to same size as text pages and use as foldouts.
 - b. If drawings are too large to be used as foldouts, fold and place drawings in labeled envelopes and bind envelopes in rear of manual. At appropriate locations in manual, insert typewritten pages indicating drawing titles, descriptions of contents, and drawing locations.

2.2 OPERATION MANUALS

- A. Content: In addition to requirements in this Section, include operation data required in individual Specification Sections and the following information:
1. System, subsystem, and equipment descriptions. Use designations for systems and equipment indicated on Contract Documents.
 2. Performance and design criteria if Contractor is delegated design responsibility.
 3. Operating standards.
 4. Operating procedures.
 5. Operating logs.
 6. Wiring diagrams.
 7. Control diagrams.
 8. Piped system diagrams.
 9. Precautions against improper use.
 10. License requirements including inspection and renewal dates.
- B. Descriptions: Include the following:
1. Product name and model number. Use designations for products indicated on Contract Documents.
 2. Manufacturer's name.
 3. Equipment identification with serial number of each component.
 4. Equipment function.
 5. Operating characteristics.
 6. Limiting conditions.
 7. Performance curves.
 8. Engineering data and tests.
 9. Complete nomenclature and number of replacement parts.
- C. Operating Procedures: Include the following, as applicable:
1. Startup procedures.
 2. Equipment or system break-in procedures.
 3. Routine and normal operating instructions.
 4. Regulation and control procedures.
 5. Instructions on stopping.
 6. Normal shutdown instructions.
 7. Seasonal and weekend operating instructions.
 8. Required sequences for electric or electronic systems.
 9. Special operating instructions and procedures.
- D. Systems and Equipment Controls: Describe the sequence of operation, and diagram controls as installed.
- E. Piped Systems: Diagram piping as installed, and identify color-coding where required for identification.

2.3 PRODUCT MAINTENANCE MANUALS

- A. Content: Organize manual into a separate section for each product, material, and finish. Include source information, product information, maintenance procedures, repair materials and sources, and warranties and bonds, as described below.
- B. Source Information: List each product included in manual, identified by product name and arranged to match manual's table of contents. For each product, list name, address, and telephone number of Installer or supplier and maintenance service agent, and cross-reference Specification Section number and title in Project Manual.

- C. Product Information: Include the following, as applicable:
 - 1. Product name and model number.
 - 2. Manufacturer's name.
 - 3. Color, pattern, and texture.
 - 4. Material and chemical composition.
 - 5. Reordering information for specially manufactured products.

- D. Maintenance Procedures: Include manufacturer's written recommendations and the following:
 - 1. Inspection procedures.
 - 2. Types of cleaning agents to be used and methods of cleaning.
 - 3. List of cleaning agents and methods of cleaning detrimental to product.
 - 4. Schedule for routine cleaning and maintenance.
 - 5. Repair instructions.

- E. Repair Materials and Sources: Include lists of materials and local sources of materials and related services.

- F. Warranties and Bonds: Include copies of warranties and bonds and lists of circumstances and conditions that would affect validity of warranties or bonds.

2.4 SYSTEMS AND EQUIPMENT MAINTENANCE MANUALS

- A. Content: For each system, subsystem, and piece of equipment not part of a system, include source information, manufacturers' maintenance documentation, maintenance procedures, maintenance and service schedules, spare parts list and source information, maintenance service contracts, and warranty and bond information, as described below.

- B. Source Information: List each system, subsystem, and piece of equipment included in manual, identified by product name and arranged to match manual's table of contents. For each product, list name, address, and telephone number of Installer or supplier and maintenance service agent, and cross-reference Specification Section number and title in Project Manual.

- C. Manufacturers' Maintenance Documentation: Manufacturers' maintenance documentation including the following information for each component part or piece of equipment:
 - 1. Standard maintenance instructions and bulletins.
 - 2. Drawings, diagrams, and instructions required for maintenance, including disassembly and component removal, replacement, and assembly.
 - 3. Identification and nomenclature of parts and components.
 - 4. List of items recommended to be stocked as spare parts.

- D. Maintenance Procedures: Include the following information and items that detail essential maintenance procedures:
 - 1. Test and inspection instructions.
 - 2. Troubleshooting guide.
 - 3. Precautions against improper maintenance.
 - 4. Disassembly; component removal, repair, and replacement; and reassembly instructions.
 - 5. Aligning, adjusting, and checking instructions.
 - 6. Demonstration and training video recording, if available.

- E. Maintenance and Service Schedules: Include service and lubrication requirements, list of required lubricants for equipment, and separate schedules for preventive and routine maintenance and service with standard time allotment.

- F. Spare Parts List and Source Information: Include lists of replacement and repair parts, with parts identified and cross-referenced to manufacturers' maintenance documentation and local sources of maintenance materials and related services.
- G. Warranties and Bonds: Include copies of warranties and bonds and lists of circumstances and conditions that would affect validity of warranties or bonds.

PART 3 - EXECUTION

3.1 MANUAL PREPARATION

- A. Emergency Manual: Assemble a complete set of emergency information indicating procedures for use by emergency personnel and by Owner's operating personnel for types of emergencies indicated.
- B. Product Maintenance Manual: Assemble a complete set of maintenance data indicating care and maintenance of each product, material, and finish incorporated into the Work.
- C. Operation and Maintenance Manuals: Assemble a complete set of operation and maintenance data indicating operation and maintenance of each system, subsystem, and piece of equipment not part of a system.
- D. Manufacturers' Data: Where manuals contain manufacturers' standard printed data, include only sheets pertinent to product or component installed. Mark each sheet to identify each product or component incorporated into the Work. If data include more than one item in a tabular format, identify each item using appropriate references from the Contract Documents. Identify data applicable to the Work and delete references to information not applicable.
- E. Drawings: Prepare drawings supplementing manufacturers' printed data to illustrate the relationship of component parts of equipment and systems and to illustrate control sequence and flow diagrams. Coordinate these drawings with information contained in record Drawings to ensure correct illustration of completed installation.
 - 1. Do not use original project record documents as part of operation and maintenance manuals.
- F. Comply with Section 01 77 00 "Closeout Procedures" for schedule for submitting operation and maintenance documentation.

END OF SECTION 01 78 23

SECTION 01 78 39 - PROJECT RECORD DOCUMENTS

PART 1 - GENERAL

1.1 SUMMARY

- A. Section includes administrative and procedural requirements for project record documents, including the following:
 - 1. Record Drawings.
 - 2. Record Specifications.
 - 3. Record Product Data.
- B. Related Requirements:
 - 1. Section 01 78 23 "Operation and Maintenance Data" for operation and maintenance manual requirements.

1.2 CLOSEOUT SUBMITTALS

- A. Record Drawings: Comply with the following:
 - 1. Number of Copies: Submit two sets of marked-up record prints.
- B. Record Specifications: Submit one paper copy and one annotated PDF electronic files of Project's Specifications, including addenda and contract modifications.
- C. Record Product Data: Submit one paper copy and one annotated PDF electronic files and directories of each submittal.

PART 2 - PRODUCTS

2.1 RECORD DRAWINGS

- A. Record Prints: Maintain one set of marked-up paper copies of the Contract Drawings and Shop Drawings, incorporating new and revised Drawings as modifications are issued.
 - 1. Preparation: Mark record prints to show the actual installation where installation varies from that shown originally. Require individual or entity who obtained record data, whether individual or entity is Installer, subcontractor, or similar entity, to provide information for preparation of corresponding marked-up record prints.
 - a. Give particular attention to information on concealed elements that would be difficult to identify or measure and record later.
 - b. Record data as soon as possible after obtaining it.
 - c. Record and check the markup before enclosing concealed installations.
 - 2. Mark the Contract Drawings and Shop Drawings completely and accurately. Use personnel proficient at recording graphic information in production of marked-up record prints.
 - 3. Mark record sets with erasable, red-colored pencil. Use other colors to distinguish between changes for different categories of the Work at same location.
 - 4. Note Addenda, Construction or Work Change Directive numbers, alternate numbers, Change Order numbers, and similar identification, where applicable.
- B. Record Digital Data Files: Immediately before inspection for Certificate of Substantial Completion, review marked-up record prints with Engineer. When authorized, prepare a full set of corrected digital data files of the Contract Drawings, as follows:
 - 1. Format: Annotated PDF electronic file with comment function enabled.

2. Incorporate changes and additional information previously marked on record prints. Delete, redraw, and add details and notations where applicable.
 3. Refer instances of uncertainty to Engineer for resolution.
 4. Engineer will furnish Contractor one set of digital data files of the Contract Drawings for use in recording information.
- C. Format: Identify and date each record Drawing; include the designation "PROJECT RECORD DRAWING" in a prominent location.
1. Record Prints: Organize record prints and newly prepared record Drawings into manageable sets. Bind each set with durable paper cover sheets. Include identification on cover sheets.
 2. Format: Annotated PDF electronic file with comment function enabled.
 3. Record Digital Data Files: Organize digital data information into separate electronic files that correspond to each sheet of the Contract Drawings. Name each file with the sheet identification. Include identification in each digital data file.
 4. Identification: As follows:
 - a. Project name.
 - b. Date.
 - c. Designation "PROJECT RECORD DRAWINGS."
 - d. Name of Engineer.
 - e. Name of Contractor.

2.2 RECORD SPECIFICATIONS

- A. Preparation: Mark Specifications to indicate the actual product installation where installation varies from that indicated in Specifications, addenda, and contract modifications.
1. Give particular attention to information on concealed products and installations that cannot be readily identified and recorded later.
 2. Mark copy with the proprietary name and model number of products, materials, and equipment furnished, including substitutions and product options selected.
 3. Record the name of manufacturer, supplier, Installer, and other information necessary to provide a record of selections made.
 4. Note related Change Orders, record Product Data, and record Drawings where applicable.
- B. Format: Submit record Specifications as annotated PDF electronic file or scanned PDF electronic file(s) of marked-up paper copy of Specifications.

2.3 RECORD PRODUCT DATA

- A. Preparation: Mark Product Data to indicate the actual product installation where installation varies substantially from that indicated in Product Data submittal.
1. Give particular attention to information on concealed products and installations that cannot be readily identified and recorded later.
 2. Include significant changes in the product delivered to Project site and changes in manufacturer's written instructions for installation.
 3. Note related Change Orders and record Drawings where applicable.
- B. Format: Submit record Product Data as annotated PDF electronic file or scanned PDF electronic file(s) of marked-up paper copy of Product Data.

2.4 MISCELLANEOUS RECORD SUBMITTALS

- A. Assemble miscellaneous records required by other Specification Sections for miscellaneous record keeping and submittal in connection with actual performance of the Work. Bind or file miscellaneous records and identify each, ready for continued use and reference.

- B. Format: Submit miscellaneous record submittals as PDF electronic file or scanned PDF electronic file(s) of marked-up miscellaneous record submittals.

PART 3 - EXECUTION

3.1 RECORDING AND MAINTENANCE

- A. Recording: Maintain one copy of each submittal during the construction period for project record document purposes. Post changes and revisions to project record documents as they occur; do not wait until end of Project.
- B. Maintenance of Record Documents and Samples: Store record documents and Samples in the field office apart from the Contract Documents used for construction. Do not use project record documents for construction purposes. Maintain record documents in good order and in a clean, dry, legible condition, protected from deterioration and loss. Provide access to project record documents for 's reference during normal working hours.

END OF SECTION 01 78 39

SECTION 01 79 00 - DEMONSTRATION AND TRAINING

PART 1 - GENERAL

1.1 SUMMARY

- A. Section includes administrative and procedural requirements for instructing Owner's personnel, including the following:
 - 1. Demonstration of operation of systems, subsystems, and equipment.
 - 2. Training in operation and maintenance of systems, subsystems, and equipment.
 - 3. Demonstration and training video recordings.

1.2 INFORMATIONAL SUBMITTALS

- A. Instruction Program: Submit outline of instructional program for demonstration and training, including a list of training modules and a schedule of proposed dates, times, length of instruction time, and instructors' names for each training module. Include learning objective and outline for each training module.
 - 1. Indicate proposed training modules using manufacturer-produced demonstration and training video recordings for systems, equipment, and products in lieu of video recording of live instructional module.

1.3 CLOSEOUT SUBMITTALS

- A. Demonstration and Training Video Recordings: Submit two copies within seven days of end of each training module.
 - 1. At completion of training, submit complete training manual(s) for Owner's use in PDF electronic file format on compact disc.

1.4 QUALITY ASSURANCE

- A. Facilitator Qualifications: A firm or individual experienced in training or educating maintenance personnel in a training program similar in content and extent to that indicated for this Project, and whose work has resulted in training or education with a record of successful learning performance.
- B. Instructor Qualifications: A factory-authorized service representative, complying with requirements in Section 01 40 00 "Quality Requirements," experienced in operation and maintenance procedures and training.

1.5 COORDINATION

- A. Coordinate instruction schedule with Owner's operations. Adjust schedule as required to minimize disrupting Owner's operations and to ensure availability of Owner's personnel.
- B. Coordinate content of training modules with content of approved emergency, operation, and maintenance manuals. Do not submit instruction program until operation and maintenance data has been reviewed and approved by Engineer.

PART 2 - PRODUCTS

2.1 INSTRUCTION PROGRAM

- A. Program Structure: Develop an instruction program that includes individual training modules for each system and for equipment not part of a system, as required by individual Specification Sections.
- B. Training Modules: Develop a learning objective and teaching outline for each module. Include a description of specific skills and knowledge that participant is expected to master. For each module, include instruction for the following as applicable to the system, equipment, or component:
1. Basis of System Design, Operational Requirements, and Criteria: Include the following:
 - a. System, subsystem, and equipment descriptions.
 - b. Performance and design criteria if Contractor is delegated design responsibility.
 - c. Operating standards.
 - d. Regulatory requirements.
 - e. Equipment function.
 - f. Operating characteristics.
 - g. Limiting conditions.
 - h. Performance curves.
 2. Documentation: Review the following items in detail:
 - a. Emergency manuals.
 - b. Operations manuals.
 - c. Maintenance manuals.
 - d. Project record documents.
 - e. Identification systems.
 - f. Warranties and bonds.
 - g. Maintenance service agreements and similar continuing commitments.
 3. Emergencies: Include the following, as applicable:
 - a. Instructions on meaning of warnings, trouble indications, and error messages.
 - b. Instructions on stopping.
 - c. Shutdown instructions for each type of emergency.
 - d. Operating instructions for conditions outside of normal operating limits.
 - e. Sequences for electric or electronic systems.
 - f. Special operating instructions and procedures.
 4. Operations: Include the following, as applicable:
 - a. Startup procedures.
 - b. Equipment or system break-in procedures.
 - c. Routine and normal operating instructions.
 - d. Regulation and control procedures.
 - e. Control sequences.
 - f. Safety procedures.
 - g. Instructions on stopping.
 - h. Normal shutdown instructions.
 - i. Operating procedures for emergencies.
 - j. Operating procedures for system, subsystem, or equipment failure.
 - k. Seasonal and weekend operating instructions.
 - l. Required sequences for electric or electronic systems.
 - m. Special operating instructions and procedures.
 5. Adjustments: Include the following:
 - a. Alignments.
 - b. Checking adjustments.
 - c. Noise and vibration adjustments.
 - d. Economy and efficiency adjustments.
 6. Troubleshooting: Include the following:

- a. Diagnostic instructions.
- b. Test and inspection procedures.
- 7. Maintenance: Include the following:
 - a. Inspection procedures.
 - b. Types of cleaning agents to be used and methods of cleaning.
 - c. List of cleaning agents and methods of cleaning detrimental to product.
 - d. Procedures for routine cleaning
 - e. Procedures for preventive maintenance.
 - f. Procedures for routine maintenance.
 - g. Instruction on use of special tools.
- 8. Repairs: Include the following:
 - a. Diagnosis instructions.
 - b. Repair instructions.
 - c. Disassembly; component removal, repair, and replacement; and reassembly instructions.
 - d. Instructions for identifying parts and components.
 - e. Review of spare parts needed for operation and maintenance.

PART 3 - EXECUTION

3.1 PREPARATION

- A. Assemble educational materials necessary for instruction, including documentation and training module. Assemble training modules into a training manual organized in coordination with requirements in Section 01 78 23 "Operation and Maintenance Data."

3.2 INSTRUCTION

- A. Facilitator: Engage a qualified facilitator to prepare instruction program and training modules, to coordinate instructors, and to coordinate between Contractor and Owner for number of participants, instruction times, and location.
- B. Engage qualified instructors to instruct Owner's personnel to adjust, operate, and maintain systems, subsystems, and equipment not part of a system.
 - 1. Engineer will furnish an instructor to describe basis of system design, operational requirements, criteria, and regulatory requirements.
 - 2. Owner will furnish Contractor with names and positions of participants.
- C. Scheduling: Provide instruction at mutually agreed on times. For equipment that requires seasonal operation, provide similar instruction at start of each season.
 - 1. Schedule training with Owner, through Engineer, with at least seven days' advance notice.
- D. Training Location and Reference Material: Conduct training on-site in the completed and fully operational facility using the actual equipment in-place. Conduct training using final operation and maintenance data submittals.

END OF SECTION 01 79 00

SECTION 02 01 10 - CONCRETE RESERVOIR MAINTENANCE

PART 1 - GENERAL

1.1 SCOPE

- A. This section covers the dewatering, cleaning and removal of sludge and debris from the tertiary filter clear wells.
- B. These areas are classified as permit entry confined spaces. All work within the clear well shall be classified as confined space work. Flammable materials shall not be stored or located in the clear wells. All hazardous gases shall be safely removed prior to ventilation. Clear wells shall be continuously ventilated, and the atmosphere in the clear wells monitored using approved detection devices, at all times. The Contractor shall treat the tank as a confined, hazardous space at all times.
- C. The Contractor shall provide all equipment, pumps, hoses, lights, electrical extension cords, all temporary power, tools, and labor required to remove clear well content, beyond what the existing plant effluent pumps can remove. It is estimated that the pumps can remove all but 4-inches depth of tertiary effluent from the clear wells.
- D. The WWTP Plant will provide a fire hydrant available for the Contractor's use during the project. Usage shall not exceed 50 gallons per minute. Water from the WWTP site fire hydrants is plant effluent water prior to disinfection.
- E. All hauling and handling equipment and labor shall be provided by Contractor. Hauling equipment shall not permit sludge to leak or splash onto roads during loading or transportation. Contractor shall be responsible for cleaning up any spilled, leaked, or splashed sludge on roads or other areas at or away from the site of Work. The landfill or permitted disposal site shall be identified and manifests and testing shall be submitted to the Owner and Engineer for record purposes.
- F. Material removed from the clear wells shall be dewatered and treated as required to be transported to a licensed/permitted landfill or permitted disposal site. Dewatering shall not produce excessive odors, require excess operating area or otherwise be completed in a manner which would impede plant operations.
- G. Contractor shall dispose of all clear well contents on a land disposal site permitted by the State. Contractor shall locate the disposal site, arrange for disposal, and acquire permission to dispose of clear well contents. The disposal site shall be permitted to handle the grade of material removed from the clear well or Contractor shall be permitted to dispose of the grade of material on a designated site. Contractor shall comply with all state, local, and federal regulations concerning removal, hauling, and disposal of sludge contents.

1.2 Related requirements specified elsewhere

- A. Section 03 01 30 – Maintenance of Cast-In-Place Concrete.
- B. Section 03 15 00 - Concrete Accessories.
- C. Section 03 30 00 – Cast-In-Place Concrete.
- D. Section 09 20 00 – Facility Painting.

- E. Section 46 51 46 – Membrane Diffusers.
- F. The scope of this contract includes the cleaning and removal of all clear well contents, high pressure cleaning of the interior clear well walls, floor, ceiling, covers, etc with a high pressure hose nozzle and broom, cleaning of all associated piping and valves, hauling of all contents removed from clear wells.
- G. Contractor work includes cleaning out any materials impacted inside the tank. Clear well contents refer to all material including sludge, solids, liquids, leakage through valves in pipelines connected to other clear wells, and leakage or water from other sources.
- H. Once the Clear wells are cleaned to the satisfaction of the Engineer and City. The Engineer and Contractor will assess the condition of the clearwell and identify crack repairs noted for repair. Additional crack repair work may be required and will be paid for by the unit price work cost for that item.
- I. Contractor shall maintain a clean work environment on a daily basis. Anything attracting vectors shall be cleaned up immediately. Contractor shall clean up any sludge or clear well contents spilled on the ground or splashed on the walls after each clear well is emptied. Clean-up is required of any stains or clear well contents from the work area.

1.3 FINAL CLEANING OF TANK INTERIORS

- A. The scope of this contract includes the cleaning and removal of all clear well contents, high pressure cleaning of the interior clear well walls, floor, ceiling, covers, etc with a high pressure hose nozzle and broom, cleaning of all associated piping and valves, hauling of all contents removed from clear wells. The use of pressure wash is permitted to pressures below 500 psi. Care shall be taken to prevent damaging concrete surfaces and all other appurtenances. Any damage to the concrete surfaces and appurtenances shall be repaired in a manner satisfactory to the Engineer Manager and at no additional cost to the Contract. Leave the tank and appurtenances in a complete and finished condition to the satisfaction of the Engineer.
- B. Contractor work includes cleaning out any materials impacted inside the tank. Clear well contents refer to all material including sludge, solids, liquids, leakage through valves in pipelines connected to other clear wells, and leakage or water from other sources.
- C. Conduct cleaning operations in a manner to prevent the infiltration of foreign water or substances into the reservoir.
- D. Properly dispose of all debris, including accumulated filter media, dirt, sand, gravel, rubbish, waste material, masonry baffle walls and construction debris in accordance with all applicable regulations and at no additional cost to the contract.
- E. Use clean potable water free of minerals which would cause staining, or which would react chemically with the concrete. The Owner will provide a source of water for use by the Contractor. The discriminate use of unmetered Owner-supplied water for concrete cleaning will be at no cost to the Contractor. Contractor to provide approved backflow preventers at all connections to potable water sources used in cleaning and construction.
- F. Once the clear wells are cleaned to the satisfaction of the Engineer and City. The Engineer and Contractor will assess the condition of the clearwell and identify crack repairs noted for repair. Additional crack repair work may be required and will be paid for by the unit price work cost for that item.

G. Contractor shall maintain a clean work environment on a daily basis. Anything attracting vectors shall be cleaned up immediately. Contractor shall clean up any sludge or clear well contents spilled on the ground or splashed on the walls after each clear well is emptied. Clean-up is required of any stains or clear well contents from the work area.

1. .

H. Employ experienced workers, or professional cleaners, for cleaning.

I. Use only cleaning materials recommended by manufacturer of surface to be cleaned.

J. Repair, patch, and touch up marred surfaces to specified finish, to match adjacent surfaces.

K. Handle materials in a controlled manner with as few handlings as possible. Do not drop or throw materials from heights.

L. Schedule cleaning operations so that dust and other contaminants resulting from cleaning process will not fall on wet, newly painted surfaces.

M. Remove and dispose of all water, dirt, rubbish or any other foreign substances.

1.4 INSPECTION OF RESERVOIR INTERIOR

A. After cleaning is complete and prior to returning to operation by the Owner, the final interior inspection may be scheduled. The inspection will be done with the Engineer.

PART 2 - PRODUCTS – (Not Used)

PART 3 - EXECUTION (Not Used)

END OF SECTION 02 01 10

SECTION 02 41 19024119 - SELECTIVE DEMOLITION

PART 1 - GENERAL

1.1 SUMMARY

A. Section Includes:

1. Demolition and removal of selected portions of building or structure.
2. Demolition and removal of selected site elements including equipment and appurtenances.

B. Related Requirements:

1. Section 01 10 00 "Summary" for restrictions on use of the premises, Owner-occupancy requirements, and phasing requirements.
2. Section 01 73 00 "Execution" for cutting and patching procedures.

1.2 DEFINITIONS

- A. Remove: Detach items from existing construction and dispose of them off-site unless indicated to be salvaged or reinstalled.
- B. Remove and Salvage: Detach items from existing construction, in a manner to prevent damage, and deliver to Owner ready for storage.
- C. Remove and Reinstall: Detach items from existing construction, in a manner to prevent damage, prepare for reuse, and reinstall where indicated.
- D. Existing to Remain: Leave existing items that are not to be removed and that are not otherwise indicated to be salvaged or reinstalled. Items to be protected during demolition and construction activities.
- E. Dismantle: To remove by disassembling or detaching an item from a surface, using gentle methods and equipment to prevent damage to the item and surfaces; disposing of items unless indicated to be salvaged or reinstalled.

1.3 MATERIALS OWNERSHIP

- A. Unless otherwise indicated, demolition waste becomes property of Contractor.

1.4 PREINSTALLATION MEETINGS

A. Predemolition Conference: Conduct conference at Project site.

1. Contractor's operations shall be limited to the Tertiary Filter Building Area.
2. Inspect and discuss condition of construction to be selectively demolished.
3. Review structural load limitations of existing structure.
4. Review and finalize selective demolition schedule and verify availability of materials, demolition personnel, equipment, and facilities needed to make progress and avoid delays.
5. Review requirements of work performed by other trades that rely on substrates exposed by selective demolition operations.
6. Review areas where existing construction is to remain and requires protection.
7. Review staging and access requirements.

1.5 INFORMATIONAL SUBMITTALS

- A. Proposed Protection Measures: Submit report, including Drawings, that indicates the measures proposed for protecting individuals and property, for dust control and, for noise control. Indicate proposed locations and construction of barriers.
 - 1. Protect clear wells during each phase of construction clear wells shall be thoroughly cleaned and inspected prior to returning to operation.
 - 2. Operating filters shall be protected at all times from debris and dust settling within the filter units.
 - 3. Protect existing equipment, piping, valves, supports, pumps, motors, guardrail, lighting, receptacles, conduit, level floats and sensors, doors, windows, stairways, and other miscellaneous items and architectural features within the Filter Building and filter cells not shown to be removed or replaced.
 - 4. Monitor ground water elevation and notify Engineer if ground water elevation exceeds elevation 732.0.
- B. Schedule of Selective Demolition Activities: Indicate the following:
 - 1. Detailed sequence of selective demolition and removal work, with starting and ending dates for each activity. Ensure Owner's on-site operations are uninterrupted.
 - 2. Interruption of utility services. Indicate how long utility services will be interrupted.
 - 3. Coordination for shutoff, capping, and continuation of utility services.
 - 4. Coordination of Owner's continuing occupancy of portions of existing building and of Owner's partial occupancy of completed Work.
- C. Predemolition Video: Show existing conditions of adjoining construction, including finish surfaces, that might be misconstrued as damage caused by demolition operations. Comply with Section 01 32 33 "Photographic Documentation." Submit before Work begins.
- D. Warranties: Documentation indicating that existing warranties are still in effect after completion of selective demolition.

1.6 FIELD CONDITIONS

- A. Owner will occupy portions of building within the selective demolition area. Conduct selective demolition so Owner's operations will not be disrupted.
- B. Notify Engineer of discrepancies between existing conditions and Drawings before proceeding with selective demolition.
- C. Hazardous Materials: It is not expected that hazardous materials will be encountered in the Work.
 - 1. If suspected hazardous materials are encountered, do not disturb; immediately notify Engineer and Owner. Hazardous materials will be removed by Owner under a separate contract.
- D. Storage or sale of removed items or materials on-site is not permitted.
- E. Utility Service: Maintain existing utilities indicated to remain in service and protect them against damage during selective demolition operations.
 - 1. Maintain fire-protection facilities in service during selective demolition operations.

1.7 COORDINATION

- A. Arrange selective demolition schedule with the Engineer and the Owner so as not to interfere with Owner's operations.

PART 2 - PRODUCTS

2.1 PERFORMANCE REQUIREMENTS

- A. Regulatory Requirements: Comply with governing EPA notification regulations before beginning selective demolition. Comply with hauling and disposal regulations of authorities having jurisdiction.
- B. Standards: Comply with ASSE A10.6 and NFPA 241.

PART 3 - EXECUTION

3.1 EXAMINATION

- A. Verify that utilities have been disconnected and capped before starting selective demolition operations.
- B. Review Project Record Documents of existing construction or other existing condition information provided by Owner. Owner does not guarantee that existing conditions are same as those indicated in Project Record Documents.
- C. Survey of Existing Conditions: Record existing conditions by use of preconstruction video.
 - 1. Comply with requirements specified in Section 01 32 33 "Photographic Documentation."
 - 2. Before selective demolition or removal of existing building elements that will be reproduced or duplicated in final Work, make permanent record of measurements, materials, and construction details required to make exact reproduction.

3.2 UTILITY SERVICES AND MECHANICAL/ELECTRICAL SYSTEMS

- A. Existing Services/Systems to Remain: Maintain existing services/systems and protect them against damage. Items shall remain unless indicated for removal.
- B. Existing Services/Systems to Be Removed, Relocated, or Abandoned: Locate, identify, disconnect, and seal or cap off utility services and mechanical/electrical systems serving areas to be selectively demolished.
 - 1. Owner will arrange to shut off indicated services/systems when requested by Contractor.
 - 2. If services/systems are required to be removed, relocated, or abandoned, provide temporary services/systems that bypass area of selective demolition and that maintain continuity of services/systems to other parts of building.
 - 3. Disconnect, demolish, and remove plumbing, equipment, and components indicated on Drawings to be removed.
 - a. Piping to Be Removed: Remove portion of piping indicated to be removed and cap or plug remaining piping with same or compatible piping material.
 - b. Piping to Be Abandoned in Place: Drain piping and cap or plug piping with same or compatible piping material and leave in place.
 - c. Equipment to Be Removed: Disconnect and cap services and remove equipment.
 - d. Equipment to Be Removed and Reinstalled: Disconnect and cap services and remove, clean, and store equipment; when appropriate, reinstall, reconnect, and make equipment operational.

3.3 PROTECTION

- A. Temporary Protection: Provide temporary barricades and other protection required to prevent injury to people and damage to adjacent buildings and facilities to remain.

1. Provide protection to ensure safe passage of people around selective demolition area and to and from occupied portions of building.
 2. Provide temporary weather protection, during interval between selective demolition of existing construction on exterior surfaces and new construction, to prevent water leakage and damage to structure and interior areas.
 3. Protect walls, ceilings, floors, and other existing finish work that are to remain or that are exposed during selective demolition operations.
 4. Cover and protect equipment that has not been removed.
 5. Comply with requirements for temporary enclosures, dust control, lighting, ventilation, heating, and cooling specified in Section 01 50 00 "Temporary Facilities and Controls."
- B. Temporary Shoring: Design, provide, and maintain shoring, bracing, and structural supports as required to preserve stability and prevent movement, settlement, or collapse of construction and finishes to remain, and to prevent unexpected or uncontrolled movement or collapse of construction being demolished.
1. Strengthen or add new supports when required during progress of selective demolition.
- C. Remove temporary barricades and protections where hazards no longer exist.

3.4 SELECTIVE DEMOLITION, GENERAL

- A. General: Demolish and remove existing construction only to the extent required by new construction and as indicated. Use methods required to complete the Work within limitations of governing regulations and as follows:
1. Proceed with selective demolition systematically, from higher to lower level. Complete selective demolition operations above each floor or tier before disturbing supporting members on the next lower level.
 2. Neatly cut openings and holes plumb, square, and true to dimensions required. Use cutting methods least likely to damage construction to remain or adjoining construction. Use hand tools or small power tools designed for sawing or grinding, not hammering and chopping. Temporarily cover openings to remain.
 3. Cut or drill from the exposed or finished side into concealed surfaces to avoid marring existing finished surfaces.
 4. Do not use cutting torches until work area is cleared of flammable materials. At concealed spaces, such as duct and pipe interiors, verify condition and contents of hidden space before starting flame-cutting operations. Maintain portable fire-suppression devices during flame-cutting operations.
 5. Maintain fire watch during flame cutting, and for at least 2 hours after flame-cutting operations have been completed.
 6. Maintain adequate ventilation when using cutting torches.
 7. Remove decayed, vermin-infested, or otherwise dangerous or unsuitable materials and promptly dispose of off-site.
 8. Remove structural framing members and lower to ground by method suitable to avoid free fall and to prevent ground impact or dust generation.
 9. Locate selective demolition equipment and remove debris and materials so as not to impose excessive loads on supporting walls, floors, or framing.
 10. Dispose of demolished items and materials promptly offsite by approved methods.
- B. Site Access and Temporary Controls: Conduct selective demolition and debris-removal operations to ensure minimum interference with roads, streets, walks, walkways, and other adjacent occupied and used facilities.
- C. Removed and Reinstalled Items:
1. Clean and repair items to functional condition adequate for intended reuse.
 2. Pack or crate items after cleaning and repairing. Identify contents of containers.
 3. Protect items from damage during transport and storage.

4. Reinstall items in locations indicated. Comply with installation requirements for new materials and equipment. Provide connections, supports, and miscellaneous materials necessary to make item functional for use indicated.

D. Existing Items to Remain: Protect construction indicated to remain against damage and soiling during selective demolition. When permitted by Architect, items may be removed to a suitable, protected storage location during selective demolition and cleaned and reinstalled in their original locations after selective demolition operations are complete.

3.5 SELECTIVE DEMOLITION PROCEDURES FOR SPECIFIC MATERIALS

A. Through Wall Piping and Sleeves: Demolish in small sections. Using power-driven saw, cut concrete to a depth of at least 3/4 inch at junctures with construction to remain. Dislodge concrete from reinforcement at perimeter of areas being demolished, cut reinforcement, and then remove remainder of concrete. Neatly trim openings to dimensions indicated. Patch concrete as required and approved by Engineer.

B. Concrete cracks: Concrete cracks or patching created by demolition activities shall be repaired in accordance with the Contract Documents at no additional change in Contract Amount.

C. Masonry Baffle Walls:

1. The Owner will drain clear wells, to the best of the existing equipment capabilities, upon notification by Contractor.
2. Contractor shall be responsible for cleaning clear wells prior to demolition activities.
3. Masonry baffle walls to be removed in an orderly manner without damage to existing concrete structures to remain. Vertical reinforcements to be cut a minimum of 1" below finished surfaces of floors and ceilings. Repair areas in accordance with Contract Documents.
4. Upon removal of the baffle wall and cleaning of the surfaces, the existing concrete tank slab, walls, and ceilings will be inspected by Engineer for concrete crack repair. Contractor will be responsible for all fees associated with the drying, dewatering, testing and off-site hauling and disposal of demolition debris to an appropriate disposal facility.
5. Testing should be coordinated by Contractor with disposal landfill and their testing requirements.

3.6 DISPOSAL OF DEMOLISHED MATERIALS

A. Remove demolition waste materials from Project site and dispose of them in an EPA-approved construction and demolition waste landfill acceptable to authorities having jurisdiction.

1. Do not allow demolished materials to accumulate on-site.
2. Remove and transport debris in a manner that will prevent spillage on adjacent surfaces and areas.
3. Remove debris from elevated portions of building by chute, hoist, or other device that will convey debris to grade level in a controlled descent.

B. Burning: Do not burn demolished materials.

3.7 CLEANING

A. Clean adjacent structures and improvements of dust, dirt, and debris caused by selective demolition operations. Return adjacent areas to condition existing before selective demolition operations began.

3.8 SELECTIVE DEMOLITION SCHEDULE

A. Remove:

1. Air piping and supports in Filter gallery.
2. Air piping, Sanitaire D24 diffusers and supports in Clear Wells.
3. Air piping in Filter Gallery.
4. PVC chlorine solution piping in Clear Wells and Filter Gallery.
5. PVC Sample Piping and supports in Clear Wells and Filter Gallery.
6. Masonry baffle walls.
7. Select pressure relief valves clear well floor slabs as identified by Engineer.

B. Existing to Remain:

1. Tertiary Filter Effluent piping.
2. Pump Suction Piping
3. Cross Connection piping
4. Effluent weir walls.
5. Level measurement devices.
6. All building architectural components.
7. Select pressure relief valves in clear well floor slabs as identified by Engineer.

END OF SECTION 02 41 19024119

SECTION 03 01 30 - MAINTENANCE OF CAST-IN-PLACE CONCRETE

PART 1 - GENERAL

1.1 SUMMARY

- A. Section Includes:
 - 1. Removal of deteriorated concrete and subsequent patching.
 - 2. Polyurethane grout injection.
 - 3. Polymer sealers.

- B. Related Sections:
 - 1. Section 01 10 00 – Summary
 - 2. Section 01 22 00 – Unit Prices
 - 3. Section 02 41 19 – Concrete Reservoir Maintenance

1.2 PREINSTALLATION MEETINGS

- A. Pre-installation Conference: Conduct conference at Project site.

1.3 ACTION SUBMITTALS

- A. Product Data: For each type of product.

- B. Samples: Cured Samples for each exposed product and for each color and texture specified.

1.4 INFORMATIONAL SUBMITTALS

- A. Material certificates.

- B. Product test reports.

- C. Field quality-control reports.

1.5 QUALITY ASSURANCE

- A. Concrete-Maintenance Specialist Qualifications: Engage an experienced concrete-maintenance firm that employs installers and supervisors who are trained and approved by manufacturer to apply packaged patching-mortar, polyurethane grout, crack-injection adhesive and polymer sealers to perform work of this Section. Firm shall have completed work similar in material, design, and extent to that indicated for this Project with a record of successful in-service performance. Experience in only installing or patching new concrete is insufficient experience for concrete-maintenance work.

- B. Submit project references documenting compliance with experience requirements. Provide evidence of training and manufacturer's certification of installers.

PART 2 - PRODUCTS

2.1 MANUFACTURERS

- A. Source Limitations: For repair products, obtain each color, grade, finish, type, and variety of product from single source and from single manufacturer with resources to provide products of consistent quality in appearance and physical properties as listed below.

2.2 CRACK SEALER

- A. For sealing wall cracks prior to epoxy injection and reseal of control/construction joints: ConSeal CS-1500
 - 1. Manufacturer: ConSeal, 1-800-332-7325, www.conseal.com

2.3 URETHANE CRACK FILLER

- A. For injection of wall cracks smaller than 1/8": Prime Flex 920
 - 1. Manufacturer: Prime Resins, 1-800-321-7212, www.primeresins.com

2.4 BONDING AGENTS

- A. For bonding new concrete to old: SikaDur 32, Hi-Mod
 - 1. Manufacturer: Sika, 1-800-933-7452, usa.sika.com.

2.5 POLYMER MODIFIED REPAIR MORTAR

- A. For vertical and overhead large concrete patching: SikaQuick VOH
 - 1. Manufacturer: Sika Corporation, 1-800-933-7452, usa.sika.com.

2.6 MISCELLANEOUS MATERIALS

- A. Portland Cement: ASTM C 150/C 150M, Type I, II, or III unless otherwise indicated.
- B. Slab Topping crystalline admixture: Xypex C-500 or C-500 NF additive (or equal).
- C. Water: Potable.

2.7 MIXES

- A. General: Mix products, in clean containers, according to manufacturer's written instructions.
- B. Dry-Pack Mortar: Mix required type(s) of patching-mortar dry ingredients with just enough liquid to form damp cohesive mixture that can be squeezed by hand into a ball but is not plastic.

PART 3 - EXECUTION

3.1 CONCRETE MAINTENANCE

- A. Have concrete-maintenance work performed only by qualified concrete-maintenance specialist.
- B. Comply with manufacturers' written instructions for surface preparation and product application.

3.2 EXAMINATION

- A. Notify Architect seven days in advance of dates for installation of products in this section.
- B. Perform surveys as the Work progresses to detect hazards resulting from concrete-maintenance work.

3.3 PREPARATION

- A. Ensure that supervisory personnel are on-site and on duty when concrete maintenance work begins and during its progress.
- B. Protect persons, motor vehicles, surrounding surfaces of structure being repaired, building site, plants, and surrounding buildings from harm resulting from concrete maintenance work.
 - 1. Comply with each product manufacturer's written instructions for protections and precautions.
 - 2. Contain dust and debris generated by concrete maintenance work and prevent it from reaching the public or adjacent surfaces.
 - 3. Protect floors and other surfaces along haul routes from damage, wear, and staining.
 - 4. Provide supplemental sound-control treatment to isolate removal and dismantling work from other areas of the structure.
 - 5. Neutralize and collect alkaline and acid wastes for disposal off Owner's property.
- C. Preparation for Concrete Removal: Make explorations, probes, and inquiries as necessary to determine condition of construction to be removed in the course of repair.
 - 1. Verify that affected utilities have been disconnected and capped.
 - 2. Provide and maintain shoring, bracing, and temporary structural supports as required to preserve stability and prevent unexpected or uncontrolled movement, settlement, or collapse of construction being demolished and construction and finishes to remain. Strengthen or add new supports when required during progress of removal work.
- D. Reinforcing-Bar Preparation: Remove loose and flaking rust from exposed reinforcing bars by high-pressure water cleaning, abrasive blast cleaning, needle scaling, or wire brushing until only tightly adhered light rust remains. (add the commas here)
 - 1. Where section loss of reinforcing bar is more than 25 percent, or 20 percent in two or more adjacent bars, cut bars and remove and replace as indicated on Drawings.
 - 2. Remove additional concrete as necessary to provide at least 3/4-inch clearance at existing and replacement bars.
 - 3. Splice replacement bars to existing bars according to ACI 318 by lapping, welding, or using mechanical couplings.
- E. Preparation of Floor, Ceiling or Wall Joints for Repair: Saw-cut joints full width to edges and depth of spalls, or as indicated on the drawings but not less than 2 inches deep. Clean out debris and loose concrete; vacuum or blow clear with compressed air.

3.4 CONCRETE REMOVAL

- A. Do not overload structural elements with debris.
- B. Remove deteriorated and delaminated concrete by lightweight jackhammering methods. Protect existing concrete to remain from demolition operations.
- C. Sawcut areas of full depth removal and jackhammer or break up concrete while salvaging existing reinforcement. Sawcut cracks for repairs as shown on the drawings.

- D. Remove additional concrete if necessary, to provide a depth of removal of at least 1/2 inch over entire removal area.
- E. Where half or more of the perimeter of reinforcing bar is exposed, bond between reinforcing bar and surrounding concrete is broken, or reinforcing bar is corroded, remove concrete from entire perimeter of bar and to provide at least 3/4-inch clearance around bar.
- F. Test areas where concrete has been removed by tapping with hammer and remove additional concrete until unsound and disbonded concrete is completely removed.
- G. Provide surfaces with a fractured profile of at least 1/8 inch that are approximately perpendicular or parallel to original concrete surfaces.
- H. Thoroughly clean removal areas of loose concrete, dust, and debris.
- I. Contact ENGINEER for inspection once concrete demolition is complete.

3.5 BONDING AGENT APPLICATION

- A. Clean and prepare concrete thoroughly as required by the manufacturer prior to installation of the bonding agent. Surface roughness and concrete dampness requirements for product installation shall be adhered to.
- B. Place product on concrete surface, sides and reinforcement per manufacturer's recommendations prior to pouring concrete topping. Product shall not be allowed to set past the recommended time for proper adhesion to the fresh concrete.

3.6 CONSTRUCTION/CONTROL JOINT REPAIR/SEAL (Repair Detail R2)

- A. Remove any vegetation prior to crack cleaning.
- B. Clean cracks with oil-free compressed air or low-pressure water to remove loose particles.
- C. Clean areas to receive elastomeric seal of oil, dirt, and other substances that would interfere with bond.
- D. Place Elastomeric sealant in accordance with manufacturer's instruction.

3.7 URETHANE CRACK FILLER INSTALLATION (Repair Detail R16)

- A. Remove any vegetation prior to crack cleaning.
- B. Clean cracks with oil-free compressed air or low-pressure water to remove loose particles.
- C. Drill injection holes as required per the manufacturer's recommendations.
- D. Install crack filler by injection method at locations shown on the drawings.
- E. Remove excess product from concrete surfaces.

3.8 POLYMER-MODIFIED REPAIR MORTAR INSTALLATION (Repair Detail R10)

- A. Remove loose debris, deteriorated concrete, and bond-inhibitive materials by water blast or other approved mechanical means.

- B. Surfaces and exposed aggregate to receive patching material shall be scarified to obtain an aggregate surface profile of +/- 1/16".
- C. Sawcut exposed edges where possible.
- D. Apply repair mortar to vertical surfaces in maximum 3" lifts: and to overhead surfaces in maximum 2" lifts.

3.9 FIELD QUALITY CONTROL

- A. Testing Agency: Contractor to provide an independent qualified testing agency to perform tests and inspections as approved by Engineer.
- B. Perform the following tests and inspections:
 - 1. Epoxy Crack Injection: Core-drilled samples to verify proper installation.
 - a. Testing Frequency: Two samples total along crack injected.
 - b. Where samples are taken, refill holes with epoxy mortar.
- C. Product will be considered defective if it does not pass tests and inspections.
- D. Prepare test and inspection reports.

END OF SECTION 03 01 30

SECTION 03 15 00 - CONCRETE ACCESSORIES

PART 1 - GENERAL

1.1 SUMMARY

A. Section Includes:

1. Cast-in and drilled in anchors for concrete.
2. Anchors, including wedge, sleeve, undercut and adhesive type.
3. Epoxy bonding agent between vertical concrete pours.

B. Related Sections:

1. Division 01 31 00 - Project Management and Coordination: Requirements for coordination.
2. Division 3 Concrete Sections.
3. Division 46 Diffuser Equipment.
4. Coordinate Work of this Section with piping and equipment connections as specified in other Sections and as indicated on Drawings.

1.2 SUBMITTALS

A. General: Submit in accordance with Conditions of the Contract and Division 01 33 00 - Submittal Procedures.

1. Product specifications with recommended design values and physical characteristics for epoxy dowels, expansion and undercut anchors.
2. Samples: Representative length and diameters of each type anchor shown on the Drawings.
3. Quality Assurance Submittals:
 - a. Test Reports: Certified test reports showing compliance with specified performance characteristics and physical properties.
 - b. Certificates:
 - 1) ICC ES Evaluation Reports.
4. Manufacturer's installation instructions.

B. Closeout Submittals: Submit the following:

1. Record Documents: Project record documents for installed materials in accordance with Division 1 Closeout Submittals Section.

1.3 QUALITY ASSURANCE

A. Installer Qualifications:

B. Drilled-in anchors shall be installed by a contractor with at least three years of experience performing similar installations.

C. Certifications: Unless otherwise authorized by the Engineer, anchors shall have one of the following certifications:

1. ICC ES Evaluation Report indicating conformance with current applicable ICC ES Acceptance Criteria.

1.4 DELIVERY, STORAGE AND HANDLING

A. General: Comply with Division 1 Section—Product Storage and Handling Requirements.

1. Store anchors and epoxy in accordance with manufacturer's recommendations.

PART 2 - PRODUCTS

2.1 MATERIALS

A. Fasteners and Anchors:

1. Bolts and Studs: ASTM A307; ASTM A449 where "high strength" is indicated on the Drawings.
2. Carbon and Alloy Steel Nuts: ASTM A563.
3. Carbon Steel Washers: ASTM F436.
4. Carbon Steel Threaded Rod: ASTM A36; or ASTM A193 Grade B7; or ISO 898 Class 5.8.
5. Wedge Anchors: ASTM A510; or ASTM A108.
6. Stainless Steel Bolts, Hex Cap Screws, and Studs: ASTM F593.
7. Stainless Steel Nuts: ASTM F594.
8. Zinc Plating: ASTM B633.
9. Hot-Dip Galvanizing: ASTM A153.
10. Metric Anchor Bolts, Screws, and Studs: ISO 898 Part 1.
11. Metric Anchor Nuts: EN 24033.
12. Metric Anchor Stainless Steel Bolts, Screws, and Studs: ISO 3506 Part 1.
13. Metric Anchor Stainless Steel Nuts: ISO 3506 Part 2.
14. Reinforcing Dowels: ASTM A615

B. Manufacturers: Subject to compliance with requirements, provide products by one of the following:

1. Hilti
2. Red Head
3. Simpson Strong-Tie
4. Powers Fasteners
5. Sika
6. Williams Form Engineering Corp

2.2 GENERAL REQUIREMENTS

A. Anchors Exposed to Weather, in Contact with Aluminum Components, for use with FRP, or in Submerged Conditions and Chemical Service Areas: Type 316 stainless steel, ASTM F593.

B. Anchors for All Other Conditions: Type 304, stainless steel ASTM A193.

2.3 ANCHOR BOLTS CAST-IN-PLACE CONCRETE

A. Anchors, Bolts, Nuts, and Washers: Bolts and studs, nuts, and washers shall be fabricated from AISI Type 316 stainless steel.

B. 4-inch minimum hook, unless otherwise indicated.

2.4 DRILLED-IN ANCHORS

A. Wedge Anchors: Wedge type, torque-controlled, with impact section to prevent thread damage complete with required nuts and washers. Provide anchors with length identification markings conforming to ICC ES AC01 or ICC ES AC193. Type and size as indicated on Drawings.

1. Manufacturers:

- a. Hilti Corporation, Kwik Bolt 3.
- b. Red Head, Trubolt Wedge Anchor.
- c. The Powers Rawl Company, Inc., Power-Stud+.
- d. Comply with U.S Government GSA specification A-A-1923A Type4.

2. As indicated on the Drawings, provide stainless steel anchors. Stainless steel anchors shall be AISI Type 316 stainless steel provided with stainless steel nuts and washers of matching alloy group and minimum proof stress equal to or greater than the specified minimum full-size tensile strength of the externally threaded fastener. Stainless steel nuts shall conform to ASTM F594 unless otherwise specified. Avoid installing stainless steel anchors in contact with galvanically dissimilar metals.
 3. Minimum Embedment: 4 inches, unless otherwise indicated.
- B. Screw Anchors: screw type. Pre-drilling of the hole requires a standard ANSI drill bit with the same diameter as the anchor and installing the anchor will be done with an impact wrench. Provide anchors with a diameter and anchor length marking on the head. Type and size as indicated on Drawings.
- C. Heavy Duty Sleeve Anchors: Torque-controlled, exhibiting follow-up expansion under load, with provision for rotation prevention during installation. Type and size as indicated on Drawings.
1. Manufacturers:
 - a. Hilti Corporation, Sleeve Anchor.
 - b. Red Head, Dynabolt Sleeve Anchor.
 - c. The Powers Rawl Company, Inc., Lok/Bolt.
 - d. Comply with U.S Government GSA specification A-A-55614
 2. As indicated on the Drawings, provide stainless steel anchors. Stainless steel anchors shall be manufactured from materials conforming to ISO 3506 Part 1 and having corrosion resistance equivalent to AISI Type 316 stainless steel. Stainless steel anchors shall be provided with stainless steel nuts and washers of matching alloy group and minimum proof stress equal to or greater than the specified minimum full-size tensile strength of the externally threaded fastener. All nuts shall conform to ISO 3506 Part 2 unless otherwise specified. Avoid installing stainless steel anchors in contact with galvanically dissimilar metals.
- D. Heavy Duty Undercut Anchors: Bearing-type. Installed anchor shall have a minimum tension bearing area in the concrete, measured as the horizontal projection of the bearing surface, not less than two times the net tensile area of the anchor bolt. The installed anchor shall exhibit a form fit between the bearing elements and the undercut in the concrete. Type and size as indicated on Drawings.
1. Undercut Anchors Manufacturers:
 - a. Hilti Corporation, HDA Undercut Anchor.
 - b. Minimum Embedment: 4 inches, unless otherwise indicated.
 2. As indicated on the Drawings, provide sherardized or stainless-steel anchors. Sherardized anchors shall be manufactured from materials conforming to ISO 898 Part 1 and having corrosion resistance equivalent to ASTM A153 with sherardized dry diffusion zinc coating (50 mm min.). Stainless steel anchors shall be manufactured from materials conforming to ISO 3506 Part 1 and having corrosion resistance equivalent to AISI Type 316 stainless steel. Stainless steel anchors shall be provided with stainless steel nuts and washers of matching alloy group and minimum proof stress equal to or greater than the specified minimum full-size tensile strength of the externally threaded fastener. All nuts shall conform to ISO 3506 Part 2 unless otherwise specified. Avoid installing stainless steel anchors in contact with galvanically dissimilar metals.
- E. Cartridge Injection Adhesive Anchors: Threaded steel rod, inserts or reinforcing dowels, complete with nuts, washers, epoxy, polymer or hybrid mortar adhesive injection system, and manufacturer's installation instructions. Type and size as indicated on Drawings.
1. Manufacturers:
 - a. Red Head, Epcon System, C6+.
 - b. The Powers Rawl Company, Inc., Pure110+.
 2. As indicated on the Drawings, provide stainless steel anchors. Stainless steel anchors shall be AISI Type 316 stainless steel provided with stainless steel nuts and washers of matching

alloy group and minimum proof stress equal to or greater than the specified minimum full-size tensile strength of the externally threaded fastener. All nuts shall conform to ASTM F594 unless otherwise specified. Avoid installing stainless steel anchors in contact with galvanically dissimilar metals.

3. Reinforcing dowels shall be A615 Grade 60.
4. Injection Gel:
 - a. Two component structural epoxy.
 - b. Comply with ASTM C881.
5. Screen Tubes:
 - a. Use with hollow base materials.
 - b. Stainless steel screen.
6. Anchor: All-thread stainless steel.
7. Minimum Embedment: 4 inches unless otherwise indicated.

F. Capsule Anchors: Threaded steel rod, inserts and reinforcing dowels with 45-degree chisel point, complete with nuts, washers, glass or foil capsule anchor system containing polyvinyl or urethane methacrylate-based resin and accelerator, and manufacturer's installation instructions. Type and size as indicated on Drawings.

1. As indicated on the Drawings, provide chisel-pointed stainless-steel anchors. Stainless steel anchors shall be AISI Type 316 stainless steel provided with stainless steel nuts and washers of matching alloy group and minimum proof stress equal to or greater than the specified minimum full-size tensile strength of the externally threaded fastener. All nuts shall conform to ASTM F594 unless otherwise specified. Avoid installing stainless steel anchors in contact with galvanically dissimilar metals.
2. Reinforcing dowels shall be A615 Grade 60, with 45-degree chisel-points at embedded end.

2.5 EPOXY BONDING AGENT

- A. Provide epoxy bonding agent between concrete pours.
- B. Products: Provide one or more of the following products:
 1. SikaDur 32, Hi-Mod
 - a. Manufacturer: Sika, 1-800-933-7452, usa.sika.com or equal.

PART 3 - EXECUTION

3.1 INSTALLATION

- A. Cast-In-Place Bolts: Use templates to locate bolts accurately and securely in formwork.
- B. Drilled-In Anchors:
 1. Drill holes with rotary impact hammer drills using carbide-tipped bits, hollow drill bit system, or core drills using diamond core bits. Drill bits shall be of diameters as specified by the anchor manufacturer. Unless otherwise shown on the Drawings, all holes shall be drilled perpendicular to the concrete surface.
 - a. Cored Holes: Where anchors are permitted to be installed in cored holes, use core bits with matched tolerances as specified by the manufacturer. Properly clean cored hole per manufacturer's instructions.
 - b. Embedded Items: Identify position of reinforcing steel and other embedded items prior to drilling holes for anchors. Exercise care in coring or drilling to avoid damaging existing reinforcing or embedded items. Notify the Engineer if reinforcing steel or other embedded items are encountered during drilling. Take precautions as necessary to avoid damaging prestressing tendons, electrical and telecommunications conduit, and gas lines.

- c. Base Material Strength: Unless otherwise specified, do not drill holes in concrete or masonry until concrete, mortar, or grout has achieved full design strength.
2. Perform anchor installation in accordance with manufacturer instructions.
3. Wedge Anchors, Heavy-Duty Sleeve Anchors, and Undercut Anchors: Protect threads from damage during anchor installation. Heavy-duty sleeve anchors shall be installed with sleeve fully engaged in part to be fastened. Set anchors to manufacturer's recommended torque, using a torque wrench. Following attainment of 10% of the specified torque, 100% of the specified torque shall be reached within 7 or fewer complete turns of the nut. If the specified torque is not achieved within the required number of turns, the anchor shall be removed and replaced unless otherwise directed by the Engineer.
4. Cartridge Injection Adhesive Anchors: Clean all holes per manufacturer instructions to remove loose material and drilling dust prior to installation of adhesive. Inject adhesive into holes proceeding from the bottom of the hole and progressing toward the surface in such a manner as to avoid introduction of air pockets in the adhesive. Follow manufacturer recommendations to ensure proper mixing of adhesive components. Sufficient adhesive shall be injected in the hole to ensure that the annular gap is filled to the surface. Remove excess adhesive from the surface. Shim anchors with suitable device to center the anchor in the hole. Do not disturb or load anchors before manufacturer specified cure time has elapsed.
5. Capsule Anchors: Perform drilling and setting operations in accordance with manufacturer instructions. Clean all holes to remove loose material and drilling dust prior to installation of adhesive. Remove water from drilled holes in such a manner as to achieve a surface dry condition. Capsule anchors shall be installed with equipment conforming to manufacturer recommendations. Do not disturb or load anchors before manufacturer specified cure time has elapsed.
6. Observe manufacturer recommendations with respect to installation temperatures for cartridge injection adhesive anchors and capsule anchors.

C. Apply epoxy bonding agent per manufacturer's recommendations. Prepare surfaces as required. Apply fresh concrete to hardened concrete within the allotted pot life of the product.

3.2 REPAIR OF DEFECTIVE WORK

A. Remove and replace misplaced or malfunctioning anchors. Fill empty anchor holes and patch failed anchor locations with high-strength non-shrink, nonmetallic grout. Anchors that fail to meet proof load or installation torque requirements shall be regarded as malfunctioning.

3.3 FIELD QUALITY CONTROL

- A. Testing: 10% of each type and size of drilled-in anchor shall be proof loaded by the independent testing laboratory. Adhesive anchors and capsule anchors shall not be torque tested unless otherwise directed by the Engineer. If more than 10% of the tested anchors fail to achieve the specified torque or proof load within the limits as defined in the Contract Documents or equipment manufacturers' recommendations, all anchors of the same diameter and type as the failed anchor shall be tested, unless otherwise instructed by the Engineer.
1. Tension testing should be performed in accordance with ASTM E488.
 2. Torque shall be applied with a calibrated torque wrench.
 3. Proof loads shall be applied with a calibrated hydraulic ram. Displacement of adhesive and capsule anchors at proof load shall not exceed $D/10$, where D is the nominal anchor diameter.
- B. Minimum anchor embedments, proof loads and torques shall be as shown on the Drawings or as required by equipment manufacturer's recommendations.

END OF SECTION 03 15 00

SECTION 03 30 00 - CAST-IN-PLACE CONCRETE

PART 1 - GENERAL

1.1 SUMMARY

- A. Section includes cast-in-place concrete, including formwork, reinforcement, concrete materials, mixture design, placement procedures, and finishes.

1.2 ACTION SUBMITTALS

- A. Product Data: For each type of product.
- B. Design Mixtures: For each concrete mixture.
- C. Qualifications of independent testing agency.
- D. Steel Reinforcement Shop Drawings: Placing Drawings that detail fabrication, bending, and placement. Including all rebar coupling/splicing products/locations.
- E. Placement schedule for all pours.

1.3 INFORMATIONAL SUBMITTALS

- A. Material certificates.
- B. Material test reports.
- C. Formwork Shop Drawings: Prepared by or under the supervision of a qualified professional Engineer, detailing fabrication, assembly, and support of formwork.
- D. Rebar coupling/splicing products.

1.4 QUALITY ASSURANCE

- A. Manufacturer Qualifications: A firm experienced in manufacturing ready-mixed concrete products and that complies with ASTM C 94/C 94M requirements for production facilities and equipment.
 - 1. Manufacturer certified according to NRMCA's "Certification of Ready Mixed Concrete Production Facilities."
- B. Testing Agency Qualifications: An independent agency, approved by Engineer and Owner, qualified according to ASTM C 1077 and ASTM E 329 for testing indicated, as documented according to ASTM E 548.
 - 1. Personnel conducting field tests shall be qualified as ACI Concrete Field-Testing Technician, Grade 1, according to ACI CP-01 or an equivalent certification program.
 - 2. Personnel performing laboratory tests shall be ACI-certified Concrete Strength Testing Technician and Concrete Laboratory Testing Technician - Grade I. Testing Agency laboratory supervisor shall be an ACI-certified Concrete Laboratory Testing Technician - Grade II.
- C. Concrete Testing Service: Contractor shall engage a qualified independent testing agency to perform material evaluation tests, to design concrete mixtures, and to perform field tests.

1.5 PRECONSTRUCTION AND CONSTRUCTION TESTING

- A. Preconstruction Testing Service: Engage An independent qualified testing agency to perform preconstruction testing on concrete mixtures.
- B. construction Testing Service: Engage an independent qualified testing agency to perform field testing of concrete mixtures during each placement.

1.6 FIELD CONDITIONS

- A. Cold-Weather Placement: Comply with ACI 306.1.
 - 1. Do not use calcium chloride, salt, or other materials containing antifreeze agents or chemical accelerators unless otherwise specified and approved in mixture designs.
- B. Hot-Weather Placement: Comply with ACI 301.

PART 2 - PRODUCTS

2.1 CONCRETE, GENERAL

- A. ACI Publications: Comply with the following unless modified by requirements in the Contract Documents:
 - 1. ACI 301
 - 2. ACI 350
 - 3. ACI 117

2.2 FORM-FACING MATERIALS

- A. Smooth-Formed Finished Concrete: Form-facing panels that provide continuous, true, and smooth concrete surfaces. Furnish in largest practicable sizes to minimize number of joints.
- B. Rough-Formed Finished Concrete: Plywood, lumber, metal, or another approved material. Provide lumber dressed on at least two edges and one side for tight fit.

2.3 STEEL REINFORCEMENT

- A. Reinforcing Bars: ASTM A 615/A 615M, Grade 60, deformed.
- B. Low-Alloy-Steel Reinforcing Bars: ASTM A 706/A 706M, deformed.
- C. Epoxy-Coated Reinforcing Bars: ASTM A 615/A 615M, Grade 60, deformed bars, ASTM A 775/A 775M, epoxy coated, with less than 1 percent damaged coating in each 12-inch bar length.
- D. Plain-Steel Welded-Wire Reinforcement: ASTM A 1064/A 1064M, plain, fabricated from as-drawn steel wire into flat sheets.
- E. Deformed-Steel Welded-Wire Reinforcement: ASTM A 1064/A 1064M, flat sheet.
- F. Galvanized-Steel Welded-Wire Reinforcement: ASTM A 1064/A 1064M, plain, fabricated from galvanized-steel wire into flat sheets.
- G. Epoxy-Coated Welded-Wire Reinforcement: ASTM A 884/A 884M, Class A coated, Type 1, plain steel.

H. Bar Supports: Bolsters, chairs, spacers, and other devices for spacing, supporting, and fastening reinforcing bars and welded-wire reinforcement in place. Manufacture bar supports from steel wire, plastic, or precast concrete according to CRSI's "Manual of Standard Practice."

2.4 CONCRETE MATERIALS

A. Cementitious Materials:

1. Portland Cement: ASTM C 150/C 150M, Type II, Type I/II, Type III, gray.
2. Fly Ash: ASTM C 618, Class F or C.
3. Slag Cement: ASTM C 989/C 989M, Grade 100 or 120.
4. Blended Hydraulic Cement: ASTM C 595/C 595M, Type IS, portland blast-furnace slag cement.

B. Normal-Weight Aggregates: ASTM C 33/C 33M, graded.

1. Maximum Coarse-Aggregate Size: 1-1/2 inches nominal for pours greater than 10" thick, 3/4-inch nominal for pours between 6 inches thick and 3 inches thick, 1/2 inch nominal for pours less than 3 inches thick.
2. Fine Aggregate: Free of materials with deleterious reactivity to alkali in cement.

C. Air-Entraining Admixture: ASTM C 260/C 260M.

D. Water: ASTM C 94/C 94M and potable.

2.5 RELATED MATERIALS

A. Expansion- and Isolation-Joint-Filler Strips: ASTM D 1751, asphalt-saturated cellulosic fiber.

2.6 CONCRETE MIXTURES, GENERAL

A. Prepare design mixtures for each type and strength of concrete, proportioned on the basis of laboratory trial mixture or field test data, or both, according to ACI 301.

B. Cementitious Materials: Use fly ash, pozzolan, slag cement, and silica fume as needed to reduce the total amount of portland cement, which would otherwise be used, by not less than 40 percent.

2.7 CONCRETE MIXTURES

A. Normal-Weight Concrete (includes filter underdrains, equipment bases and structural components):

1. Minimum Compressive Strength: 4000 psi at 28 days.
2. Concrete formulation to be used is a six-sack mix (564 pounds cement per cubic yard).
3. Aggregate shall be 1/2-inch or smaller. Aggregates larger than 1/2-inch shall not be permitted.
4. Slump Limit: 3 inches.
5. Concrete should be poured as dry as possible to avoid excessive fines from washing between the forms.
6. Concrete mixture shall meet filter equipment manufacturer's requirements.

B. Concrete infill (for use as infill in channels and other areas, non-structural)

1. Minimum Compressive Strength: 3500 psi at 28 days.
2. Maximum W/C Ratio: 0.45.
3. Slump Limit: 6-inches, plus or minus 1 inch.
4. Air Content: 5.5 percent, plus or minus 1.5 percent at point of delivery for 1-1/2-inch nominal maximum aggregate size.

5. Air Content: 6 percent, plus or minus 1.5 percent at point of delivery for 3/4-inch nominal maximum aggregate size.
6. Air Content: Do not allow air content of trowel-finished floors to exceed 3 percent.

2.8 FABRICATING REINFORCEMENT

- A. Fabricate steel reinforcement according to CRSI's "Manual of Standard Practice."

2.9 CONCRETE MIXING

- A. Ready-Mixed Concrete: Measure, batch, mix, and deliver concrete according to ASTM C 94/C 94M and ASTM C 1116/C 1116M, and furnish batch ticket information.
 1. When air temperature is between 85 and 90 deg F, reduce mixing and delivery time from 1-1/2 hours to 75 minutes; when air temperature is above 90 deg F, reduce mixing and delivery time to 60 minutes.

PART 3 - EXECUTION

3.1 FORMWORK INSTALLATION

- A. Design, erect, shore, brace, and maintain formwork, according to ACI 301, to support vertical, lateral, static, and dynamic loads, and construction loads that might be applied, until structure can support such loads.
- B. Construct formwork so concrete members and structures are of size, shape, alignment, elevation, and position indicated, within tolerance limits of ACI 117.
- C. Chamfer exterior corners and edges of permanently exposed concrete.

3.2 EMBEDDED ITEM INSTALLATION

- A. Place and secure anchorage devices and other embedded items required for adjoining work that is attached to or supported by cast-in-place concrete. Use setting drawings, templates, diagrams, instructions, and directions furnished with items to be embedded.
- B. Sheet Vapor Retarders: Place, protect, and repair sheet vapor retarder according to ASTM E 1643 and manufacturer's written instructions.
 1. Lap joints 6 inches and seal with manufacturer's recommended tape.

3.3 STEEL REINFORCEMENT INSTALLATION

- A. General: Comply with CRSI's "Manual of Standard Practice" for fabricating, placing, and supporting reinforcement.
 1. Do not cut or puncture vapor retarder. Repair damage and reseal vapor retarder before placing concrete.

3.4 JOINTS

- A. General: Construct joints true to line with faces perpendicular to surface plane of concrete.
- B. Construction Joints: Install so strength and appearance of concrete are not impaired, at locations indicated or as approved by Engineer. If not shown, place joints at intervals not exceeding 50'. For joints in water-containing structures or tanks or occupied spaces below maximum known groundwater elevations, use watertight joints.

3.5 CONCRETE PLACEMENT

- A. Before placing concrete, verify that installation of formwork, reinforcement, and embedded items is complete and that required inspections are completed.
- B. Deposit concrete continuously in one layer or in horizontal layers of such thickness that no new concrete is placed on concrete that has hardened enough to cause seams or planes of weakness. If a section cannot be placed continuously, provide construction joints as indicated. Deposit concrete to avoid segregation.
 - 1. Consolidate placed concrete with mechanical vibrating equipment according to ACI 301.

3.6 FINISHING FORMED SURFACES

- A. Rough-Formed Finish: As-cast concrete texture imparted by form-facing material with tie holes and defects repaired and patched. Remove fins and other projections that exceed specified limits on formed-surface irregularities.
 - 1. Apply to concrete surfaces not exposed to public view.
- B. Smooth-Formed Finish: As-cast concrete texture imparted by form-facing material, arranged in an orderly and symmetrical manner with a minimum of seams. Repair and patch tie holes and defects. Remove fins and other projections that exceed specified limits on formed-surface irregularities.
 - 1. Apply to concrete surfaces exposed to public view.
- C. Related Unformed Surfaces: At tops of walls, horizontal offsets, and similar unformed surfaces adjacent to formed surfaces, strike off smooth and finish with a texture matching adjacent formed surfaces. Continue final surface treatment of formed surfaces uniformly across adjacent unformed surfaces unless otherwise indicated.

3.7 CONCRETE PROTECTING AND CURING

- A. General: Protect freshly placed concrete from premature drying and excessive cold or hot temperatures. Comply with ACI 306.1 for cold-weather protection and ACI 301 for hot-weather protection during curing.
- B. Formed Surfaces: Cure formed concrete surfaces, including underside of beams, supported slabs, and other similar surfaces. If forms remain during curing period, moist cure after loosening forms. If removing forms before end of curing period, continue curing for remainder of curing period.
- C. Cure concrete according to ACI 308.1, by one or a combination of the following methods:
 - 1. Moisture Curing: Keep surfaces continuously moist for not less than seven days.
 - 2. Moisture-Retaining-Cover Curing: Cover concrete surfaces with moisture-retaining cover for curing concrete, placed in widest practicable width, with sides and ends lapped at least 12 inches, and sealed by waterproof tape or adhesive. Cure for not less than seven days. Immediately repair any holes or tears during curing period, using cover material and waterproof tape.
 - 3. Curing Compound: Apply uniformly in continuous operation by power spray or roller according to manufacturer's written instructions. Recoat areas subjected to heavy rainfall within three hours after initial application. Maintain continuity of coating and repair damage during curing period.
 - 4. Curing and Sealing Compound: Apply uniformly to floors and slabs indicated in a continuous operation by power spray or roller according to manufacturer's written instructions. Recoat areas subjected to heavy rainfall within three hours after initial

application. Repeat process 24 hours later and apply a second coat. Maintain continuity of coating and repair damage during curing period.

- D. Mass Concrete: Use insulation and/or blankets as required to reduce the thermal differential between core and surface concrete temperatures.

3.8 CONCRETE SURFACE REPAIRS

- A. Defective Concrete: Repair and patch defective areas when approved by Engineer. Remove and replace concrete that cannot be repaired and patched to Engineer's approval.

3.9 FIELD QUALITY CONTROL

- A. Testing and Inspecting: Contractor to engage an independent qualified testing and inspecting agency to perform tests and inspections and to submit reports.

B. Inspections:

1. Steel reinforcement placement.
2. Steel reinforcement welding.
3. Headed bolts and studs.
4. Verification of use of required design mixture.
5. Concrete placement, including conveying and depositing.
6. Curing procedures and maintenance of curing temperature.
7. Verification of concrete strength before removal of shores and forms from beams and slabs.

- C. Concrete Tests: Testing of composite samples of fresh concrete obtained according to ASTM C 172 shall be performed according to the following requirements:

1. Testing Frequency: Obtain at least one composite sample for each 100 cu. yd. or fraction thereof of each concrete mixture placed each day.
 - a. When frequency of testing will provide fewer than five compressive-strength tests for each concrete mixture, testing shall be conducted from at least five randomly selected batches or from each batch if fewer than five are used.
2. Slump: ASTM C 143/C 143M; one test at point of placement for each composite sample, but not less than one test for each day's pour of each concrete mixture. Perform additional tests when concrete consistency appears to change.
3. Air Content: ASTM C 231, pressure method, for normal-weight concrete; ASTM C 173/C 173M, volumetric method, for structural lightweight concrete; one test for each composite sample, but not less than one test for each day's pour of each concrete mixture.
4. Concrete Temperature: ASTM C 1064/C 1064M; one test hourly when air temperature is 40 degree F and below and when 80 degree F and above, and one test for each composite sample.
5. Unit Weight: ASTM C 567, fresh unit weight of structural lightweight concrete; one test for each composite sample, but not less than one test for each day's pour of each concrete mixture.
6. Compression Test Specimens: ASTM C 31/C 31M.
 - a. Cast and laboratory cure two sets of two standard cylinder specimens for each composite sample.
 - b. Cast and field cure two sets of two standard cylinder specimens for each composite sample.
7. Compressive-Strength Tests: ASTM C 39/C 39M; test one set of two laboratory-cured specimens at 7 days and one set of two specimens at 28 days.
 - a. Test one set of two field-cured specimens at 7 days and one set of two specimens at 28 days.
 - b. A compressive-strength test shall be the average compressive strength from a set of two specimens obtained from same composite sample and tested at age indicated.

8. When strength of field-cured cylinders is less than 85 percent of companion laboratory-cured cylinders, Contractor shall evaluate operations and provide corrective procedures for protecting and curing in-place concrete.
 9. Strength of each concrete mixture will be satisfactory if every average of any three-consecutive compressive-strength tests equals or exceeds specified compressive strength and no compressive-strength test value falls below specified compressive strength by more than 500 psi.
 10. Test results shall be reported in writing to Engineer, concrete manufacturer, and Contractor within 48 hours of testing. Reports of compressive-strength tests shall contain Project identification name and number, date of concrete placement, name of concrete testing and inspecting agency, location of concrete batch in Work, design compressive strength at 28 days, concrete mixture proportions and materials, compressive breaking strength, and type of break for both 7- and 28-day tests.
 11. Nondestructive Testing: Impact hammer, sonoscope, or other nondestructive device may be permitted by Engineer but will not be used as sole basis for approval or rejection of concrete.
 12. Additional Tests: Testing and inspecting agency shall make additional tests of concrete when test results indicate that slump, air entrainment, compressive strengths, or other requirements have not been met, as directed by Engineer. Testing and inspecting agency may conduct tests to determine adequacy of concrete by cored cylinders complying with ASTM C 42/C 42M or by other methods as directed by Engineer.
 13. Additional testing and inspecting, at Contractor's expense, will be performed to determine compliance of replaced or additional work with specified requirements.
 14. Correct deficiencies in the Work that test reports and inspections indicate do not comply with the Contract Documents.
 15. Measure floor and slab flatness and levelness according to ASTM E 1155 within 48 hours of finishing.
- D. Waterproofing: Those parts of a structure below the maximum known groundwater level shall be substantially watertight. There shall be no evidence of leaks after concrete has cured and been backfilled and groundwater returned to normal levels.
1. Repair all cracks and defects which impair water-tightness and eliminate any leakage into the structure as directed by the Engineer.
 2. Tank penetrations, pipe, channel, and conduit outlets shall be checked prior to final acceptance to determine the water-tightness of these appurtenances. Leakage at these outlets shall be repaired prior to final payment.

END OF SECTION 03 30 00

SECTION 05 50 00 - METAL FABRICATIONS

PART 1 - GENERAL

1.1 SUMMARY

A. Section Includes:

1. Stainless steel framing and plates for weir wall extensions.
2. Galvanized steel framing and serrated grating for shaft accesses.
3. Steel framing and supports for applications where framing and supports are not specified in other Sections.

B. Related Requirements:

1. Section 01 40 00 "Quality Requirements" for quality control procedures.
2. Section 01 73 00 "Execution" for cutting and patching procedures
3. Section 03 15 00 "Concrete Accessories" for information on anchor bolts and independent testing.

1.2 ACTION SUBMITTALS

- ##### A. Shop Drawings: Show fabrication and installation details. Include plans, elevations, sections, and details of metal fabrications and their connections. Show anchorage and accessory items. Provide Shop Drawings for the following:
1. Weir wall plate and frames.

1.3 INFORMATIONAL SUBMITTALS

- ##### A. Welding certificates.

1.4 QUALITY ASSURANCE

- ##### A. Welding Qualifications: Qualify procedures and personnel in accordance with the following:
1. AWS D1.1/D1.1M, "Structural Welding Code - Steel."

1.5 FIELD CONDITIONS

- ##### A. Field Measurements: Verify actual locations of walls, floor slabs, decks, and other construction contiguous with metal fabrications by field measurements before fabrication.

PART 2 - PRODUCTS

2.1 METALS

- ##### A. Metal Surfaces, General: Provide materials with smooth, flat surfaces unless otherwise indicated. For metal fabrications exposed to view in the completed Work, provide materials without seam marks, roller marks, rolled trade names, or blemishes.
- ##### B. Stainless Steel Plates, Shapes, and Bars: ASTM A240, Type 316.
- ##### C. Stainless Steel Angles and Channels: ASTM A276, Type 316.
- ##### D. Steel Plates and Bars: ASTM A36.

E. Steel Angle and Channels: ASTM A36.

2.2 FASTENERS

- A. High-Strength Bolts, Nuts, and Washers: ASTM A 325, Type 1, heavy-hex steel structural bolts; ASTM A 563, Grade C, heavy-hex carbon-steel nuts; and ASTM F 436, Type 1, hardened carbon-steel washers; galvanized.
- B. Steel Bolts and Nuts: Regular hexagon-head bolts, ASTM A307, Grade A; with hex nuts, ASTM A563; and, where indicated, flat washers, galvanized.
- C. Anchors, General: Capable of sustaining, without failure, a load equal to six times the load imposed when installed in unit masonry and four times the load imposed when installed in concrete, as determined by testing in accordance with ASTM E488/E488M, conducted by a qualified independent testing agency.
- D. Post-Installed Anchors:
 - 1. Wedge Anchors - Stainless Steel (ASTM F593) with stainless steel nuts and washers for all applications, Hilti KB3.
 - 2. Adhesive Anchors - Hilti HIT-HY200 with stainless steel threaded inserts.

2.3 MISCELLANEOUS MATERIALS

- A. Steel shop primer shall be a modified alkyd rust-inhibitive primer, Tnemec Series V10, or approved equal, gray in color Min DFT=2.0 mils. Steel finish paint shall be acrylic emulsion, Tnemec 1026 Endurotone, or approved equal gray in color. Min. DFT=3.0 mils.
- B. Shrinkage-Resistant Grout: Factory-packaged, nonmetallic, nonstaining, noncorrosive, nongaseous grout complying with ASTM C1107/C1107M. Provide grout specifically recommended by manufacturer for interior and exterior applications.

2.4 FABRICATION, GENERAL

- A. Shop Assembly: Preassemble items in the shop to greatest extent possible. Disassemble units only as necessary for shipping and handling limitations. Use connections that maintain structural value of joined pieces. Clearly mark units for reassembly and coordinated installation.
- B. Cut, drill, and punch metals cleanly and accurately. Remove burrs and ease edges to a radius of approximately 1/32 inch unless otherwise indicated. Remove sharp or rough areas on exposed surfaces.
- C. Form bent-metal corners to smallest radius possible without causing grain separation or otherwise impairing work.
- D. Form exposed work with accurate angles and surfaces and straight edges.
- E. Weld corners and seams continuously to comply with the following:
 - 1. Use materials and methods that minimize distortion and develop strength and corrosion resistance of base metals.
 - 2. Obtain fusion without undercut or overlap.
 - 3. Remove welding flux immediately.
 - 4. At exposed connections, finish exposed welds and surfaces smooth and blended so no roughness shows after finishing.

- F. Form exposed connections with hairline joints, flush and smooth, using concealed fasteners or welds where possible. Where exposed fasteners are required, use Phillips flat-head (countersunk) fasteners unless otherwise indicated. Locate joints where least conspicuous.
- G. Fabricate seams and other connections that are exposed to weather in a manner to exclude water. Provide weep holes where water may accumulate.
- H. Cut, reinforce, drill, and tap metal fabrications as indicated to receive finish hardware, screws, and similar items.
- I. Provide for anchorage of type indicated; coordinate with supporting structure. Space anchoring devices to secure metal fabrications rigidly in place and to support indicated loads.
- J. Where units are indicated to be cast into concrete or built into masonry, equip with integrally welded steel strap anchors, 1/8 by 1-1/2 inches, with a minimum 6-inch embedment and 2-inch hook, not less than 8 inches from ends and corners of units and 24 inches o.c., unless otherwise indicated.
- K. Where units are indicated to be welded shear connectors, equip with integrally welded steel strap anchors, 1/2 inch diameter by 6 inches, not less than 8 inches from ends and corners of units and 24 inches o.c., unless otherwise indicated.

2.5 MISCELLANEOUS FRAMING AND SUPPORTS

- A. General: Provide steel framing and supports not specified in other Sections as needed to complete the Work.
- B. Fabricate units from steel shapes, plates, and bars of welded construction unless otherwise indicated. Fabricate to sizes, shapes, and profiles indicated and as necessary to receive adjacent construction.
 - 1. Fabricate units from slotted channel framing where indicated.
 - 2. Furnish inserts for units installed after concrete is placed.
 - 3. Clean all steel surfaces to SSPC-SP6 and apply primer (min. DFT=2.0 mils) and top coat (min. DFT=3.0 mils).

2.6 STEEL WELD PLATES AND ANGLES

- A. Provide steel weld plates and angles not specified in other Sections, for items supported from concrete construction as needed to complete the Work. Provide each unit with no fewer than two integrally welded steel strap anchors for embedding in concrete.

2.7 STEEL AND IRON FINISHES

- A. All steel components (except stainless steel as indicated) shall be hot-dip galvanized.

PART 3 - EXECUTION

3.1 INSTALLATION, GENERAL

- A. Cutting, Fitting, and Placement: Perform cutting, drilling, and fitting required for installing metal fabrications. Set metal fabrications accurately in location, alignment, and elevation; with edges and surfaces level, plumb, true, and free of rack; and measured from established lines and levels.

- B. Fit exposed connections accurately together to form hairline joints. Weld connections that are not to be left as exposed joints but cannot be shop welded because of shipping size limitations. Do not weld, cut, or abrade surfaces of exterior units that have been hot-dip galvanized after fabrication and are for bolted or screwed field connections.
- C. Field Welding: Comply with the following requirements:
 - 1. Use materials and methods that minimize distortion and develop strength and corrosion resistance of base metals.
 - 2. Obtain fusion without undercut or overlap.
 - 3. Remove welding flux immediately.
 - 4. At exposed connections, finish exposed welds and surfaces smooth and blended so no roughness shows after finishing and contour of welded surface matches that of adjacent surface.
- D. Fastening to In-Place Construction: Provide anchorage devices and fasteners where metal fabrications are required to be fastened to in-place construction. Provide threaded fasteners for use with concrete and masonry inserts, toggle bolts, through bolts, lag screws, wood screws, and other connectors.
- E. Provide temporary bracing or anchors in formwork for items that are to be built into concrete, masonry, or similar construction.
 - 1. Cast Aluminum: Heavy coat of bituminous paint.
 - 2. Extruded Aluminum: Two coats of clear lacquer.

3.2 INSTALLATION OF MISCELLANEOUS FRAMING AND SUPPORTS

- A. General: Install framing and supports to comply with requirements of items being supported, including manufacturers' written instructions and requirements indicated on Shop Drawings.

3.3 INSTALLATION OF BEARING AND LEVELING PLATES

- A. Clean concrete and masonry bearing surfaces of bond-reducing materials, and roughen to improve bond to surfaces. Clean bottom surface of plates.
- B. Set bearing and leveling plates on wedges, shims, or leveling nuts. After bearing members have been positioned and plumbed, tighten anchor bolts. Do not remove wedges or shims but, if protruding, cut off flush with edge of bearing plate before packing with shrinkage-resistant grout. Pack grout solidly between bearing surfaces and plates to ensure that no voids remain.

3.4 REPAIRS

- A. Galvanizing and Repair Painting of field welds, bolted connections, and abraded galvanized areas: Cold Galvanizing High Zinc Content: 95% zinc by weight dry film. Clean surfaces to receive cold galvanizing coating per manufacturer's recommendations.

END OF SECTION 05 50 00

SECTION 09 92 00 – FACILITY PAINTING

PART 1 - GENERAL

1.1 RELATED DOCUMENTS

- A. Drawings and general provisions of the Contract, including General Conditions, Supplementary Conditions (if included), and Division 1 Specifications Sections, apply to this Section.

1.2 SECTION INCLUDES

- A. This Section includes all surface preparation, field painting and finishing of exposed interior and exterior items and surfaces on the Project.
- B. Surface preparation, priming, and finish coats specified in this Section are in addition to shop priming and surface treatment specified under other Sections.
- C. Paint exposed surfaces whether or not substrate is designated in schedules but would normally be painted, except where a surface or material is specifically indicated not to be painted or is to remain natural. Where an item or surface is not specifically mentioned, paint the same as similar adjacent materials or surfaces. If color or finish is not designated, Owner will select from standard colors or finishes available.
- D. Painting includes field painting exposed bare and covered pipes and ducts (including color coding), hangers, exposed steel and iron work, and primed metal surfaces of mechanical and electrical equipment.
- E. See Article 4.2, Paint Systems Schedule, for materials to be used.
- F. See Article 4.1, Painting Schedule, for surfaces to be painted.

1.3 SUBMITTALS

- A. Manufacturer's paint systems Data Sheets for each coat, by substrate, indicating product name, product number, surface preparation, and DFT coverage.
- B. Samples illustrating range of colors available for each surface finishing material scheduled for color selection by Owner.
- C. Certification that products meet or exceed Specifications.

1.4 REGULATORY REQUIREMENTS

- A. Conform to applicable code for flame and smoke rating requirements for finishes.
- B. Paints, coatings, sealers or liners which contact raw, partially treated, or potable water and are used in pipes, tanks, or equipment which can convey or store these waters, shall be approved by the Michigan Department of Environment, Great Lakes and Energy before application.

1.5 DELIVERY, STORAGE, AND HANDLING

- A. Deliver products to Site in sealed and labeled containers; inspect to verify acceptability.

- B. Container label to include manufacturer's name, type of paint, brand name, lot number, brand code, coverage, surface preparation, drying time, cleanup requirements, color designation, and instructions for mixing and reducing.
- C. Store paint materials at minimum ambient temperature of 45 degrees F and a maximum of 90 degrees F in a ventilated area, and as required by manufacturer's instructions.

1.6 ENVIRONMENTAL REQUIREMENTS

- A. Do not apply materials when surface and ambient temperatures are outside the temperature ranges required by the paint product manufacturer.
- B. Do not apply exterior coatings during rain or snow, or when relative humidity is outside the humidity ranges required by the paint product manufacturer.
- C. Minimum Application Temperatures for Latex Paints: 50 degrees F for interior or exterior, unless required otherwise by manufacturer's instructions. Surface temperature must be at least 5 degrees F greater than the dew point.
- D. Minimum Application Temperature for Varnish and Similar Finishes: 50 degrees F for interior or exterior, unless required otherwise by manufacturer's instructions. Surface temperature must be at least 5 degrees F greater than the dew point.
- E. Provide lighting level of 80-foot candles measured mid-height at substrate surface. Refer to SSPC-Guide 12, Guide for Illumination of Industrial Painting Projects for additional guidelines.

PART 2 - PRODUCTS

2.1 MANUFACTURERS

- A. Carboline Company.
- B. Devoe High Performance Coatings.
- C. PPG (Pittsburg Paints) High Performance Coatings.
- D. The Sherwin-Williams (SW) Company.
- E. Tnemec Company, Inc.
- F. Or Engineer approved equal.

2.2 MATERIALS

- A. Coatings: Ready-mixed, except field-catalyzed coatings. Process pigments to a soft paste consistency, capable of being readily and uniformly dispersed to a homogeneous coating; good flow and brushing properties; capable of drying or curing free of streaks or sags.
- B. Accessory Materials: Linseed oil, shellac, turpentine, paint thinners and other materials not specifically indicated but required to achieve the finishes specified of commercial quality. Use products compatible with painting materials and approved by paint manufacturer.
- C. Paint materials and equipment shall be compatible in use.

- D. Primer, Intermediate, and Finish coats shall all be from the same coatings manufacturer. Prime coats shall be compatible with and appropriate for use on surface to be coated.

2.3 COLORS

- A. Colors, if not indicated in Painting Schedule in Part 3, will be selected by OWNER from manufacturer's standard colors.

PART 3 - EXECUTION

3.1 EXAMINATION

- A. Verify that surfaces are ready for application of materials in accordance with the product manufacturer's instructions.
- B. Examine surfaces scheduled to be finished prior to commencement of Work. Report any condition that may potentially affect proper application.
- C. Measure moisture content of surfaces using appropriate method as instructed by the coating manufacturer. Do not apply finishes unless moisture content of surfaces is below the coating manufacturer's acceptable maximums.

3.2 TESTING OF PAINT ON EXISTING SURFACE FINISH

- A. Where paint is to be applied over existing finished surface, apply a test application.
- B. Allow test application to dry overnight. If wrinkling or lifting occurs after overnight drying, application of new paint over existing finished surface will not be allowed. With approval of Engineer, use one of the following alternatives:
- C. Remove existing coating and apply complete system as described in Paint Schedule Article 4.2.
- D. Apply intermediate barrier coat material that is compatible with both the existing finish and the new topcoat and will ensure bonding of new paint to existing surface finish.
- E. Substitute a different coating material that is compatible with and will adhere to existing surface finish.
- F. Cost of test application shall be borne by Contractor.

3.3 PREPARATION

- A. Remove or mask electrical plates, hardware, light fixture trim, escutcheons, and fittings prior to preparing surfaces or finishing. Mask nameplates, descriptive data on pumps, motors and other equipment. Removed item shall be reinstalled by workmen skilled in the trades involved.
- B. Correct defects and clean surfaces which affect Work of this Section.
- C. Remove existing coatings that exhibit poor adhesion or unacceptable surface defects. Existing submerged or vapor zone piping and miscellaneous metals shall be abrasive blast cleaned to remove existing coatings.
- D. Seal marks which may bleed through surface finishes with sealer as instructed by paint manufacturer.

- E. If mildew is encountered, remove by scrubbing with solution of tri-sodium phosphate and bleach. Rinse with clean water and allow surface to dry.
- F. Insulated Coverings: Remove dirt, grease, and oil from canvas and cotton.
- G. Concrete: Concrete surfaces shall be fully aged. Loose, powdery, crumbly concrete shall be dressed down to a firm, sound, hard substrate.
- H. For heavy duty service such as continuous and intermittent immersion, mechanical loading, or for protective coating systems, achieve surface profile CSP 1-9 by acid etching per ASTM D4260, or by mechanical abrasion per ASTM D4259. Refer to ICRI 310.2 for sample chips of CSP 1-9 profile.
- I. Where surfaces are coated with bituminous coating that is not compatible with paint material, remove bituminous coating with abrasive blasting. Bituminous coatings that are destructive to the environment have been banned by the City of Ann Arbor and will not be allowed on this project.
- J. Galvanized Steel Surfaces: Remove surface contamination and oils and wash with solvent. Do not use hydrocarbon solvents if applying waterborne coatings. Apply manufacturer's instructed primer.
- K. Uncoated Steel Surfaces:
 - 1. Welded areas shall be ground smooth per NACE Standard RP 0178.
 - 2. Use abrasives for blast cleaning that are clean, uniformly graded, and free of oil, soluble salts, chlorides, or foreign matter which could contaminate the blasted surface. Size the abrasive to produce an anchor pattern profile height as required by the coating manufacturer.
 - 3. Steel surfaces to be painted and not factory-primed, shall be field abrasive-blasted in accordance with NACE-3 (SSPC-SP6), commercial blast for non-immersion service; and in accordance with NACE-2 (SSPC-SP10), near-white blast for immersion service, unless a higher degree of surface preparation is required by the manufacturer.
- L. Shop-Primed Steel Surfaces:
 - 1. For non-submerged steel surfaces, clean surfaces in accordance with SSPC-SP1 Solvent Cleaning and remove loose primer and rust in accordance with SSPC-SP2 Hand Tool Cleaning or SSPC-SP3 Power Tool Cleaning. Feather edges to make touch-up patches inconspicuous. Prime bare steel surfaces.
 - 2. Retouch damaged areas of shop-primed items with compatible primer.
 - 3. Contractor shall be responsible for compatibility of shop primer with field-finish coats.
 - 4. For metal surfaces in a submerged, vapor, or splash zone, remove shop primer if incompatible with field finish coats, and blast clean to SSPC-SP10 Near-White Blast Clean. Apply primer as specified.
- M. Ductile Iron and Cast Ductile Iron Surfaces:
 - 1. Ductile iron and cast ductile iron surfaces to be painted shall be prepared using the National Association of Pipe Fabricators, Inc. (NAPF) Surface Preparation Standards NAPF 500-03, and not according to SSPC / NACE Standards for preparation of steel surfaces.
 - 2. Remove grease and oil using NAPF Standard 500-03-01 Solvent Cleaning.
 - 3. For interior, non-submerged locations use NAPF 500-03-02 Hand Tool Cleaning and NAPF 500-03-03 Power Tool Cleaning as recommended by paint manufacturer.
 - 4. For submerged, exterior, or vapor or splash zone use NAPF 500-03-04 Abrasive Blast Cleaning for Ductile Iron Pipe and Fittings, and NAPF 500-03-05 Abrasive Blast Cleaning for Cast Ductile Iron Fittings.

- N. Plastic and Fiberglass: Solvent-wipe and scuff sand; apply test sample prior to application to ensure adhesion. CAUTION: Do not use hydrocarbon containing solvents when using waterborne topcoats.

3.4 APPLICATION

- A. Do not apply materials until representative samples of surface preparation are approved by Engineer and an authorized representative of the manufacturer.
- B. Comply with manufacturer's instructions.
- C. Do not thin materials, except to comply with manufacturer's instructions.
- D. Apply coatings to all surfaces with special attention to hard-to-reach areas such as between the legs of back-to-back angles. Apply each coat to achieve the specified dry film thickness.
- E. Do not apply finishes to surfaces that are not dry.
- F. Deficiencies in film or coating thickness shall be corrected by the application of additional coat(s) of material at the expense of Contractor.
- G. Apply each coat to a uniform smooth finish.
- H. Special attention shall be given to ensure that edges, corners, crevices and welds, receive a film or coating thickness equivalent to that of adjacent surfaces. At no time will wet-on-wet applications be permitted. The finished surfaces shall be free from runs, drips, ridges, waves, laps, brush marks and variations in color, texture and finish.
- I. Apply each coat of paint slightly darker than the preceding coat unless otherwise approved.
- J. Sand surfaces lightly between coats as required to achieve required finish.
- K. Vacuum clean surfaces free of loose particles. Use tack cloth just prior to applying next coat.
- L. Where clear finishes are required, tint fillers to match wood. Work fillers into the grain before set. Wipe excess from surface.
- M. Prime concealed surfaces of wood to be scheduled for paint finish with primer paint.
- N. Prime concealed surfaces of interior woodwork scheduled to receive stain or varnish finish with gloss varnish reduced 25 percent with mineral spirits.

3.5 FINISHING MECHANICAL AND ELECTRICAL EQUIPMENT

- A. Paint shop-primed equipment.
- B. Prime and paint insulated and exposed pipes, conduit, boxes, insulated and exposed ducts, hangers, brackets, collars and supports, except where items are pre-finished.
- C. Paint exposed conduit and electrical equipment occurring in finished areas.
- D. Color-code equipment, piping, conduit, and exposed ductwork in accordance with requirements indicated. Color band and identify with flow arrows names and numbering.
- E. Reinstall electrical cover plates, hardware, light fixture trim, escutcheons, and fittings removed prior to finishing.

3.6 FIELD QUALITY CONTROL

- A. Wet Film Thickness: Monitor during application of each successive coat.
- B. Dry Film Thickness: Measure the thickness of each coat applied using non-destructive dry film thickness gages. Calibrate gages and perform thickness measurements in accordance with SSPC-PA2. Disputes regarding coating thickness applied shall be resolved by use of a Tooke Gage (destructive scratch gage) to the extent required. Repair damage created by destructive testing using the complete coating system specified.
- C. Inspection Devices: Contractor shall possess, use, and make available for use by Owner, inspection devices in good working order for dry film thickness measurement. Furnish with the inspection device, U.S. Department of Commerce, National Bureau of Standards certified thickness calibration plates to verify accuracy of the dry film thickness gages.
- D. Curing of Coatings: Cure coatings in accordance with manufacturer's instructions. Test for adequacy of cure by ASTM D5402 Double Rub Method using solvent MEK, or other solvent or test acceptable to coating manufacturer. Use NSF approved test materials when coating will be in contact with potable water.

3.7 CLEANING

- A. Collect waste material which may constitute a fire hazard; place in closed metal containers and remove daily from Site.
- B. Remove masking, over-spray, or drips on adjacent surfaces.

PART 4 - SPECIAL PROVISIONS

- A. The following indicates the surfaces to be painted using the materials specified in Article 4.2 for the type of surface and conditions of service. The painting of piping includes the painting of insulated piping, the painting of all appurtenances in the respective piping lines (valves, operators, metal supports, etc.) and the painting of valves, sluice gates, floor stands, operators, wall castings and other items not installed directly in a pipe line. The painting of electrical conduits includes the painting of all appurtenances in the respective conduit runs (boxes, etc.). Where new piping connects to existing piping, extend the painting to the end of the existing piping at walls, pumps, fixtures, and other terminations.
 - 1. Tertiary Filter Building and Access Structures:
 - a. New piping.
 - b. New electrical conduit.
 - 2. Clear Wells:
 - a. Tertiary Filter Piping within clearwells
 - b. PEW and Washwater Pump suction piping
 - c. Structural galvanized plates
 - d. Cross connection piping and gates
- B. Piping and Electrical Conduit Color Code: Match existing.

4.2 COATING SCHEDULE

- A. Painting System No. 1: Cycloaliphatic Amine Epoxy. For Interior and Exterior Concrete, CMU, Brick and Ferrous Substrates Exposed to Weathering, Intermittent Wetting and/or Mildly Corrosive Environments, For Protection:
 - 1. Surface Preparation: SSPC – SP-13 (NACE 6). Remove surface contaminates per ASTM D4258 (Concrete).

2. Coating Systems:

- a. Tnemec
 - 1) Base Coat: H.S. Epoxy Series 104 at 6 - 8 dry film thickness (DFT).
 - 2) Finish Coat: H.S. Epoxy Series 104 at 6 - 8 dry film thickness (DFT).
 - 3) Total DFT: 12.0 – 16.0 mils
- b. Carboline
 - 1) Base Coat: Carboguard 890 at 6 - 8 dry film thickness (DFT).
 - 2) Finish Coat: Carboguard 890 at 6 - 8 dry film thickness (DFT).
 - 3) Total DFT: 12.0 – 16.0 mils
- c. Sherwin Williams
 - 1) Base Coat: Dura-Plate 235 at 6 - 8 dry film thickness (DFT).
 - 2) Finish Coat: Dura-Plate 235 at 6 - 8 dry film thickness (DFT).
 - 3) Total DFT: 12.0 – 16.0 mils
- d. PPG
 - 1) Base Coat: Amerlock 2 / 400 at 6 - 8 dry film thickness (DFT).
 - 2) Finish Coat: Amerlock 2 / 400 at 6 - 8 dry film thickness (DFT).
 - 3) Total DFT: 12.0 – 16.0 mils

B. Painting System No. 2: Epoxy Urethane. Interior and Exterior Steel or Iron Metals. Non-Coal Tar Epoxy.

- 1. Surface Preparation: SSPC – SP-6 for non-immersion surfaces and SSPC – SP-10 for submerged, intermittent submerged and surfaces within the vapor zone of a submerged area.
- 2. Coating System:
 - a. Tnemec Polyamide Epoxy System consisting of:
 - 1) Shop Primer: Series N69 Hi-Build Epoxoline II at 3.0 mils dry film thickness (DFT).
 - 2) Intermediate Coat: Series N69 Hi-Build Epoxoline II at 4.0 mils DFT.
 - 3) Finish Coat: Series 1075 Endura Shield II at 3.0 mils DFT.
 - 4) Total DFT: 10.0 – 12.0 mils
 - b. Carboline
 - 1) Shop Primer: Series 890 Hydro-Zinc at 3.0 mils dry film thickness (DFT).
 - 2) Intermediate Coat: Series 890 Beige Pota-Pox at 4.0 mils DFT.
 - 3) Finish Coat: Series 134 HG at 3.0 mils DFT.
 - 4) Total DFT: 10.0 – 12.0 mils
 - c. Sherwin Williams
 - 1) Shop Primer: Series Macropoxy 646 at 3.0 mils dry film thickness (DFT).
 - 2) Intermediate Coat: Series Macropoxy 646 at 4.0 mils DFT.
 - 3) Finish Coat: Series Acrolon 218 or Hi-Solids Polyurethane (hot weather alternative) Endura Shield at 3.0 mils DFT.
 - 4) Total DFT: 10.0 – 12.0 mils
 - d. PPG
 - 1) Shop Primer: Series Pittguard 97-145 Series at 4.0 – 7.0 mils dry film thickness (DFT).
 - 2) Intermediate Coat: Pittguard 97-145 Series at 4.0 – 7.0 mils DFT.
 - 3) Finish Coat: Series Durethane DTM at 3.0 – 5.0 mils DFT.
 - 4) Total DFT: 11.0 – 19.0 mils

END OF SECTION 09 92 00

SECTION 32 92 00 - TURF AND GRASSES

PART 1 - GENERAL

1.1 SUMMARY

- A. Work shall include the furnishing of all labor, materials, tools, equipment, and services necessary for the restoration of the surfaces shown on the drawings and/or as herein required.
- B. Disposal of excess or unsuitable materials shall be considered as part of the restoration work. All such work shall be in accordance with the best modern practice, the Owner's standards, and as specified herein. In the event that these specifications conflict with those of the Owner or the controlling agency, the more stringent requirements shall govern. No permanent surface restoration shall be performed until all underground work has been approved.
- C. Section Includes:
 - 1. Fescue Lawn Seed Mix.
 - 2. Dry-Mesic Pollinator Seed Mix.
 - 3. Erosion-Control Material(s).

1.2 DEFINITIONS

- A. Duff Layer: The surface layer of native topsoil that is composed of mostly decayed leaves, twigs, and detritus.
- B. Finish Grade: Elevation of finished surface of planting soil.
- C. Manufactured Topsoil: Soil produced off-site by homogeneously blending mineral soils or sand with stabilized organic soil amendments to produce topsoil or planting soil.
- D. Pesticide: A substance or mixture intended for preventing, destroying, repelling, or mitigating a pest. This includes insecticides, miticides, herbicides, fungicides, rodenticides, and molluscicides. It also includes substances or mixtures intended for use as a plant regulator, defoliant, or desiccant.
- E. Pests: Living organisms that occur where they are not desired or that cause damage to plants, animals, or people. These include insects, mites, grubs, mollusks (snails and slugs), rodents (gophers, moles, and mice), unwanted plants (weeds), fungi, bacteria, and viruses.
- F. Planting Soil and Topsoil: Existing, on-site soil; imported soil; or manufactured soil that has been modified as specified with soil amendments and perhaps fertilizers to produce a soil mixture best for prairie plant and lawn growth.
- G. Subgrade: Surface or elevation of subsoil remaining after excavation is complete or top surface of a fill or backfill before planting soil is placed.
- H. Subsoil: All soil beneath the topsoil layer of the soil profile and typified by the lack of organic matter and soil organisms.
- I. Surface Soil: Soil that is present at the top layer of the existing soil profile at the Project site. In undisturbed areas, the surface soil is typically topsoil, but in disturbed areas such as urban environments, the surface soil can be subsoil.

1.3 PRODUCT, DELIVERY, STORAGE, AND HANDLING

- A. All seeds shall be packaged and kept dry and cool to ensure adequate protection against damage, and maintain dormancy while in transit, storage or during planting operations. Seed shall be less than one year old. Seed shall be stored as recommended by supplier.
- B. All seed shall be delivered to the site in sealed containers and labeled, in compliance with the Federal Seed Act and Michigan Seed Law (P.A. 329, 1965).
- C. When applicable, the native seed supplier shall provide seed that has been treated to overcome dormancy mechanisms during the first growing season. Some of the specified species do not require this treatment.

1.4 SUBMITTALS

- A. Seed Mixes. Prior to construction, submit for approval to the Engineer a written description of the proposed seed mixes indicating the following:
 - 1. Name and Location of seed supplier(s)
 - 2. Geographic origins of seed
 - 3. Percentage of Pure Live Seed (PLS) for each species or commitment by supplier to provide germination results
 - 4. Proposed substitutions of species due to lack of availability, including species and amount substituted. All substitutions must be approved by Project Engineer at least 2 weeks prior to seeding
 - 5. Submit copies of all seed labels to Engineer
- B. Schedule. At the pre-construction meeting, submit a project work schedule to the Engineer indicating the dates of each of the following events:
 - 1. Seed bed preparation
 - 2. Seed installation
 - 3. Substantial completion of work
- C. Topsoil Test Reports.
 - 1. PH test report.
 - 2. Sieve analysis meeting the requirements of Section 2.05.
 - 3. Topsoil salinity test report.
- D. Erosion Control Matting catalogue cut sheets.

1.5 SEED TESTING REQUIREMENTS

- A. The seed weights noted indicate weight per acre in PLS and shall mean the total amount of fresh new crop seed per acre for all species listed. In the event that the seed supplier is unable to verify the percentage of PLS prior to installation, the supplier shall submit germination reports that identify the actual germination rates of each specified species. Based on these results, the Contractor shall provide supplemental seeding for each species that does not meet the specified rates of PLS.

1.6 QUALITY ASSURANCE

- A. Installer Qualifications: A qualified landscape Installer whose work has resulted in successful native prairie establishment.
 - 1. Installer's Field Supervision: Require Installer to maintain an experienced full-time supervisor on Project site when work is in progress.
 - 2. Pesticide Applicator: State licensed, commercial.

- B. Soil-Testing Laboratory Qualifications: An independent laboratory with the experience and capability to conduct the testing indicated and that specializes in types of tests to be performed. Refer to soil preparation specification for more information.
- C. Soil Analysis: For each unamended soil type, furnish soil analysis and a written report by a qualified soil-testing laboratory stating percentages of organic matter; gradation of sand, silt, and clay content; cation exchange capacity; deleterious material; pH; and mineral and plant-nutrient content of the soil.
 - 1. Testing methods and written recommendations shall comply with USDA's Handbook No. 60.
 - 2. The soil-testing laboratory shall oversee soil sampling, with depth, location, and number of samples to be taken per instructions from Engineer. A minimum of three representative samples shall be taken from varied locations for each soil to be used or amended for planting purposes.

PART 2 - PRODUCTS

2.1 SEED MIXTURES

- A. Fescue Lawn Low Maintenance Mix, manufactured by Native Connections or equal: Mix shall include four varieties of non-native tall fescues that are deeper rooted, more drought tolerant and slower growing. Tolerate full sun and part shade and a range of soil types.
 - 1. Hard Fescue (Nanook or equal), *Festuca brevipila*: 20% by weight.
 - 2. Sheep Fescue, *Festuca ovina*: 15% by weight.
 - 3. Chesings Fescue: *Festuca rubra commutata*: 35% by weight.
 - 4. Creeping Red Fescue: *Festuca rubra Arenaria*: 30% by weight.
- B. Seed mixtures for this project shall be consistent of the species makeup as indicated herein. Any substitutions of species must first be submitted to landscape architect for review and approval.

2.2 SEEDING CARRIERS

- A. If recommended by the seed supplier, seed carriers shall be coarse-screened dried sawdust no more than ¼ inch in size or approved equivalent. The seed carrier shall be completely dry to prevent it from becoming too heavy. The seed carrier shall be mixed with the small seed at a rate of 4 pounds of carrier to 1 pound of small seed. Large seed does not need a carrier.

2.3 PLANTING SOILS

- A. Refer to Soil Preparation specification for planting soil information.

2.4 EROSION CONTROL BLANKET

- A. Mulch Blankets (for low to moderate runoff conditions): Ensure erosion control blanket is made up of biodegradable material for all parts, including matrix, netting and thread. Photodegradable material will not be accepted. Mulch blankets shall be one of the following or an approved equal:
 - 1. Erosion Control Blankets SC-150BN – North American Green

PART 3 - EXECUTION

3.1 GENERAL ENVIRONMENTAL CONDITIONS

- A. Coordination is required to ensure rainfall does not result in soil moisture conditions that will cause excessive rutting during seeding operations. To meet this requirement, it may be necessary to seed portions of the site as the grading is completed. Failure to meet this requirement will not be an acceptable reason for not installing the seed as specified.
- B. Do not apply materials over snow or ice. Do not apply seeds, seed mixtures, or slurries with seeds when wind conditions are such that materials would be carried beyond designated areas or materials would not be uniformly applied. Do not undertake seeding and planting activities during stormy weather when excessive precipitation may result in washing of seeds and plantings away from location intended. Do not sow seed where standing water is present. Do not install plant materials during periods of temperature extremes when atmospheric temperature may drop below 36 degrees F or rise above 90 degrees F.
- C. Avoid soil compaction in planting zones as much as possible. Equipment access and travel should be routed around all planting areas, and repeat passes over the same area should be limited during all grading, topsoil application, and decompaction work. Equipment having low unit pressure ground contact should be utilized whenever possible. Prior to seeding, repair any ruts, rills or gullies greater than 2 inches in depth to create smooth continuous grades.

3.2 SEEDING EQUIPMENT

- A. Tractors and Crawlers. Shall have low-pressure flotation tires or broad tracks so that soil compaction is minimized in areas of site preparation or seeding activities.
- B. Disc. In good repair with sound unbroken blades; weighted, as necessary to achieve required tillage depth. To be used to break up hard packed soil as part of seedbed preparation.
- C. Rollers or Cultipackers. Minimum 6 inch diameter rollers; of sufficient weight to pulverize clods of soil. To be used following rough grading on subgrade soils as a preparation for installation of seedbed soils.
- D. Airway Shattertyne. Roller tynes shall be 10 to 12 inches OD so that topsoil or organic-rich common fill and surface mulches are mixed into top 2 to 4 inches of subgrade. Weighting of this equipment shall be minimal so as to avoid compaction of organic-rich common fill.
- E. Hydraulic Seeder. Hydraulic seeding equipment shall include a pump rated and operated at no less than 100 gpm and no less than 100 psi pressure. Tank shall have a mechanical agitator powerful enough to keep seed in suspension in mixture.
- F. Spinning Disc Seeder. When spinning disc seeders are used, mix individual seeds comprising mixture with an appropriate dispersal medium such as damp sterile sand or sawdust prior to sowing.
- G. Tractor-drawn or Mounted Seeders. Provide with a calibrated adjustable gate opening providing uniform flow over a width adapted to work and able to drop seed directly on prepared seedbed. Shall be made for native seed installation.

3.3 SEASONAL LIMITATIONS

- A. The seeding shall be completed from March 15 to June 1 or from September 15 to first frost. *Optimal* native species seeding time is October 1 through first frost to allow repeat freeze-thaw

cycles to incorporate the seed into the substrate and provide cold stratification to break seed dormancy. The seeding must be complete before June 15 or after September 15 of a given calendar year. Seeding shall not be performed during periods of any snow cover. Winter seeding may be allowed during periods of thaw prior to refreezing, providing that areas of snow are no longer present. Seed shall not be placed in areas of standing or moving water.

3.4 PREPARATION

- A. Protect structures, utilities, sidewalks, pavements, and other facilities, trees, shrubs, 100-year floodplain, wetlands, and plantings from damage caused by planting operations. Protect grade stakes set by others until directed to remove them.
- B. Install erosion-control measures to prevent erosion or displacement of soils and discharge of soil-bearing water runoff or airborne dust to adjacent properties, walkways, 100-year floodplain and wetlands.
- C. Moisten prepared area before planting if soil is dry. Water thoroughly and allow surface to dry before planting. Do not create muddy soil.
- D. Before planting, obtain Engineer's acceptance of finish grading; restore planting areas if eroded or otherwise disturbed after finish grading.

3.5 PREPARATION FOR BIODEGRADABLE EROSION-CONTROL MATERIALS

- A. For erosion-control mats, install planting soil in two lifts, with second lift equal to thickness of erosion-control mats. Install erosion-control mat and fasten as recommended by material manufacturer.
- B. Fill cells of erosion-control mat with planting soil and compact before planting.
- C. For erosion-control blanket or mesh, install from top of slope, working downward, and as recommended by material manufacturer for site conditions. Fasten as recommended by material manufacturer.
- D. Moisten prepared area before planting if surface is dry. Water thoroughly and allow surface to dry before planting. Do not create muddy soil.

3.6 TOPSOIL

- A. Unless otherwise called for on the plans, a minimum of three (3) inches of amended site topsoil shall be placed for areas that are to be restored with seeding. Topsoil shall be placed on a prepared earth bed in accordance with Section 81 6. 03A of the MDOT Standard Specifications for Construction.
- B. The existing earth bed shall be graded such that the placement of topsoil will meet the final plan grades.

3.7 SEED INSTALLATION

- A. Layout of seed bed edges shall be completed by the Contractor's surveyor locating the specified contour elevation shown on the plans. The Engineer reserves the right to adjust bed lines without adjusting total seeded area, to meet field conditions, at no additional cost to the City.

- B. Seed installation method(s) will be approved by the Engineer prior to seed installation. Seed installation method(s) selected shall insure complete coverage of the areas to be seeded. Seed installation methods selected shall be dependent on the season of installation (i.e., spring vs. fall) and shall be appropriate for the type of seed installed. If the seed is installed in the spring, large seed shall be installed with a no-till drill or, if one is not available, shall be broadcast followed by pressing the seed with a roller or cultipacker. If the seed is installed in the fall, the large seed may be broadcast without pressing since the frost heave experienced in the following winter will accomplish this. In no event shall the small seed be rolled or cultipacked since this seed requires surface sowing. Small seed shall be installed separately from the large seed and shall be mixed with a seed carrier to ensure proper distribution.
- C. Planting depth for seed mixes shall not be more than 1/4 inch deep. Native seeding shall be performed while the area is dry: either immediately following construction prior to inundation, or during periods of normal draw-down. Do not install seed during wind greater than 5 mph. Acceptable methods of native seed installation are listed below.
 - 1. Broadcast Seeding. Apply the seed uniformly over the surface using a tractor-mounted combination seeder/cultipacker unit (Brillion, Truax Trillion, or equal). The seeder shall be calibrated to uniformly apply the seed at the specified rate. A cone seeder or other similar broadcasting equipment may also be used. Seed shall be uniformly applied at the specified rates.
 - 2. Drill Seeding. A rangeland-type no-till drill (Truax, Tye, or equal) designed to plant native grasses and forbs may be used. The seeder shall be calibrated to uniformly apply the seed at the specified rates. Equipment shall be adjusted to prevent seed from being installed deeper than 1/4 inch into the soil.
 - 3. Hydroseeding. Hydroseeding equipment shall not be used to install native seed.
 - 4. Erosion Control Blanket. As called for in the specifications herein.

3.8 BIODEGRADABLE EROSION CONTROL BLANKET

- A. Biodegradable erosion control blankets shall be placed over seeded turf and prairie areas.
- B. ECB anchoring shall be considered as incidental to ECB placement.

3.9 RESTORATION

- A. Restore existing areas damaged by Contractor's operations, such as storage of materials or equipment and movement of vehicles.
 - 1. Reestablish areas where settlement or washouts occur or where minor regrading is required.
 - 2. Install new planting soil as required.
- B. Remove topsoil containing foreign materials such as oil drippings, fuel spills, stones, gravel, and other construction materials resulting from Contractor's operations, and replace with new planting soil.
- C. Mow, de-thatch, core aerate, and rake existing turf.
- D. Remove weeds before seeding. Where weeds are extensive, apply selective herbicides as required. Do not use pre-emergence herbicides.
- E. Remove waste and foreign materials, including weeds, soil cores, grass, vegetation, and turf, and legally dispose of them off Owner's property.
- F. Till stripped, bare, and compacted areas thoroughly to a soil depth of 6 inches.

- G. Apply soil amendments required for establishing new grass and prairie areas and mix thoroughly into salvaged topsoil. Install new planting soil to fill low spots and meet finish grades.
- H. Apply seed and protect with straw mulch or as required on the plans.
- I. Water newly planted areas and keep moist until new turf is established.

3.10 SEEDED LAWN AND NATIVE PRAIRIE MAINTENANCE

- A. It is the responsibility of the Contractor to regularly water new seed and sod in order to establish a dense groundcover of permanent grasses that is free from mounds and depressions. Any portion of a seeded area that “browns-out” or does not firmly knot to the soil base, or any portion of a seeded area that fails to show a uniform germination, shall be re-seeded. Such re-seeding shall be at the Contractor’s expense and shall continue until a dense lawn is established.
- B. Watering seed and sod shall be considered as included in the turf establishment work.
- C. Maintain and establish grass by watering, fertilizing, weeding, mowing, trimming, replanting, and performing other operations as required to establish healthy, viable turf. Roll, regrade, and replant bare or eroded areas and remulch to produce a uniformly smooth turf. Provide materials and installation the same as those used in the original installation.
 - 1. Fill in as necessary soil subsidence that may occur because of settling or other processes. Replace materials and turf damaged or lost in areas of subsidence.
 - 2. Apply natural treatments as required to keep grass and soil free of pests and pathogens or disease. Use integrated pest management practices whenever possible to minimize the use of pesticides and reduce hazards.
- D. Watering: Install and maintain temporary piping, hoses, and turf-watering equipment to convey water from sources and to keep turf uniformly moist to a depth of 4 inches.
 - 1. Schedule watering to prevent wilting, puddling, erosion, and displacement of seed or mulch. Lay out temporary watering system to avoid walking over muddy or newly planted areas.
 - 2. Water turf with fine spray at a minimum rate of 1-inch per week unless rainfall precipitation is adequate.
- E. Mow seeded lawn as soon as top growth is tall enough to cut. Repeat mowing to maintain specified height without cutting more than 1/3 of grass height. Remove no more than 1/3 of grass-leaf growth in initial or subsequent mowings. Do not delay mowing until grass blades bend over and become matted. Do not mow when grass is wet.

3.11 SATISFACTORY NATIVE SEED PERFORMANCE STANDARDS

- A. The Contractor shall warrant all seed to be true to botanical name.
- B. The Contractor will not be responsible for defects resulting from neglect by the Owner, abuse or damage by others, or unusual phenomena or incidents beyond the Landscape Installer’s control which result from natural causes such as floods, lightning, storms, freezing rains, severe predation, winds over 60 miles per hour (mph), fires or vandalism.
- C. The Contractor shall establish a dense cover of herbaceous species on all native-seeded areas required to be seeded under the Contract. The Engineer will conduct a field inspection of all seeded areas at the end of the first and second full growing seasons. Final acceptance will be granted at the end of the second full growing season.
 - 1. Areas which do not meet the contract requirements shall be reseeded within acceptable planting dates as directed by the Engineer.

2. The Engineer will conduct a time meander search during the field inspections. This procedure consists of a random search of 20 percent of the seeded areas. Acceptance will be granted if the seeded areas meet the following parameters: 80 percent of species seeded are present with 90 percent total cover, and any bare areas 100 square feet in size or greater shall be reseeded. These areas shall be reseeded as originally specified at no additional cost to the Owner.

3.12 CLEANING, REMOVAL AND RESTORATION

- A. Upon completion of seed installation, remove from the site and legally dispose of all trash and debris including any material removed during grade preparation. Restore existing wetland and upland areas damaged by operations under the contract. Restoration shall include finish grading and seeding as required to match existing grade and/or wetlands, and maintenance of restored areas. Any damage by the Contractor to established or newly seeded areas not within the project scope of work shall be repaired and reseeded at no cost to the Owner.

3.13 SEEDED LAWN MAINTENANCE

- A. Maintain and establish seeded lawn and prairie areas by watering, weeding, mowing, trimming, replanting, and performing other operations as required to establish a healthy, viable meadow. Roll, regrade, and replant bare or eroded areas and remulch. Provide materials and installation the same as those used in the original installation.
 1. Fill in as necessary soil subsidence that may occur because of settling or other processes. Replace materials and meadow damaged or lost in areas of subsidence.
 2. In areas where mulch has been disturbed by wind or maintenance operations, add new mulch and anchor as required to prevent displacement.
 3. Apply treatments as required to keep restored area and soil free of pests and pathogens or disease. Use integrated pest management practices whenever possible to minimize the use of pesticides and reduce hazards.
- B. Watering: Install and maintain temporary piping, hoses, and watering equipment to convey water from sources and to keep seeded area uniformly moist.
 1. Schedule watering to prevent wilting, puddling, erosion, and displacement of seed or mulch. Lay out temporary watering system to avoid walking over muddy or newly planted areas.

3.14 SEEDED PRAIRIE MAINTENANCE

- A. Maintain and establish native seed by watering, weeding, mowing, trimming, replanting, and performing other operations as required to establish a healthy, viable meadow. Roll, regrade, and replant bare or eroded areas and remulch. Provide materials and installation the same as those used in the original installation.
 1. Fill in as necessary soil subsidence that may occur because of settling or other processes. Replace materials and meadow damaged or lost in areas of subsidence.
 2. In areas where mulch has been disturbed by wind or maintenance operations, add new mulch and anchor as required to prevent displacement.
 3. Apply treatments as required to keep restored area and soil free of pests and pathogens or disease. Use integrated pest management practices whenever possible to minimize the use of pesticides and reduce hazards.
- B. Watering: Install and maintain temporary piping, hoses, land meadow-watering equipment to convey water from sources and to keep meadow uniformly moist.
 1. Schedule watering to prevent wilting, puddling, erosion, and displacement of seed or mulch. Lay out temporary watering system to avoid walking over muddy or newly planted areas.

3.15 HERBICIDE APPLICATION

- A. Where feasible, physical hand weeding and mowing per seed manufacturer recommendations shall take precedence over herbicide applications. Where herbicide may be needed, approval is required by landscape architect prior to applying herbicide.
- B. Apply herbicides and other chemical products and biological control agents in accordance with requirements of authorities having jurisdiction and manufacturer's written recommendations. Coordinate applications with Owner's operations and others in proximity to the Work. Notify Owner before each application is performed.
- C. Post-Emergent Herbicides (Selective and Non-Selective): Apply only as necessary to treat already-germinated weeds and in accordance with manufacturer's written recommendations.

3.16 CLEANUP AND PROTECTION

- A. Promptly remove soil and debris created by restoration work from paved areas. Clean wheels of vehicles before leaving site to avoid tracking soil onto roads, walks, or other paved areas.
- B. Erect temporary fencing or barricades and warning signs as required to protect newly planted areas from traffic. Maintain fencing and barricades throughout initial maintenance period and remove after plantings are established.
- C. Remove non-degradable erosion-control measures after grass establishment period.

3.17 PROGRESS OF FINAL RESTORATION

- A. If in the judgment of the Owner, adequate site restoration efforts are not being expended, then the Owner will take the necessary steps to perform such restoration and shall charge the Contractor for all of the costs until proper order is restored.

END OF SECTION 32 92 00

SECTION 40 05 07 - HANGERS AND SUPPORTS FOR PROCESS PIPING

PART 1 - GENERAL

1.1 SUMMARY

A. Section Includes:

1. Pipe hangers and supports.
2. Hanger rods.
3. Structural attachments.
4. Pipe guides.
5. Formed steel channel.

B. Related Requirements:

1. Section 03 30 00 - Cast-in-Place Concrete: Execution requirements for placement of concrete housekeeping pads specified by this Section.
2. Section 09 92 00 – Facility Painting: Product and execution requirements for painting specified by this Section.
3. Section 40 05 19 – Ductile Iron Process Piping: Execution requirements for placement of hangers and supports specified by this Section.
4. Section 40 05 23 - Common Work Results for Process Valves: Common product requirements for valves for placement by this Section.

1.2 REFERENCE STANDARDS

A. American Society of Mechanical Engineers:

1. ASME B31.1 - Power Piping.
2. ASME B31.9 - Building Services Piping.

B. ASTM International:

1. ASTM A36 - Standard Specification for Carbon Structural Steel.
2. ASTM A36M - Standard Specification for Carbon Structural Steel.
3. ASTM A47 - Standard Specification for Ferritic Malleable Iron Castings.
4. ASTM A47M - Standard Specification for Ferritic Malleable Iron Castings.
5. ASTM A576 - Standard Specification for Steel Bars, Carbon, Hot-Wrought, Special Quality.
6. ASTM A181 - Standard Specification for Carbon Steel Forgings, for General-Purpose Piping.
7. ASTM A181M - Standard Specification for Carbon Steel Forgings, for General-Purpose Piping.

C. American Welding Society:

1. AWS D1.1 - Structural Welding Code Steel - Reference Manual.

D. Manufacturers Standardization Society of the Valve and Fittings Industry:

1. MSS SP-58 - Pipe Hangers and Supports - Materials, Design, Manufacturer, Selection, Application, and Installation.

1.3 COORDINATION

A. Section 01 31 00 – Project Management and Coordination: Requirements for coordination.

B. Coordinate Work of this Section with piping and equipment connections specified in other Sections and indicated on Drawings.

1.4 PREINSTALLATION MEETINGS

- A. Section 01 31 00 – Project Management and Coordination: Requirements for preinstallation meeting.
- B. Convene minimum one week prior to commencing Work of this Section.

1.5 SUBMITTALS

- A. Section 01 33 00 - Submittal Procedures: Requirements for submittals.
- B. Product Data: Submit manufacturer's catalog data including load capacity.
- C. Shop Drawings: Indicate system layout with location - including critical dimensions, sizes, and pipe hanger and support locations - and detail of trapeze hangers, anchors, and guides.
- D. Manufacturer's Certificate: Certify that products meet or exceed specified requirements.
- E. Manufacturers' Instructions: Submit special procedures and assembly of components.
- F. Qualifications Statements:
 - 1. Submit qualifications for manufacturer, fabricator, installer, and licensed professional.
 - 2. Submit manufacturer's approval of installer.

1.6 MAINTENANCE MATERIAL SUBMITTALS

- A. Section 01 78 23 – Operation and Maintenance Data: Requirements for maintenance materials.
- B. Spare Parts:
 - 1. Furnish one set of manufacturer's recommended spare parts.
- C. Tools: Furnish special wrenches and other devices required for Owner to maintain.

1.7 QUALITY ASSURANCE

- A. Perform Work according to applicable authority or AWS D1.1 for welding hanger and support attachments to building structure.

1.8 QUALIFICATIONS

- A. Manufacturer: Company specializing in manufacturing Products specified in this Section with minimum three years' documented experience.
- B. Fabricator: Company specializing in fabricating products specified in this Section with minimum three years' documented experience.
- C. Installer: Company specializing in performing Work of this Section with minimum three years' documented experience.

1.9 DELIVERY, STORAGE, AND HANDLING

- A. Section 01 60 00 - Product Requirements: Requirements for transporting, handling, storing, and protecting products.

- B. Inspection: Accept materials on-Site in original factory packaging, labeled with manufacturer's identification.
- C. Protect products from weather and construction traffic, dirt, water, chemical, and damage by storing in original packaging.

1.10 AMBIENT CONDITIONS

- A. Section 01 50 00 - Temporary Facilities and Controls: Requirements for ambient condition control facilities for product storage and installation.
- B. Provide ventilation in areas receiving solvent-cured materials.

1.11 EXISTING CONDITIONS

- A. Field Measurements: Verify field measurements prior to fabrication. Indicate field measurements on Shop Drawings.

1.12 WARRANTY

- A. Section 01 77 00 - Closeout Procedures: Requirements for warranties.
- B. Furnish one-year manufacturer's warranty for pipe hangers and supports.

PART 2 - PRODUCTS

2.1 PIPE HANGERS AND SUPPORTS

- A. Manufacturers:
 - 1. Grinnel Mechanical Products.
 - 2. Substitutions: Section 01 60 00 - Product Requirements.
- B. Description:
 - 1. Conform to ASME B31.1.
 - 2. Provide means of vertical adjustment after erection.
 - 3. Pipe Sizes 1/2 to 1-1/2 in: ASTM A47, malleable iron, adjustable swivel, split ring.
 - 4. Pipe Sizes 2 in and Larger: ASTM A36, steel, adjustable, clevis.
 - 5. Multiple or Trapeze Hangers: Steel channels with welded spacers and hanger rods.
 - 6. Wall Support for Pipe Sizes 3 in and Smaller: Cast iron J-hook.
 - 7. Wall Support for Pipe Sizes 4 in and Larger: Welded steel bracket.
 - 8. Vertical Support: Riser clamp.
 - 9. Floor Supports: Cast iron adjustable pipe saddle, lock nut, nipple, floor flange, and concrete pier or steel support.
- C. Performance and Design Criteria:
 - 1. Pipe Hangers:
 - a. Allow for expansion and contraction of piping while eliminating undue stress on piping appurtenances and equipment.
 - b. Provide linkage to permit lateral or axial movement where anticipated.
 - c. Where horizontal pipe movement is greater than 1/2 in, or where hanger rod deflection from the vertical is greater than 4 degrees from cold to hot position of pipe, hanger rod and structural attachment shall be offset to maintain rod vertical in hot position.
 - 2. Heat Transmission: Design supports, hangers, anchors, and guides to prevent excessive heat from being transmitted to building structure, equipment, or piping appurtenances.

3. Riser Supports: Support risers on each floor with riser clamps and lugs, independent of connected horizontal piping.
4. Point Loads:
 - a. Support plastic piping containing meters, valves, appurtenances, and other point loads on both sides.
 - b. Avoid point loads on plastic piping by providing extra wide pipe saddles or galvanized steel shields.

2.2 HANGER RODS

A. Hanger Rods:

1. ASTM A576, steel.
2. Threaded both ends.
3. Diameter: ASME B31.1.

2.3 STRUCTURAL ATTACHMENTS

A. Manufacturers:

1. Grinnel Mechanical Products
2. Substitutions: Section 01 60 00 - Product Requirements.

B. Concrete Inserts:

1. Manufacturers:
 - a. National Pipe Hanger Corporation.
 - b. Substitutions: Section 01 60 00 - Product Requirements.
2. Description:
 - a. Malleable iron case of galvanized steel shell and expander plug for threaded connection with lateral adjustment, top slot for reinforcing rods, lugs for attaching to forms.
 - b. Size inserts to suit threaded hanger rods.

C. Mounting Brackets: ASTM A36, welded steel.

D. Beam Clamps:

1. Manufacturers:
 - a. Grinnel Mechanical Products.
 - b. Substitutions: Section 01 60 00 - Product Requirements.
2. ASTM A181, forged steel; MSS SP-58.
3. Clamp Size: Based on load to be supported and load configuration.
4. Anchoring: Locknuts and cup-point set screws.
5. Reversible top or bottom flange.

E. Riser Clamps:

1. Manufacturers:
 - a. Grinnel Mechanical Products.
 - b. Substitutions: Section 01 60 00 - Product Requirements.
2. ASTM A36, steel.
3. Support of Copper Tubing: Provide copper-plated clamps.

F. Offset Clamps:

1. Manufacturers:
 - a. Grinnel Mechanical Products.
 - b. Substitutions: Section 01 60 00 - Product Requirements.
2. Double leg, two-piece.

2.4 PIPE GUIDES

A. Intermediate Guides:

1. Pipes 6 in and Smaller: Pipe clamp with oversize pipe sleeve.
2. Pipes 8 in and Larger: U-bolts with double nuts.

B. Alignment Guides:

1. Pipes 8 in and Smaller: Galvanized steel Sleeve type.
2. Pipes 10 in and Larger: Galvanized steel Roller type.

PART 3 - EXECUTION

3.1 EXAMINATION

- A. Section 01 30 00 - Administrative Requirements: Requirements for installation examination.
- B. Verify field dimensions as indicated on Drawings.

3.2 INSTALLATION

- A. Powder-actuated anchors shall not be used.
- B. Powder-driven fasteners shall not be used in precast concrete.
- C. Do not drill or cut structural members.
- D. Inserts:
 1. Install inserts for placement in concrete forms.
 2. Install inserts for suspending hangers from reinforced concrete slabs and sides of reinforced concrete beams.
 3. Provide hooked rod to concrete reinforcement section for inserts carrying pipe 4 in and larger.
 4. Where concrete slabs form finished ceiling, locate inserts flush with slab surface.
 5. Where inserts are omitted, drill through concrete slab from below and provide through-bolt with recessed square steel plate and nut recessed into and grouted flush with slab.
- E. Pipe Hangers and Supports:
 1. Install according to: ASME B31.1.
 2. Support horizontal piping as indicated on Drawings.
 3. Install hangers with minimum 1/2 in space between finished covering and adjacent Work.
 4. Place hangers within 12 in of each horizontal elbow.
 5. Use hangers with 1-1/2 in minimum vertical adjustment.
 6. Support horizontal cast iron pipe adjacent to each hub, with 5 ft maximum spacing between hangers.
 7. Support vertical piping at every floor. Support vertical cast iron pipe at each floor at hub.
 8. Where piping is installed in parallel and at same elevation, provide multiple pipe or trapeze hangers.
 9. Support riser piping independently of connected horizontal piping.
 10. Provide sheet lead packing between hanger or support and piping.
 11. Design hangers for pipe movement without disengagement of supported pipe.
 12. Support piping independently so that equipment is not stressed by piping weight or expansion in piping system.
 13. Provide welded steel brackets where piping is to be run adjacent to building walls or columns.

14. Use beam clamps where piping is to be suspended from building steel.
15. Insulated Piping: Provide two bolted clamps designed to accommodate insulated piping.
16. Use offset clamps where pipes are indicated as offset from wall surfaces.

F. Insulation:

1. Provide clearance in hangers and from structure and other equipment for installation of insulation.
2. Conform to Section 22 07 00 - Plumbing Insulation.

G. Equipment Bases and Supports:

1. Provide housekeeping pads as detailed on Drawings.
2. Using templates furnished with equipment, install anchor bolts and accessories for mounting and anchoring equipment.
3. Construct supports of steel members. Brace and fasten with flanges bolted to structure.
4. Provide rigid anchors for pipes after vibration isolation components are installed. Comply with Section 40 05 13 - Common Work Results for Process Piping.

H. Prime Coat:

1. Prime coat exposed steel hangers and supports.
2. Conform to Section 09 90 00 - Painting and Coating.
3. Hangers and supports located in crawl spaces, pipe shafts, and suspended ceiling spaces are not considered exposed.

3.3 ATTACHMENTS

A. Pipe Hanger Spacing:

1. Pipe Material: ABS.
 - a. Maximum Hanger Spacing: 4 feet
 - b. 3/8 inch
2. Pipe Material: Aluminum.
 - a. Maximum Hanger Spacing: 10 feet
 - b. 1/2 inch
3. Pipe Material: Cast iron.
 - a. Maximum Hanger Spacing: 5 feet
 - b. 5/8 inch
4. Pipe Material: Cast Iron, with 10-foot length of pipe.
 - a. Maximum Hanger Spacing: 10 feet
 - b. 5/8 inch
5. Pipe Material: CPVC.
 - a. Size: 1 inch and smaller.
 - b. Maximum Hanger Spacing: 3 feet
 - c. 1/2 inch
6. Pipe Material: CPVC.
 - a. Size: 1-1/4 inches and larger.
 - b. Maximum Hanger Spacing: 4 feet
 - c. 1/2 inch
7. Pipe Material: Copper tube.
 - a. Size: 1-1/4 inches and smaller.
 - b. Maximum Hanger Spacing: 6 feet
 - c. 1/2 inch
8. Pipe Material: Copper tube.
 - a. Size: 1-1/2 inches and larger.
 - b. Maximum Hanger Spacing: 10 feet
 - c. 1/2 inch

9. Pipe Material: Fiberglass:
 - a. Maximum Hanger Spacing: 4 feet
 - b. 1/2 inch
10. Pipe Material: Glass.
 - a. Maximum Hanger Spacing: 8 feet
 - b. 1/2 inch
11. Pipe Material: Polybutylene.
 - a. Maximum Hanger Spacing: 2.7 feet
 - b. 3/8 inch
12. Pipe Material: Polypropylene.
 - a. Maximum Hanger Spacing: 4 feet
 - b. 3/8 inch
13. Pipe Material: PVC.
 - a. Maximum Hanger Spacing: 4 feet
 - b. 3/8 inch
14. Pipe Material: Steel.
 - a. Size: 3 inches and smaller.
 - b. Maximum Hanger Spacing: 12 feet
 - c. 1/2 inch
15. Pipe Material: Steel.
 - a. Size: 4 inches and larger.
 - b. Maximum Hanger Spacing: 12 feet
 - c. 5/8 inch

END OF SECTION 40 05 07

SECTION 40 05 51 - COMMON REQUIREMENTS FOR PROCESS VALVES

PART 1 - GENERAL

1.1 SUMMARY

A. Section Includes:

1. Valves.
2. Valve actuators.

B. Related Requirements:

1. Section 03 30 00 - Cast-in-Place Concrete: Execution requirements for placement of concrete as required by this Section.
2. Section 09 92 00 – Facility Painting: Product and execution requirements for painting specified by this Section.
3. Section 40 05 07 - Hangers and Supports for Process Piping: Product and execution requirements for valve supports specified by this Section.

1.2 REFERENCE STANDARDS

A. American Water Works Association:

1. AWWA C541 - Hydraulic and Pneumatic Cylinder and Vane-Type Actuators for Valves and Slide Gates.
2. AWWA C542 - Electric Motor Actuators for Valves and Slide Gates.
3. AWWA C550 - Protective Interior Coatings for Valves and Hydrants.

B. ASTM International:

1. ASTM B62 - Standard Specification for Composition Bronze or Ounce Metal Castings.
2. ASTM B584 - Standard Specification for Copper Alloy Sand Castings for General Applications.

C. Manufacturers Standardization Society:

1. MSS SP-25 - Standard Marking System for Valves, Fittings, Flanges, and Unions.

D. National Electrical Manufacturers Association:

1. NEMA 250 - Enclosures for Electrical Equipment (1000 Volts Maximum).

E. NFPA:

1. NFPA 70 - National Electrical Code (NEC).

F. NSF International:

1. NSF 61 - Drinking Water System Components - Health Effects.
2. NSF 372 - Drinking Water System Components - Lead Content.

G. UL:

1. Equipment Directory.

1.3 COORDINATION

A. Section 01 31 00 – Project Management and Coordination: Requirements for coordination.

B. Coordinate Work of this Section with piping, equipment, and appurtenances.

1.4 PREINSTALLATION MEETINGS

- A. Section 01 31 00 – Project Management and Coordination: Requirements for preinstallation meeting.
- B. Convene minimum one week prior to commencing Work of this Section.

1.5 SUBMITTALS

- A. Section 01 33 00 - Submittal Procedures: Requirements for submittals.
- B. Product Data:
 - 1. Submit manufacturer information for actuator with model number and size indicated.
 - 2. Submit valve cavitation limits.
- C. Shop Drawings: Indicate parts list, materials, sizes, position indicators, limit switches, control system, actuator mounting, wiring diagrams, control system schematics.
- D. Valve-Labeling Schedule: Indicate valve locations and nametag text.
- E. Manufacturer's Certificate: Certify that products meet or exceed specified requirements.
- F. Manufacturer Instructions: Submit installation instructions and special requirements.
- G. Source Quality-Control Submittals: Indicate results of factory tests and inspections.
- H. Field Quality-Control Submittals: Indicate results of Contractor-furnished tests and inspections, including factory-applied coatings.
- I. Manufacturer Reports: Certify that equipment has been installed according to manufacturer instructions.
- J. Qualifications Statement:
 - 1. Submit qualifications for manufacturer and licensed professional.

1.6 CLOSEOUT SUBMITTALS

- A. Section 01 70 00 - Execution and Closeout Requirements: Requirements for submittals.
- B. Project Record Documents: Record actual locations of valves and actuators.

1.7 QUALITY ASSURANCE

- A. Maintain clearances as indicated on Drawings.
- B. Ensure that materials of construction of wetted parts are compatible with process liquid.
- C. Materials in Contact with Potable Water: Certified to NSF 61 and NSF 372.
- D. Perform Work according to applicable standards.
- E. Maintain copies of each standard affecting Work of this Section on Site.

1.8 QUALIFICATIONS

- A. Manufacturer: Company specializing in manufacturing products specified in this Section with minimum three years' documented experience.

1.9 DELIVERY, STORAGE, AND HANDLING

- A. Section 01 60 00 - Product Requirements: Requirements for transporting, handling, storing, and protecting products.
- B. Inspection: Accept materials on Site in manufacturer's original packaging and inspect for damage.
- C. Store materials according to manufacturer instructions.
- D. Protection:
 - 1. Protect materials from moisture and dust by storing in clean, dry location remote from construction operations areas.
 - 2. Protect valve ends from entry of foreign materials by providing temporary covers and plugs.
 - 3. Provide additional protection according to manufacturer instructions.

1.10 EXISTING CONDITIONS

- A. Field Measurements:
 - 1. Verify field measurements prior to fabrication.
 - 2. Indicate field measurements on Shop Drawings.

1.11 WARRANTY

- A. Section 01 77 00 - Closeout Procedures: Requirements for warranties.
- B. Furnish one-year manufacturer's warranty for valves and actuators.

PART 2 - PRODUCTS

2.1 VALVES

- A. Description: Valves, operator, actuator, handwheel, chainwheel, extension stem, floor stand, worm and gear operator, operating nut, chain, wrench, and other accessories as required.
- B. Valve Ends: Compatible with adjacent piping system.
- C. Operation:
 - 1. Open by turning counterclockwise; close by turning clockwise.
 - 2. Cast directional arrow on valve or actuator with OPEN and CLOSE cast on valve in appropriate location.
- D. Valve Marking and Labeling:
 - 1. Marking: Comply with MSS SP-25.
 - 2. Labeling: As specified in Section 40 05 13 - Common Work Results for Process Piping and valve schedule.
 - 3. Provide buried valves with valve boxes, covers, and extensions.

- E. Valve Construction:
 - 1. Bodies: Rated for maximum temperature and pressure to which valve will be subjected as specified in valve Sections.
 - 2. Bonnets:
 - a. Flanged to body and of same material and pressure rating as body.
 - b. Furnish glands, packing nuts, or yokes as specified in valve Sections.
 - 3. Stems and Stem Guides:
 - a. Materials and Seals: As specified in valve Sections.
 - b. Bronze Valve Stems: According to ASTM B584.
 - c. Space stem guides 10 feet o.c.
 - d. Submerged Stem Guides: Type 304 stainless steel.
 - 4. Nuts and Bolts: As specified in Section 05 50 00 - Metal Fabrications.

2.2 VALVE ACTUATORS

- A. Provide actuators with position indicators for shutoff valves 6 inches and larger.
- B. Comply with AWWA C541.
- C. Provide chain actuators for shutoff valves mounted 8 feet above operating floor level.
- D. Provide gear and power actuators with position indicators.
- E. Gear-Assisted Manual Actuators:
 - 1. Provide totally enclosed gears.
 - 2. Maximum Operating Force: 60 lbf.
 - 3. Bearings: Permanently lubricated bronze.
 - 4. Packing: Accessible for adjustment without requiring removal of actuator from valve.
- F. Chain Actuator:
 - 1. Description: Chain guides and hot-dip galvanized operating chain extending to 5-1/2 feet above operating floor level.
 - 2. Chain Wheels: Sprocket-rim type.
 - 3. Furnish chain storage if chains may interfere with pedestrian traffic.
- G. Valve Actuators in NEC Class I, Group D, Division 1 or 2 Hazardous Locations: UL approved.
- H. Accessories:
 - 1. Handwheel:
 - a. Furnish permanently attached handwheel for emergency manual operation.
 - b. Rotation: None during powered operation.
 - c. Permanently affix directional arrow and cast OPEN and CLOSE on handwheel to indicate appropriate direction to turn handwheel.
 - d. Maximum Operating Force: 60 lbf.

2.3 INSULATION

- A. As indicated on Drawings in pipe schedule.

2.4 FINISHES

- A. Valve Lining and Coating: Comply with AWWA C550.
- B. Exposed Valves: As specified in Section 09 92 00 – Facility Painting.

C. Do not coat flange faces of valves unless otherwise specified.

2.5 SOURCE QUALITY CONTROL

A. Section 01 40 00 - Quality Requirements: Requirements for testing, inspection, and analysis.

B. Testing: Test valves according to manufacturer's standard testing protocol, including hydrostatic, seal, and performance testing.

C. Owner Inspection:

1. Make completed available for inspection at manufacturer's factory prior to packaging for shipment.
2. Notify Owner at least fourteen days before inspection is allowed.

D. Certificate of Compliance:

1. If manufacturer is approved by authorities having jurisdiction, submit certificate of compliance indicating Work performed at manufacturer's facility conforms to Contract Documents.
2. Specified shop tests are not required for Work performed by approved manufacturer.

PART 3 - EXECUTION

3.1 EXAMINATION

A. Section 01 31 00 – Project Management and Coordination: Requirements for installation examination.

B. Verify that piping system is ready for valve installation.

3.2 INSTALLATION

A. Install valves, actuators, extensions, valve boxes, and accessories according to manufacturer instructions.

B. Firmly support valves to avoid undue stresses on piping.

C. Coat studs, bolts and nuts with anti-seizing lubricant.

D. Clean field welds of slag and splatter to provide a smooth surface.

E. Install valves with stems upright or horizontal, not inverted.

F. Install brass male adapters on each side of valves in copper-piped system and solder adapters to pipe.

G. Install 3/4-inch ball valves with cap for drains at main shutoff valves, low points of piping, bases of vertical risers, and equipment.

H. Install valves with clearance for installation of insulation and to allow access.

I. Provide access where valves and fittings are not accessible.

J. Pipe Hangers and Supports: As specified in Section 40 05 07 - Hangers and Supports for Process Piping.

K. Comply with Division 40 - Process Interconnections for piping materials applying to various system types.

L. Install insulation as indicated on Drawings in pipe schedule.

M. Valve Applications:

1. Install shutoff and drain valves at locations as indicated on Drawings and as specified in this Section.
2. Install shutoff and isolation valves.
3. Isolate equipment, part of systems, or vertical risers as indicated on Drawings.
4. Install valves for throttling, bypass, or manual flow control services as indicated on Drawings.
5. Install ball, and gate valves in water systems for shutoff service.
6. Install ball, butterfly, and gate valves in sanitary systems for shutoff service.

3.3 FIELD QUALITY CONTROL

A. Section 01 40 00 - Quality Requirements: Requirements for inspecting and testing.

B. Valve Field Testing:

1. Test for proper alignment.
2. If specified by valve Section, field test equipment to demonstrate operation without undue noise, vibration, or overheating.
3. Architect/Engineer will witness field testing.

3.4 ATTACHMENTS

A. Valve Schedule: Provide in accordance with Drawings in Valve Schedule.

END OF SECTION 40 05 51

SECTION 40 05 67.39 - PRESSURE-RELIEF VALVES

PART 1 - GENERAL

1.1 SUMMARY

- A. Section Includes:
 - 1. Floor type, Hydrostatic pressure-relief valves.
- B. Related Requirements:
 - 1. Section 01 22 00 – Unit Prices
 - 2. Section 01 10 00 – Summary
 - 3. Section 02 41 19 – Concrete Reservoir Maintenance
 - 4. Section 03 30 00 - Cast-In-Place Concrete.

1.2 Section 03 30 00 - Cast-In-Place Concrete REFERENCE STANDARDS

- A. ASME International:
 - 1. ASME B16.5 - Pipe Flanges and Flanged Fittings: NPS 1/2 through NPS 24 Metric/Inch Standard.
- B. ASTM International:
 - 1. ASTM A126 – Standard Specification for Gray Iron Castings for Valves, Flanges and Pipe Fittings.
 - 2. ASTM A276 - Standard Specification for Stainless Steel Bars and Shapes.
 - 3. ASTM B584 - Standard Specification for Copper Alloy Sand Castings for General Applications.
 - 4. ASTM D2000 - Standard Classification System for Rubber Products in Automotive Applications.

1.3 COORDINATION

- A. Section 01 31 00 - Project Management and Coordination: Requirements for coordination.
- B. Coordinate Work of this Section with installation of concrete or process tanks.

1.4 SUBMITTALS

- A. Section 01 33 00 - Submittal Procedures: Requirements for submittals.
- B. Product Data: Submit manufacturer catalog information.
- C. Shop Drawings: Indicate materials, size and accessories. For installation in concrete structures, critical dimensions and field measurements are required.
- D. Manufacturer's Certificate: Certify that products meet or exceed specified requirements.
- E. Manufacturer Instructions: Submit special procedures and setting dimensions.
- F. Qualifications Statement:
 - 1. Submit qualifications for manufacturer.
 - 2. Manufacturer shall have a minimum 10 years manufacturing experience with floor and wall pressure relief valves and shall show evidence of satisfactory operation in at least 5 installations, if requested by Engineer.

1.5 CLOSEOUT SUBMITTALS

- A. Section 01 77 00 - Closeout Procedures: Requirements for submittals.
- B. Section 01 78 39 Project Record Documents: Record actual locations of pressure-relief valves.
- C. Section 01 78 23 - Operation and Maintenance Data: Submit maintenance instructions for equipment and accessories.

1.6 QUALITY ASSURANCE

1.7 QUALIFICATIONS

- A. Manufacturer: Company specializing in manufacturing products specified in this Section with minimum ten years' documented experience.

1.8 DELIVERY, STORAGE, AND HANDLING

- A. Section 01 60 00 - Product Requirements: Requirements for transporting, handling, storing, and protecting products.
- B. Inspection: Accept materials on Site in manufacturer's original packaging and inspect for damage.
- C. Store materials according to manufacturer instructions.
- D. Protection:
 - 1. Protect materials from moisture and dust by storing in clean, dry location remote from construction operations areas.
 - 2. Furnish temporary end caps and closures on piping and fittings and maintain in place until installation.
 - 3. Provide additional protection according to manufacturer instructions.

1.9 EXISTING CONDITIONS

- A. Field Measurements:
 - 1. Verify field measurements prior to fabrication.
 - 2. Indicate field measurements on Shop Drawings.

1.10 WARRANTY

- A. Section 01 77 00 - Closeout Procedures: Requirements for warranties.

PART 2 - PRODUCTS

2.1 FLOOR TYPE PRESSURE-RELIEF VALVES, HYDROSTATIC

- A. Manufacturers:
 - 1. Clow Valve Company, Model F-1493-T.
 - 2. Kennedy Valve, Model F-1493.
 - 3. M&H Valve Company, Model F-1493.
 - 4. ~~Neenah Series R-5000.~~
 - 5. ~~Troy Valve a division of Penn-Troy Manufacturing Inc., Model A2550RSN.~~
 - 6. Substitutions: Not permitted.

- B. Description:
1. Size: 4 inches.
 2. General:
 - a. Floor type hydrostatic pressure valves shall be installed in existing or new slabs to relieve ground water pressure from the underside of the slab.
 - b. Valves shall be installed with a crushed stone sump under the valve and up to the underside of the removable grate to allow groundwater to pass through the valve and into the tank.
 - c. Cover and grate are removable by turning to the right or left and lifting out.
 - d. Cover or grate cannot be separated from valve body by the ground water pressure.
 - e. The valve will start to open at 9 inches of water pressure.
 - f. Floor type hydrostatic valves shall be installed in the vertical position.
 - g. Valve body shall have an integrally cast waterstop to prevent water from travelling around the outside of the valve.
 - h. Valves shall be supplied to the exact length of the slab thickness required to avoid field cutting. If extension is required, the valve body shall be designed to be extended to any length by using C900 PVC pipe and cutting to the required length.
 3. Materials:
 - a. Body: Cast Iron A126B.
 - b. Cover: Cast Iron A126B.
 - c. Removable Grate: Cast Iron A126B.
 - d. Seal: Buna-N, 50 Durometer.
 - e. Seat: Machined Bronze, SAE660.
 - 1) Rubber to rubber seals are not acceptable.
 - f. Body Extension: PVC C900.
 - g. O-Ring: Buna-N, 60 Durometer.
- C. Accessories:
1. Flange bolts and gasket.
 2. Where required, the manufacturer shall provide valve operating stems, floor stands and stem guides as specified in the Valve Schedule or as shown on the Drawings.

2.2 SOURCE QUALITY CONTROL

- A. Provide shop inspection and testing of completed assembly.
- B. Certificate of Compliance:
1. If manufacturer is approved by authorities having jurisdiction, submit certificate of compliance indicating Work performed at manufacturer's facility conforms to Contract Documents.
 2. Specified shop tests are not required for Work performed by approved manufacturer.

PART 3 - EXECUTION

3.1 EXAMINATION

- A. Section 01 31 00 – Project Management and Coordination: Requirements for installation examination and pre-installation conference.
- B. Verify that field dimensions are as indicated on Shop Drawings.

3.2 PREPARATION

- A. Section 01 73 00 - Execution: Requirements for installation preparation.

- B. Thoroughly clean end connections before installation.
- C. Cleaning: Clean surfaces to remove foreign substances.

3.3 INSTALLATION

- A. According to manufacturer instructions and local code requirements.
- B. Repair damaged coatings with material equal to original coating.
- C. Floor type pressure relief valves shall be exercised by raising and lowering the flap so the pin can be checked for free operation. Lubricate the hinge/shaft pin with a food grade grease similar to Mystik FG-2 or equal.

3.4 FIELD QUALITY CONTROL

- A. Section 01 73 00 - Execution: Requirements for testing, adjusting, and balancing.
- B. Testing: Test each valve for leak tightness at 75 percent of set point according to API 2000.
- C. After installation, inspect for interferences and proper supports.
- D. Repair damaged coatings with material equal to original coating.

3.5 CLEANING

- A. Section 01 77 00 - Closeout Procedures: Requirements for final cleaning.
- B. Keep interior of valves clean as installation progresses.

3.6 DEMONSTRATION

- A. Section 01 79 00 – Demonstration and Training: Requirements for demonstration and training.
- B. Demonstrate equipment startup, shutdown, routine maintenance, and emergency repair procedures to Owner's personnel.

3.7 VALVE SCHEDULE

- A. Pressure Relief Valve Schedule:
 - 1. PRV-1 thru 12:
 - a. Application: North Clear Well.
 - b. Type: Hydrostatic.
 - c. Size: 4 inches.
 - 2. PRV-13 thru 24:
 - a. Application: South Clear Well.
 - b. Type: Hydrostatic.
 - c. Size: 4 inches.

END OF SECTION 40 05 67.39

SECTION 40 75 43 - DISSOLVED OXYGEN ANALYZERS

PART 1 - GENERAL

1.1 RELATED DOCUMENTS

- A. Drawings and general provisions of the Contract, including General Conditions, Supplementary Conditions (if included), and Division 1 Specifications Sections, apply to this Section.

1.2 SECTION INCLUDES

- A. Dissolved oxygen meters and mounting hardware.
- B. Dissolver oxygen controller.

1.3 SUBMITTALS

- A. Shop Drawings: Submit in accordance with Section 01 33 00, Submittals Drawings covering the items included under this Section.

1.4 SPARE PARTS

- A. Provide two spare sensors.
- B. Provide one spare sensor arm mounting brackets.

PART 2 - PRODUCTS

2.1 DISSOLVED OXYGEN METERS

- A. Manufacturers: Hach Intellical LDO101, or Engineer approved.
- B. Description: Digital, luminescent/optical dissolved oxygen (LDO) probe, cable and protective shroud for measuring dissolved oxygen in all type of external environment such as river, surface and ground waters, ponds, lakes, sea, wastewater plant, source water, drinking water reservoir for water quality, environmental and treatment process purposes.
- C. Probe Cable: 10 meters.
- D. Probe shall be fitted with an automatic pressure sensor module and a temperature sensor.
- E. DO sensing cap shall be provided with an iButton to track days in use and remind remaining life of the sensing cap element.
- F. Oxygen Probe
 1. Probe Model: Intellical LDO101.
 2. Parameter: Dissolved Oxygen.
 3. Probe Type: Rugged for field use.
 4. Measuring Range: 0.05 – 20.0 mg/l.
 5. Resolution: 0.01/0.1 (5 digits maximum).
 6. Sensor material: Polycarbonate / ABS / Stainless Steel.
 7. Sensor Type: Lumiphore.

8. Output: 4-20 mA current signal proportional to the dissolved oxygen level; source from external 24 VDC power supply.
9. Accuracy: ± 0.2 mg/l for greater than 8 mg/l.
10. Power Requirements: 24 VDC from signal converter.
11. Provide for each installation location.
12. Provide pole mount kit.

2.2 CONTROLLER

- A. Controller Model 902000-SC200.
 1. AC powered: 100 to 240 Vac $\pm 10\%$, 50/60 Hz; 37 W with 25 W sensor/network card load.
 2. The controller uses a menu-driven operation system.
 3. The controller display is graphic dot matrix LCD with LED backlighting.
 4. The controller is equipped with a real-time clock.
 5. The controller is equipped with two security levels.
 6. The controller is equipped with a data logger with RS-232 capability.
 7. The controller shall have worded operation menus in 19 languages.
 8. The controller is equipped with an SD card reader for data download and controller software upload.
 9. Two analog 0/4-20 mA outputs are provided with a maximum impedance of 500 ohms.
 - a. The controller can be equipped with three additional 4-20 mA outputs with a maximum impedance of 500 ohms.
 10. The controller can be equipped with the following forms of communication:
 - a. Profibus DP
- B. Equipment
 1. Materials
 - a. Housing, polycarbonate, aluminum (powder coated), and stainless steel.
 - b. Rating: NEMA 4X enclosure, rated IP66
 2. Conduit openings: 0.5-inch NPT
- C. Accessories: Provide one each of the following for each monitoring system installation:
 1. Stainless steel mounting brackets as required to secure devices as noted on drawings. Controller shall be located on Unistrut affixed to existing tertiary filter building façade.
 2. Weather and sun shield with UV Protection Screen.
 3. Additional mA input card
 4. Additional mA output card

PART 3 - EXECUTION

3.1 PREPARATION

- A. Verify piping arrangement prior to installation.

3.2 INSTALLATION

- A. Install all equipment in accordance with manufacturer's instructions.
- B. Provide adequate piping length for mounting of dissolved oxygen sensors off handrail. Install sensors for access and servicing.

3.3 FIELD QUALITY CONTROL

- A. Installation Check: The manufacturer shall provide the services of a factory-trained representative to check the installation of all equipment installed in this Section. The services shall be as noted in Section 01 60 0.
 - 1. Satisfactorily calibrate each analyzer and instruct the plant personnel in the operation and maintenance of each analyzer.

END OF SECTION

SECTION 46 51 46 - MEMBRANE DIFFUSERS

PART 1 - GENERAL

1.1 SUMMARY

- A. Section Includes: Furnishing and installing an EPDM rubber membrane fine pore aeration system including membrane diffusers, air piping and supports, plus fittings and appurtenance as specified and required for a complete and operating system.

1.2 REFERENCE STANDARDS

- A. American Society of Civil Engineers:
 - 1. ASCE 2 - Measurement of Oxygen Transfer in Clean Water.

1.3 SYSTEM DESCRIPTION

- A. Fine bubble aeration system consists of either disc membrane diffusers or tube membrane diffusers, drop leg piping, manifold piping, lateral piping, pipe supports, purge system (with disc diffusers), diffuser pressure monitoring system, and appurtenances.
- B. CONTRACTOR may select either disc diffusers or tube diffusers.

1.4 PERFORMANCE AND DESIGN REQUIREMENTS

- A. Physical Requirements:
 - 1. Number of Tanks: 2.
 - 2. Passes Per Tank: 1.
 - 3. Grids Per Tank: 1.
 - 4. Tank Dimensions:
 - a. Length: Irregular shape. See Drawings.
 - b. Width: Irregular shape. See Drawings.
 - c. Water Depth: Varies from 10-feet to 11-feet.
 - 5. Initial Flow: 16 MGD
 - 6. Design Flow: 30 MGD
 - 7. Peak Flow: 50 MGD
 - 8. Ultimate Flow: 70 MGD
- B. Oxygen Requirements:
 - 1. Influent Dissolved Oxygen Concentration 3.5 mg/l
 - 2. Effluent Dissolved Oxygen Requirement 6.5 mg/l
- C. Design Requirements:
 - 1. Wastewater Temperature: 10 degrees C to 22 degrees C.
 - 2. Elevation Above Sea Level: 740.
 - 3. Design BOD Loading: Not Applicable
 - 4. Design NH₃ Loading: Not applicable
 - 5. Diffuser Submergence: Varies with flow rate. See SWD above.
 - 6. Design Factors:
 - a. Alpha: 0.90.
 - b. Beta: 0.99.
 - c. Theta: 1.024.
 - 7. Oxygen Demand: As Required to achieve stipulated effluent DO.
 - 8. SOTE Required (Clean Water): As Required to achieve stipulated effluent DO.

- 9. Maximum Pressure Required by Diffusers at Top of Drop Leg Including Submergence and Aeration System Losses: 6.4 psig.
- 10. Maximum Total Air Rate:
 - a. Peak: 800 scfm.

D. Number of Diffusers (minimum per tank @ 50 MGD Peak Design):

	EDI	Aquarius	Sanitaire
Number of Diffusers (minimum)	56	120	150
Number of Diffusers per Clearwell (min)	28	60	75
SOR, pounds/hr.	55.0	55.0	55.0
Minimum SOTE, %	18.3	18.3	18.3
Minimum kla20, 1/hr.	5.5	5.5	5.5

1.5 SUBMITTALS

- A. Include the Following:
 - 1. Drawing showing plan, elevation, and appropriate cross sections of the aeration equipment and anchor location.
 - 2. Complete headloss calculations for the aeration equipment from the manufacturer's point of responsibility. Headloss calculations shall be derived using air at standard conditions and at a design maximum air flow rate per diffuser.
- B. Section 01 33 00 - Submittal Procedures: Requirements for submittals.
- C. Product Data: Submit manufacturer's information for system materials and component equipment.
- D. Shop Drawings:
 - 1. Indicate system materials and component equipment.
 - 2. Indicate connections and other installation details.
- E. Manufacturer's Certificate: Certify that products meet or exceed specified requirements.
- F. Manufacturer Instructions: Submit detailed instructions on installation requirements, including storage and handling procedures.
- G. Field Quality-Control Submittals: Indicate results of Contractor-furnished tests and inspections.
- H. Manufacturer Reports: Certify that equipment has been installed according to manufacturer instructions.

1.6 CLOSEOUT SUBMITTALS

- A. Section 01 77 00 - Closeout Procedures: Requirements for submittals.
- B. Project Record Documents: Record actual locations of diffusers.

1.7 QUALIFICATIONS

- A. The manufacturer to have 5 years' experience in the design, manufacturing, supplying and commissioning of fine bubble aeration equipment of the type specified for this Project. The

equipment shall be of a proven design with at least three installations of similar size, having each been in successful operation for a period of not less than 5 years.

- B. All equipment specified herein shall be supplied by one manufacturer who will be responsible for the entire aeration system.

1.8 DELIVERY, STORAGE, AND HANDLING

- A. Section 01 60 00 - Product Requirements: Requirements for transporting, handling, storing, and protecting products.
- B. Inspection: Accept materials on Site in manufacturer's original packaging and inspect for damage.
- C. Store products according to manufacturer instructions.
- D. Protection:
 - 1. Protect materials from moisture and dust by storing in clean, dry location remote from construction operations areas.
 - 2. Provide additional protection according to manufacturer instructions.

1.9 EXISTING CONDITIONS

- A. Field Measurements:
 - 1. Verify field measurements prior to fabrication.
 - 2. Indicate field measurements on Shop Drawings.

1.10 WARRANTY

- A. Section 01 70 00 - Execution and Closeout Requirements: Requirements for warranties.

1.11 SPARE PARTS

- A. Provide the following for disc type diffuser system:
 - 1. Diffuser Membrane and Holders: 10% of total quantity provided.
 - 2. Holder Retaining Device: 5.
 - 3. Spanner Wrench: 2.
 - 4. Guide or Anchor Supports: 2 of each type provided.
 - 5. Holder Orifice Plugs: 20.
- B. Provide the following for tube type diffusers:
 - 1. Spare Membrane Sleeves and Clamps: 4.
 - 2. FlexAir MiniPanel diffuser assemblies: 2.
 - 3. Diffuser Mounting Saddles and O-Rings: 2.
 - 4. Pipe Supports: 2.
 - 5. End Caps: 2.

PART 2 - PRODUCTS

2.1 MANUFACTURERS

- A. Flexible Membrane Disc Type Diffusers:
 - 1. Aquarius Technologies
 - 2. Sanitaire

3. Substitutions: Not permitted.

B. Flexible Membrane Tube Type Diffusers:

1. Environmental Dynamics, Inc. (EDI) – FlexAir MiniPanel
2. Substitutions: Not permitted

2.2 FLEXIBLE MEMBRANE DISC TYPE DIFFUSERS

A. Disc Membrane Diffusers

1. Membrane

- a. EPDM elastomer, resistant to attack by common municipal wastewater and complying with ASTM D573.
- b. Material to be 55 durometer Shore A, with a minimum tensile strength of 1,375 psi and a minimum elongation of 500 percent at break.
- c. Membrane to be disc-shaped with a 9-inch nominal diameter and an integral O-ring seal molded into the perimeter of the membrane.
- d. The membrane is to be perforated with uniform slits of a shape and size to prevent tearing or lengthening during operation.
- e. Membrane to provide a uniform distribution of air release across the entire surface area of the diffuser, except for the center 1 inch which will not be perforated.
- f. The non-perforated area will provide the necessary sealing capabilities and backflow prevention when air supply is interrupted.

2. Retainer Ring

- a. Constructed of PVC with a minimum of 2 percent of titanium dioxide added for ultraviolet protection.
- b. Provide rings with a minimum of 2-1/2 complete buttress-type threads for maximum holding strength and effective sealing.

3. Membrane Holder

- a. Constructed of PVC with a minimum of 2 percent of titanium dioxide added for ultraviolet protection.
- b. Provide membrane holder with a factory-drilled air flow orifice sized for minimum headloss and uniform air distribution.
- c. Provide holder with a minimum of 2-1/2 threads.
- d. Factory-solvent weld holder to laterals.
- e. Angular variation of all holders not to exceed +1.0 degree.

4. Plugs

- a. Provide polypropylene tapered plugs for holders that will not be provided with diffusers.

B. Drop Leg Piping

1. Upper Piping: Upper drop leg piping will be provided by others. Piping provided will be Type 304L 10S stainless steel conforming to ASTM A778.
2. Upper and Lower Piping Coupling: Provide a stainless-steel clamp adapter to connect the drop leg piping.
3. Lower Piping: From connection with upper piping to the connection with manifold. Piping to be Schedule 40 PVC complying with ASTM D1784 and D1785 or SDR 33.5. Fittings to be socket type Schedule 40 complying with ASTM D1784 and D2466. Pipe and fittings to contain 2 percent titanium dioxide for ultraviolet protection. The lower drop piping will terminate at maximum height not to exceed 5'-0" above the finished floor slab of the clearwells (Elevation 729.00).

C. Manifold Piping: Convey air from drop leg to lateral piping. Piping to be Schedule 40 PVC complying with ASTM D1784 and D1785 or SDR 33.5. Fittings to be socket type Schedule 40 complying with ASTM D1784 and D2466. Pipe and fittings to contain 2 percent titanium dioxide for ultraviolet protection. Provide factory-solvent welded saddle type fittings for connection to lateral piping.

- D. Lateral Piping: Constructed of PVC piping complying with ASTM D3915 and D3034 and SDR of 33.5. Pipe to contain 2 percent titanium dioxide for ultraviolet protection.
- E. Join PVC piping by factory solvent welding in maximum permissible lengths. Field solvent welding will not be permitted. Join PVC piping in the field with positive locking flanged or threaded union type connections.
- F. Pipe Supports: Provide fixed type supports for manifold piping and fixed and guide type supports for lateral piping. Supports to allow 2 inches of vertical adjustment for manifold piping, and 1-1/2 inches of vertical adjustment for lateral piping. Design supports to allow for complete removal from tank (less anchor bolt) to facilitate cleaning and maintenance of tank bottom. Lateral pipe supports to allow longitudinal movement of piping to prevent stress build-up due to thermal expansion or contraction forces. Fabricate pipe supports from Type 304 stainless steel. Provide Type 316 stainless steel expansion anchors to secure pipe supports to tank floor.
- G. Purge System: Consist of PVC drain line, sump, eductor tubing, and tubing carrier pipe. Design system to drain entire submerged aeration piping system for each aeration grid. Construct each aeration grid with an integral drain line terminating at the sump. Sump bottom elevation to be lower than invert of lateral piping and drain line.

2.3 FLEXIBLE MEMBRANE TUBE TYPE DIFFUSERS

- A. Diffusers Membranes
 - 1. Membrane material for the diffuser unit shall be EPDM rubber.
 - a. Alternate membrane materials are not acceptable.
 - 2. Membrane shall be extruded in a single piece with the following characteristics.
 - a. Membrane shall be 117 mm inside diameter with an overall length of 1359 mm.
 - b. Perforated length on diffuser membrane shall be 1308 mm.
 - c. Membrane shall be perforated on the top half of the sleeve.
 - d. Non-perforated membrane section shall be provided to seal off air distribution orifices on the diffuser support structure.
- B. Membrane Support Frame
 - 1. Diffuser assemblies shall be completely factory assembled with diffuser units, membranes and mounting saddle factory installed.
 - a. Field solvent welding or assembly of diffuser is not acceptable.
 - 2. Diffuser assemblies shall be shipped to the jobsite assembled and properly crated and protected for shipment and handling.
 - 3. Diffuser saddle mount shall be ABS or PVC construction and shall be capable of withstanding an external force of 7,500 inch-pounds without structural failure of the air distribution pipe, diffuser unit connection or mounting saddle.
 - a. Small diameter threaded connections to attach diffusers to the air distribution header are not acceptable.
 - b. Saddle mount shall fully encompass the air distribution header and reinforce the pipe section at the diffuser assembly connection.
 - c. Alignment plug shall be provided to ensure proper alignment and resistance to rotation.
 - d. An O-ring gasket shall be provided to ensure an airtight seal between the mounting saddle and air header.
 - 4. A minimum 3.5-inch diameter connection shall be provided between the saddle mount and diffuser assembly.
- C. Mounting Assembly
 - 1. Constructed of ABS capable of withstanding an external force of 4,800-inch pounds without structural failure of the lateral pipe, diffuser connection, or diffuser.
 - 2. Saddle-mount design to fully encompass lateral pipe with O-ring gasket to provide air-tight seal between saddle and pipe connection.

- D. Drop Leg Piping
 - 1. Upper Piping: Upper drop leg piping will be provided by others. Piping provided will be Type 304L 10S stainless steel conforming to ASTM A778.
 - 2. Upper and Lower Piping Coupling: Provide a stainless-steel clamp adapter to connect the drop leg piping.
 - 3. Lower Piping: Schedule 40 PVC complying with ASTM D1784 and D1785. The lower drop piping will terminate at maximum height not to exceed 5'-0" above the finished floor slab of the clearwells (Elevation 729.00).
- E. Manifold and Lateral Piping: Schedule 40 PVC complying with ASTM D1784 and D1785.
- F. Pipe supports shall be all stainless-steel construction.
 - 1. Supports shall accommodate longitudinal movement in the piping components due to the thermal expansion and contraction over a temperature range of 100°F.
 - 2. Supports shall restrain the axial and rotational movement of the pipe while providing for unrestrained longitudinal movement.
 - 3. Supports shall allow leveling of the air piping with 2-inch minimum vertical adjustment at each support.
 - 4. Each pipe support shall be connected to basin floor by at least 2 anchor bolts.
 - 5. The integrated pipe support assembly shall be designed to withstand the associated uplift force of the piping and diffuser assemblies with a minimum design factor of safety equal to ten (10).

2.4 DIFFUSER PRESSURE MONITORING SYSTEM

- A. Monitoring equipment to measure the dynamic wet pressure and operating air flow rate of typical diffuser in each aeration grid. A complete system consisting of panels, tubing, carrier column and ancillary equipment required for a complete monitoring system.
- B. One portable monitoring panel in fiberglass enclosure (NEMA 4X) with stainless steel bracket for temporarily mounting on Unistrut support when used. Portable monitoring panel shall be equipped with differential pressure gages (orifice and diffuser), PVC ball valves, quick coupling connectors, and one set calibration curves.
- C. One fiberglass pressure monitoring panel (NEMA 4X) and carrier column assembly shall be provided for each of the clear wells. Monitoring boxes will be installed on an Unistrut support (sized for both permanent and portable panels) mounted on the existing concrete wall as shown on the Drawings. Monitoring box shall monitor air distributor header pressure, flow control orifice differential pressure, and diffuser element operating differential pressure (DWP).

PART 3 - EXECUTION

3.1 EXAMINATION

- A. Section 01 73 00 - Execution: Requirements for installation examination.
- B. Verify that items provided by other Sections of Work are ready to receive Work of this Section.

3.2 INSTALLATION

- A. According to manufacturer instructions.

3.3 ERECTION

- A. Equipment furnished and installed under this Section shall be fabricated, assembled, erected, and placed in proper operating condition in full conformity with detail drawing, specifications, engineering data, instruction, and recommendations of equipment manufacturer.
- B. Prior to start-up, the manufacturer shall certify in writing that the completed installation is in accordance with its recommendations. Manufacturer's technical representative shall supervise the installation.
- C. The anchor bolts shall be installed under Section 03 15 00 of the Work in accordance with certified prints furnished by manufacturer. An independent testing firm shall verify the anchor bolts are installed in accordance with the manufacturer's recommendations.

3.4 FIELD QUALITY CONTROL

- A. Section 01 79 00 – Demonstration and Training: Requirements for testing, adjusting, and balancing.
- B. Testing:
 - 1. Level the entire diffuser grid within total tolerance of ½-inch.
 - 2. Test for proper operation.
 - 3. Energize system equipment and test operation under supervision of manufacturer's representative and in presence of Engineer.
- C. Manufacturer Services: Furnish services of manufacturer's representative experienced in installation of products furnished under this Section for not less than two days on Site for installation, inspection, startup, field testing, and instructing Owner's personnel in operation and maintenance of equipment.
 - 1. One prior to the installation of the first grid of diffusers to provide instruction for installation and leveling.
 - 2. One to observe leveling and start-up of the first clear well grid and instruct Owner's personnel in system operation and maintenance.
 - 3. One to observe leveling and start-up of the second clear well grid and instruct Owner's personnel in system operation and maintenance.
 - 4. Manufacturer's local representative to be made available on-site for additional assistance as requested by Engineer.
- D. Equipment Acceptance:
 - 1. Anchor pull test by independent testing firm.
 - 2. Adjust, repair, modify, or replace components failing to perform as specified and rerun tests.
 - 3. Make final adjustments to equipment under direction of manufacturer's representative.
- E. Furnish installation certificate from equipment manufacturer's representative attesting that equipment has been properly installed and is ready for startup and testing.

3.5 DEMONSTRATION

- A. Section 01 79 00 – Demonstration and Training: Requirements for demonstration and training.
- B. Demonstrate equipment startup, shutdown, routine maintenance, and emergency repair procedures to Owner's personnel.

3.6 PROTECTION

- A. Section 01 73 00 - Execution: Requirements for protecting finished Work.
- B. Protect membranes from traffic or falling objects until placed into service.

END OF SECTION 46 51 46

APPENDIX A

GEOTECHNICAL REPORT

**Ann Arbor Wastewater Treatment Plant
Tertiary Filter Building
Clear Well Dewatering Analysis**

Prepared by FK Engineering Associates
January 12, 2021



**Ann Arbor Wastewater Treatment Plant
Tertiary Filter Building
Clear Well Dewatering Analysis**
Client Project Number: 0028-20-0010

FKE Project No. 20-191

Prepared for:

OHM Advisors

January 12, 2021

Prepared by:

FK Engineering Associates



TABLE OF CONTENTS

**Ann Arbor Wastewater Treatment Plant
Tertiary Filter Building
Clear Well Dewatering Analysis
Client Project Number: 0028-20-0010**

1 INTRODUCTION..... 1

2 PROJECT BACKGROUND AND EXISTING INFORMATION..... 1

2.2 Existing Site Information..... 2

3 GEOTECHNICAL INVESTIGATION..... 3

3.1 Test borings..... 3

3.2 Groundwater Monitoring Wells 4

4 DATA PRESENTATION..... 5

5 SUBSURFACE CONDITIONS 5

5.1 Soil Conditions..... 6

5.2 Groundwater Conditions 6

5.3 Monitoring Wells and Slug Testing 7

6 EVALUATIONS AND RECOMMENDATIONS..... 8

6.1 Soil and Aquifer Conditions 8

6.2 Groundwater Conditions & Hydrostatic Uplift 9

6.3 Pressure Relief Valve Construction Recommendations 10

7 LIMITATIONS 11

Ms. Jennifer Drinan, P.E.
OHM Advisors, Inc.
34000 Plymouth Road
Livonia, MI 48150

RE: Report on The Ann Arbor Wastewater Treatment Plant
Clear Well Dewatering Analysis
Ann Arbor, Michigan

Dear Ms. Drinan,

The following sections provide our report on our analysis of the proposed Tertiary Filter Building (TFB) Clear Well dewatering operation that we understand is currently planned as part of upcoming modifications and upgrades to this section of the Ann Arbor Wastewater Treatment Plant.

1 INTRODUCTION

In accordance with our December 9, 2020 proposal, FK Engineering Associates (FKE) has prepared this Interpretative Geotechnical Investigation Report for the proposed dewatering and improvements of the Clear Wells in the Tertiary Filter Building located in the Ann Arbor Wastewater Treatment Plant in Ann Arbor, Michigan. This report presents project background information, applicable historical information, our field investigation activities, subsurface conditions observed, and our corresponding evaluations and recommendations with respect to the proposed Clear Well Improvements.

2 PROJECT BACKGROUND AND EXISTING INFORMATION

A summary of the project background and available existing subsurface soil and groundwater information sources used in this report are summarized in the following sections.

2.1 Project Background

Retained by the City of Ann Arbor, OHM Advisors (OHM) is currently developing plans for improvements to the Tertiary Filter Building (TFB) at the Ann Arbor Wastewater treatment plant located at 49 S. Dixboro Road in Ann Arbor, Michigan. At the TFB, the partially treated wastewater flows through sand filter media and is stored in clear wells prior to exiting the TFB and entering the Ultra Violet Light Disinfectant facility.

Per the drawing set provided by OHM to formulate our December 9, 2020 proposal titled, “City of Ann Arbor WWTP Clear Well Improvements” dated December 4, 2020, the TFB invert is

comprised of a 1'-4" thick concrete slab at Elevation 724 (top of slab). The ground surface in the area ranges about 743 to 738. The bottom of the base slab is approximately 15 feet below ground surface. Publicly available topographic information (Google Earth) indicates that the water level of the adjacent Huron River was elevation 731 in March 2020.

The proposed TFB improvements will require dewatering the TFB and replacing pressure relief valves that were designed and installed in the slab to relieve excess groundwater pressure from below the slab.

Since the construction of the TFB, the clear wells have been in near continuous use and have only been dewatered for short periods of time. During these dewatered events, it was observed that pressure relief valves located within the base slab that allow groundwater to drain up through the base slab into the clear wells, were not flowing and may not be functioning. As such, there is concern that uplift force from groundwater acting on the foundation slab of TFB when the clear wells are dewatered for repairs, may damage the foundation slab.



Figure 1: Project Location

FKE has been retained by OHM to determine the current subsurface soil and groundwater characteristics around the TFB, determine the hydrostatic uplift forces acting on the bottom of the TFB, and provide corresponding evaluations and recommendations regarding the proposed clear well improvements with respect to the pressure relief valve replacements that will be implemented during construction.

2.2 Existing Site Information

Numerous subsurface soil and groundwater investigations and evaluations have been undertaken at the Ann Arbor Wastewater Treatment Plant (AAWWTP). We have reviewed the available information provided by OHM, and it appears that the following two documents are relevant in the context of our investigation and analysis:

- Geotechnical Hydrogeological Investigation
Ann Arbor Wastewater Treatment Plant Upgrades
Prepared by NTH Consultants -- November 23, 2010
- Aquifer Pumping Test Evaluation
Ann Arbor Wastewater Treatment Plant
Prepared by NTH Consultants -- November 23, 2010

Both reports include information regarding the subsurface soil and groundwater conditions found in the entire AAWWTP site. Subsurface soil information near the TFB was explored by the historic borings TB-307A, TB-506, and TB-606. In general, these reports indicate the presence of an unconfined, and deeper confined aquifer at the TFB site. The groundwater within the confined aquifer is in the artesian (pressurized) condition and was observed to have a static water level of approximately 18 to 23 feet above ground surface during investigation leading up to the 2010 reports. The pump test evaluation concluded that the upper (partially) unconfined and lower confined aquifers are not hydraulically connected. The adjacent Huron River was identified as a likely discharge feature for the upper unconfined aquifer. Information from these reports is summarized in greater detail in Section 5 of this report.

3 GEOTECHNICAL INVESTIGATION

Fieldwork for the geotechnical investigation was performed on December 18, 19, & 21, 2020. Prior to beginning the geotechnical investigation, clearances for underground utilities were obtained using the Michigan one-call utility locating center (MISS DIG). Coordination with representatives from OHM and the City of Ann Arbor was also completed prior to and during drilling operations.

3.1 Test borings

The geotechnical investigation consisted of drilling two test borings designated as TB-1 and TB-2. TB-1 was drilled on the north side of the TFB and was advanced to 40 feet deep. It should be noted that TB-1 was not advanced to the originally planned depth of 45 feet due to auger refusal. TB-2 was drilled on the south side of the TFB and was advanced to 45 feet deep. The approximate location of the test borings is indicated on Figure 1 of Appendix A.

The test borings were drilled by our subcontractor, under observation from an FKE engineer, and were advanced using a CME 75 truck-mounted drilling rig using continuous flight hollow stem augers to the termination depth. 4¼-inch inside diameter augers were used for TB-1 and 2¼-inch inside diameter augers were used for TB-2. Upon completion of drilling, monitoring wells designated as MW-1 and MW-2 were installed in TB-1 and TB-2, respectively.

TB-1 and TB-2 were sampled using the Standard Penetration Test (SPT) method (ASTM D-1586) at 2½-foot intervals for the upper 10 feet, and then at 5-foot intervals to the explored depth. The SPT method consists of driving a 2-inch outside diameter split-barrel sampler into the soil with a 140-pound weight falling freely for 30 inches. The sampler is generally driven three successive 6-inch increments, with the number of blows for each increment being recorded. The number of blows required to advance the sampler the second and third 6-inch increments is termed the Standard Penetration Resistance (N) and is presented on the Logs of Test Boring. As

added information, the blow counts for each 6-inch increment are also presented on the Logs of Test Boring.

All soil samples obtained with the split barrel sampler are designated with an “S” on the test boring logs. Recovered samples were sealed in jars and transported to our office for further classification and select laboratory testing. Our engineer also recorded groundwater level observations during and following completion of drilling.

Ground surface elevations are estimated based on local topographic data (Google Earth) in conjunction with offsets from points of known elevation associated with the TFB and the elevation view of the TFB in the provided “City of Ann Arbor WWTP Clear Well Improvements” drawing set dated December 4, 2020. As such, ground surface elevations reported on the logs and elsewhere should be considered approximate. Test boring locations were not surveyed and are also considered approximate.

3.2 Groundwater Monitoring Wells

Monitoring wells were installed in the test borings upon completion of drilling on December 18 and 19, 2020. The monitoring wells were designated as MW-1 and MW-2 and consisted of 2 inch inside diameter PVC casing and screens. MW-1 and MW-2 extend to a depth of 30 feet with a 10-foot slotted PVC screen interval present from 20 to 30 feet deep.

On December 21, 2020, both wells were developed by pumping out the casing and allowing groundwater to clear the well pack and screen. MW-1 was developed by pumping out a single casing volume, as after pumping in MW-1, only limited recharge occurred (approximately 1-foot an hour). MW-2 was developed by pumping several casing volumes of water over approximately 30 minutes, until discharge water turbidity decreased, and the discharge was visibly clear.

MW-1 did not show enough recharge to conduct meaningful slug testing. After the development of MW-2, a series of slug tests were performed to determine the near-well hydraulic conductivity. Groundwater observations and the results of slug testing are discussed later in this report.

4 DATA PRESENTATION

Data presented in the report attachments are organized as follows:

APPENDIX A: Clear Well Dewatering Geotechnical Investigation

- Figure No. 1: Location Plan
- Figure No. 2: FKE Soil Classification System
- Figure Nos. 3 & 4: Logs of Test Borings
- Figure Nos. 5 & 6: Logs of Monitoring Wells
- Figure No. 7: Tabulation of Laboratory Test Data
- Figure Nos. 8-10: Individual Laboratory Test Results
- Figure Nos. 11-22: Slug Test Results
- Figure Nos. 23-24: Jet Filter System Details

APPENDIX B: Relevant Historic Borings

- Figure No. 1: Log of Test Boring TB-307A
- Figure No. 2: Log of Test Boring TB-506
- Figure No. 3: Log of Test Boring TB-606

The FKE Soil Classification System defining the nomenclature used to describe soil conditions on individual boring logs and throughout this report is attached as Figure No. 2 in Appendix A. The stratification shown on the Logs of Test Borings represent the subsurface conditions at the actual boring locations, and are based on behavioral characteristics. Variations may occur between and away from the borings. Additionally, the stratigraphic lines represent the approximate boundary between soil types; however, the transition may be more gradual than what is shown.

We have prepared the logs included with this report based on field classification supplemented with laboratory testing where applicable. Laboratory testing performed includes moisture content, dry density, grain size distributions (sieve analysis), and unconfined compressive strength of cohesive soil samples. In addition to subsoil stratification, the Logs of Test Borings and Monitoring Wells present groundwater observations, drilling and sampling information, and other relevant data.

5 SUBSURFACE CONDITIONS

The generalized subsurface conditions encountered during this investigation as well as the historic 2010 investigations are discussed in the following sections.

5.1 Soil Conditions

Subsurface soil conditions were explored in this investigation by TB-1 and TB-2; and in historic investigations by TB-307A, TB-506, and TB-606. TB-307A was profile drilled to 33.5 feet prior to sampling.

The borings generally indicate the presence of fill soils to depths ranging from about 9 to 15 feet below ground surface. These fill soils are generally comprised of stiff to hard cohesive soils with occasional dark staining and trace organic material. In TB-1, the cohesive fill soil is present to about 13 feet and is immediately underlain by native very hard silty clay to the explored depth of 40 feet. In TB-2, the cohesive fill soil was present to about 9 feet and underlain by native hard silty clay. The native hard silty clay is present to a depth of about 14 feet where very loose to loose granular soil is present to a depth of approximately 21 feet. This is similar to the conditions encountered in the adjacent historic borings, TB-506 and TB-606. In TB-506, loose to medium compact sand was present from about 14 feet to the explored depth of 20 feet. In TB-606, medium compact sand was present from about 17 to 21 feet deep.

Below 21 feet in TB-2 and TB-606, the granular soils are underlain by hard to very hard silty clay to the respective explored depths of about 45 feet and 25 feet, notwithstanding very compact granular layers encountered from about 33.5 to 34 feet and in the last couple inches of TB-2. Similar to TB-1, TB-2, and TB-506, the very hard silty clay layer was also present in TB-307A. In TB-307A, the very hard silty clay is present to a depth of 74 feet. Below 74 feet in TB-307A lays compact gray sand to the explored depth of 76 feet.



Figure 2: TB-2 S-5, granular soil present at about 14 feet deep

5.2 Groundwater Conditions

Subsurface groundwater conditions were explored in this investigation by TB-1 and TB-2; and in historic investigations by TB-307A, TB-506, and TB-606. Monitoring wells MW-1 and MW-2 were installed in TB-1 and TB-2, respectively. These conditions are summarized in the following table.

Table 1: Ground water Observations					
Test Boring	During Drilling (ft-bgs)	After Drilling (ft-bgs)	Groundwater in Monitoring Well Pre-development (ft-bgs)	Groundwater in Monitoring Well Post-development (ft-bgs)	Depth of aquifer producing Artesian flow (ft-bgs)
TB-1	13.5 (El 724.5)	15 (El 723)	3.5 (El 734.5)	26.7 (El 711.3)	N/A
TB-2	18.5 (El 724.5)	13 (El 730)	12.9 (El 730.1)	12.8 (El 730.2)	N/A
TB-307A	N/A ²	Above ground surface ³	N/A	N/A	74 ⁴ (El 664)
TB-506	14.5 (El 727)	11.6 (El 729.9)	N/A	N/A	N/A
TB-606	15 (El 727)	16 (El 726)	N/A	N/A	N/A

1) N/A – Not Applicable

2) Wash rotary drilling techniques prevented groundwater level observations during drilling

3) Artesian groundwater level at elevation 761.2 in stacked casing after drilling (~23 feet above ground surface)

4) Approximate artesian groundwater flow at ground surface = 350 gallons per minute.

The groundwater levels during and after drilling, except for the artesian flow in TB-307A, generally correlate with (or are slightly below) the adjacent Huron River water level that is about Elevation 731 during normal flow. A color change from brown to gray was encountered in TB-1, TB-2, TB-506, and TB-606 at depths ranging from about 13 to 17 feet deep (El 722 to El 728). The long-term static groundwater elevation is generally associated with the soil color change depth from brown to gray.

5.3 Monitoring Wells and Slug Testing

For single well recovery testing (herein after referred to as “slug testing”) activities, six slug tests were completed in MW-2. The slug tests were generally performed by introducing or removing a volume displacement apparatus that induced an immediate water level change within the well. This resulting water level recovery within the well was monitored using a pressure transducer set to record at 1.0 second intervals to measure static head, displacement, and recovery data. This information is used to provide an estimate of hydraulic conductivity (k).

The data collected was analyzed using analytical solutions found in the hydraulic software program AQTESOLV (Version 4.5) using the specific well construction parameters. We evaluated the slug test data using the Hvorslev (1951) and the Bouwer and Rice (1976) solutions. Although at TB-2 there appears to be a near surface native silty clay confining layer, this layer is not present at TB-506 and TB-606, and therefore the upper aquifer would likely behave as an unconfined aquifer during groundwater dewatering. As such, our analysis was performed

assuming an unconfined condition. The results indicated an estimated hydraulic conductivity average of 0.00293 centimeters per second (2.9×10^{-3} cm/sec). A summary of the results of the hydraulic conductivity tests are presented in the following table. Full results are included in Figure Nos. 11-22 of Appendix A.

Table 2: MW-2 Slug test Results		
Test Name	Hydraulic Conductivity (cm/s)	
	Bower-Rice Solution	Hvorslev Solution
Slug in 1	0.002357	0.003076
Slug in 2	0.002831	0.003599
Slug in 3	0.002265	0.002908
Slug out 1	0.002636	0.003566
Slug out 2	0.00266	0.003373
Slug out 3	0.002592	0.003263
Average	0.00293	

Slug testing was not conducted in MW-1 because there was limited recharge after pumping water out of MW-1 in an attempt to develop the well.

6 EVALUATIONS AND RECOMMENDATIONS

Based on the subsurface conditions encountered during this investigation and our review of historic investigations at the site, our evaluations and recommendations for the clear well improvements inside the TFB are presented in the following sections.

6.1 Soil and Aquifer Conditions

The hydrogeological subsurface conditions of the site are generally comprised of (in order of depth) an upper fill layer underlain by an apparently discontinuous upper confining layer, further underlain by a discontinuous silty sand aquifer (apparently behaving as an unconfined aquifer), an underlining confining layer, and a lower confined aquifer. The upper unconfined aquifer is comprised of native granular material, with the bottom of this layer (where it is present) at approximately 21 feet deep (elevation ranging from about 721 to 722). The lower confining layer is comprised of very hard gray silty clay (with occasional thin granular layers) present from about 21 feet to approximately 74 feet. The confined aquifer present beneath the confining layer is comprised of compact sand.

The results of the monitoring well development and slug testing indicated that the hydraulic conductivity of the upper granular soils that would apparently extend below the TFB base slab

(top of base slab elevation of about 724) are about 3×10^{-3} cm/sec, which is within the typical expected values for the granular material present in TB-2, TB-506, and TB-606. It should be noted that uniform soil conditions are not present under the TFB as shown in TB-1 which indicated silty clay from about 13 feet to the explored depth of 40 feet. 10^{-6} centimeters per second is the typical upper range value for the type of cohesive soils encountered at the base slab elevation in TB-1.

6.2 Groundwater Conditions & Hydrostatic Uplift

We understand that OHM will be performing structural analysis of the base slab's ability to resist hydrostatic uplift on the basis of the groundwater head acting against the bottom of the TFB base slab, minus the weight of the base slab.

The encountered groundwater level of the unconfined aquifer at the time of the field work for this investigation ranged from about El 725 to 730, with levels as high as about El 729 during the historical investigations. The static groundwater level measured at the time of our investigation was approximately El 730.1, based on measurements of MW-TB-2 on January 8, 2021. MW-TB-1 does not appear to be connected to the upper aquifer and so is not considered. The top of the TFB base slab is at El 724, and the bottom is about El 722.7. Assuming a potential seasonal high groundwater level at El 730, the resultant unconfined aquifer hydrostatic uplift force acting on the bottom of the TFB base slab is as much as about 500 pounds per square foot. Based on the variation between the various borings (historical test borings indicate groundwater as low as Elevation 726), this force may be as low as about 100 psf or lower (possibly approaching zero) during seasonal low groundwater levels.

Although, as noted in Section 6.1, the hydraulic conductivity of some of the soils below the TFB base slab appear to be relatively low, the point where the concrete foundation and the bearing soils meet is not considered watertight, therefore hydrostatic uplift forces will act uniformly on the base slab despite localized heterogeneity of the soil matrix.

The static groundwater level of the lower confined aquifer during the historic 2010 investigation was at approximate elevation 761, measured within stacked casing above the ground surface. The confining layer between the confined and unconfined aquifers is of sufficient thickness and density that there is not expected to be hydrostatic uplift pressure from the confined aquifer acting on the bottom of the TFB base slab.

Groundwater levels fluctuate with seasonal variations and during periods of heavy or prolonged precipitation events. As such, appropriate safety/strength reduction factors should be applied when considering the capacity of the TFB base slab to resist hydrostatic uplift forces.

6.3 Pressure Relief Valve Construction Recommendations

Per the drawing set provided by OHM titled “City of Ann Arbor WWTP Clear Well Improvements” dated December 4, 2020, there are 24 existing pressure relief valves (PRV) located in the TFB base slab. Upon temporary dewatering and inspection of the Clear Well by others, the existing PRVs were found to be apparently nonfunctional, as no water was apparently seeping from them during the inspection. However, it should be noted that it is possible that the inspections were conducted during a low groundwater period (near or below Elevation 724) and were not flowing for that reason.

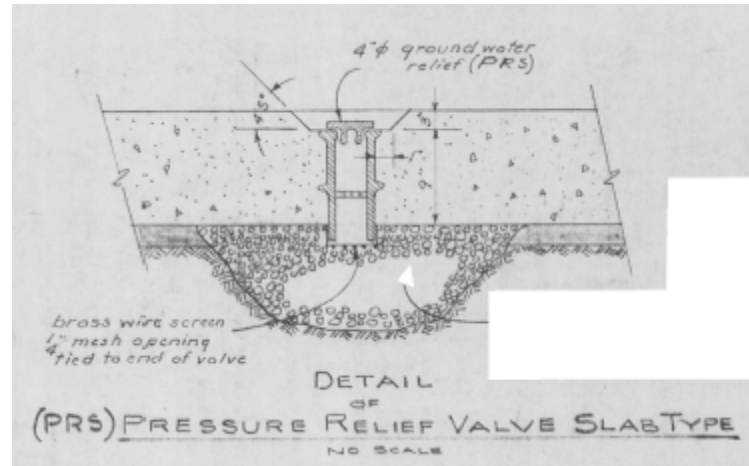

Figure 3: Existing Pressure Relief Valve Detail

In any case, the drawing set indicates that these PRVs are scheduled to be replaced by saw cutting a 2-foot square around the existing PRV and undercutting the underlying soil and replacing with new drainage gravel to 12 inches deep, then installing horizontal dowel bars and new PRVs and replacing the concrete flush with existing. This is a valid approach, although we recommend using hydrophilic waterstop around the cut concrete perimeter. Alternatively, the existing PRVs could be over cored with a concrete core barrel, the soil immediately beneath the core could be removed and replaced with drainage gravel and a new PRV installed in the core hole and sealed and anchored into the slab from above.

Regardless to whether coring or saw cutting is used to remove the existing PRVs, the use of a 316 Stainless Steel Closed-End – Check Valve Style Jet Filter should be considered. These valves only allow flow in one direction and are comprised of a filter housing and a removable filter cartridge that can be easily replaced or cleaned. The filter housing is mounted to the concrete slab and the filter cartridge is mounted to the filter housing. A detail of this valve system is shown in Figure Nos. 23 and 24 of Appendix A.

Because the groundwater is apparently always above El 722.7 (the bottom the TFB base slab elevation), at least some groundwater dewatering will be necessary to maintain a stable hole for the placement of the filter pack for the new valves. We suggest that 1 to 4 well point dewatering wells be installed adjacent to each of the proposed cut-openings, to control groundwater and to allow for stable excavation during the valve replacement activities. Such a dewatering system should be sized considering a static head 10 feet above the slab, and assuming a hydraulic conductivity of approximately 3×10^{-3} cm/se. Such a dewatering system could expect to produce

on the order of 3 to 10 gallons per minute per PRV installation once equilibrium conditions have been achieved.

7 LIMITATIONS

The report is intended for specific use during design and construction of the Ann Arbor Wastewater Treatment Plant Tertiary Filter Building Clear Well Improvement project as discussed herein. We have developed recommendations based on the data presented in this report and information provided by OHM to formulate our original proposal. We should be notified of any significant changes as our recommendations may require revision.

It was a pleasure providing geotechnical engineering services to you on this project. Should you have any questions or require additional information, please call.

Sincerely,
FK Engineering Associates



James M. Elsey, P.E.
Assistant Project Engineer



Fritz J. Klingler
President

JME/SAK

Attachments

APPENDIX A: Clear Well Improvements

Clear Well Dewatering Geotechnical Investigation



FK Engineering Associates

Excellence in Infrastructure and Underground Engineering

ANN ARBOR WASTEWATER TREATMENT PLANT

SCALE: 1" = 100'



0 1
1 INCH = 100 FEET

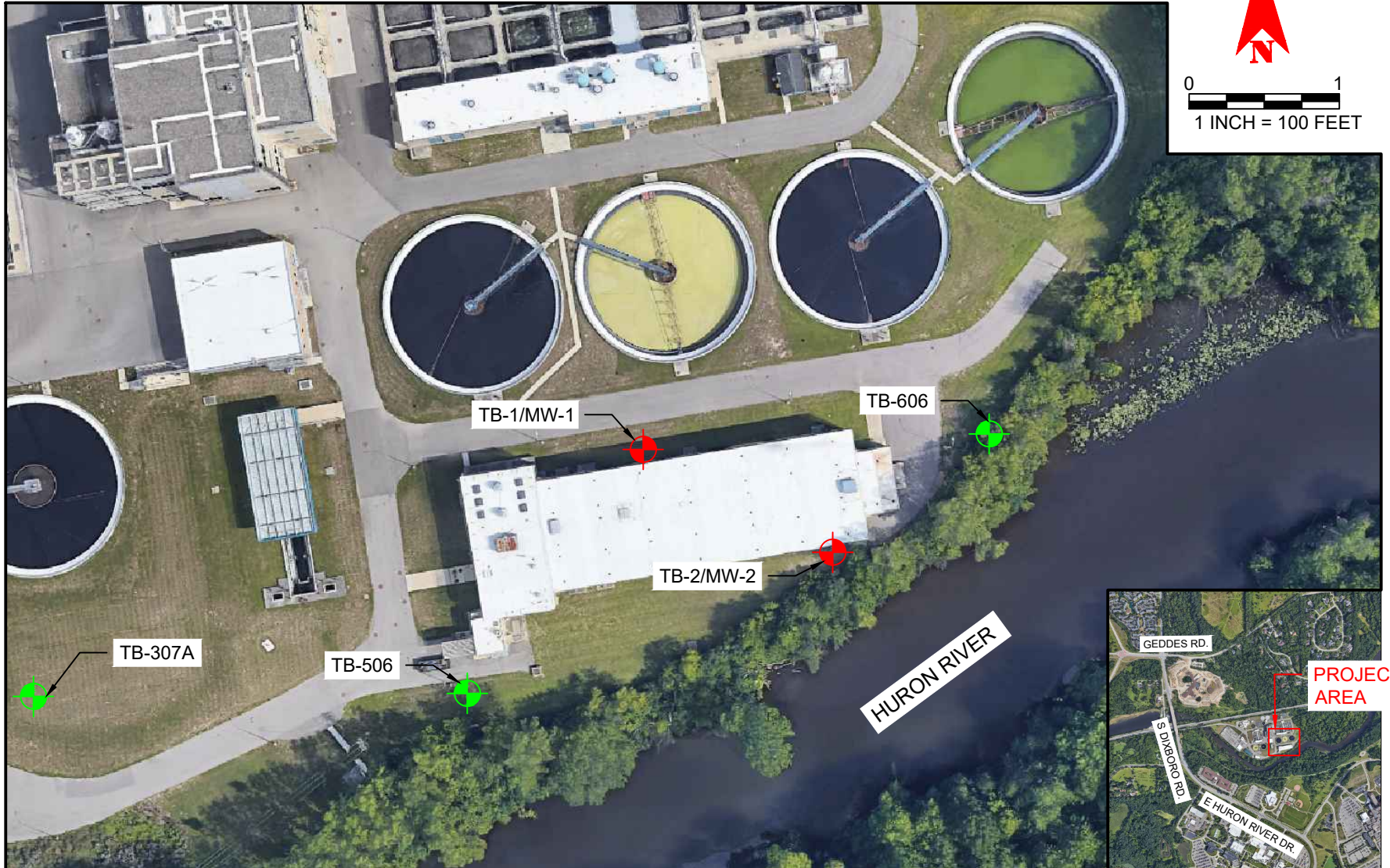

TEST BORINGS/MONITORING WELLS
DRILLED BY SCHMIDT DRILLING CO.
UNDER FULL TIME OBSERVATION BY FKE
ON DECEMBER 18 & 19, 2020.

TEST BORINGS DRILLED BY AMERICAN
DRILLING & TESTING CO. UNDER FULL
TIME OBSERVATION BY NTH PRIOR TO
2010.

FKE PROJECT No.:
20-191
DESIGNED BY:
JME
DRAWN BY:
SAK
CHECKED BY:
JME

CAD FILE NAME:
LP.dwg
PLOT DATE:
4-Jan-21
DRAWING SCALE:
1"=100'
CREATED ON:
23-Dec-20



FKE

248.817.2946
Madison Heights, MI

REV #	DATE	REVISION TITLE
---	---	---
---	---	---
---	---	---
---	---	---

ANN ARBOR
WW TREATMENT PLANT
ANN ARBOR, MI
LOCATION PLAN

FIGURE NO.

1

SOIL CLASSIFICATION SYSTEM

SUMMARY OF SOIL NOMENCLATURE

Soils are to be classified by the fraction which has the greatest impact on the engineering behavior. Soils will be described according to a strength or density followed by color then by primary and secondary/tertiary components (i.e. soft gray silty clay or loose brown silty sand). United Soil Classification System (USCS) descriptors (ASTM D2487) may also be used. Soils which exhibit unconfined shear strength will in most cases be described as cohesive soils regardless of their clay content whereas soils without unconfined strength will be described as cohesionless soils.

COHESIVE SOIL

COHESIONLESS SOIL

Strength	Unconfined Compressive Strength (psf) (Primary)	Pocket Penetrometer Test (tsf) (Primary)	SPT Value (N) (Secondary)	Density	SPT Value (N)
Very Soft	0-500	0-0.25	0-2	Very Loose	<4
Soft	500-1000	0.25-0.5	3-4	Loose	4-10
Medium	1000-2000	0.5-1.0	5-8	Medium Compact	11-30
Stiff	2000-4000	1.0-2.0	9-15	Compact	31-50
Very Stiff	4000-8000	2.0-4.0	16-30	Very Compact	>50
Hard	8000-16000	4.0-8.0	31-50		
Very Hard	>16000	>8.0	>50		

MATERIAL SIZES AND IDENTIFIER GUIDE

Gravel	3/16 inches (No. 4 Sieve) to 3 inches	Generally rounded rock particles
Coarse Sand	3/16 inches to 2 mm (No. 10 Sieve)	Grains easily seen
Medium Sand	2 mm to 0.425 mm (No. 40 Sieve)	Grains can be seen and felt
Fine Sand	0.425 mm to 0.075 mm (No. 200 Sieve)	Grains can be felt
Silt	0.075 mm to 0.005 mm	Easily cracks when rolled. Gritty feel. Dilatant.
Clay	<0.005 mm	Can be rolled. No particle size visible.

SECONDARY/TERTIARY SOIL COMPONENTS

Use secondary components when other than the primary soil appears in significant percentages. Generally the secondary component will compromise between 12 and 30 percent of the total soil weight. Tertiary components would be described as "little" and "trace" when the tertiary components are between 5 and 12 percent and less than 5 percent, respectively. The tertiary components would be inserted after the secondary and primary description (i.e. soft gray silty clay with little gravel and trace sand).

SAMPLE CODES

S	Spilt Spoon Sample	AU	Auger Sample
LS	Split Spoon Sample with Liner	ST	Shelby Tube Sample
BS	Bag Sample	P	Piston Tube Sample

This system is based on the USCS and MDOT's Uniform Field Soil Classification System

LOG OF TEST BORING NO: TB-1

Project Name: *Clear Well Dewatering Analysis*
 Project Location: *Ann Arbor Waste Water Treatment Plant*



FK Engineering Associates
 Project No: 20-191
 Checked By: S. Kucharek

SUBSURFACE PROFILE

SOIL SAMPLE DATA

ELEV. (ft)	PRO-FILE	GROUND SURFACE ELEVATION: 738	DEPTH (ft)	SAMPLE TYPE/NO.	BLOWS / 6 inches	STD. PEN RESIST. (N)	REC (in)	Organic Content (%)	MOIST. CONTENT (%)	DRY DENSITY (pcf)	UNCONF. COMP ST (psf)
735		FILL: Very Stiff to Hard Mottled Dark Brown and Gray SILTY CLAY with Trace Sand, Gravel, Brick Fragments, and Organic Material	3.8	S-1	3 4 4	8	18	-	-	-	8000*
	734.2		5	S-2	1 2 2	4	14	-	-	-	2000*
730		FILL: Medium to Stiff Mottled Brown and Gray SILTY CLAY with Trace Sand, Gravel, and Organic Material (occasional dark staining)		S-3	1 3 11	14	18	-	-	-	-
			10	S-4	1 4 6	10	11	-	-	-	-
725		Very Hard Gray SILTY CLAY with Trace Sand and Gravel	12.5								
	725.5		15	S-5	14 10 12	22	16	-	-	-	>9000*
720											
			20	S-6	23 10 21	21	18	-	-	-	>9000*
715											
			25	S-7	32 44 8/1"	>50	4**	-	-	-	-
710											
			30.0	S-8	15 27 35	62	18	-	-	-	>9000*

Total Depth: 40 FT
Drilling Date: 12/18/2020
Inspector: J. Elsey, PE
Contractor: Schmidt Drilling Co.
Driller: M. Schmidt
Drilling Method:
 Drilled using a CME 75 with 4-1/4 inch HSA to EOB.

Water Level Observation:
 Ground water was encountered at 13.5 ft during drilling and at 15 ft upon completion of drilling.

Notes:
 1) *- Denotes pocket penetrometer value.
 2) ** - Denotes initial recovery was 0" and split spoon was pushed to obtain sample.

Plugging Procedure:
 Monitoring well installed.

Figure No. 3

LOG OF TEST BORING 20-191 LOGS.GPJ 1/4/21

LOG OF TEST BORING NO: TB-1

Project Name: *Clear Well Dewatering Analysis*

Project Location: *Ann Arbor Waste Water Treatment Plant*



FK Engineering Associates

Project No: 20-191

Checked By: S. Kucharek

SUBSURFACE PROFILE				SOIL SAMPLE DATA							
ELEV. (ft)	PRO-FILE	GROUND SURFACE ELEVATION: 738	DEPTH (ft)	SAMPLE TYPE/NO.	BLOWS / 6 inches	STD. PEN RESIST. (N)	REC (in)	Organic Content (%)	MOIST. CONTENT (%)	DRY DENSITY (pcf)	UNCONF. COMP ST (psf)
705	[Hatched Profile]	Very Hard Gray SILTY CLAY with Trace Sand and Gravel	35	S-9	8 26 25/3"	>50	15	-	-	-	>9000*
700			40	S-10	11 22 39	61	18	-	10.6	131.0	27719
698.0			END OF BORING		40.0						
695			45								
690			50								
685			55								
680			60								
675			65								

LOG OF TEST BORING 20-191 LOGS.GPJ 1/4/21

LOG OF TEST BORING NO: TB-2

Project Name: *Clear Well Dewatering Analysis*
 Project Location: *Ann Arbor Waste Water Treatment Plant*



FK Engineering Associates
 Project No: 20-191
 Checked By: S. Kucharek

SUBSURFACE PROFILE

SOIL SAMPLE DATA

ELEV. (ft)	PRO-FILE	GROUND SURFACE ELEVATION: 743	DEPTH (ft)	SAMPLE TYPE/NO.	BLOWS / 6 inches	STD. PEN RESIST. (N)	REC (in)	ORGANIC CONTENT (%)	MOIST. CONTENT (%)	DRY DENSITY (pcf)	UNCONF. COMP ST (psf)
740		FILL: Stiff Brown SANDY CLAY with Trace Silt, Gravel, and Organic Material		S-1	3 3 5	8	15	-	-	-	3000*
		739.0	4.0								
		FILL: Hard Mottled Brown and Gray SILTY CLAY with Trace Sand, Gravel, and Organic Material (occasional dark staining)		S-2	3 4 6	10	18	-	-	-	>9000*
735			5								
				S-3	3 4 4	8	18	-	-	-	-
		734.0	9.0								
		Hard Gray SILTY CLAY with Trace Sand, Gravel, and Organic Material (occasional dark staining)		S-4	4 5 4	9	17	-	-	-	>9000*
730			10								
				S-5	4 4 6	10	18	-	12.2	-	-
		729.0	14.0								
		Loose Brown GRAVELLY SAND with Trace Clay and Silt		S-6	4 1 1	2	1**	-	-	-	-
725			15								
		Very Loose Gray SAND with Trace Gravel		S-7	2 7 11	18	13	-	8.8	138.4	16074***
		727.0	16.0								
				S-8	9 12 15	27	18	-	-	-	>9000*
720			20								
		722.0	21.0								
		Hard Gray SILTY CLAY with Trace Sand and Gravel		S-9	11 18 23	41	18	-	-	-	>9000*
715			25								
		713.0	30.0								

Total Depth: 44.4 FT
Drilling Date: 12/19/20
Inspector: J. Eelsey, PE
Contractor: Schmidt Drilling Co.
Driller: M. Schmidt
Drilling Method:
 Drilled using a CME 75 with 2-1/4 inch HSA to EOB.

Water Level Observation:
 Ground water was encountered at 18.5 ft during drilling and at 13 ft upon completion of drilling.

Plugging Procedure:
 Monitoring well installed.

Notes:
 1) *- Denotes pocket penetrometer value.
 2) ** - Denotes initial recovery was 0" and split spoon was pushed to obtain sample.
 3) *** - Denotes low strain failure rate.

Figure No. 4

LOG OF TEST BORING 20-191 LOGS.GPJ 1/11/21

LOG OF TEST BORING NO: TB-2

Project Name: *Clear Well Dewatering Analysis*

Project Location: *Ann Arbor Waste Water Treatment Plant*



FK Engineering Associates

Project No: 20-191

Checked By: S. Kucharek

SUBSURFACE PROFILE				SOIL SAMPLE DATA							
ELEV. (ft)	PRO-FILE	GROUND SURFACE ELEVATION: 743	DEPTH (ft)	SAMPLE TYPE/NO.	BLOWS / 6 inches	STD. PEN RESIST. (N)	REC (in)	ORGANIC CONTENT (%)	MOIST. CONTENT (%)	DRY DENSITY (pcf)	UNCONF. COMP ST (psf)
710		Hard Gray SILTY CLAY with Trace Sand and Gravel									
		709.5 709.0	33.5 34.0								
		Very Compact Gray SILTY SAND with Trace Clay and Gravel	35	S-10	22 26 33	59	18	-	-	-	>9000*
705		Hard Gray SILTY CLAY with Trace Sand and Gravel									
			40	S-11	17 30 31	61	18	-	-	-	>9000*
700		Hard Gray SILTY CLAY with Trace Sand and Gravel									
		698.8 698.6	44.2 44.4								
		Very Compact Gray SAND	45	S-12	23 50/5"	>50	10	-	-	-	>9000*
		END OF BORING									
695											
			50								
690											
			55								
685											
			60								
680											
			65								

LOG OF TEST BORING 20-191 LOGS.GPJ 1/11/21

Monitoring Well NO: TB-1

Project Name: *Clear Well Dewatering Analysis*

Project Location: *Ann Arbor Waste Water Treatment Plant*



FK Engineering Associates

Project No: 20-191

Checked By: S. Kucharek

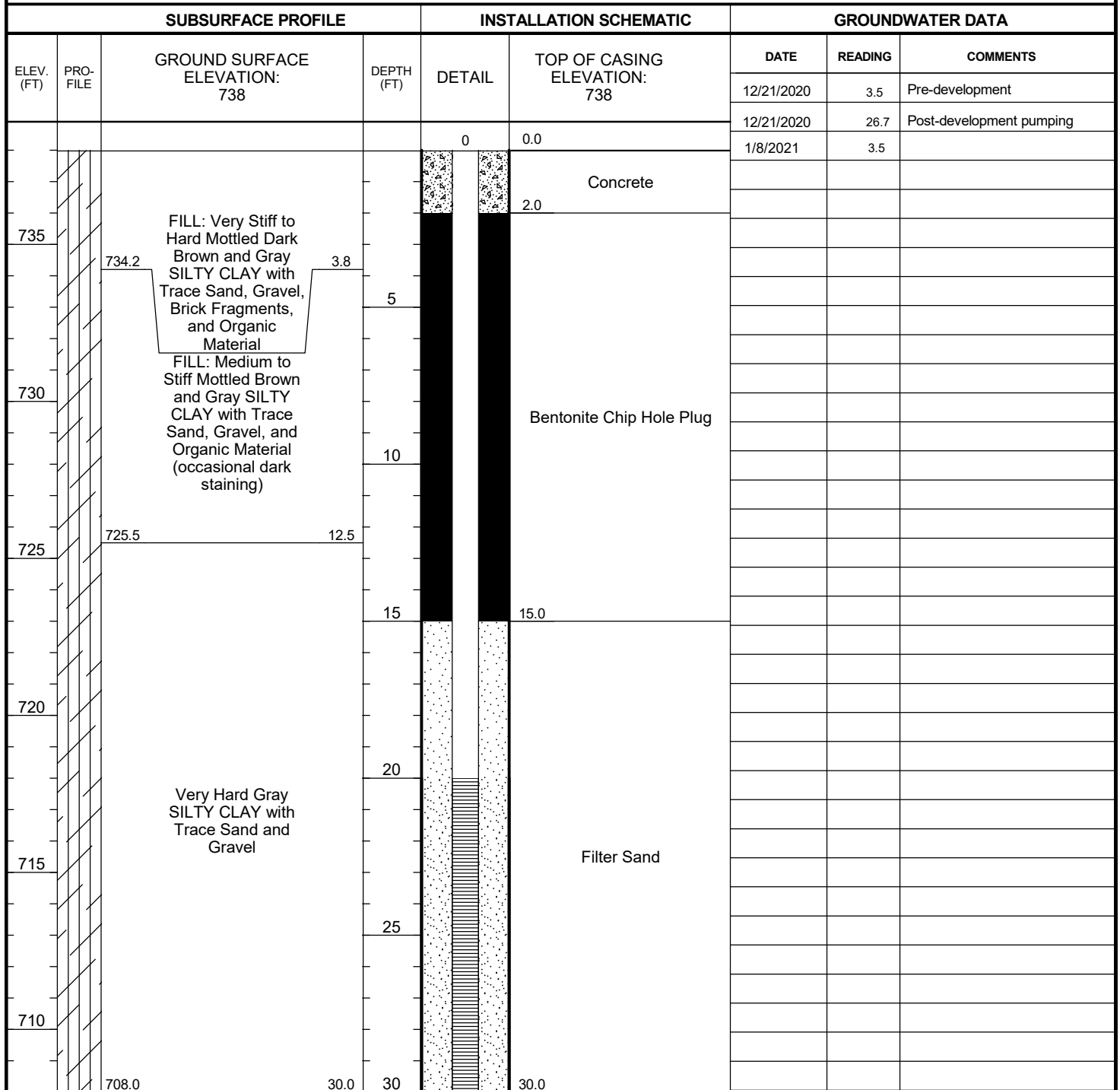

Total Depth: 40.0 ft
 Drilling Date: 12/18/2020
 Inspector: J. Elsey, PE
 Contractor: Schmidt Drilling Co.
 Driller: M. Schmidt
 Equipment:

Notes:
 1) Screened interval from 20 to 30 feet deep.

Casing Diameter: 2 in
 Casing Length: 20 ft
 Casing Type: PVC

Screen Diameter: 2 in
 Screen Length: 10 ft
 Screen Mesh: .10 in
 Screen Type: PVC

Protective Casing: *Flush mount at surface.*

Coordinates:

WELL LOG 20-191 LOGS.GPJ 1/5/21

FIGURE NO. 5

Monitoring Well NO: TB-1

Project Name: *Clear Well Dewatering Analysis*

Project Location: *Ann Arbor Waste Water Treatment Plant*



FK Engineering Associates

Project No: 20-191

Checked By: S. Kucharek

SUBSURFACE PROFILE				INSTALLATION SCHEMATIC		GROUNDWATER DATA		
ELEV. (FT)	PRO-FILE	GROUND SURFACE ELEVATION: 738	DEPTH (FT)	DETAIL	TOP OF CASING ELEVATION: 738	DATE	READING	COMMENTS
				0				
705		Very Hard Gray SILTY CLAY with Trace Sand and Gravel		Filter Sand	40.0			
700			35					
		698.0	40.0					
695								
690								
685								
680								
675								
670								

WELL LOG 20-191 LOGS.GPJ 1/5/21

Monitoring Well NO: TB-2

Project Name: *Clear Well Dewatering Analysis*

Project Location: *Ann Arbor Waste Water Treatment Plant*



FK Engineering Associates

Project No: 20-191

Checked By: S. Kucharek

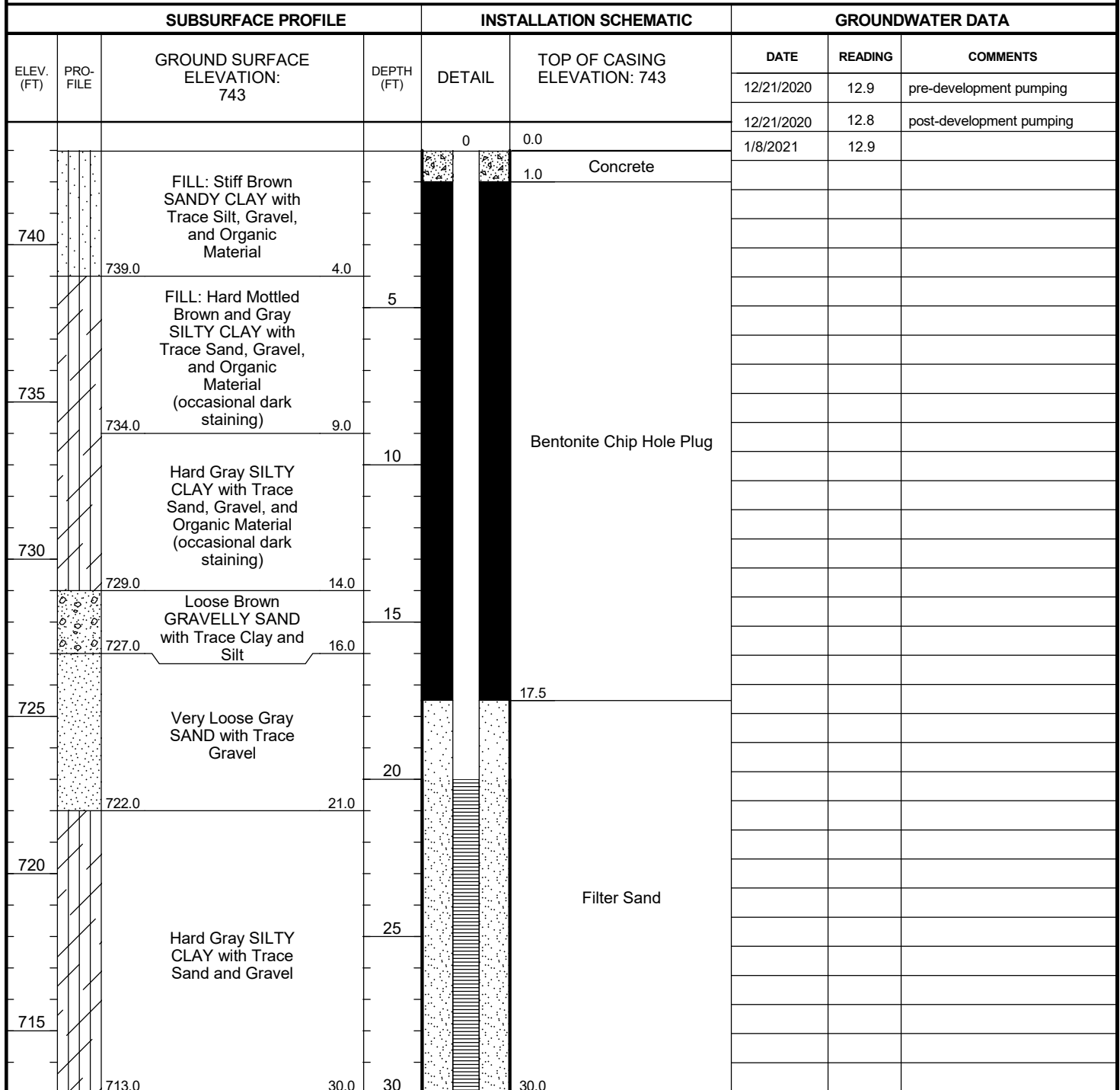

Total Depth: 44.4 ft
 Drilling Date: 12/19/20
 Inspector: J. Eisey, PE
 Contractor: Schmidt Drilling Co.
 Driller: M. Schmidt
 Equipment:

Casing Diameter: 2 in
 Casing Length: 20 ft
 Casing Type: PVC

Screen Diameter: 2 in
 Screen Length: 10 ft
 Screen Mesh: .10 in
 Screen Type: PVC

Notes:

1) Screened interval from 20 to 30 feet deep.

Protective Casing: *Flush mount at surface.*

Coordinates:

WELL LOG 20-191 LOGS.GPJ 1/11/21

FIGURE NO. 6

Monitoring Well NO: TB-2

Project Name: *Clear Well Dewatering Analysis*

Project Location: *Ann Arbor Waste Water Treatment Plant*



FK Engineering Associates

Project No: 20-191

Checked By: S. Kucharek

SUBSURFACE PROFILE				INSTALLATION SCHEMATIC		GROUNDWATER DATA		
ELEV. (FT)	PRO-FILE	GROUND SURFACE ELEVATION: 743	DEPTH (FT)	DETAIL	TOP OF CASING ELEVATION: 743	DATE	READING	COMMENTS
				0				
710		Hard Gray SILTY CLAY with Trace Sand and Gravel						
		709.5 709.0	33.5 34.0					
		Very Compact Gray SILTY SAND with Trace Clay and Gravel	35					
705					Filter Sand			
		Hard Gray SILTY CLAY with Trace Sand and Gravel	40					
700								
		698.8 698.6	44.2 44.4		44.4			
		Very Compact Gray SAND						
695								
690								
685								
680								
675								

WELL LOG 20-191 LOGS.GPJ 1/11/21



TABULATION OF LABORATORY TEST DATA																				
Boring / Test Pit / Probe Designation	Sample Number	Depth of Sample Tip (ft)	Elevation of Sample Tip (ft)	Unconfined Compressive Strength (psf)	Failure Strain (%)	Natural Water Content (% of dry weight)	In-Place Dry Density (lbs/cu.ft)	Permeability (cm/sec)	PARTICLE SIZE DISTRIBUTION (%)						ATTERBERG LIMITS (%)			Apparent Specific Gravity	ASTM D2974 Organic Matter (%)	Unified Soil Classification
									Clay	Silt	Fine Sand	Medium Sand	Coarse Sand	Gravel	Liquid Limit	Plastic Limit	Plasticity Index			
TB-1	S-10	40.0	698.0	28,061	15.0	10.6	131.0	-	-	-	-	-	-	-	-	-	-	-	-	
TB-2	S-5	15.0	728.0	-	-	12.2	-	-	5.5	42.4	29.3	7.7	15.2	-	-	-	-	-	-	
TB-2	S-7	22.5	720.5	16,074	9.1	8.8	138.4	-	-	-	-	-	-	-	-	-	-	-	-	

Figure No. 7



Unconfined Compressive Strength Test

30425 Stephenson Hwy,
Madison Heights, MI 48071

Job No. 20-191
Sample No. TB-1 S-10

Date 1/3/2021
Tester JME

Initial Height 3.1 in

Wet Soil Weight 187.7 g

Initial Diameter 1.4 in

Dry Soil Weight 169.7 g

Initial Area 1.6 in²

Water Content 10.6 %

Initial Volume 4.9 in³

Dry Density in pcf 131.0 pcf

Total Strain	Stress (psf)
0.1%	0
0.4%	8
1.4%	2,666
2.4%	5,151
3.4%	7,116
4.4%	8,762
5.4%	10,579
6.4%	12,546
7.4%	14,537
7.9%	15,437
8.4%	16,450
8.9%	17,397
9.4%	18,474
10.4%	19,384
11.4%	21,342
12.4%	23,229
13.4%	24,947
14.4%	26,447
15.0%	27,719

Strain Rate
1% per min

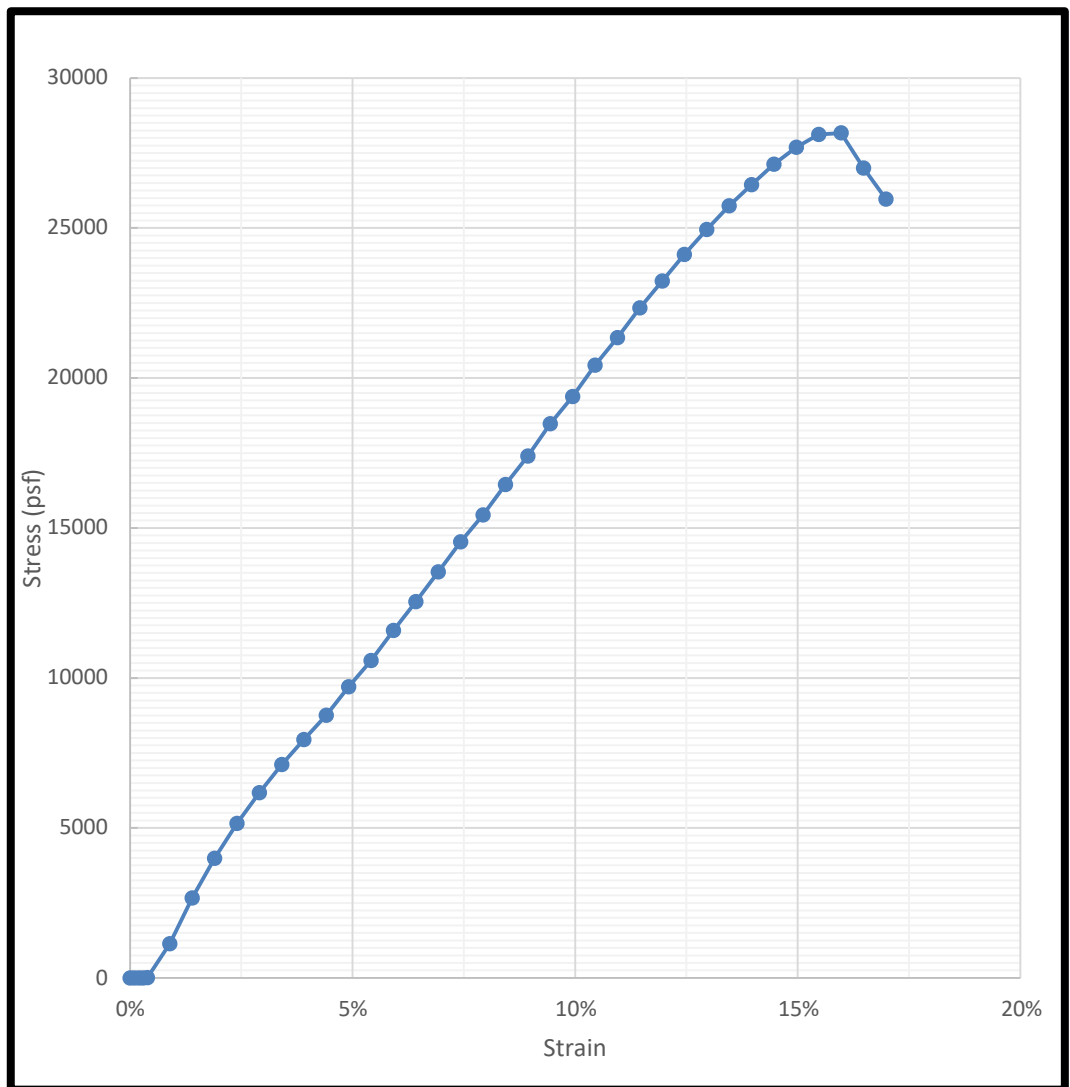

Figure No. 8



Sieve Gradation Determination

30425 Stephenson Hwy
Madison Heights, MI 48071

Job Number	20-191
Sample Number	TB-2 S-5
Date	1/3/2021

Tester	SAK
Dry Density	N/A
Water Content	12.2%

% Gravel (> No. 4)	15.2%
% Coarse Sand (No. 4 to No. 10)	7.7%
% Medium Sand (No. 10 to No. 40)	29.3%
% Fine Sand (No. 40 to No. 200)	42.4%
% Silt/Clay (<0.075 mm)	5.5%

Diameter	% Passing
4.75	84.8%
2	77.1%
0.85	66.2%
0.425	47.8%
0.25	30.0%
0.15	16.3%
0.075	5.5%

D ₁₀	D ₃₀	D ₆₀
0.11	0.27	0.71

C _u
6.7

C _c
0.97

Gradation

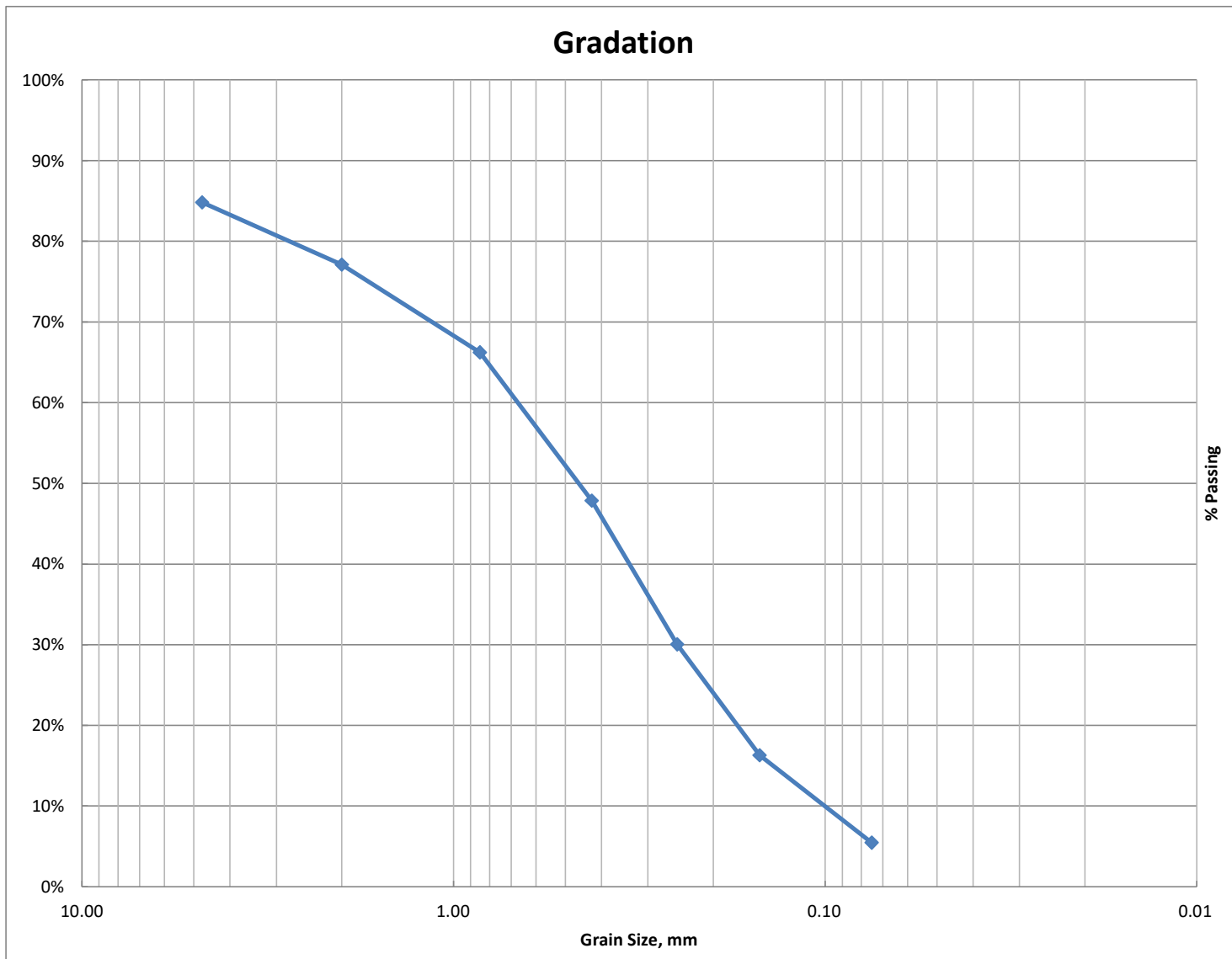



Unconfined Compressive Strength Test

30425 Stephenson Hwy,
Madison Heights, MI 48071

Job No. 20-191
Sample No. TB-2 S-7

Date 1/3/2020
Tester JME

Initial Height 2.9 in

Wet Soil Weight 178.5 g

Initial Diameter 1.4 in

Dry Soil Weight 164 g

Initial Area 1.6 in²

Water Content 8.8 %

Initial Volume 4.5 in³

Dry Density in pcf 138.4 pcf

Total Strain	Stress (psf)
0.1%	11
0.4%	377
1.4%	3,214
2.5%	6,014
3.5%	8,632
4.5%	10,929
5.5%	12,667
6.5%	14,316
7.5%	15,571
8.0%	15,887
8.6%	16,008
9.1%	16,074

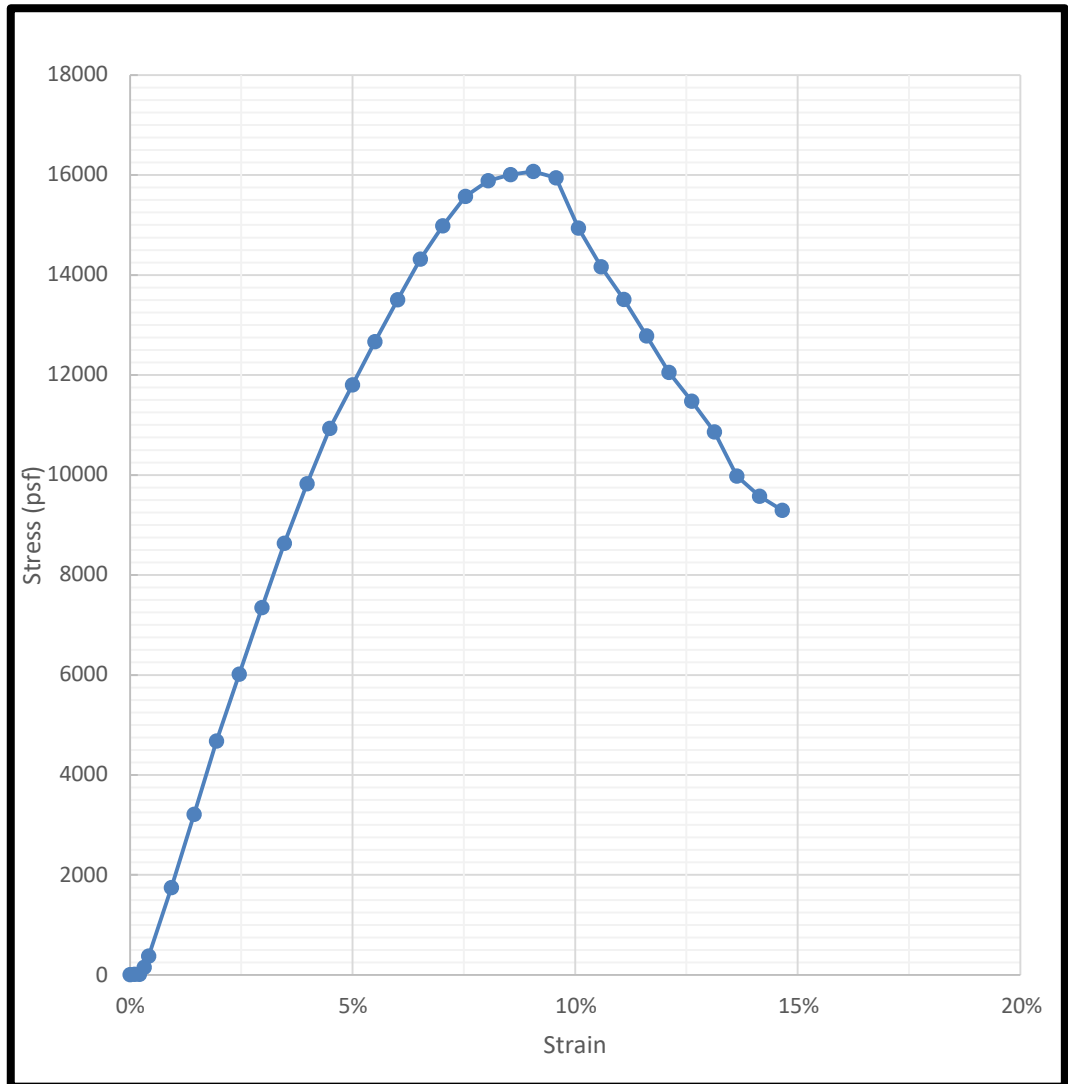

Strain Rate
1% per min

Slug in 1 - Bower-Rice

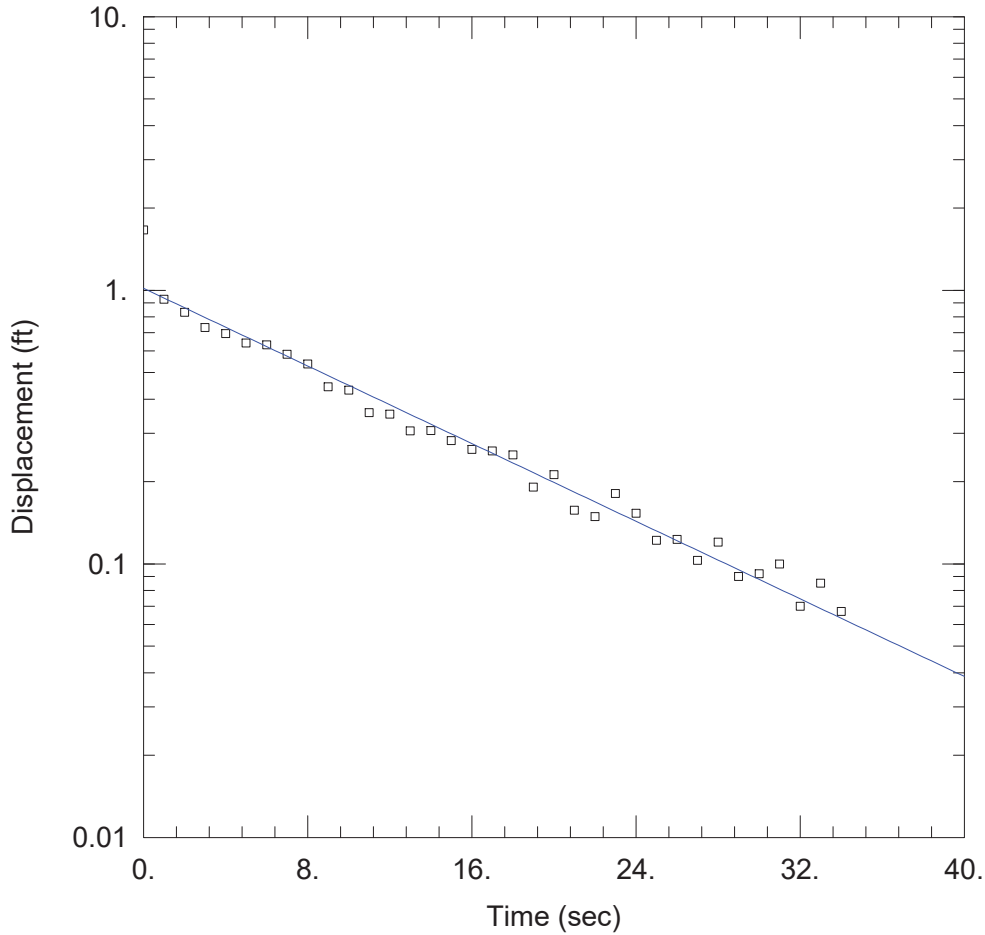

WELL TEST ANALYSIS

Data Set: S:\...\Slug in 1.aqt
 Date: 12/22/20

Time: 13:28:06

PROJECT INFORMATION

Company: FK Engineering
 Client: OHM
 Project: 20-191
 Location: Ann Arbor, MI
 Test Well: TB-2 MW-2
 Test Date: 12/21/2020

AQUIFER DATA

Saturated Thickness: 21. ft

Anisotropy Ratio (Kz/Kr): 1.

WELL DATA (New Well)

Initial Displacement: 12.9 ft
 Total Well Penetration Depth: 17.1 ft
 Casing Radius: 0.083 ft

Static Water Column Height: 17.1 ft
 Screen Length: 10. ft
 Well Radius: 0.083 ft

SOLUTION

Aquifer Model: Unconfined

Solution Method: Bower-Rice

K = 0.002357 cm/sec

$y_0 =$ 1.016 ft

Slug in 1 - Hvorslev

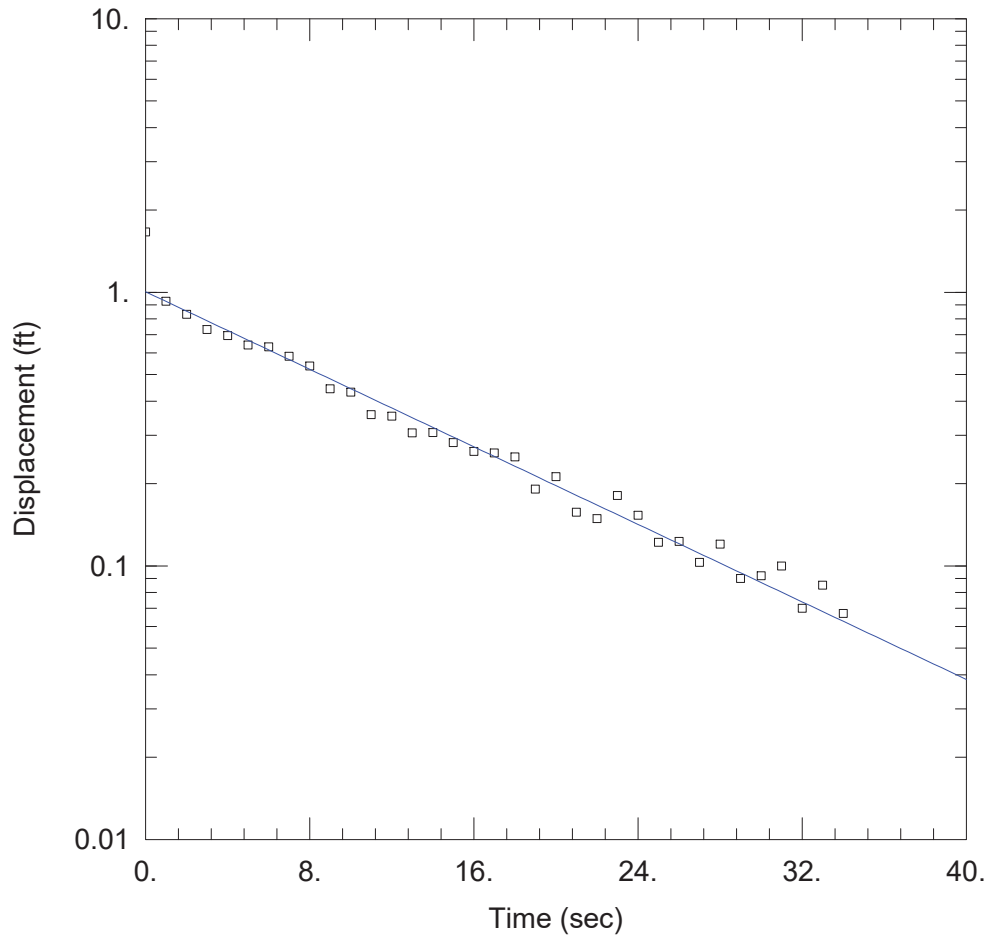

WELL TEST ANALYSIS

Data Set: S:\...\Slug in 1 Hvorslev.aqt
 Date: 12/22/20

Time: 13:30:01

PROJECT INFORMATION

Company: FK Engineering
 Client: OHM
 Project: 20-191
 Location: Ann Arbor, MI
 Test Well: TB-2 MW-2
 Test Date: 12/21/2020

AQUIFER DATA

Saturated Thickness: 21. ft

Anisotropy Ratio (Kz/Kr): 1.

WELL DATA (New Well)

Initial Displacement: 12.9 ft
 Total Well Penetration Depth: 17.1 ft
 Casing Radius: 0.083 ft

Static Water Column Height: 17.1 ft
 Screen Length: 10. ft
 Well Radius: 0.083 ft

SOLUTION

Aquifer Model: Unconfined

Solution Method: Hvorslev

K = 0.003076 cm/sec

y_0 = 1.004 ft

Slug in 2 - Bower-Rice

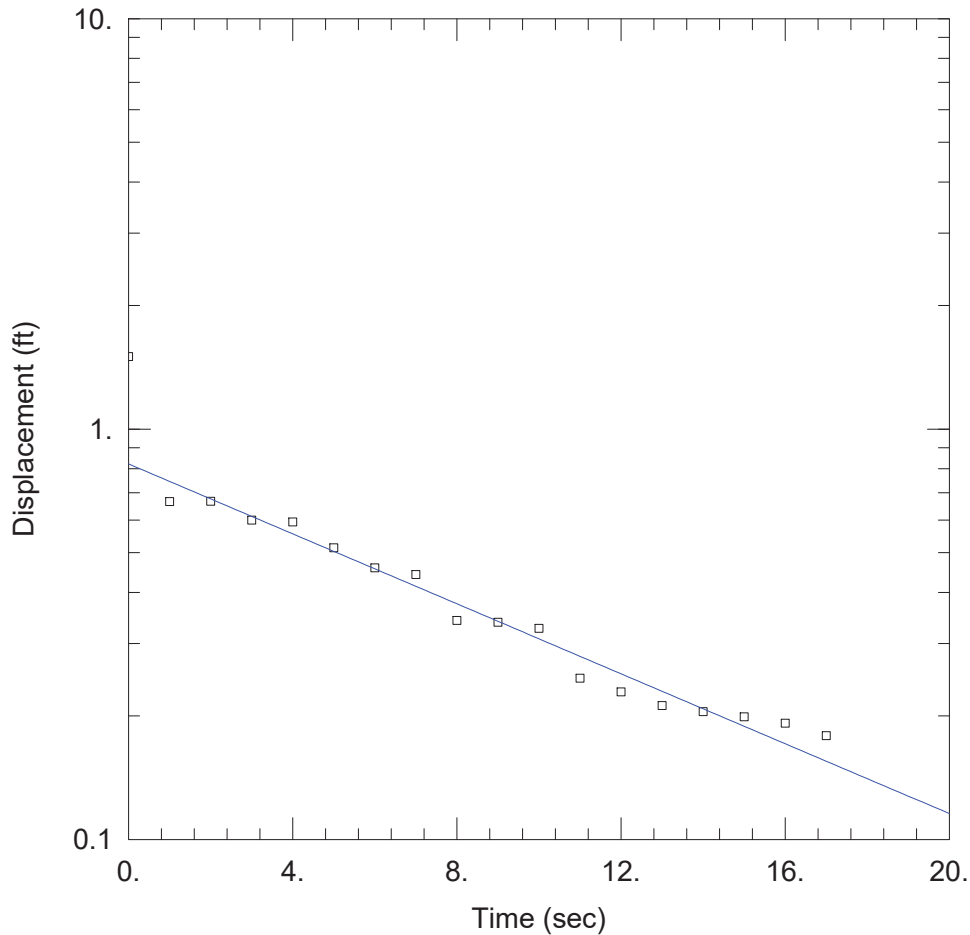

WELL TEST ANALYSIS

Data Set: S:\...\Slug In 2 Bouwer-Rice.aqt
 Date: 12/22/20

Time: 13:45:17

PROJECT INFORMATION

Company: FK Engineering
 Client: OHM
 Project: 20-191
 Location: Ann Arbor, MI
 Test Well: TB-2 MW-2
 Test Date: 12/21/2020

AQUIFER DATA

Saturated Thickness: 21. ft

Anisotropy Ratio (Kz/Kr): 1.

WELL DATA (New Well)

Initial Displacement: 12.9 ft
 Total Well Penetration Depth: 17.1 ft
 Casing Radius: 0.083 ft

Static Water Column Height: 17.1 ft
 Screen Length: 10. ft
 Well Radius: 0.083 ft

SOLUTION

Aquifer Model: Unconfined

Solution Method: Bouwer-Rice

K = 0.002831 cm/sec

y0 = 0.822 ft

Slug in 2 - Hvorslev

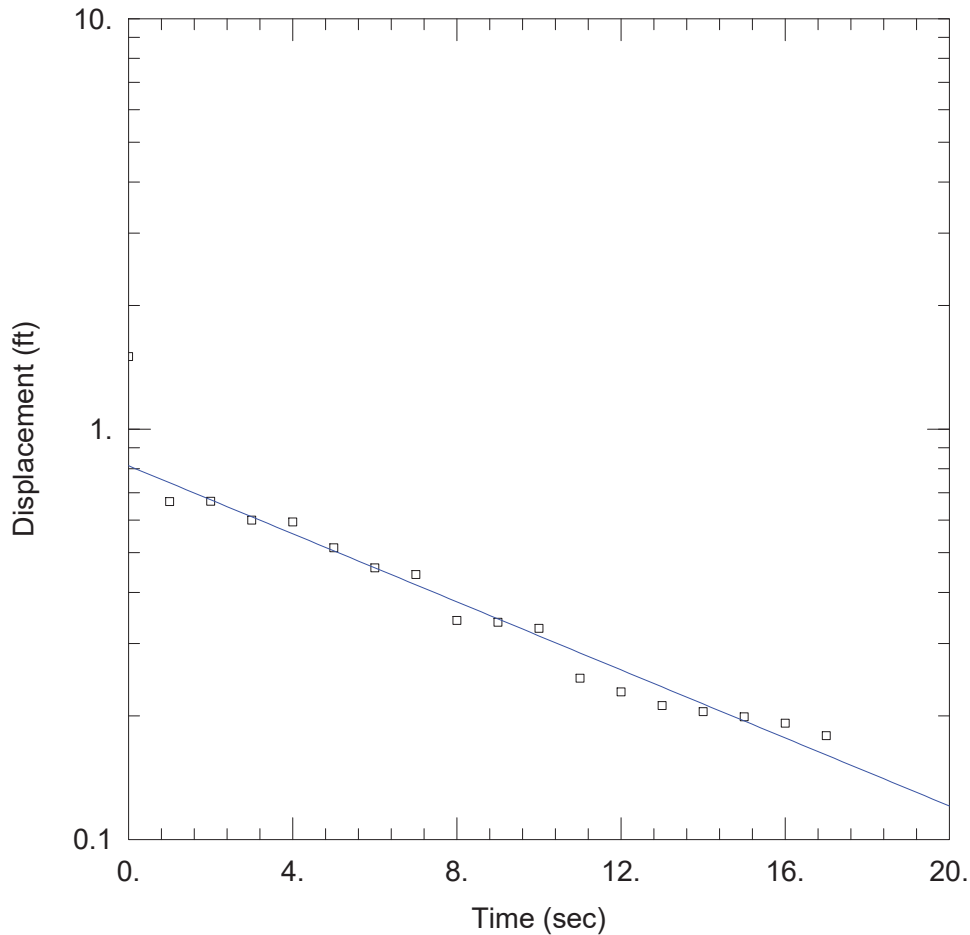

WELL TEST ANALYSIS

Data Set: S:\...\Slug In 2 Hvorslev.aqt
 Date: 12/22/20

Time: 13:46:23

PROJECT INFORMATION

Company: FK Engineering
 Client: OHM
 Project: 20-191
 Location: Ann Arbor, MI
 Test Well: TB-2 MW-2
 Test Date: 12/21/2020

AQUIFER DATA

Saturated Thickness: 21. ft

Anisotropy Ratio (Kz/Kr): 1.

WELL DATA (New Well)

Initial Displacement: 12.9 ft
 Total Well Penetration Depth: 17.1 ft
 Casing Radius: 0.083 ft

Static Water Column Height: 17.1 ft
 Screen Length: 10. ft
 Well Radius: 0.083 ft

SOLUTION

Aquifer Model: Unconfined

Solution Method: Hvorslev

K = 0.003599 cm/sec

y0 = 0.8138 ft

Slug in 3 - Bower-Rice

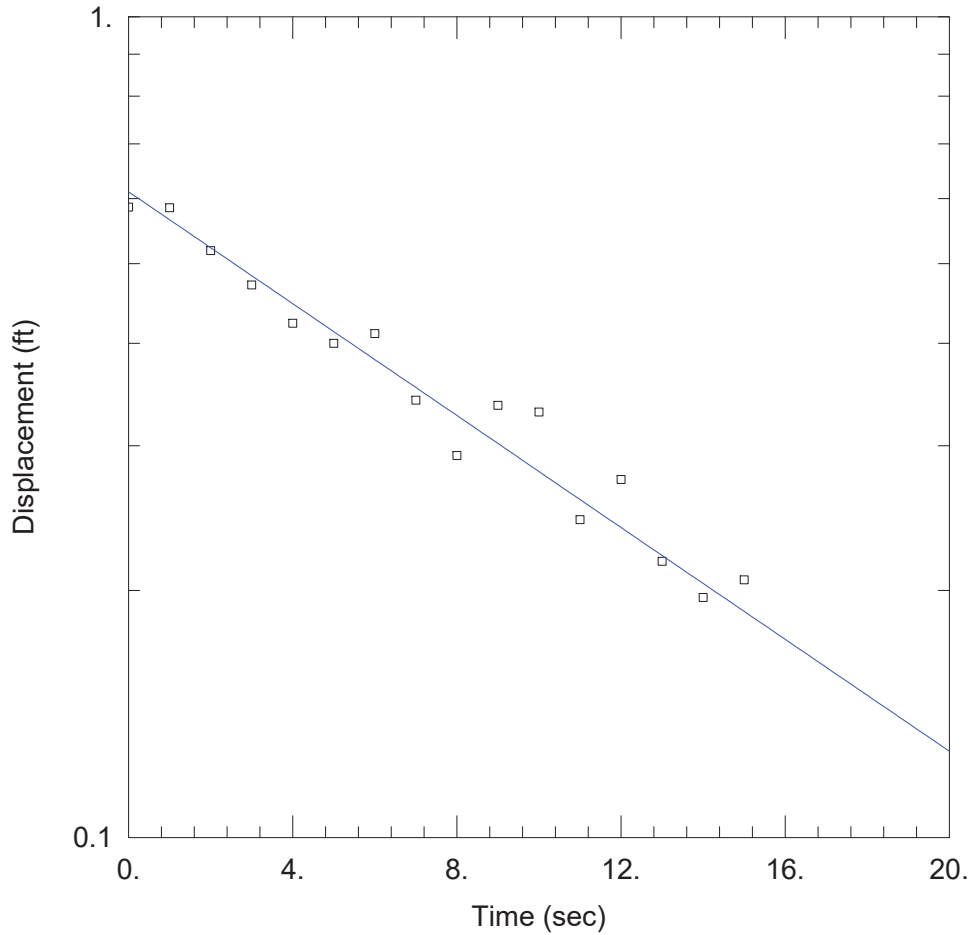

WELL TEST ANALYSIS

Data Set: S:\...\Slug in 3 Bower-Rice.aqt

Date: 12/22/20

Time: 13:54:37

PROJECT INFORMATION

Company: FK Engineering

Client: OHM

Project: 20-191

Location: Ann Arbor, MI

Test Well: TB-2 MW-2

Test Date: 12/21/2020

AQUIFER DATA

Saturated Thickness: 21. ft

Anisotropy Ratio (Kz/Kr): 1.

WELL DATA (New Well)

Initial Displacement: 12.9 ft

Static Water Column Height: 17.1 ft

Total Well Penetration Depth: 17.1 ft

Screen Length: 10. ft

Casing Radius: 0.083 ft

Well Radius: 0.083 ft

SOLUTION

Aquifer Model: Unconfined

Solution Method: Bower-Rice

K = 0.002265 cm/sec

y0 = 0.6118 ft

Slug in 3 - Hvorslev

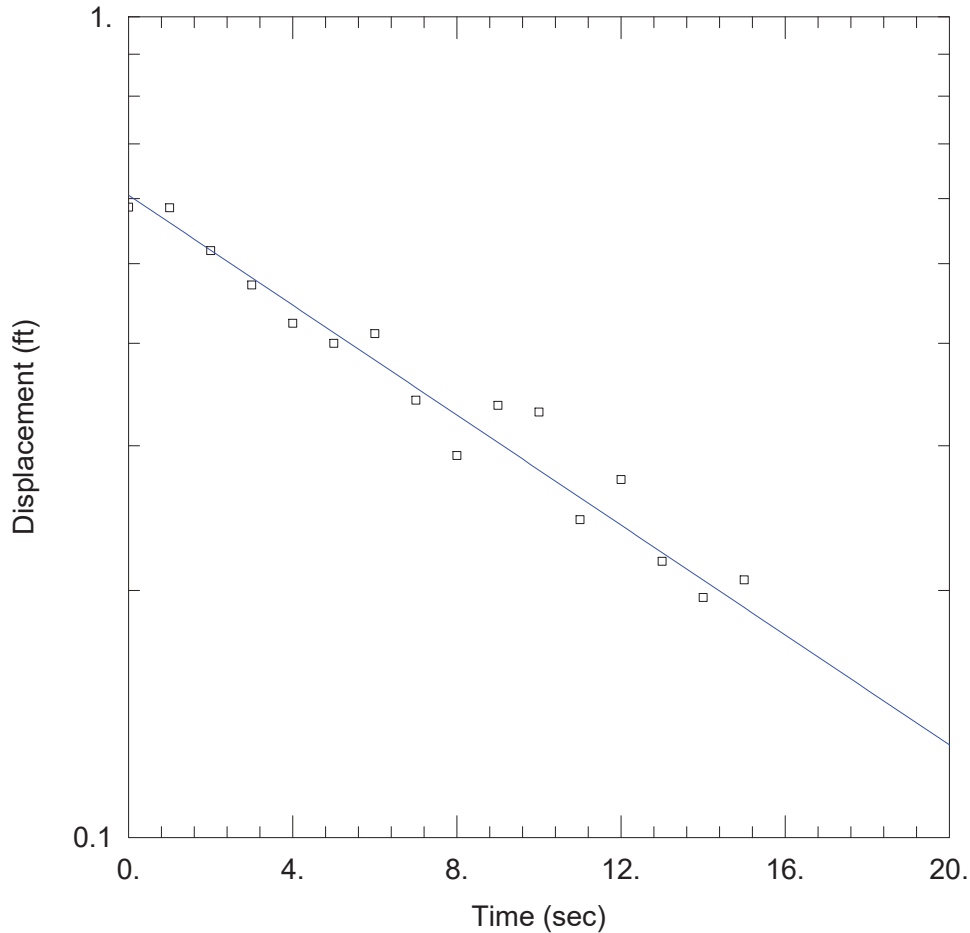

WELL TEST ANALYSIS

Data Set: S:\...\Slug in 3 Hvorslev.aqt
 Date: 12/22/20

Time: 13:55:30

PROJECT INFORMATION

Company: FK Engineering
 Client: OHM
 Project: 20-191
 Location: Ann Arbor, MI
 Test Well: TB-2 MW-2
 Test Date: 12/21/2020

AQUIFER DATA

Saturated Thickness: 21. ft

Anisotropy Ratio (Kz/Kr): 1.

WELL DATA (New Well)

Initial Displacement: 12.9 ft
 Total Well Penetration Depth: 17.1 ft
 Casing Radius: 0.083 ft

Static Water Column Height: 17.1 ft
 Screen Length: 10. ft
 Well Radius: 0.083 ft

SOLUTION

Aquifer Model: Unconfined

Solution Method: Hvorslev

K = 0.002908 cm/sec

y_0 = 0.6059 ft

Slug out 1 - Bower-Rice

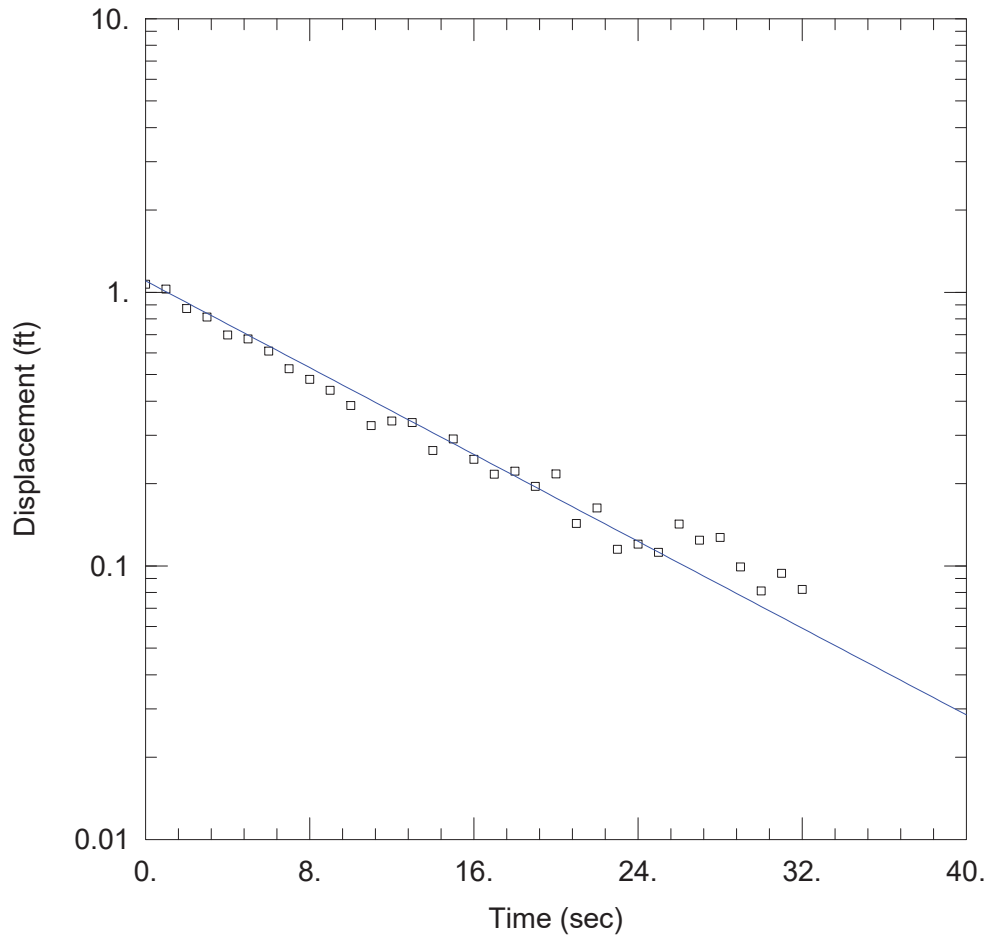

WELL TEST ANALYSIS

Data Set: S:\...\Slug out 1 Bower-Rice.aqt

Date: 12/22/20

Time: 13:40:40

PROJECT INFORMATION

Company: FK Engineering

Client: OHM

Project: 20-191

Location: Ann Arbor, MI

Test Well: TB-2 MW-2

Test Date: 12/21/2020

AQUIFER DATA

Saturated Thickness: 21. ft

Anisotropy Ratio (Kz/Kr): 1.

WELL DATA (New Well)

Initial Displacement: 12.9 ft

Static Water Column Height: 17.1 ft

Total Well Penetration Depth: 17.1 ft

Screen Length: 10. ft

Casing Radius: 0.083 ft

Well Radius: 0.083 ft

SOLUTION

Aquifer Model: Unconfined

Solution Method: Bower-Rice

K = 0.002636 cm/sec

y0 = 1.101 ft

Figure No. 17

Slug out 1 - Hvorslev

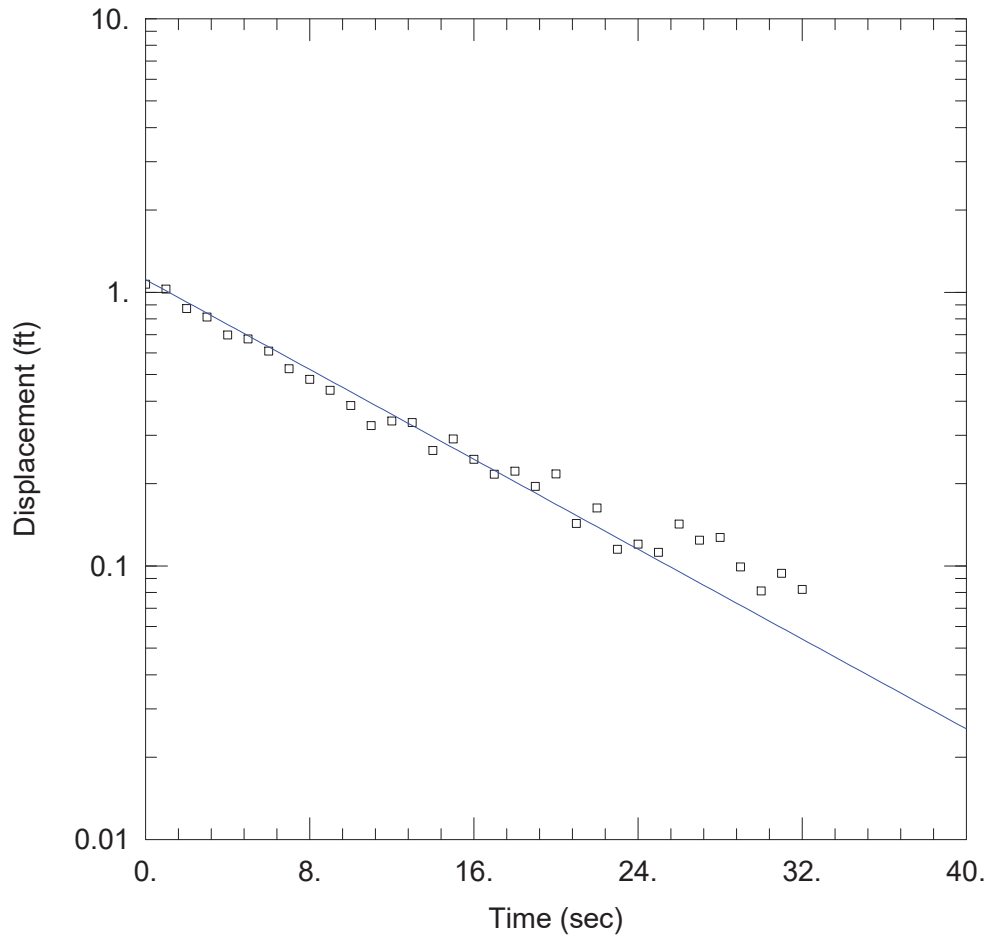

WELL TEST ANALYSIS

Data Set: S:\...\Slug out 1 Hvorslev.aqt
 Date: 12/22/20

Time: 13:41:23

PROJECT INFORMATION

Company: FK Engineering
 Client: OHM
 Project: 20-191
 Location: Ann Arbor, MI
 Test Well: TB-2 MW-2
 Test Date: 12/21/2020

AQUIFER DATA

Saturated Thickness: 21. ft

Anisotropy Ratio (Kz/Kr): 1.

WELL DATA (New Well)

Initial Displacement: 12.9 ft
 Total Well Penetration Depth: 17.1 ft
 Casing Radius: 0.083 ft

Static Water Column Height: 17.1 ft
 Screen Length: 10. ft
 Well Radius: 0.083 ft

SOLUTION

Aquifer Model: Unconfined

Solution Method: Hvorslev

K = 0.003566 cm/sec

y0 = 1.112 ft

Slug out 2 - Bower-Rice

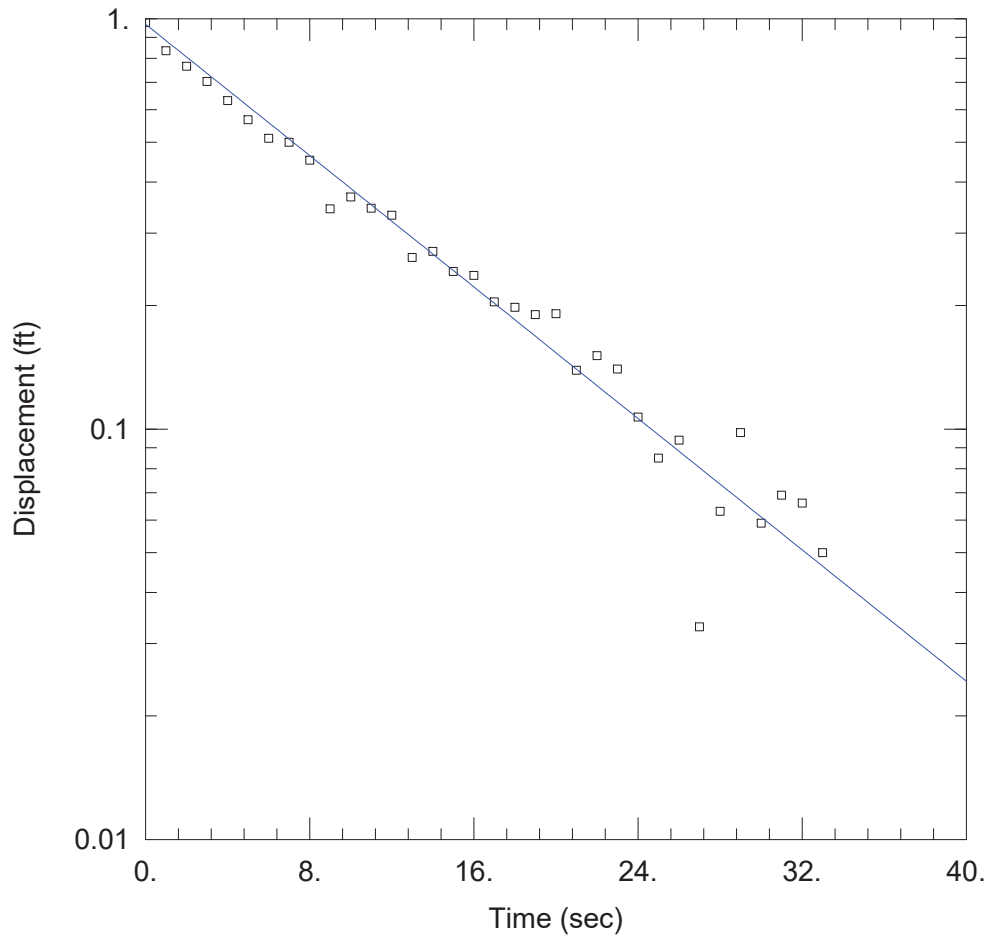

WELL TEST ANALYSIS

Data Set: S:\...\Slug Out 2 Bower-Rice.aqt

Date: 12/22/20

Time: 13:49:56

PROJECT INFORMATION

Company: FK Engineering

Client: OHM

Project: 20-191

Location: Ann Arbor, MI

Test Well: TB-2 MW-2

Test Date: 12/21/2020

AQUIFER DATA

Saturated Thickness: 21. ft

Anisotropy Ratio (Kz/Kr): 1.

WELL DATA (New Well)

Initial Displacement: 12.9 ft

Static Water Column Height: 17.1 ft

Total Well Penetration Depth: 17.1 ft

Screen Length: 10. ft

Casing Radius: 0.083 ft

Well Radius: 0.083 ft

SOLUTION

Aquifer Model: Unconfined

Solution Method: Bower-Rice

K = 0.00266 cm/sec

y0 = 0.9692 ft

Slug out 2 - Hvorslev

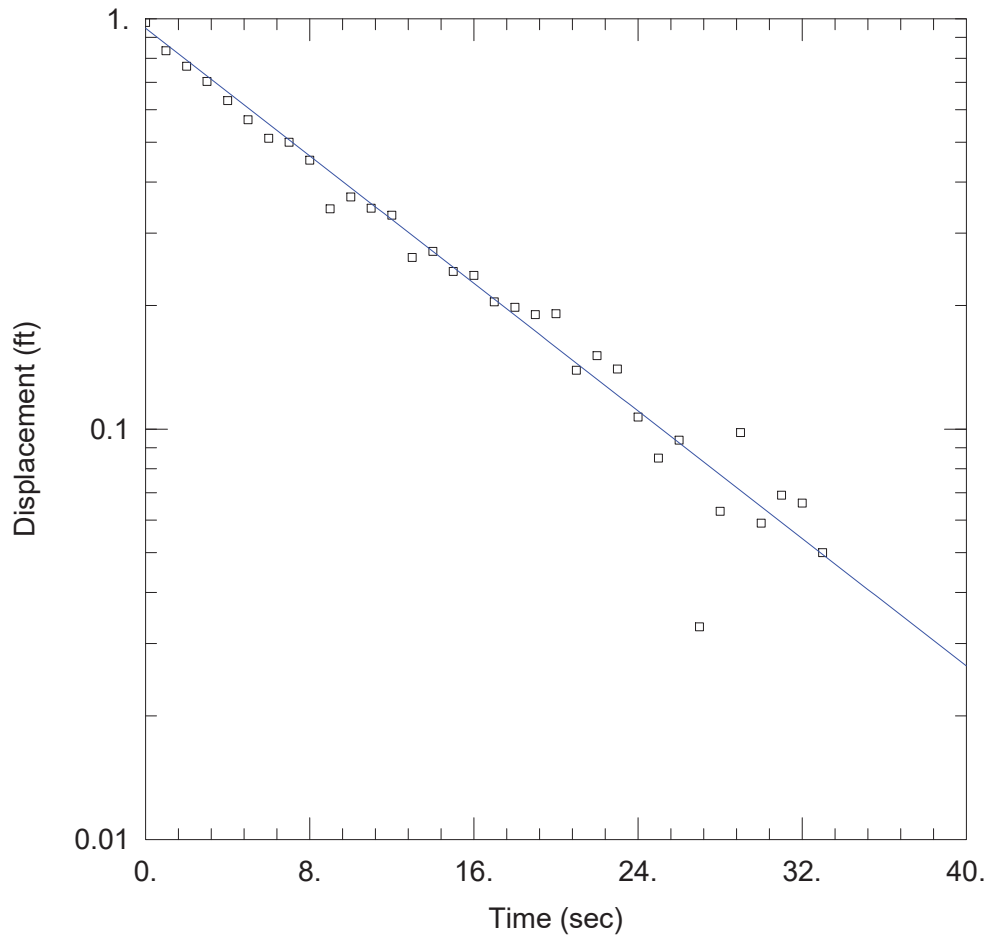

WELL TEST ANALYSIS

Data Set: S:\...\Slug Out 2 Hvorslev.aqt
 Date: 12/22/20

Time: 13:50:34

PROJECT INFORMATION

Company: FK Engineering
 Client: OHM
 Project: 20-191
 Location: Ann Arbor, MI
 Test Well: TB-2 MW-2
 Test Date: 12/21/2020

AQUIFER DATA

Saturated Thickness: 21. ft

Anisotropy Ratio (Kz/Kr): 1.

WELL DATA (New Well)

Initial Displacement: 12.9 ft
 Total Well Penetration Depth: 17.1 ft
 Casing Radius: 0.083 ft

Static Water Column Height: 17.1 ft
 Screen Length: 10. ft
 Well Radius: 0.083 ft

SOLUTION

Aquifer Model: Unconfined

Solution Method: Hvorslev

K = 0.003373 cm/sec

y_0 = 0.9469 ft

Slug out 3 - Bower-Rice

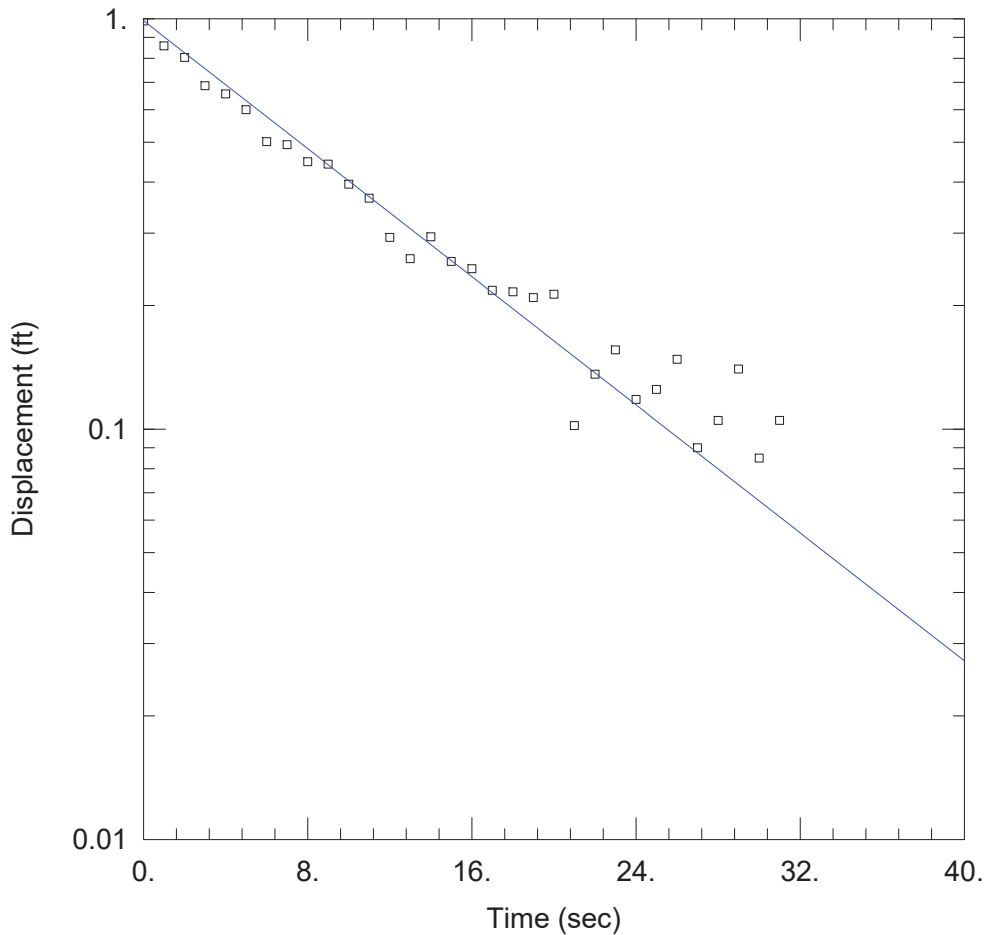

WELL TEST ANALYSIS

Data Set: S:\...\Slug Out 3 Bower-Rice.aqt

Date: 12/22/20

Time: 13:58:29

PROJECT INFORMATION

Company: FK Engineering

Client: OHM

Project: 20-191

Location: Ann Arbor, MI

Test Well: TB-2 MW-2

Test Date: 12/21/2020

AQUIFER DATA

Saturated Thickness: 21. ft

Anisotropy Ratio (Kz/Kr): 1.

WELL DATA (New Well)

Initial Displacement: 12.9 ft

Static Water Column Height: 17.1 ft

Total Well Penetration Depth: 17.1 ft

Screen Length: 10. ft

Casing Radius: 0.083 ft

Well Radius: 0.083 ft

SOLUTION

Aquifer Model: Unconfined

Solution Method: Bower-Rice

K = 0.002592 cm/sec

y0 = 0.9883 ft

Figure No. 21

Slug out 3 - Hvorslev

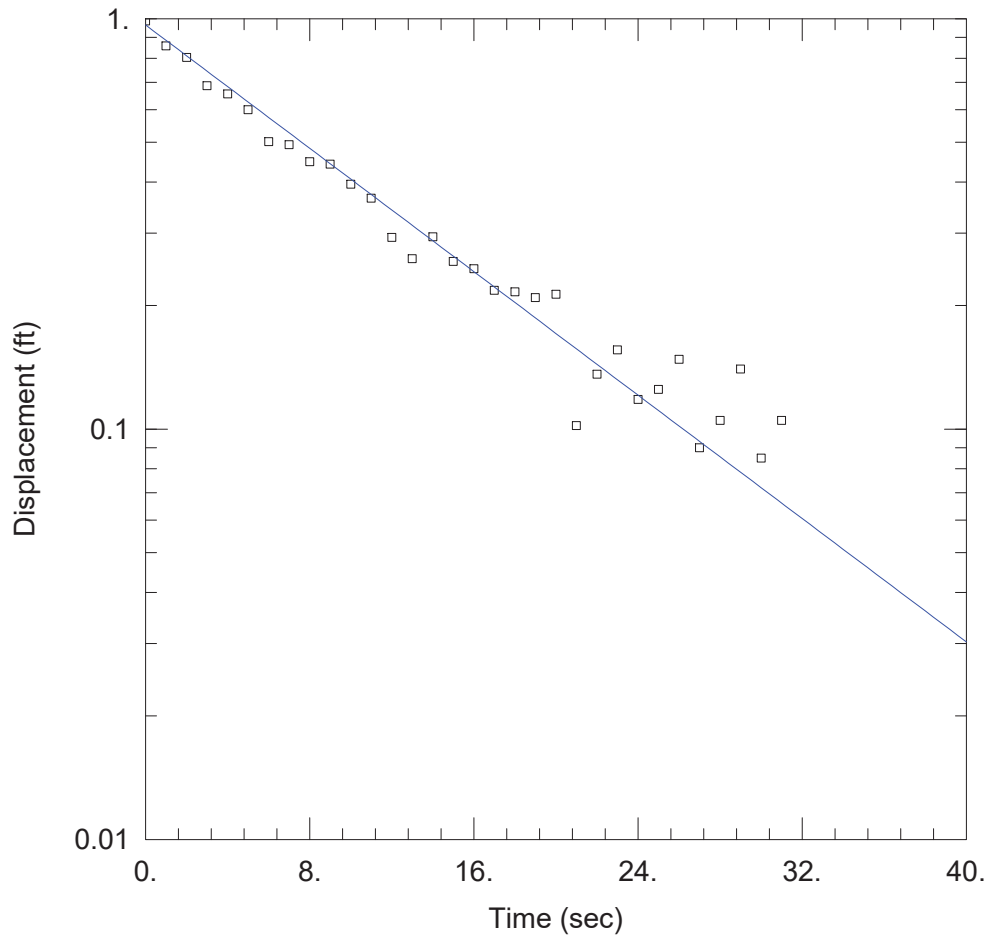

WELL TEST ANALYSIS

Data Set: S:\...\Slug Out 3 Hvorslev.aqt
 Date: 12/22/20

Time: 13:59:05

PROJECT INFORMATION

Company: FK Engineering
 Client: OHM
 Project: 20-191
 Location: Ann Arbor, MI
 Test Well: TB-2 MW-2
 Test Date: 12/21/2020

AQUIFER DATA

Saturated Thickness: 21. ft

Anisotropy Ratio (Kz/Kr): 1.

WELL DATA (New Well)

Initial Displacement: 12.9 ft
 Total Well Penetration Depth: 17.1 ft
 Casing Radius: 0.083 ft

Static Water Column Height: 17.1 ft
 Screen Length: 10. ft
 Well Radius: 0.083 ft

SOLUTION

Aquifer Model: Unconfined

Solution Method: Hvorslev

K = 0.003263 cm/sec

y_0 = 0.9651 ft

OPTION A
PLASTIC
GATE

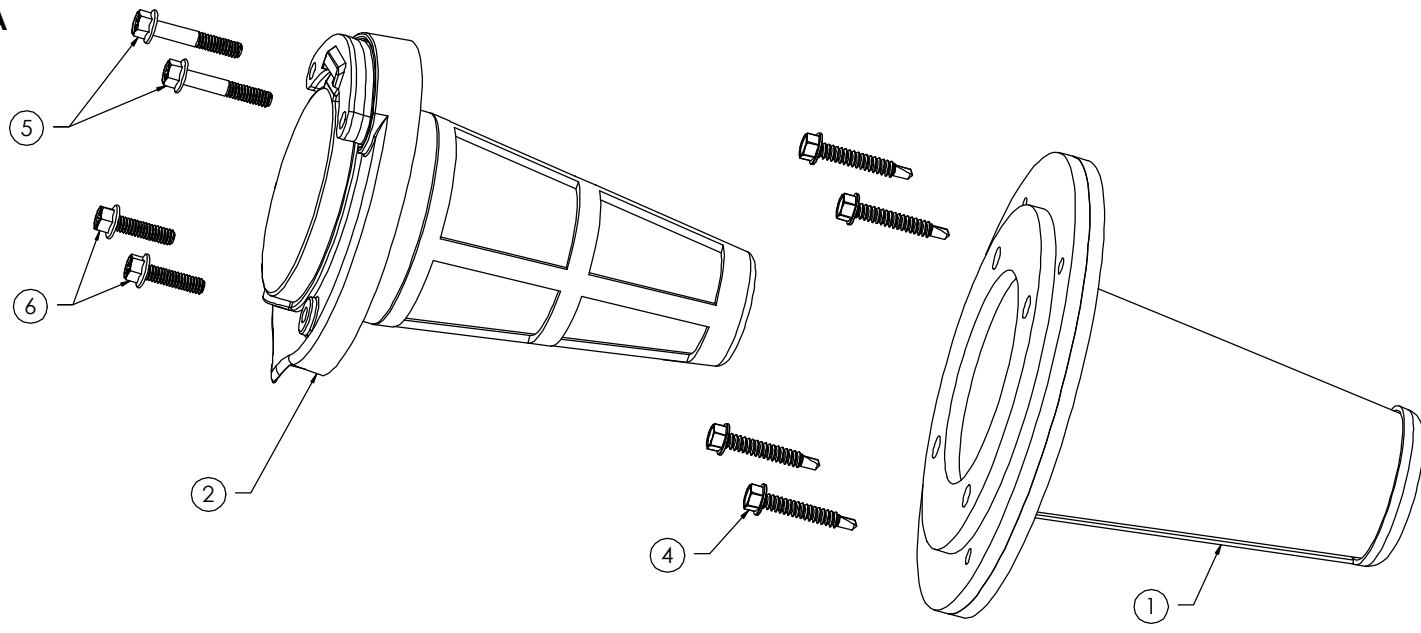

OPTION B
STAINLESS STEEL
LOUVERED
FACEPLATE

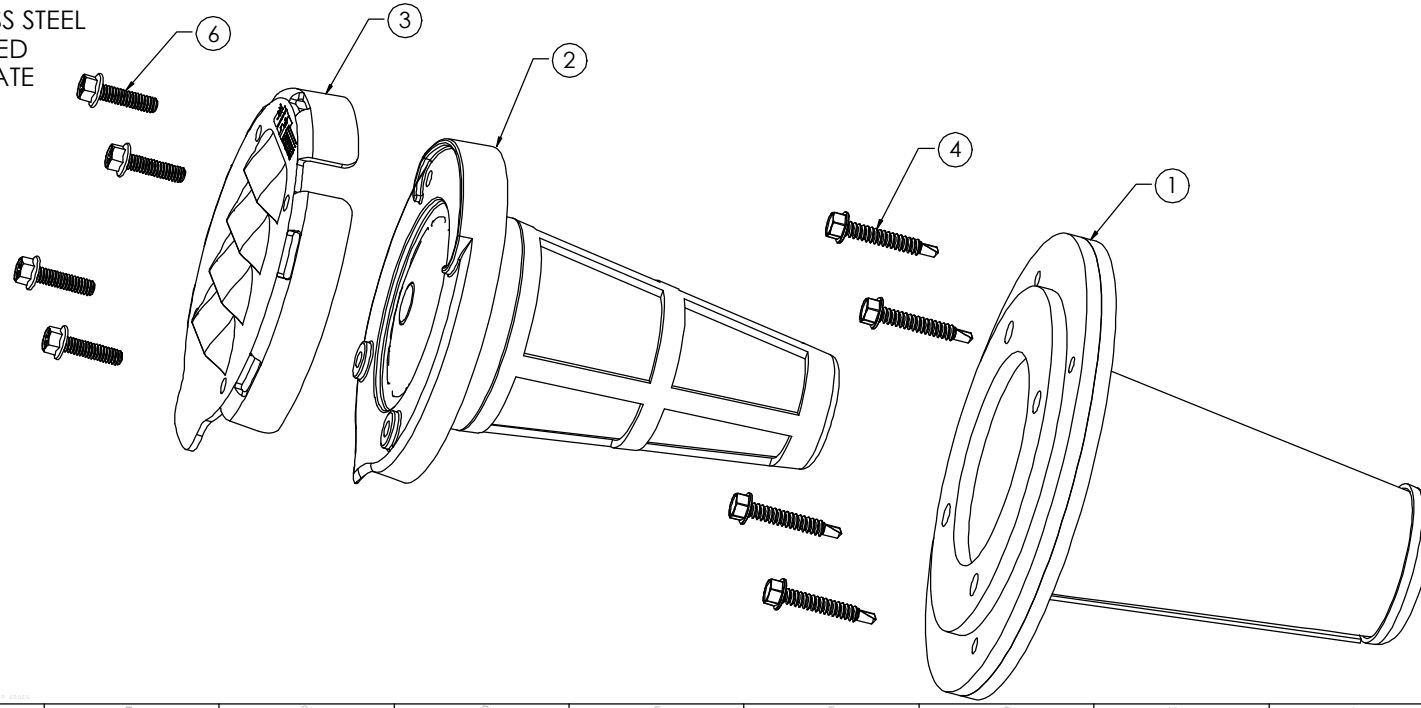

Jet Filter System / 14 N. Central Ave.
Casey, Illinois
info@jetfiltersystem.com / 800-475-2029

TOLERANCES UNLESS OTHERWISE SPECIFIED		FACEPLATE ASSEMBLY		REV
FRAMES	0.006 (max)	ADK	1-1	2
ADK	ADK	ADK	EV-10897	
1-3-18	2	2		

Figure No. 24

APPENDIX B: Clear Well Improvements

Relevant Historic Borings



FK Engineering Associates

Excellence in Infrastructure and Underground Engineering

LOG OF TEST BORING NO: TB-307A



NTH CONSULTANTS, LTD.

Project Name: AA WWTP

NTH Proj. No: 15-050510-04

Project Location: Ann Arbor, Michigan

Checked By: *elb*

SUBSURFACE PROFILE				SOIL SAMPLE DATA						
ELEV. (FT)	PRO-FILE	GROUND SURFACE ELEVATION: 735.9	DEPTH (FT.)	SAMP. TYPE/ NO.	BLOWS/ 6"	STD. PEN. RESIST. (N)	MOIST. CONT. (%)	DRY DENS. (pcf)	UNCONF. COMP. ST. (psf)	HNu READING (ppm)
735										
			5							
730										
			10							
725										
			15							
720										
		PROFILE DRILLED TO 33.5' See TB-103 and TB-307 for Profile	20							
715										
			25							
710										
			30							
705										
			33.5							
			35	LS-1	18 23 39	62			9000*	
700		Hard to Very Hard Gray SILTY CLAY with Trace Sand and Gravel								

Total Depth: 76 FT
 Drilling Date: 7-27-06 to 8-2-06
 Inspector: S. Gole/C. Johnson
 Contractor: American Drilling & Testing Co., Inc.
 Driller: J. Blank

Water Level Observation:

No groundwater encountered during drilling to 17'. No meaningful groundwater data from 17 to 74' due to the use of drilling fluids. 350 gpm artesian groundwater encountered at 74'.

Drilling Method:

CME 75 using 2 1/4" I.D. HSA to 17' then wash rotary using 3 7/8" tri-cone bit to EOB. Temporary 4" ID steel casing advanced to 30'.

Plugging Procedure:

Installed pneumatic piezometer PZ-307A.

Notes:

* = pocket penetrometer value

Groundwater measured at EL. 761.2 in stacked casing after completion of drilling.

LOG OF TEST BORING NO: TB-307A



NTH CONSULTANTS, LTD.

Project Name: AA WWTP

NTH Proj. No: 15-050510-04

Project Location: Ann Arbor, Michigan

Checked By: *elb*

SUBSURFACE PROFILE				SOIL SAMPLE DATA							
ELEV. (FT)	PRO-FILE	GROUND SURFACE ELEVATION: 735.9	DEPTH (FT.)	SAMP TYPE/ NO.	BLOWS/ 6"	STD PEN RESIST. (N)	MOIST CONT. (%)	DRY DENS (pcf)	UNCONF COMP ST (psf)	HNu READING (ppm)	
695		Hard to Very Hard Gray SILTY CLAY with Trace Sand and Gravel	40	LS-2	38 38 42	80	8.1		>9000*		
			GRAVEL COBBLE/BOULDER								
690				45	LS-3	21 24 29	53			>9000*	
685				50	LS-4	19 22 34	56			>9000*	
680				55	LS-5	22 36 44	80			NR	
675			Very Hard Gray SILTY CLAY with Trace Sand and Gravel	60	LS-6	36 50/6" -	50/6"			-	
670				65	LS-6	16 24 34	58			>9000*	
665			70	LS-	31 51 50/4"	101/10"			NR		
			74.0	LS-	100/6" - -	-			-		
660		Compact Gray SAND and GRAVEL with Trace Silt	75	LS-7	12 16 32	48			-		
		END OF BORING	76.0								
655			80								

LOG OF TEST BORING NO: TB-506

Project Name: *Ann Arbor Wastewater Treatment Plant*
 Project Location: *Ann Arbor, Michigan*



NTH Consultants, Ltd.

NTH Proj. No.: 15-050510-11

Checked By: *[Signature]*

SUBSURFACE PROFILE					SOIL SAMPLE DATA												
ELEV. (FT)	PRO-FILE	ELEV	GROUND SURFACE ELEVATION: 741.5	DEPTH	DEPTH (FT)	SAMPLE TYPE/NO	BLOWS/ 6-INCHES	STD. PEN RESIST (N)	REC (in)	FIELD TEST (ppm)	MOIST CONTENT (%)	DRY DENSITY (PCF)	UNCONF. COMP ST (PSF)				
740		731.0	FILL: Very Stiff to Hard Brown SILTY CLAY with Trace Sand and Gravel	10.5		LS-1	8 17 24	41	12.5				8000*				
					5	LS-2	6 9 9	18	11					6000*			
735						10	LS-3	5 12 12	24	18					8000*		
						10.5	10	LS-4	3 7 14	21	12					3000*	
730						728.0	FILL: Stiff Brown and Gray SANDY CLAY with Little Silt and Gravel (Petroleum Odor and Organics Noted)	13.5		LS-5	3 4 5	9	11.5		29.7	92.8	1640
							Medium Compact to Compact Gray SAND with Trace Silt and Gravel		15	LS-6	3 2 5	7	9.5				-
725						721.5	20.0	20	LS-7	14 28 20	48	18					-
			END OF BORING AT 20.0 FEET.														
720																	
715																	
710																	

Total Depth: 20 FT
Drilling Date: 2/3/09
Inspector: M. Flanagan
Contractor: American Drilling and Testing Co.
Driller: M. Abney
Drilling Method: CME 55 ATV drilling advancing 2-1/4" diameter HSA to EOB.

Water Level Observation:
 Groundwater encountered at 14.5' during drilling and at 11.6' upon completion of drilling.

Notes:
 * = pocket penetrometer value

Plugging Procedure:
 Borehole backfilled with soil cuttings.

GPS Coordinates:

LOG OF TEST BORING 15-050510-00.GPJ NTH CORPORATE NEW GDT 12/3/09

LOG OF TEST BORING NO: TB-606



NTH Consultants, Ltd.

Project Name: *Ann Arbor Wastewater Treatment Plant*

NTH Proj. No.: 15-050510-12

Project Location: *Ann Arbor, Michigan*

Checked By: *[Signature]*

SUBSURFACE PROFILE					SOIL SAMPLE DATA							
ELEV. (FT)	PRO-FILE	ELEV	DEPTH	DEPTH (FT)	SAMPLE TYPE/NO.	BLOWS/ 6-INCHES	STD. PEN RESIST. (N)	REC (in)	FIELD TEST (ppm)	MOIST CONTENT (%)	DRY DENSITY (PCF)	UNCONF. COMP ST (PSF)
			GROUND SURFACE ELEVATION: 742.0									
		741.6	TOPSOIL: Medium Brown SANDY CLAY									
740					LS-1	10 22 25	47	8				>9000*
		738.5										
					LS-2	7 9 10	19	2				-
		735.5										
735					LS-3	3 4 5	9	9				4000*
					LS-4	9 16 12	28	10				8000*
730												
		727.5										
					LS-5	2 2 3	5	10				500*
725		725.0										
					LS-6	7 8 9	17	14				-
720		721.0										
					LS-7	9 16 20	36	14				>9000*
		717.0										
			END OF BORING AT 25.0 FEET.									
715												
710												

Total Depth: 25 FT
Drilling Date: 3/24/09
Inspector: S. Gole
Contractor: American Drilling and Testing Co.
Driller: M. Abney
Drilling Method:
 CME 550X all terrain mounted drill rig using 2-1/4" ID HSA to EOB.

Water Level Observation:
 Groundwater encountered at 15' during drilling. Groundwater measured at 16' upon the completion of drilling.

Notes:
 * = pocket penetrometer value

Plugging Procedure:
 Borehole backfilled with cuttings.

GPS Coordinates:

Figure No. 3

LOG OF TEST BORING 15-050510-12.GPJ NTH CORPORATE NEW.GDT 12/3/09

ATTACHMENTS

CITY OF ANN ARBOR
LIVING WAGE ORDINANCE DECLARATION OF COMPLIANCE

The Ann Arbor Living Wage Ordinance (Section 1:811-1:821 of Chapter 23 of Title I of the Code) requires that an employer who is (a) a contractor providing services to or for the City for a value greater than \$10,000 for any twelve-month contract term, or (b) a recipient of federal, state, or local grant funding administered by the City for a value greater than \$10,000, or (c) a recipient of financial assistance awarded by the City for a value greater than \$10,000, shall pay its employees a prescribed minimum level of compensation (i.e., Living Wage) for the time those employees perform work on the contract or in connection with the grant or financial assistance. The Living Wage must be paid to these employees for the length of the contract/program.

Companies employing fewer than 5 persons and non-profits employing fewer than 10 persons are exempt from compliance with the Living Wage Ordinance. If this exemption applies to your company/non-profit agency please check here No. of employees__

The Contractor or Grantee agrees:

- (a) To pay each of its employees whose wage level is not required to comply with federal, state or local prevailing wage law, for work covered or funded by a contract with or grant from the City, no less than the Living Wage. The current Living Wage is defined as \$14.05/hour for those employers that provide employee health care (as defined in the Ordinance at Section 1:815 Sec. 1 (a)), or no less than \$15.66/hour for those employers that do not provide health care. The Contractor or Grantor understands that the Living Wage is adjusted and established annually on April 30 in accordance with the Ordinance and covered employers shall be required to pay the adjusted amount thereafter to be in compliance with Section 1:815(3).

Check the applicable box below which applies to your workforce

Employees who are assigned to any covered City contract/grant will be paid at or above the applicable living wage without health benefits

Employees who are assigned to any covered City contract/grant will be paid at or above the applicable living wage with health benefits

- (b) To post a notice approved by the City regarding the applicability of the Living Wage Ordinance in every work place or other location in which employees or other persons contracting for employment are working.
- (c) To provide to the City payroll records or other documentation within ten (10) business days from the receipt of a request by the City.
- (d) To permit access to work sites to City representatives for the purposes of monitoring compliance, and investigating complaints or non-compliance.
- (e) To take no action that would reduce the compensation, wages, fringe benefits, or leave available to any employee covered by the Living Wage Ordinance or any person contracted for employment and covered by the Living Wage Ordinance in order to pay the living wage required by the Living Wage Ordinance.

The undersigned states that he/she has the requisite authority to act on behalf of his/her employer in these matters and has offered to provide the services or agrees to accept financial assistance in accordance with the terms of the Living Wage Ordinance. The undersigned certifies that he/she has read and is familiar with the terms of the Living Wage Ordinance, obligates the Employer/Grantee to those terms and acknowledges that if his/her employer is found to be in violation of Ordinance it may be subject to civil penalties and termination of the awarded contract or grant of financial assistance.

 Company Name

 Street Address

 Signature of Authorized Representative

 Date

 City, State, Zip

 Print Name and Title

 Phone/Email address

CITY OF ANN ARBOR LIVING WAGE ORDINANCE

RATE EFFECTIVE APRIL 30, 2021 - ENDING APRIL 29, 2022

\$14.05 per hour

If the employer provides health care benefits*

\$15.66 per hour

If the employer does **NOT** provide health care benefits*

Employers providing services to or for the City of Ann Arbor or recipients of grants or financial assistance from the City of Ann Arbor for a value of more than \$10,000 in a twelve-month period of time must pay those employees performing work on a City of Ann Arbor contract or grant, the above living wage.

ENFORCEMENT

The City of Ann Arbor may recover back wages either administratively or through court action for the employees that have been underpaid in violation of the law. Persons denied payment of the living wage have the right to bring a civil action for damages in addition to any action taken by the City.

Violation of this Ordinance is punishable by fines of not more than \$500/violation plus costs, with each day being considered a separate violation. Additionally, the City of Ann Arbor has the right to modify, terminate, cancel or suspend a contract in the event of a violation of the Ordinance.

* Health Care benefits include those paid for by the employer or making an employer contribution toward the purchase of health care. The employee contribution must not exceed \$.50 an hour for an average work week; and the employer cost or contribution must equal no less than \$1/hr for the average work week.

The Law Requires Employers to Display This Poster Where Employees Can Readily See It.

**For Additional Information or to File a Complaint contact
Colin Spencer at 734/794-6500 or cspencer@a2gov.org**



Vendor Conflict of Interest Disclosure Form
--

All vendors interested in conducting business with the City of Ann Arbor must complete and return the Vendor Conflict of Interest Disclosure Form in order to be eligible to be awarded a contract. Please note that all vendors are subject to comply with the City of Ann Arbor’s conflict of interest policies as stated within the certification section below.

If a vendor has a relationship with a City of Ann Arbor official or employee, an immediate family member of a City of Ann Arbor official or employee, the vendor shall disclose the information required below.

1. No City official or employee or City employee’s immediate family member has an ownership interest in vendor’s company or is deriving personal financial gain from this contract.
2. No retired or separated City official or employee who has been retired or separated from the City for less than one (1) year has an ownership interest in vendor’s Company.
3. No City employee is contemporaneously employed or prospectively to be employed with the vendor.
4. Vendor hereby declares it has not and will not provide gifts or hospitality of any dollar value or any other gratuities to any City employee or elected official to obtain or maintain a contract.
5. Please note any exceptions below:

Conflict of Interest Disclosure*	
Name of City of Ann Arbor employees, elected officials or immediate family members with whom there may be a potential conflict of interest.	<input type="checkbox"/> Relationship to employee <hr/> <input type="checkbox"/> Interest in vendor’s company <input type="checkbox"/> Other (please describe in box below)

*Disclosing a potential conflict of interest does not disqualify vendors. In the event vendors do not disclose potential conflicts of interest and they are detected by the City, vendor will be exempt from doing business with the City.

I certify that this Conflict of Interest Disclosure has been examined by me and that its contents are true and correct to my knowledge and belief and I have the authority to so certify on behalf of the Vendor by my signature below:		
Vendor Name	Vendor Phone Number	
Signature of Vendor Authorized Representative	Date	Printed Name of Vendor Authorized Representative

CITY OF ANN ARBOR NON-DISCRIMINATION ORDINANCE

Relevant provisions of Chapter 112, Nondiscrimination, of the Ann Arbor City Code are included below.
You can review the entire ordinance at www.a2gov.org/humanrights.

Intent: It is the intent of the city that no individual be denied equal protection of the laws; nor shall any individual be denied the enjoyment of his or her civil or political rights or be discriminated against because of actual or perceived age, arrest record, color, disability, educational association, familial status, family responsibilities, gender expression, gender identity, genetic information, height, HIV status, marital status, national origin, political beliefs, race, religion, sex, sexual orientation, source of income, veteran status, victim of domestic violence or stalking, or weight.

Discriminatory Employment Practices: No person shall discriminate in the hire, employment, compensation, work classifications, conditions or terms, promotion or demotion, or termination of employment of any individual. No person shall discriminate in limiting membership, conditions of membership or termination of membership in any labor union or apprenticeship program.

Discriminatory Effects: No person shall adopt, enforce or employ any policy or requirement which has the effect of creating unequal opportunities according to actual or perceived age, arrest record, color, disability, educational association, familial status, family responsibilities, gender expression, gender identity, genetic information, height, HIV status, marital status, national origin, political beliefs, race, religion, sex, sexual orientation, source of income, veteran status, victim of domestic violence or stalking, or weight for an individual to obtain housing, employment or public accommodation, except for a bona fide business necessity. Such a necessity does not arise due to a mere inconvenience or because of suspected objection to such a person by neighbors, customers or other persons.

Nondiscrimination by City Contractors: All contractors proposing to do business with the City of Ann Arbor shall satisfy the contract compliance administrative policy adopted by the City Administrator in accordance with the guidelines of this section. All city contractors shall ensure that applicants are employed and that employees are treated during employment in a manner which provides equal employment opportunity and tends to eliminate inequality based upon any classification protected by this chapter. All contractors shall agree not to discriminate against an employee or applicant for employment with respect to hire, tenure, terms, conditions, or privileges of employment, or a matter directly or indirectly related to employment, because of any applicable protected classification. All contractors shall be required to post a copy of Ann Arbor's Non-Discrimination Ordinance at all work locations where its employees provide services under a contract with the city.

Complaint Procedure: If any individual believes there has been a violation of this chapter, he/she may file a complaint with the City's Human Rights Commission. The complaint must be filed within 180 calendar days from the date of the individual's knowledge of the allegedly discriminatory action or 180 calendar days from the date when the individual should have known of the allegedly discriminatory action. A complaint that is not filed within this timeframe cannot be considered by the Human Rights Commission. To file a complaint, first complete the complaint form, which is available at www.a2gov.org/humanrights. Then submit it to the Human Rights Commission by e-mail (hrc@a2gov.org), by mail (Ann Arbor Human Rights Commission, PO Box 8647, Ann Arbor, MI 48107), or in person (City Clerk's Office). For further information, please call the commission at 734-794-6141 or e-mail the commission at hrc@a2gov.org.

Private Actions For Damages or Injunctive Relief: To the extent allowed by law, an individual who is the victim of discriminatory action in violation of this chapter may bring a civil action for appropriate injunctive relief or damages or both against the person(s) who acted in violation of this chapter.

THIS IS AN OFFICIAL GOVERNMENT NOTICE AND
MUST BE DISPLAYED WHERE EMPLOYEES CAN READILY SEE IT.

MICHIGAN DEPARTMENT OF TRANSPORTATION CERTIFIED PAYROLL

COMPLETION OF CERTIFIED PAYROLL FORM FULFILLS THE MINIMUM MDOT PREVAILING WAGE REQUIREMENTS

(1) NAME OF CONTRACTOR / SUBCONTRACTOR (CIRCLE ONE) (2) ADDRESS

(3) PAYROLL NO. (4) FOR WEEK ENDING (5) PROJECT AND LOCATION (6) CONTRACT ID

(a)	(b)	(c)	(d) DAY AND DATE							(e)	(f)	(g)	(h)	(i)	(j) DEDUCTIONS					(k)			
			Hour Type													TOTAL HOURS ON PROJECT	PROJECT RATE OF PAY	PROJECT RATE OF FRINGE PAY	GROSS PROJECT EARNED		GROSS WEEKLY EARNED	TOTAL WEEKLY HOURS WORKED ALL JOBS	FICA
EMPLOYEE INFORMATION	WORK CLASSIFICATION									0			\$0.00									\$0.00	\$0.00
NAME:										0			\$0.00									\$0.00	\$0.00
ETH/GEN: ID #: GROUP/CLASS #:		S								0			\$0.00									\$0.00	\$0.00
NAME:										0			\$0.00									\$0.00	\$0.00
ETH/GEN: ID #: GROUP/CLASS #:		S								0			\$0.00									\$0.00	\$0.00
NAME:										0			\$0.00									\$0.00	\$0.00
ETH/GEN: ID #: GROUP/CLASS #:		S								0			\$0.00									\$0.00	\$0.00
NAME:										0			\$0.00									\$0.00	\$0.00
ETH/GEN: ID #: GROUP/CLASS #:		S								0			\$0.00									\$0.00	\$0.00
NAME:										0			\$0.00									\$0.00	\$0.00
ETH/GEN: ID #: GROUP/CLASS #:		S								0			\$0.00									\$0.00	\$0.00
NAME:										0			\$0.00									\$0.00	\$0.00
ETH/GEN: ID #: GROUP/CLASS #:		S								0			\$0.00									\$0.00	\$0.00
NAME:										0			\$0.00									\$0.00	\$0.00
ETH/GEN: ID #: GROUP/CLASS #:		S								0			\$0.00									\$0.00	\$0.00
NAME:										0			\$0.00									\$0.00	\$0.00

DETAILED SPECIFICATIONS